



2019/2020

THE LEADER IN PROCESSING



SEASONING FOR ALL

SEE PAGES 47-50 FOR OUR ENTIRE ASSORTMENT OF SEASONING

BIG BITE® COMMERCIAL QUALITY MEAT SLICERS



Big Bite® Commercial Quality Meat Slicers

Commercial grade performance for your home or business. These semi-automatic electric meat slicers sport a powerful induction motor and high torque belt drive to satisfy any use. Large capacity tilted food carriage glides effortlessly across a stainless steel blade for deli quality cuts 1mm-10mm thick. Solid metal food pusher with teeth delivers precise control while keeping fingers away from the blade. Graduated knob controls thickness. Built in blade sharpener. Sturdy cast aluminum housing. Check out our full line of meat slicers on page 21. **ETL Certified. 5 Year Warranty.**

#1185 — \$369.99 (add \$6.00 extra for shipping)

#1020 — \$429.99 (add \$6.00 extra for shipping)

LEM HAS EXACTLY WHAT YOU NEED | CASINGS FOR ANY TYPE OF SAUSAGE

GO TO PAGES 18-19 TO SHOP ENTIRE ASSORTMENT OF CASINGS



High Temperature Cheese

This 100% real cheese is specially formulated to retain its shape and flavor up to 400°F. Pre-cut to ¼" chunks. Just add to your meat in a one to ten ratio (1 lb. cheese to 10 lbs. of meat) after the second grind, stuff and cook as usual. Cheese will last up to 12 months at 32–45°F and can be frozen. 1 lb. bag. Contains milk. Contains no gluten. Refrigerate upon receipt. **Sorry, cannot ship to Canada.**

#807 Cheddar \$10.49 #808 Hot Pepper \$10.49 #865 Swiss \$10.49 #1246 Habanero \$10.49



44 lb. Stainless Steel Scale

This reliable stainless-steel scale has an oversized steel platform, oversized 8" dial and will measure in ounces, pounds, grams, and kilograms. Sturdy stainless-steel construction is easy to wash or wipe down and looks great on any countertop. Includes easy to use tare function. #435 — \$61.99



11 lb. Digital Kitchen Scale

This 11 lb. Digital Kitchen Scale is an absolute necessity! Accurately weigh special ingredients for recipes or food portions for special diets. Easy to clean sleek glass top. The easy-to-read digital scale measures up to 11.3 pounds/5 kilograms by .1 oz/1 gram increments. Zero adjusting tare function. #1193A — \$25.79



Sausage and MeatLoaf Seasoning

Backwoods custom blended meat loaf seasoning brings together just the right balance of sage, salt, and coriander for a taste just like mom's. Try it as a sausage seasoning for a balanced homestyle flavor you won't soon forget. Instructions for meatloaf and sausage on the back of the package. Comes in 6 oz and 24 oz pouches. An absolute customer favorite!

#9150 makes up to 24 lbs. — \$4.99

#9151 makes up to 96 lbs. — \$11.99

MIGHTY BITE[®]

POWERFUL PERFORMANCE



#8 Mighty Bite Grinder

Mighty Bite is the perfect grinder for anyone interested in getting into grinding and sausage making. Long-lasting metal gears and durable aluminum construction ensure it will make quick work on everything wild or tame for seasons to come.

Features:

- Multi-speed, 500 watt motor
Full power for grinding
Slow speed for stuffing
- Pulse reverse
- Oversized hole in pan and neck allows for larger pieces of meat to be fed to the auger
- Three SS plates (3/16", 3/8", stuffing)
- One way stainless steel knife
- Three plastic stuffing tubes (1/2", 1" 13/8" O.D.)
- 5' cord stored under housing
- Handwash only

Two Year Warranty

ETL Certified

#1158 — \$239.99



WARNING:
Cancer and/or
Reproductive Harm
www.p65warnings.ca.gov



#8 Countertop Grinder

The 575-watt motor has push button forward and pulse reverse functionality. Heavy-duty aluminum #8 head assembly locks with a quarter turn and has a push button release. Will grind up to three pounds per minute. Includes stainless steel knife, plus two stainless steel plates (8 mm, 4.8 mm), meat stomper, 7/8" O.D. plastic stuffing tube and plastic stuffing plate. Handwash only. **ETL Certified.**

#1224 — \$124.99

Juicer/Strainer Grinder Attachment

#1187 — \$32.99 *Item not pictured*



More info & options at
LEMproducts.com



BIG BITE GRINDER

BIG BITE GRINDER ATTACHMENTS

(Sold Separately)



Dual Grind Attachments

#1472, see page 08

#1473, see page 08



Mixers - Tilt and Fixed Position

25 lb. Fixed Mixer #1733, see page 10

25 lb. Tilt Mixer #1869, see page 10

50 lb. Fixed Mixer #1734, see page 10

50 lb. Tilt Mixer #1868, see page 10



2-in-1 Jerky Slicer & Tenderizer Attachment

#433TJ, see page 09

#433T, see page 09

#433J, see page 09



Juicer Attachment

#1227, see page 08



Auto Patty Maker Attachment

#687, see page 09



Patty, Jerky & Snack Stick Maker

#517, see page 09



Grinder Foot Switch

#724, see page 06



Ground Meat Packaging System

#200 Series, see page 26

THE SECRET TO FASTER GRINDING

Our revolutionary Big Bite® Grinders come equipped with improved speed and performance that delivers a premium grind in half the time. The rifled head design and advanced Big Bite® technology, offer a superior second grind, while virtually eliminating stomping and vastly improving the sausage stuffing function. We believe in this grinder so much that we extended the warranty to five years.



#5

0.35 HP 4 lbs./min
OCCASSIONAL USE

#1777 — \$299.99
(add \$6.00 extra shipping)

#8

0.50 HP 7 lbs./min
REGULAR USE

#1779 — \$349.99
(add \$7.00 extra shipping)



PREMIUM

ACCESSORIES INCLUDED:

- 1 Stainless Steel Meat Pan
 - 1 Stainless Steel Knife
 - 2 Stainless Steel Grinder Plates
 - 3/8" (10 mm) — Coarse grind
 - 3/16" (4.5 mm) — Fine grind
 - Stuffing Plate
 - 1 Plate Extractor
- (Plate extractor is not included with the #5 grinder)*



5 YEAR WARRANTY

LIFETIME CUSTOMER SUPPORT

LEM's 5 Year Warranty on parts and labor is unprecedented in the industry. Our skilled technicians and extensive parts inventory are available for customer support after the sale.



WARNING: Cancer and/or Reproductive Harm
www.p65warnings.ca.gov

FEATURES:

- Large stainless steel meat pan
- All stainless steel motor housing
- Recessed storage drawer
- Heavy duty handle for easy moving
- Noise dampening design for quieter performance
- All-metal gears with roller bearings



LESS OBSTRUCTIVE SAFETY GUARD

FOR #22 & #32 GRINDERS ONLY

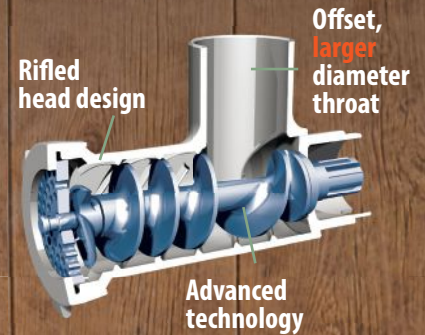

#12

0.75 HP 11 lbs./min
FREQUENT USE

#1780 — \$479.99
(add \$7.00 extra shipping)

#22

1.0 HP 13 lbs./min
HEAVY USE

#1781 — \$629.99
(add \$7.00 extra shipping)

#32

1.5 HP 17 lbs./min
PROFESSIONAL USE

#1782 — \$799.99
(add \$7.00 extra shipping)

GRIND HALF THE TIME

ALL THE GRINDER ACCESSORIES YOU NEED



C. CUSTOMER FAVORITE! Grinder Foot Switch

Grind hands-free! Just plug grinder into pedal, then plug the pedal into 110 V outlet. Works great with LEM's Ground Meat Packaging System or when stuffing casings from your grinder. Cord length 8'. **UL Listed.**

#724 — \$41.99



D. Meat Grinder Covers

Protect your grinder when not in use. Heavy duty vinyl. Easy-to-clean.

Covers LEM Big Bite Grinders: 5, 8, 12

#648A 21" L x 11" W x 1 1/2" H
\$17.99



Covers LEM Big Bite Grinders: 22, 32

#650A 25" L x 14" W x 19" H \$21.99

E. LEM Food Grade Silicone Spray

Protect all the metal parts on your grinders, stuffers, saws, knives, etc. Lubricates without build up, repels water, and provides a protective coating. Odorless, non-toxic, tasteless. Okay for incidental food contact. *Sorry, express shipping not available. Cannot ship outside the Contiguous U.S. or to California.* #213 11 oz. Can \$11.99

F. PürGel Klear

Use Food Safe Lubricant to keep your equipment in top condition. This NSF Approved lubricant will keep your equipment running at peak performance. Approved for use where direct contact with food is likely. #1067 8 oz. Tube \$11.49

G. 1700 Series Grinder Stompers

Keep hands and fingers away from your grinder's moving parts.

#01007007 for Grinder #5 \$7.99

#01007008 for Grinders #8 & #12 \$7.99

#01007011 for Grinders #22 & #32 \$7.99

H. Grinder Plate and Knife Extractor

Quickly and safely extract plates and knives from your grinder head using the long curved hook of this extractor. 7 1/2" total length. 3 1/4" plastic handle.

#1194 — \$9.49



E F G H

#1194 — \$9.49

E F G H

#1194 — \$9.49

E F G H

#1194 — \$9.49

E F G H

#1194 — \$9.49

“Makes grinding and stuffing a breeze. Great investment.” — Jim H.

A. Grinder Cleaning Kit WITH 10 BRUSHES

Keep your grinder and accessories looking like new. Kit includes 3" diameter brush for cleaning the head, nine small brushes for cleaning grinding plates and stuffing tubes and an 11 oz. can of food grade silicone spray to lubricate and prevent rust.

#686 — \$21.99

Sorry, express shipping not available. Cannot ship outside the contiguous U.S. or to California.

#686B Without Silicone Spray \$14.69

#580 Large Brush only \$5.19



A

BUY TOGETHER AND SAVE!

Grinder Accessory Kit

Kit contains: Poly Bag Tape Machine & Tape, 50-1 lb. Wild Game Bags, Grinder Foot Switch, and Grinder Cleaning Kit (shown above).

Sorry, express shipping not available. Cannot ship outside the contiguous U.S. or to California.

#819 — \$82.99



B. Customer Favorite! Stuffing Tube Cleaning Brush

The dual-heads make quick work of cleaning and unclogging your stuffing tubes. 12" long with 1/2" and 1 1/8" heads.

#1360 — \$9.99

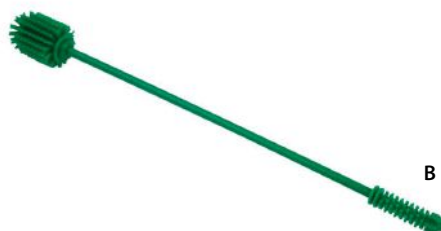

B

GRINDER REPLACEMENT PARTS

Made to LEM's stringent standards for hardness and quality, our stainless steel plates and knives last longer than carbon and are highly resistant to rust. All plates are hubless so they can be used on either side. Replace knife and plate at the same time for optimum performance.

Grinder Stainless Steel Stuffing Tubes

These stainless steel tubes are made for easy clean-up and long-lasting performance.

Grinder	Size	SKU #	Price
#5	1/2"	#547ASS	\$15.49
	3/4"	#547SS	\$15.49
	7/8"	#547CSS	\$15.49
#8	1/2"	#553SS	\$15.49
	3/4"	#554SS	\$15.49
	7/8"	#543CSS	\$15.49
#10/12	1/2"	#543DSS	\$15.49
	1/2"	#055ASS	\$15.99
	3/4"	#055BSS	\$15.99
#20/22	7/8"	#055CSS	\$15.99
	1 1/4"	#055DSS	\$15.99
	1/2"	#056ASS	\$20.99
#32	3/4"	#056BSS	\$20.99
	7/8"	#056CSS	\$20.99
	1 1/4"	#056DSS	\$20.99
	1/2"	#057ASS	\$20.99
	3/4"	#057BSS	\$20.99
	7/8"	#057CSS	\$20.99
	1 1/4"	#057DSS	\$20.99



Grinder Knives



	STAINLESS STEEL		PREMIUM STAINLESS STEEL	
	SKU#	Price	SKU#	Price
#5	#464SS	\$11.99	NOT AVAILABLE	
#8	#346SS	\$13.99	#346SS-SAL	\$21.99
#10/12	#485SS	\$16.99	NOT AVAILABLE	
#20/22	#486SS	\$19.99	#486SS-SAL	\$28.99
#32	#487SS	\$21.99	#487SS-SAL	\$43.49



Grinder Plates



		STAINLESS STEEL		PREMIUM STAINLESS STEEL	
		SKU#	Price	SKU#	Price
#5 2 1/8" Dia.	3 mm	#464CSS	\$12.99	#464CSS-SAL	\$16.99
	4.5mm	#464ASS	\$12.99	#464ASS-SAL	\$16.99
	6 mm	#788SS	\$12.99	#788SS-SAL	\$16.99
	10 mm	#464BSS	\$12.99	#464BSS-SAL	\$16.99
	STUFFING	#787SS	\$12.99	NOT AVAILABLE	
#8 2 3/8" Dia.	3 mm	#343SS	\$17.99	#343SS-SAL	\$24.49
	4.5 mm	#344SS	\$17.99	#344SS-SAL	\$24.49
	6 mm	#473SS	\$17.99	#473SS-SAL	\$24.49
	10 mm	#345SS	\$17.99	#345SS-SAL	\$24.49
	12 mm	#474SS	\$17.99	#474SS-SAL	\$24.49
	STUFFING	#610SS	\$17.99	NOT AVAILABLE	
#10/12 2 3/4" Dia.	3 mm	#347SS	\$20.99	#347SS-SAL	\$25.99
	4.5 mm	#046SS	\$20.99	#046SS-SAL	\$25.99
	6 mm	#475SS	\$20.99	#475SS-SAL	\$25.99
	10 mm	#047SS	\$20.99	#047SS-SAL	\$25.99
	12 mm	#476SS	\$20.99	#476SS-SAL	\$25.99
	STUFFING	#489SS	\$20.99	NOT AVAILABLE	
#20/22 3 1/4" Dia.	3 mm	#348SS	\$22.99	#348SS-SAL	\$31.49
	4.5 mm	#049SS	\$22.99	#049SS-SAL	\$31.49
	6 mm	#477SS	\$22.99	#477SS-SAL	\$31.49
	10 mm	#050SS	\$22.99	#050SS-SAL	\$31.49
	12 mm	#478SS	\$22.99	#478SS-SAL	\$31.49
	STUFFING	#490SS	\$22.99	NOT AVAILABLE	
#32 3 7/8" Dia.	3 mm	#376SS	\$34.99	#376SS-SAL	\$45.99
	4.5 mm	#052SS	\$34.99	#052SS-SAL	\$45.99
	6 mm	#481SS	\$34.99	#481SS-SAL	\$45.99
	10 mm	#053SS	\$34.99	#053SS-SAL	\$45.99
	12 mm	#482SS	\$34.99	#482SS-SAL	\$45.99
	STUFFING	#491SS	\$34.99	NOT AVAILABLE	

NEW! Big Bite Dual Grind Attachment

Save time with two grinds in one pass. This innovative technology has been used in commercial processing for years, we're bringing it to home processing! The double edge grinding knife and 2 grinding plates produce the consistency of two grinds in a single pass through the grinding head.

#1472 #8/#12 Dual Grind Attachment **\$149.99**
 #1473 #22/#32 Dual Grind Attachment **\$219.99**

SAVE TIME WITH 2 GRINDS IN ONE PASS

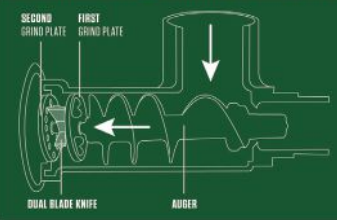

Works with LEM Big Bite Grinder motors #8/#12/#22/#32 made after 2009. Motor not included.



Non-Stick Drying Sheets

Simply cover trays with a drying sheet to dry fruit pulps for fruit rolls, jerky, juices, herbs and garlic. 36 per pack, disposable, one-time use.
 #1199 — **\$10.99**

Reusable Cooking Sheet

Ideal for drying and cooking. The reusable and reversible cooking sheets are non-stick and easy to clean. 15.75" x 26".
 #1191 — **\$14.99**



Big Bite Juicer Attachment

Now you can use your Big Bite Grinder to easily make fresh juice, puree, baby food, tomato sauce, jam, or jelly without the hassle of peeling or seeding fruits or vegetables! Stainless steel head and screen for increased durability. The screen has a rubber plug and graduated holes to maximize juice extraction on the first pass.
Two Year Warranty. Fits all Big Bite grinders (after 2009).
 Motor not included. #1227 — **\$119.99**

Big Bite Juicer Screens

Make salsa and jellies or use to get a high yield. Salsa Screen - ¼" holes, Berry Screen - ⅛" holes, High Yield Screen - ⅜" holes with smaller waste outlet.
 #1422 Set of three — **\$35.99**



3-IN-1 BURGER, SNACK STICK & JERKY ATTACHMENT

3-in-1 Grinder Attachment

Make patties, jerky and snack sticks right from your grinder. Attach unit to grinder before you start the second grind. Thread waxed paper (included) onto the chute and start processing. Makes 1/2" thick x 4" patties or 3/8" thick patties. Can also make jerky strips or snack sticks, always uniform in size for even drying. Use the 11" meat shears, (included, not shown) to cut the meat to any length. **Two Year Warranty. Fits most #5, #8, #12, #22 & #32 size electric grinders.**

#517 — \$142.99

#265D Extra Wax Paper Roll (4 1/2" x 240') \$12.99



More info & options at
LEMproducts.com



HANDS-FREE PATTY MAKING RIGHT FROM YOUR GRINDER!

Auto Patty Maker Attachment

Attach the patty maker to your grinder and watch the patty form through the clear top. When the patty well is full, slide the tray to the other side, patty falls out onto your patty paper, and a second patty starts to form in the adjacent patty well. Makes 4" patties 3/4" thick. Fits most #8, #12, #22 and #32 size electric grinders. All poly construction makes clean up a breeze. **Two Year Warranty.**

#687 — \$59.99



2-in-1 Jerky Slicer & Tenderizer Attachment

Slice meat up to 1/4" thick for 14 perfect jerky strips sliced and ready for the oven or dehydrator in seconds. Remove the easy-off top; replace the slicer shaft with the tenderizer shaft and tenderize even the toughest cuts of meat. Body is made of durable powder painted aluminum. Easily disassembles for clean up. No tools or assembly required. Chute dimensions 4 1/2" L x 1 1/4" W x 8" H. **Two Year Warranty.**

#433TJ — \$289.99

Motor not included. Fits all LEM stainless steel grinder sizes #5, #8, #12, #22, #32 (except 2001 and earlier). Does not fit LEM grinder model #1113, 1158, 1182, 1224 or past years kitchen grinders.



Jerky Slicer Attachment Only

Does NOT Include Tenderizer Driven Shaft & Blades.
#433J — \$209.99

Tenderizer Attachment Only

Does NOT Include Jerky Slicer Driven Shaft & Blades.
#433T — \$209.99

BEST SELLER! Heavy Duty Meat Lug

Smooth interior for easy clean-up. Reinforced handles. Ribs on top and bottom add extra strength for extended life. Holds up to 50 lb. 21.75" x 15.5" x 7". White Lid sold separately. **NSF Certified. Made in USA.**

#360 white — \$16.99



More info & options at
LEMproducts.com





B. Mighty Bite® Manual 20 lb. Mixer

Simply put the seasonings, water and meat into the hopper and turn the handle. Mixes in just minutes. Easy-to-clean and rust-resistant. Includes clear, acrylic cover. **Two Year Warranty.**

#654 Tub measures 11" x 8¾" x 11" **\$189.99** (add \$4.00 extra shipping)

A. Improved! Big Bite® Fixed Position Mixers*

Available in two sizes: 25 lb. and 50 lb.
Removable tub for cleaning.

25 lb. Mixer will attach to any LEM stainless steel grinder #8 head size or larger. Handle and clear, acrylic cover included. **Two Year Warranty.**

#1733 Tub measures 10 ¾" x 10" x 12" **\$349.99** (add \$8.00 extra shipping)

50 lb. Mixer will attach to any LEM stainless steel grinder #12 head size or larger. Handle and clear, acrylic cover included.

#1734 Tub measures 13 ½" x 10 ¾" x 14 ½" **\$399.99** (add \$8.00 extra shipping)

Two Year Warranty.



*New one piece tub design and removable tub.

Meat Grinders sold separately

*Will only attach to LEM stainless steel grinders sold after 2009.

MEAT MIXERS FOR THE BIG JOBS



Big Bite® Tilt Mixers*

- Tub has 3 locking positions: mixing, dumping and storing
- Fully removable meat tub for easy clean up
- High performance roller bearings for extended life
- Universal drive shaft allows mixers to attach to any current LEM stainless steel grinders sold after 2009
- Handle for manual use
- Acrylic cover included

Two Year Warranty

25 lb. Tilt Mixer

25 lb. will attach to any LEM stainless steel grinder #8 head size or larger.

#1869 Tub measures 10 ¾" x 10" x 12" **\$439.99** (add \$8.00 extra shipping)

50 lb. Tilt Mixer

50 lb. will attach to any LEM stainless steel grinder #12 head size or larger.

#1868 Tub measures 13 ½" x 10 ¾" x 14 ½" **\$499.99** (add \$8.00 extra shipping)

*Removable tub.



Tilt to unload



Flip 180° for easy storage



Meat Grinders sold separately

*Will only attach to LEM stainless steel grinders sold after 2009.

A word on Meat Mixers:

Once your meat has been ground, seasonings must be blended with the meat before you load it into a sausage stuffer. Mixers make quick work of this process; evenly blending the seasonings in half the time a person could mix by hand.



MAXVAC[®] PRO

EASILY SEALS AND PROTECTS LIQUIDS



NEW! MaxVac[®] Pro Chamber Vacuum Sealer

Digital controls and 3 preset functions. The MaxVac[®] Pro Chamber Vacuum Sealer locks in freshness and extends the shelf life of your food. This commercial-grade chamber vacuum sealer handles large quantities of meat, game, vegetables, fish, casseroles, soups, or everyday leftovers. Keep your game and meat fresh longer. Digital design and 3 customizable presents make it easy to use. Heavy-duty stainless steel housing and dual sealing elements. Now with a flat top, no wires, and removable seal bar for easy cleaning. Includes 80 bags. **Five Year Warranty. #1380 — \$999.99**



MaxVac[®] Pro Chamber Sealer Bags

Shield food from freezer burn and dehydration, keeping food fresh longer. Freeze, refrigerate, microwave, boil, or cook sous vide! Compatible with chamber vacuum sealers. **Will NOT work with suction-type vacuum sealers.**

#1258 250 ct.—6" x 9" bags \$29.99

#1259 250 ct.—8" x 10" bags \$45.00

#1260 250 ct.—10" x 13" bags \$62.99



A



B

MAXVAC®



C

EXTEND THE LIFE OF YOUR FOODS

A. MaxVac® 500 Vacuum Sealer

Seals up to 450+ times continuously! The perfect vacuum sealer for the frequent user lets you seal for 5+ hours nonstop. Will extend the freezer life of your food. Its powerful vacuum and 1-hand locking mechanism makes this easy to use. Seal in the freshness and nutrients while protecting against freezer burn. 14" seal bar. 1/4" wide seal bar. Includes 8" x 25' roll of bag material. **Two Year Warranty. Compatible with most national brand vacuum bags. ETL Certified.**
#1253 — \$309.99

B. MaxVac® 1000 Vacuum Sealer

1000+ consecutive seals without stopping! That's over 10 hours of nonstop sealing with this workhorse sealer. Removes air and automatically seals to extend the freshness of any food. This stainless steel sealer is built to last with its 14" seal bar, 1/4" wide seal. The strong seal is perfect for reducing marinating time, keeping valuables airtight and dry, or extending freshness of foods. **Includes 8" x 25' roll of bag material. Five Year Warranty. Compatible with most national brand vacuum bags. ETL Certified.**
#1088B — ~~\$469.99~~ \$399.99
*Special Price Now through January 2020.
*Item discount not eligible with other promotions.

C. NEW! MAXVAC® 250 VACUUM SEALER

This powerful vacuum sealer will extend the freshness and freezer life of your favorite foods. A built-in continuous run fan allows you to seal for up to 2.5 hours without stopping or cooling down. Stainless steel construction is countertop friendly and built to last. 1-handed locking lid makes it easy to use. Detachable cord. Compatible with most national brand vacuum bags. **One Year Warranty. Lifetime customer support. ETL certified.**

#1393 — \$199.99



D. MaxVac Vacuum Sealer Bags

Our innovative parallel channel design prevents hidden air pockets with sturdy 3.5 mil puncture-resistant plastic. All bags include a space to label the date/contents and are compatible with most major vacuum sealer brands and have an easy open tear notch.

- #1230 100 ct. – Pint Bags 6" x 9" **\$25.99**
- #1386 **NEW** 28 ct. – Pint Bags **\$9.99**
- #1089 100 ct. – Quart Bags 8" x 12" **\$35.99**
- #1387 **NEW** 44 ct. – Quart Bags **\$19.99**
- #1090 100 ct. – Gallon Bags 11" x 16" **\$56.99**
- #1388 **NEW** 28 ct. – Gallon Bags **\$19.99**
- #1382 **NEW** 36 qt. – Bags, (2) 8" x 25' & (2) 11" x 25' rolls **\$49.99**



More info & options at LEMproducts.com

E. Roll Storage & Cutter

Easily make unique size bags with this roll holder & cutter. Compatible with #1088, #1088A and #1379 or use free standing. Holds up to 14" x 50' roll.
#1252 — **\$30.99**

F. Bag Roll Material

Roll material allows you to customize bag size to perfectly fit the food you are sealing - reducing bag waste and saving you money. Bags and bag roll material are reusable and include a space to label the date/contents.
#1389 **NEW** Bag Material Roll, 2 Rolls – 8" x 20' **\$19.99**
#1390 **NEW** Bag Material, 2 Rolls – 11" x 16' **\$19.99**
#1391 **NEW** Bag Material, 2 Rolls – 14" x 20' **\$29.99**



NEW! MaxVac® 100 Vacuum Sealer

The perfect countertop sealer to handle all your sealing needs. Sealer will do 26 consecutive seals and has a 12" seal bar and stainless steel top.
ETL Certified. #1379 — \$89.99

G. Zipper Vacuum Sealer Bags

Zipper closure lets you re-use the bag after sealing.
#1254 100 ct. – Quart Bags 8" x 12" **\$41.99**
#1255 100 ct. – Gallon Bags 11" x 16" **\$64.99**

H. Absorbent Pads for Vacuum Bags

The soaker pad will prevent moisture from gathering and allow the sealer to do its job without limitation. A must for sealing high moisture foods.
#1220 250 ct. – 4½" x 7" **\$10.49**



I. Hands-Free Bag Holder

This essential rack holds storage bags securely open for hands-free filling. Adjustable arms telescope to 10" to accommodate pint, quart and gallon bags. Stores flat.
#1186 — **\$7.49**



J. Vacuum Bag Platform

Allows for hands-free support while sealing. Multi use, cutting board top. 15.7" x 11.8" x 2".
#1257 — **\$25.99**



MAKE YOUR OWN DELICIOUS TREATS

BPA FREE/FDA Approved



Mighty Bite® Dehydrators with digital display

The perfect size dehydrators are now even better! With see-through doors, you can monitor the progress of your food without opening the door and losing heat. Both the 5 and 10 tray dehydrators have rear-mounted fans to improve drying time efficiency. A 30-hour digital timer with auto shut-off means you can set it and forget it. Each tray allows for 360° rotation and uniform drying. Rigid aluminum reinforced corners support the sturdy plastic housing. The removable drip tray makes for an easy clean-up. Temp. range 0-155 degrees.

A. Mighty Bite® 770 Watt 10-Tray Dehydrator

Has up to 15 sq. ft. of drying space and comes with removable doors. The double door design reduces unnecessary outflow of heat resulting in faster drying time. **Two Year Warranty. ETL Certified.**

#1153 — \$189.99 (add \$9.00 extra shipping)

B. Mighty Bite® 550 Watt 5-Tray Dehydrator

Has up to 7.5 sq. ft. of drying space with a removable door. **Two Year Warranty. ETL Certified.**

#1152 — \$139.99 (add \$5.00 extra shipping)

 WARNING: Cancer and/or Reproductive Harm
www.p65warnings.ca.gov

DEHYDRATOR ACCESSORIES



Non-Stick Drying Sheets

Cover your trays with a drying sheet to dry fruit pulps, for fruit rolls, jerky, juices, herbs and garlic. Discard for easy cleanup. Heat tolerance of up to 400°F on a baking sheet. Great for catching the drippings at the bottom of your dehydrator. 36 per pack. 14" x 14". Disposable—one-time use. #1199 — \$10.99



Reusable Cooking Sheet

Ideal for drying and cooking! Use in your dehydrator to make fruit rolls, or dry foods such as herbs or berries. The reusable and reversible cooking sheets are non-stick and easy to clean. Cut to size. Heat resistant to 500°F. 15¾" x 26". #1191 — \$14.99



Drying Screen Material for use with Dehydrators

Use for drying smaller fruits and vegetables. Custom cut it to the size you need. Non-stick, reusable polypropylene composite with 1/8" holes. Heat resistant up to 194°F. Dishwasher safe. **FDA Approved.** 84"x14" #796A — \$15.29

STAINLESS STEEL TRAYS AVAILABLE ONLY AT LEM!

Control panel with digital display

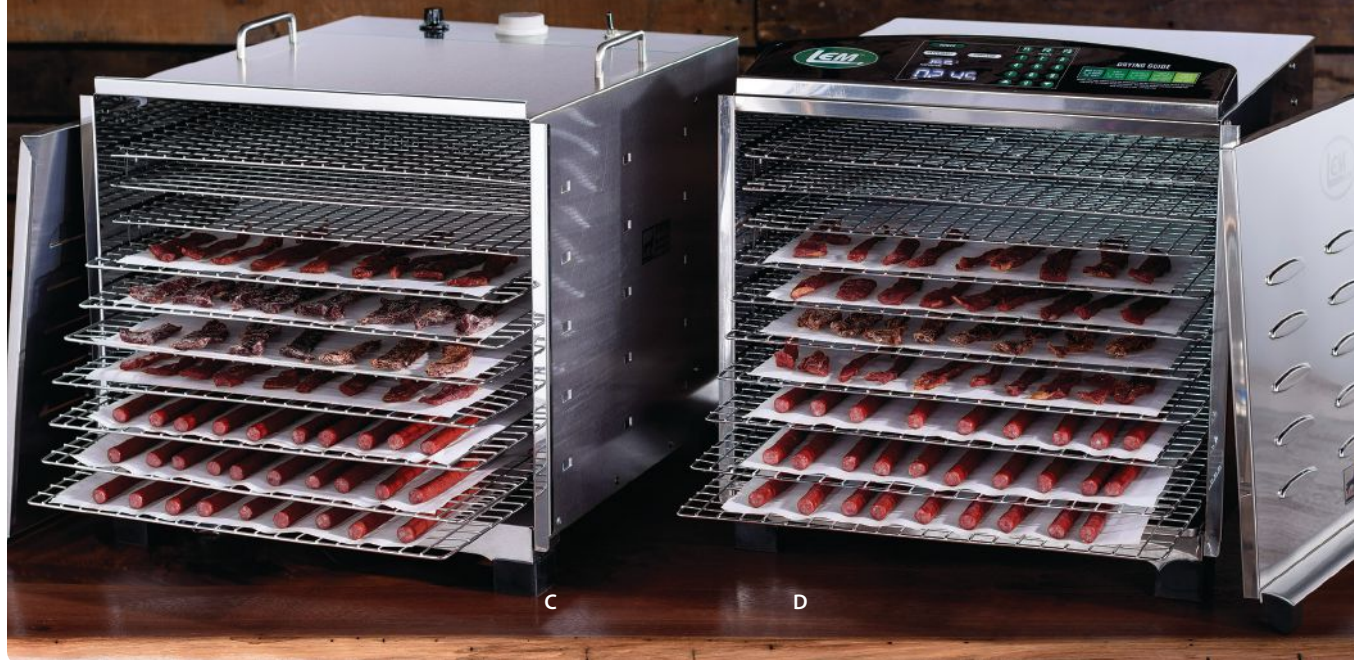

C. Big Bite® Dehydrator with 12-Hour Timer

High capacity food dryer with an immense 16 sq. ft. of drying area! Ten chrome plated (or stainless steel) trays let you make mountains of jerky, sticks or other dried delicacies in a single sitting. The horizontal air flow design is powered by a whisper quiet rear mounted 770 watt fan and heating system for uniform drying. A twelve-hour analog timer and adjustable thermostat lets you dry foods at just the right temperature and duration for maximum nutrition and flavor. Stainless steel housing. Temp. range 90-150 degrees. **Five Year Warranty. ETL Certified.**

- #778A Chrome Plated Trays with 3/4" holes **\$299.99** (add \$10.00 extra shipping)
- #778ASS Stainless Steel Trays with 1/4" holes **ONLY AT LEM \$339.99** (add \$10.00 extra shipping)
- #04057008 Stainless Steel Drip Tray **\$14.49**

D. Big Bite® Digital Dehydrator

This high capacity dehydrator has a digital display, making it simple to set and read time & temperature. Front panel has patented magnetic door design that slides and locks in place so you can add or remove trays with minimal heat loss. Contains 16 sq. ft. of drying area and 10 chrome plated (or stainless steel) trays, making it easy to make large quantities of jerky, snack sticks, or other dried delicacies. Trays have 1/4" holes to dry even the smallest fruits and herbs. Horizontal air flow system for uniform drying. 24-hour timer. Temp. range 90-155 degrees. 770 watt heating element. **Five Year Warranty. ETL Certified. Drip Tray Included.**

- #1154 Chrome Plated Trays with 1/4" holes **\$369.99** (add \$10.00 extra shipping)
- #1154SS Stainless Steel Trays with 1/4" holes **\$429.99** (add \$10.00 extra shipping)
- #778A10PK 10 Pack 1/4" holes Stainless Steel Trays **\$119.99**

LEM Dehydrator

This 5-tray dehydrator is perfect for making small batches. It has a 48-hour digital timer and preset temperatures. With the clear lid and body, you can easily monitor the progress of your dehydrating. The chimney-like center allows for better air flow and helps with uniform drying. Includes 5 mesh tray overlays for drying smaller items. **ETL Certified. BPA FREE.**

- #1378 Plastic Trays with 3/4" holes **\$79.99**



Mighty Bite® Sausage Stuffers

With 3 stainless steel tubes

A. 15 lb. Stuffer #1607SS — \$383.99

(add \$6.00 extra shipping)

B. 5 lb. Stuffer #1606SS — \$204.99

**AN LEM EXCLUSIVE
AVAILABLE
ONLY AT LEM!**



Mighty Bite® Sausage Stuffers

Now with protective gear cover. The precision machined carbon steel gears are manufactured to eliminate slippage and wear, and won't rust or collect germs. Cylinder is easily removed for clean-up. The hard plastic piston with built-in air release valve allows air to escape, making your job easier. These are reliable, high performance, gear-driven stuffers that will last. This innovation takes safety and durability to the next level by ensuring your gears and your food are well protected. For tube sizes, see bottom of page 17. **Two Year Warranty.**



Cheese Press Adapter

Make Cheese using your LEM 5 lb. Mighty Bite Stuffer with this nifty adapter

Use your Mighty Bite 5 lb. Sausage Stuffer as a cheese press with this simple adapter. Slide the SS cylinder and hard plastic base into the frame of your stuffer and start making cheese! Holds 1-2 gallons of milk and will make 1 lb. of cheese. For use with models #606, #606SS, #1606 & #1606SS.

#1377 — \$69.99



Big Bite® Dual Gear Stuffers

Cut your time in half. The sturdy frame, notched piston rod, and hard carbon steel gears are built to withstand the pressure needed to stuff even small sausages. Two speed design: high speed raises the piston quickly for filling the cylinder, low speed is for stuffing casings. Air release valve in piston ensures even pressure and better results. Stainless steel cylinder is removable. Includes four stainless steel stuffing tubes (5/8", 3/4", 1" and 1 1/2" O.D.). **25 lb. stuffer is not recommended for snack sticks. Five Year Warranty.**

C. 25 lb. Dual Gear Stuffer

#1111 — \$599.99 (add \$10.00 extra shipping)

D. 10 lb. Dual Gear Stuffer

#1112 — \$399.99 (add \$15.00 extra shipping)

#468N 1/2" O.D. stuffing tube for snack sticks

Tube for use with 10 lb. Stuffer only. \$13.99

THE ANSWER TO ONE PERSON STUFFING!

**BEST
SELLER**



Big Bite® Motorized Stuffers

These large capacity stuffers are powerful, fast and perfect for one-person operation with the included foot pedal. Durable stainless steel construction for easy cleaning. Fully adjustable speed and automatic stop makes operation a snap. Food grade plastic piston with air valve for reduced pressure. Freestanding removable cylinder stands for easy filling. Comes with four stainless steel tubes (½", ⅝", 1", 1¼"), foot pedal and handle for manual operation. **ETL Certified.**

One Year Warranty.



E. 30 lb. Motorized Stuffer

#1217 — \$859.99

F. 20 lb. Motorized Stuffer

#1219 — \$779.99



WARNING: Cancer and/or Reproductive Harm
www.p65warnings.ca.gov



Check out our product video at
LEMproducts.com



**FOOT PEDAL AND
4 STAINLESS STEEL
TUBES INCLUDED!**

REPLACEMENT TUBES FOR VERTICAL STUFFERS

Stainless Steel Tubes with 1 1/16" Base

Fits 606, 606SS, 1606,
1606SS Stuffers.

#606A ½" O.D. \$15.49

#606B ⅝" O.D. \$14.49

#606C 1" O.D. \$14.49

Stainless Steel Tubes with 2" Base

Fits 607, 607ss, 1607, 1607SS,
1217, 1219 Stuffers.

#607A 5/8" O.D. \$14.49

#607B 1" O.D. \$14.49

#607C 1¼" O.D. \$14.49



SAUSAGE CASINGS

NON-EDIBLE CASINGS

Visit our website for our complete selection of casings



More info & options at LEMproducts.com

Fibrous Casings—Non-Edible

Use for summer sausage, large bologna, and salami. Tie with string or use hog rings to close after filling. Made of paper/pulp materials with a string tied at one end. **Kosher Certified.**

Capacity (Approx. per Casing)	Description	Bundles of 25		Bundles of 100	
		SKU#	Price	SKU#	Price
3 lbs.	2½" x 20" Clear Unprinted	#124B	\$17.69	#124A	\$59.99
3 lbs.	2½" x 20" Mahogany Unprinted	#126B	\$18.99	#126A	\$66.00
3 lbs.	2½" x 20" Clear Printed	#1431B	\$16.99	N/A	N/A
3 lbs.	2½" x 20" Mahogany Printed	#128B	\$19.99	#128A	\$56.00
1 lbs.	1½" x 12" Clear Unprinted	#256B	\$12.99	#256A	\$44.00
1 lbs.	1½" x 12" Mahogany Unprinted	#130B	\$15.49	#130A	\$51.00
1 lbs.	1½" x 12" Clear printed	#1415B	\$14.49	N/A	N/A
1 lbs.	1½" x 12" Mahogany Printed	#1416B	\$12.99	N/A	N/A
5 lbs.	4" x 20" Clear Unprinted	#855	\$14.99	#855A	\$51.00



Netted Honeycomb Fibrous—Non-Edible

Beautiful casings that make a great gift. 2½" x 20". #1419B Bundle of 3—capacity approximately 3 lbs. per casing \$20.49

Old Fashion Collagen Middles—Non-Edible

They shrink with the meat! Eliminate the loose wrinkled look you get with fibrous casings when you make summer sausage, bologna, pepperoni and dry sausage. A good value. Made of beef protein. String tied.

Capacity (Approx. per Casing)	Description	Bundles of 25		Bundles of 100	
		SKU#	Price	SKU#	Price
3 lbs.	2½" x 20" Clear Printed	#761	\$12.99	#761A	\$44.00
3 lbs.	2½" x 20" Mahogany Printed	#763	\$14.49	#763A	\$50.00
3 lbs.	2½" x 20" Clear Unprinted	#1417B	\$15.49	N/A	N/A
3 lbs.	2½" x 20" Mahogany Unprinted	#1418B	\$12.99	N/A	N/A
1½ to 2 lbs.	2" x 18" Clear Unprinted	#803	\$10.99	#803A	\$37.00
1½ to 2 lbs.	2" x 18" Mahogany Unprinted	#805	\$12.99	#805A	\$44.00
12–14 oz.	2" x 12" Clear Unprinted	#904	\$9.99	#904A	\$34.00
1¾ lbs.	1¾" x 24" Clear Unprinted	#1106	\$15.99	#1106A	\$54.00



Jumbo Bologna Casings—Non-Edible

The fiber in these synthetic fibrous casings run lengthwise, so they can be stuffed tighter without breaking. Can be stuffed to 4.69" in diameter. Suitable for use in smokers. 7½" x 24". #1013 Bundle of 6—capacity approximately 7 lbs. per casing \$9.99



Hot Dog Casings—Non-Edible

25 mm. Kosher certified. #768 Capacity approx. 28 lbs. \$5.99 per pack

Collagen Rounds—Non-Edible

Use rounds to make ring bologna or any ring sausage your heart desires.

Capacity (Approx. per Casing)	Description	Bundles of 25		Bundles of 100	
		SKU#	Price	SKU#	Price
1¼ to 1½ lbs.	Collagen Rounds 43 mm (1½" x 18")	#847	\$13.99	#847A	\$48.00

Smoked Lined Casings—Non-Edible

Smoked flavor on the inside of the casings.

Capacity (Approx. per Casing)	Description	Bundles of 25	
		SKU#	Price
1½ lbs.	2" x 14" Clear Unprinted	#727	\$18.49
3½ lbs.	3" x 20" Clear Unprinted	#729	\$23.49

Cellulose Casings—Non-Edible

No prep needed. Stuff, smoke, peel and eat.

Capacity (Approx. per Casing)	Description	SKU#	Price
21 lbs.	25 mm Black Stripe	#1413	\$5.99
25 lbs.	31 mm Black Stripe	#1414	\$6.49



EDIBLE CASINGS

Collagen Casings—Edible

Easiest casing you'll ever use! Uniform in size for easier stuffing. Use for fresh or smoked sausages. No preparation required. Made of beef protein. Casings come in rolled strands of varying length for easy storage.

BUY 3 OR MORE OF ONE SKU, GET 15% OFF THAT SKU.

Size, Description	SKU#	(Approx. Stuffed Weight)	Price
17 mm, Smoked Mahogany	#817B	15 lbs.	\$11.49
19 mm, Smoked Mahogany	#247B	16 lbs.	\$11.49
19 mm, Smoked Clear	#241B	16 lbs.	\$11.49
21 mm, Smoked Clear	#136B	20 lbs.	\$13.49
21 mm, Fresh Clear	#132B	20 lbs.	\$13.49
21 mm, Smoked Mahogany	#1412B	20 lbs.	\$13.49
32 mm, Smoked Clear	#138B	21 lbs.	\$13.49
32 mm, Fresh Clear	#134B	21 lbs.	\$13.49
24 mm, Smoked Clear Hot Dog	#849	12.5 lbs.	\$7.99

ORDER MORE AND SAVE!

CAN'T DECIDE? GET A LITTLE OF EACH!

Casing Variety Pack

Having trouble selecting a casing or just want to have choices when making different kinds of sausages? The Casings Variety Pack gives you options! Includes hog casings, 32 mm fresh collagen, 19 mm smoked mahogany, collagen rounds, fibrous casings and collagen middles. Stuffs about 75 lbs. sausage. **#966 — \$26.99**



NATURAL CASINGS MAKE JUICIER, MORE TENDER SAUSAGE

They provide a distinctive "pop" when you bite into them. To use, rinse casings in warm water several times, then soak in water 30 minutes until soft and pliable. Properly salted and refrigerated, casings should last at least a year. Will vary in length.

Sorry, cannot ship to Canada.

Capacity (Approx. per pack)	Description	SKU#	Price
100–125 lbs.	32–35 mm Natural Hog Casing	#140	\$43.99
20–25 lbs.	32–35 mm Natural Hog Casing	#141	\$11.49
75–85 lbs.	40–42 mm Natural Beef Rounds	#359	\$34.99
45–50 lbs.	19–21 mm Natural Sheep Casings	#242	\$44.99
15 lbs.	19–21 mm Natural Sheep Casings	#243	\$13.99

Visit our website for our complete selection of casings



More info & options at LEMproducts.com



Sausage Pricker

An essential for sausage making! Use to remove air pockets in stuffed casings prior to cooking or smoking. **#1200 — \$12.99**

PRE-TUBED NATURAL CASINGS

No more knots or searching for the end!

Pre-tubed natural casings on "straws" make it a cinch to load the stuffing tube. Just slide the straw over the tube, hold back the casing, and pull out the straw. Will vary in length.

Sorry, cannot ship to Canada.

Capacity (Approx. per Casing)	Description	SKU#	Price
100 lbs.	Pre-Tubed Hog Casing	#1156	\$42.99
50 lbs.	Pre-Tubed Hog Casing	#1241	\$23.99
45 lbs.	Pre-Tubed Sheep Casing	#1157	\$54.99
20–25 lbs.	Pre-Tubed Sheep Casing	#1243	\$29.99

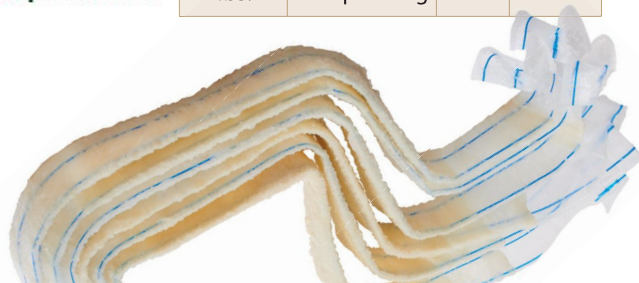

THE PERFECT STUFFING KIT TO GET YOU STARTED!

A. SAUSAGE STUFFING KIT

This kit includes our famous 5 lb. Vertical Stuffer, all the casings and seasonings you could want and a step-by-step "how-to" book. Get started today and Save!

#838 — \$219.99



EVERYTHING YOU NEED TO MAKE SAUSAGE AT HOME!

STUFFING KIT INCLUDES:

- 5 lb. Stainless Steel Stuffer with Plastic Tubes
- Home Sausage Making Book
- Backwoods Fresh Variety Pack, makes 5 lbs. each of Breakfast, Hot Breakfast, Sweet Italian & Hot Italian Sausage
- Backwoods Fresh Bratwurst Seasoning, makes 5 lbs.
- Backwoods Summer Sausage Seasoning, makes 5 lbs.
- 5 – 1 1/2" x 12" Clear Fibrous Casings
- 1 – Pack 32 mm Fresh Collagen Casings

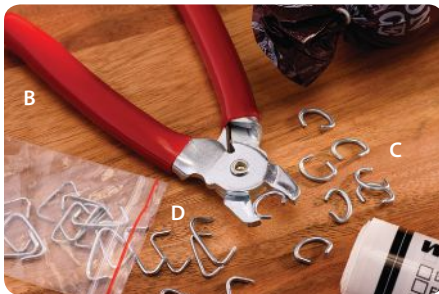

Hog Ring Pliers & Rings

Dipped rubber handles and solid construction allow tighter crimping with less stress on the hand.

B. Manual Pliers

Now with spring action opening.

#024 — \$14.99

C. 3/8" Rings (100 ct.)

#025 — \$4.29

D. 1/2" Rings (100 ct.)

#025A — \$4.29

B & C. Pliers & 3/8" Ring Kit (100 rings)

#026 — \$18.99

B & D. Pliers & 1/2" Ring Kit (100 rings)

#026A — \$18.99



Spring Loaded Pliers & Hog Rings

Pliers crimp rings to smaller diameter!

Commercial quality with ergonomically designed soft rubber handles. Heavy construction ensures years of use.

E. Spring Loaded Pliers & Hog Rings (100 ct.)

#816 — \$42.99

F. Hog Rings for Spring Loaded Pliers (500 ct.)

#816A — \$10.99

E & F. Spring Loaded Pliers & Hog Rings (600 ct.)

#816B — \$49.99



Cotton Twine

Use to tie casings or roasts before smoking and grilling.

G. 2 lb. Cone

1500' #355 — \$8.99

H. 1/2 lb. Ball

375' #028A — \$4.49

Sausage Linker

Make uniform sausage links in no time with this manual sausage linker! Simply insert your sausage into the linker, set your desired length (from 1" to 7" long) and turn the handle. Accepts up to 32 mm diameter natural or collagen sausage casings. Stainless steel construction for easy clean-up. Spool of string included.

#1216 — \$479.99

#03162001 100m string \$2.99





BIG BITE MEAT SLICERS

Commercial quality and high-end performance you will appreciate. Our 8.5" and 10" Semi-Automatic Slicers deliver the commercial-grade performance you expect. A powerful induction motor and reliable belt drive create plenty of torque for a large variety of meats, cheeses and breads. The large capacity tilted food carriage glides effortlessly across the stainless steel blade for deli quality cuts 1 mm–10 mm thick. A solid metal food pusher with teeth allows for precise control while keeping fingers safe. A graduated knob allows for customized thickness. The unit has a built-in sharpener that keeps the blade sharp. Sturdy cast aluminum housing and skid-resistant feet add to stability. **ETL Certified. Five Year Warranty.**

8½" Blade

#1185 — \$369.99 (add \$6.00 extra shipping)

10" Blade

Replacement Belt and Replacement Blade Sharpening Stone Included.

#1020 — \$429.99 (add \$7.00 extra shipping)



More info & options at
LEMproducts.com



7½" Belt Driven Meat Slicer

This 150 watt belt-driven slicer will cut cleanly through cheese, meats, and even partially frozen food. Cuts up to .8" thick. Serrated stainless steel 7 ½" blade spins at 90–110 RPM. Large 7 ¼" x 6 ¼" carriage tray. **ETL Certified.**

#1381 — \$99.99

NEW! 8½" Slicer

This 8 ½" meat slicer includes a handy built-in tray to catch sliced meats and two blades. Use the standard blade for deli thin cuts or the serrated blade for crusty breads or fibrous foods. The sturdy die cast aluminum base and suction cup feet make this reliable slicer easy to use. Removable hand guard/food pusher to keeps fingers safe. Carriage removes easily making clean up a snap. Includes: pulse function & 2 blades. Cutting thickness up to ¾". **ETL Certified.**

#1511 — \$139.99 (Available after 10.1.19)

Mighty Bite 8½" Belt Driven Slicer

Easily swap in the serrated blade to slice fibrous meats or cheeses. Quiet, belt-driven blade to stand up to even the toughest tests. The large blade allows you to slice taller cuts of meat deli thin. Sturdy aluminum frame with suction feet for added stability. Easily disassembles for clean-up. Clear plastic, removable hand guard. (Two blades included). **ETL Certified. Two Year Warranty.**

#1240 — \$209.99



A. 330 lb. Stainless Steel Digital Scale

Finally, a compact stainless steel scale to weigh all of your needs! Perfect for the big jobs or simple everyday use. Large food grade stainless steel surface. LED large digital display is easy to read. One touch tare function zeros out container weight. Automatic shutoff preserves battery life. Includes one 9 V battery and optional AC adapter. Weigh as little as 50g/11 lb./1.8 oz. **CE certified.**
#1167 10½" x 10½" — \$72.99



B. Freezer Tape

Acrylic adhesive on this high quality freezer tape holds tight in freezer temperatures. 60 yards per roll. ¾" width. **#033 — \$2.79 each 5 OR MORE \$2.29 EACH**

C. Tape Dispenser

Accepts tape up to 1" wide with 1" or 3" core. Heavy duty, heavy weight, rubber bottom is skid proof and tip-resistant. Includes one roll of tape.
#034 — \$11.99

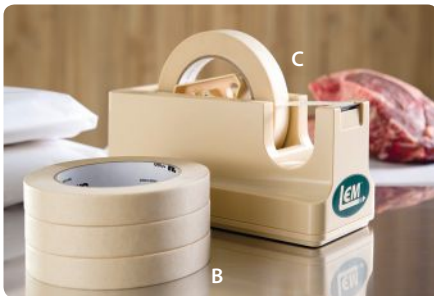

D. CUSTOMER FAVORITE! LEM Freezer Sheets

Don't let your freezer meat get you stuck!
 USDA approved Freezer Sheets prevent patties from sticking together so burgers easily separate when removed from freezer. 1,000 sheets per box.
#027A 6" x 10¾" sheets \$13.99

E. 11 lb. Digital Kitchen Scale

This 11 lb. Digital Kitchen Scale is an absolute necessity! Accurately weigh special ingredients for recipes or food portions for special diets. Easy to clean sleek glass top. The easy-to-read digital scale measures up to 11.3 pounds/5 kilogram by 0.1 oz./1 gram increments. Zero adjusting tare function. 2 AAA batteries included.
#1193A — \$25.79



F. 44 lb. Stainless Steel Scale

This scale has a large 8" dial and weighs pounds in 2 oz. increments or kilograms in 50 g increments. Sturdy stainless steel base supports a large 9½" x 9½" stainless steel platform.
#435 — \$61.99

G. Poly-Coated Freezer Paper

Premium 40 lb. paper minimizes freezer burn.
 Always use freezer paper for maximum protection. 1100 ft. roll should wrap 15–20 deer. 450 ft. roll should wrap seven–nine deer. Color: White.

CUSTOMER FAVORITE!

18" paper for larger animals

#031 1100 ft. \$67.99 (\$5 extra shipping per roll)

15" paper ideal for smaller animals

(\$5 extra shipping per roll)

#030 1100 ft. \$64.99

#030A 450 ft. \$39.99

H. Paper Cutters

All steel with grey finish—use on countertop or mount under counter or on wall (mounting hardware not included).

#035 18" wide \$47.99

#035A 15" wide \$41.99





Economy Meat Lug

Poly meat lug, 21¼" x 15¾" x 5". FDA Approved. Holds up to 50 lbs. White. Lid or cover sold separately. MADE IN USA. **NSF Certified.**

#663 Lug \$13.49 **2 FOR \$22.50**



General Duty Meat Lug

Made of FDA approved high density plastic. Great for mixing sausage. 21¼" x 15¾" x 7". Holds up to 50 lbs. Grey. Lid sold separately. MADE IN USA. **NSF Certified.**

#045 — \$14.99



BEST SELLER!
Heavy Duty Meat Lug

Smooth interior for easy clean-up. Reinforced handles. Ribs on top and bottom add extra strength for extended life. Holds up to 50 lbs. 21¼" x 15½" x 7". White. Lid sold separately. MADE IN USA. **NSF Certified.**

#360 — \$16.99



ADD A LUG COVER OR LID

Meat Lug Cover

Will fit all LEM lugs. Use for stacking. Does not snap on. Not air tight. White. MADE IN USA.

#360A — \$10.99



Meat Lug Snap-On Lid

Sanitary Food Storage Solutions! Snap-on stackable lid. Raised lid provides increased capacity. Dishwasher and freezer safe.

22½" x 15½" x 2½". White. MADE IN USA.

NSF Certified. Will fit all LEM lugs.

#1173 — \$17.49



Plastic Drain Tray

Durable poly tray covers base of lug and hold food above bottom for draining. **Will fit all LEM lugs.** Finger holes for easy removal. 17¾" x 12¾" x ¾".

#1198 — \$11.99



BEST SELLER!
Drain Lug

Perforated drain lug for cleaning, thawing or keeping prepared food iced. Impact resistant made of high density polyethylene. Dishwasher and freezer safe. 20" x 15" x 5". White. **Will fit all LEM lugs.**

MADE IN USA.

#1181 — \$24.99



STAFF RECOMMENDED!
Meat Lug Liners

Make clean-up a breeze with these liners. Easily disposable after use. 22 ¾" L x 17" W x 20" H. **Will fit all LEM lugs.**

#1293 25 ct. — \$12.99





MAKE THE MOST OF YOUR MOST GRINDER

Grinder attachments you won't want to miss! Your Big Bite® Grinder is capable of much more than just grinding. With the addition of attachments, your grinder can go from grinding meat to making patties, jerky and even juice!



MIX YOUR MEAT

Our 25 lb. and 50 lb. manual mixers attach to the shaft of our Big Bite® grinder motor making a tough job easier. Removable paddles for easy cleaning. Tilt model rotates for easy removal of meat. See Page 10 for details about our full line of meat mixers.



MAKE PATTIES

Hands-free patty making right from your grinder. You can grind meat and form patties at the same time. Add seasoning to mix flavor into every patty. See page 09 for details.



MAKE JUICE

This customer favorite converts tomatoes, grapes and a variety of other fruits and vegetables into delicious purees, sauces, and juices in seconds. See page 08 for details.





NEW! DUAL GRIND ATTACHMENT

Our newest addition to the Big Bite® family will save you time by delivering two grinds in a single pass.

See page 08 for details



MAKE PATTIES, JERKY OR SNACK STICKS

Attach to the head of your grinder, and select the plate (burger, jerky, snack stick) and stand back as your grinder does the rest. Wax paper (included) carries your meat down chute. Great for bulk packaging.

See page 09 for details.



SLICE OR TENDERIZE CUTS OF MEAT

Make perfect cuts of jerky and tenderize the toughest cuts of venison, beef or other meat. Our sturdy cast aluminum attachment includes 2 sets of rollers, one set for slicing and one for tenderizing.

See page 09 for details.



TIPS FROM TY

For over 15 years I've been on the frontlines with our customers. And I love it! It's where I get my inspiration. I learn about what folks like and what they don't; what works and what doesn't. Then I make it my mission to build just the right product or find just the right solution. And when I do it's a great feeling. Here are just a few tips I've learned along the way.

– Ty Zeinner, LEM Product Manager

GRINDER TIP

Clean up is always an issue. When grinding is complete run some crushed ice or stale bread through the grinder. Not only will this help with clean up it will push that last bit of meat out of the grinder head. No waste!

SAUSAGE MAKING TIP

When making sausage links, instead of twisting every link, twist the first link, skip the next one and twist the third link the same direction as you did the first link. Save time!

ENERGY SAVING TIP

When your freezer inventory is running low, save on energy cost by filling the freezer with ice packs or water filled jugs. A full freezer costs less to run, and the ice will come in handy to cool your harvest in the upcoming season.

FILL YOUR FREEZER

CUSTOMER FAVORITE! Ground Meat Bags

Pack your ground meat the easy way. Quality opaque, polyethylene bags have a 1½" bottom gusset for added burst protection. The heavy 2 mil thickness guards against freezer burn. When filled and frozen, they stack neatly in the freezer. Seal bags using bag taping machine or hog rings. (see page 20 for Hog Rings and Pliers)

	1 lb. Size SKU#	2 lb. Size SKU#	100 Bags	1000 Bags
Pork Sausage	#036	#036A	\$12.99	\$59.99
Wild Game	#040	#041	\$12.99	\$59.99
Ground Beef	#038	#039	\$12.99	\$59.99
Plain White	#793	#794	\$12.49	\$54.99

More info & options at
LEMproducts.com



2" Stainless Steel Tubes

Fill poly bags with ground meat or sausage straight from your grinder with these wide-diameter tubes. Stainless steel tubes are long-lasting and dishwasher-safe. Length 6".



Grinder Size	Stainless Steel Tubes	
	SKU #	Price
#8	#609SS	\$30.99
#10/12	#084SS	\$30.99
#20/22	#085SS	\$30.99
#32	#086SS	\$30.99

More info & options at
LEMproducts.com



Poly Bag Tape Machine

The twist and seal solution for sealing poly bags. No more fumbling with strips of tape!
#043 Machine w/ one Roll of Tape **\$23.99**
#1242 Tape Only—¾" x 144 yds. **\$4.49**

PACKED AND ORGANIZED



STEP 1
Put a 2" stuffing tube over the plate of your grinder for the second grind.



STEP 2
Slide bag on tube and grind meat directly into bag.



STEP 3
Squeeze air out, twist bag and seal with taping machine.

Ground Meat Packaging System With 2" Stuffing Tube

Everything you need to package your ground meat in half the time it takes to freezer wrap it. Save when you buy these must-have items as a kit. Kit includes a bag taping machine, one roll of poly tape, and 50 one-pound wild game bags.

Grinder Size	Aluminum Stuffing Tube		Stainless Steel Stuffing Tube	
	SKU #	Price	SKU #	Price
#8	#200D	\$44.99	#200DSS	\$54.99
#10/12	#200A	\$44.99	#200ASS	\$54.99
#20/22	#200B	\$44.99	#200BSS	\$54.99
#32	#200C	\$44.99	#200CSS	\$54.99
(No Tube)	#200	\$30.99	N/A	N/A



TENDERIZE YOUR MEAT



F. Clamp-On Meat Tenderizer

A Best Seller at a Great Price! Clamp-On unit attaches to your table or countertop. Two cast iron rollers are full of tenderizing points to make tender cuts of the toughest meat. Plastic cover protects from moving parts. Top opening is 4" wide. Accepts meat up to 1/2" thick. #656 — \$62.99

Triple Row Tenderizer

Tired of tough cuts? This tenderizer will assure you of tender portions. Forty-eight stainless saber blades, in three rows. Dishwasher safe.

#1263 — \$19.99

Round Meat Tenderizer

Hand held meat tenderizer with 24 stainless steel points. Ideal to use on meat, fish, poultry and game before marinating. Dishwasher safe.

#608 — \$13.49



NEW! 2-in-1 Jerky Slicer and Tenderizer

Slice and tenderize meat up to 1 1/4" thick by 4 3/4" wide. Tenderize the toughest cuts or slice 12 strips of jerky in one pass. This manual cast aluminum tenderizer features 2 sets of rollers that include 22 stainless steel blades. One set of rollers is for slicing and the other for tenderizing. Perfect for beef, pork, chicken, venison, elk and all other game meats. Easily disassembles for quick cleaning. Comes mounted to a sanitary polypropylene board and 2 clamps are included to ensure stability when cranking. **One Year Warranty.**

#1432 — \$209.99



Motor Included

2-in-1 Jerky Slicer/Tenderizer with Motor

Slice meat up to 1 1/4" thick for 14 perfect jerky strips sliced and ready for the oven or dehydrator in seconds. Remove the easy off top; replace the slicer shaft with the tenderizer shaft and tenderize even the toughest cuts of meat. Easily disassembles for clean up. 2-in-1 attachment is made of durable powder painted aluminum. No tools or assembly required. Chute dimensions 1 1/4" L x 4 1/2" W x 8" H. No maintenance motor is self-lubricating.

ETL Certified. Two Year Warranty.

#602TJ — \$499.99 (add \$5.00 extra shipping)

WARNING: Cancer and/or Reproductive Harm
www.p65warnings.ca.gov



FOOD FOR THOUGHT

SKU#	Product	Description	Price
202	Canning, Freezing, Curing & Smoking Meat, Fish & Game	Various methods of preserving meats at home.	\$16.95
203	Home Sausage Making	A complete guide for the home sausage maker.	\$24.95
254	Build A Smokehouse	Directions to build four different smokers & basics of smoking.	\$3.95
317	The Sausage-Making Cookbook	Over 230 recipes for sausage & jerky. Hardcover.	\$21.95
318	Home Book of Smoke Cooking Meat, Fish & Game	An excellent choice for someone learning the art of smoking.	\$16.95
422	Basic Butchering of Livestock & Game	Covers butchering of beef, hogs, veal, lamb, deer, poultry, rabbits, & small game.	\$16.95
526	The Smoked Foods Cookbook	Contains brine recipes, brine times, smoking time, tables, & recipes. Hardcover.	\$24.95
571	Preserving the Harvest	A real encyclopedia about preserving fresh food.	\$18.95
572	Cold-Smoking & Salt-Curing Meat, Fish, and Game	Takes a head on look at traditional curing & smoking methods.	\$14.95
573	Jerky	Shows you how to make jerky using beef, venison, fish, or fowl.	\$14.95
574	Sausage	Sausage making from start to finished product.	\$16.95
905	The Backyard Homestead	Tips to preserving your fruits & vegetables as well as raise your own chickens.	\$18.95
1006	The Complete Venison Cookbook	Loaded with traditional & not-so-traditional venison recipes.	\$19.95
1062	The Complete Jerky Book	Includes everything from the history of jerky to complete instructions & recipes for preparing jerky.	\$12.95
1066	The Beginners Guide to Hunting Deer for Food	Explains the benefits of hunting deer for food & helps you get started.	\$16.95
1074	The Complete Guide to Sausage Making	A guide to making sausages using wild game & store-bought meats.	\$14.95
1100	Hot Sauce	Reveals all you need to know about making hot sauces including warnings & advice on how to use them.	\$14.95
1159	The Put 'em Up! Preserving Answer Book	399 solutions to all your preserving questions.	\$16.95
1163	The Beginner's Guide to Making and Using Dried Foods	Preserve fruits, veggies, herbs, & meat with a dehydrator, a kitchen oven, or the sun.	\$24.95
1205	Making Cheese, Butter & Yogurt	The latest, most healthful methods for whipping up delicious dairy products in your own kitchen.	\$3.95
1222	Product Guide for Processing Deer	A must-have resource for the hunter on the go with pictures.	\$9.99

ESSENTIAL FIELD TOOLS



HUNTER TESTED AND APPROVED

A. The LEM Skinner Knife

Designed by a hunter, for hunters! Focusing on comfort, balance, curve of the blade and ease of use, the 3" stainless steel blade feels like part of your hand. The polypropylene handle is easy to clean and the chartreuse color makes it tough to lose in the field. Features a Cordura sheath with belt clip.

#575 — \$20.99

B. The Field Dresser Knife

Made specifically for hunting, it has a non-slip, hunter orange handle, razor sharp gut hook, and rounded tip that won't puncture internal organs. Cordura sheath protects you from the sharp edge as well as hides the orange handle while hunting. Heavy metal clip keeps it secure on your belt. Stainless steel blade measures 5 1/8" L x 1 1/16" W. Money back guarantee!

#615 — \$35.99



C. 330 lb. Digital Hanging Scale

Compact, accurate and easy to read... and unlike spring-loaded scales, there are no coils to break. Weighs any game animal up to 330 lbs. yet stores easily in the corner of your gear bag. Can also be used to calculate tare weight. Displays weight in pounds or kilograms. Includes batteries.

#1018 — \$56.99

 WARNING: Cancer and/or Reproductive Harm
www.p65warnings.ca.gov



D. Rope Hoist & Collapsible Gambrel

This weight reducing pulley system allows for single person lifting ability. Self-locking device collapses easily to fit into your hunting bag. Comes with a 22" lightweight gambrel and tangle-free rope. System holds 500 lbs.

#338 — \$29.99

Gambrel

24" wide. Made of 3/8" dia. steel. Holds 500 lbs. **Item not pictured.**

#012 — \$13.49

E. White Bib Aprons

This is the old school butcher's apron. Heavy weight, poly/cotton apron that has a sewn-on neck strap and ties.

#336 Plain White Apron \$9.49

#1138 'Share Your Sausage' Apron \$13.39*

#1139 'Safe Stuffing' Apron \$13.39*

#1140 'Hunt the Rut' Apron \$13.39*

*THREE OR MORE \$10.39 EACH

F. Heavy Duty Vinyl Apron

Take the professional approach! The durable, waterproof material protects your clothing while butchering, making sausage, or throughout any project in the workshop. The easy-to-snap buckle and wide waist ties make this a friendly companion that will be around to help you for years!

#431 — \$24.49

E



F



G

G. Latex Gloves

Fits either hand and are powdered. 100 Gloves.

#079A Medium \$9.49

#081A Large \$10.49

#084A Extra Large \$10.49

White Knit Gloves

High quality poly/cotton blend, reversible and washable. One size fits all. **Item not pictured.**

#078 6 pair \$5.99 12 PAIR \$9.99

H. Cut Resistant Glove

Avoid nicks and cuts with a glove designed to protect your hand whenever you use a sharp instrument. Glove fits either hand.

#1478 Large \$5.99



H

I. Cutting Boards

High density polyethylene, USDA and FDA approved. Will not chip, crack or warp. Nonporous. **NSF Certified.** Available in three sizes.

#644 12" L x 18" W x 1/2" H — \$15.49

#044C 18" L x 24" W x 1/2" H — \$39.99

(add \$4.00 extra shipping)

#044A 24" L x 36" W x 1/2" H — \$82.49

(add \$5.00 extra shipping)



I



More info & options at
LEMproducts.com

ROOTS

& HARVEST



by **LEM**



More info & options at
RootsandHarvest.com



Stainless Steel Vegetable/Fruit Slicer

Versatility at its finest! Constructed of quality stainless steel, this durable slicer can create fruit and vegetable slices from paper thin up to $\frac{3}{8}$ " thick. Legs fold up for easy storage and it's top-rack dishwasher safe. Includes five interchangeable blades; three Julienne Blades, Slicing Blade & Waffle Blade. Plastic food pusher included.

#829 — \$69.99

FIVE INTERCHANGEABLE BLADES!



Pineapple Slicer

Peels, cores, and slices fresh pineapple in just 30 seconds. Shell remains intact and the fruit retains its juice, making clean-up a breeze. Quick release grip for easy storage. Made of stainless steel.

#1454 — \$12.99



Deluxe Bean Frencher

Turn out delicious, slender french-cut slices. Feed your fresh green beans into the hopper and crank away. The heavy-duty Bean Frencher conveniently clamps to any surface up to $1\frac{1}{4}$ " in thickness, and features durable stainless steel cutting blades.

#914 — \$27.99



Corn Cutter/Creamer

Here's a simple yet efficient tool to remove corn from the cob in just a few swipes. Great for making cream style corn. Stainless steel blade yields perfect whole kernels when the shredder is removed and scraper is lowered. Measures 17" long.

#913 — \$13.49



Apple/Potato Peeler

Peel, core and slice an apple or potato all in one easy motion. Peel only or slice and core... the option is yours! Makes great curly fries. The suction base attaches to any smooth, flat surface.

#662 — \$25.99



Manual Food Strainer

Great for tomatoes! Separates seeds and peelings from the meat and juice of fruits and vegetables. Make sauces, pie fillings, homemade ketchup and much more. Clamp-on base will fit most counter tops. Large capacity hopper, easy turn handle and one stainless steel apple & tomato screen. **#806 — \$59.99**

#810 Grape Screen — \$12.99 #811 Berry Screen — \$13.99 #812 Salsa Screen — \$13.99

A. Stainless Steel Compost Keeper

Attractive and odor-free! Fluted stainless steel design looks great in any kitchen. Holds up to one gallon of waste. Dual carbon filters and aeration holes effectively eliminate unpleasant odors. Carbon filters last up to six months. Dishwasher safe. Measures 11" H x 7" Dia.

#9075S Compost Pail \$47.19
#1099 Replacement Filters \$6.19

B. Compost Keeper Bags

Use these bags to make the job easy and keep your compost pail clean. Meets compost standards. 50 6-liter bags, 14" x 16" to fit most keepers and pails. **#1165 — \$10.29**



Stainless Steel Food Mill

Make homemade mashed potatoes, sauces, and baby food from this multipurpose mill. Side clip allows this unit to nest into household pots. The 2-quart container comes apart for easy cleaning.

#1126 — \$29.99



NEW! Stainless Steel Fruit Crusher

This stainless-steel fruit crusher is essential for crushing bushels of apples, pears & other hard fruits before pressing in the Roots & Harvest Fruit and Wine Press. Effortlessly crush and produce the perfect pulp by cranking the handle. The extra-large, attached hopper and waste slider are exclusive to Roots and Harvest Crusher. Made of 304 stainless steel construction for a lifetime of use. 8.75" L x 12.5" W x 17" H.

#955 — \$239.99 Additional \$5.00 shipping

Walnut Cracker

Cracks black walnuts with ease! This heavy duty aluminum tool can handle any nut. Adjustable design allows for most sizes. The powerful gear lever action opens hickory nuts, pecans and black walnuts in a fraction of the time it takes with other crackers. This simple device makes a nut lover's life easier.

#1012 Comes Assembled — \$64.99



C. Long handled Wooden Spoon

This beechwood, extra-long-handled, spoon is excellent for stirring jams or jellies in your largest stockpot. The long handle eliminates the possibility of the spoon falling into the pot. The handle stays cool to the touch and won't scratch non-stick pans. Great to use with acidic foods because wood is naturally non-reactive and won't leave a metallic taste or change the color of the food you are cooking. 18" long.

#1346 — \$2.99

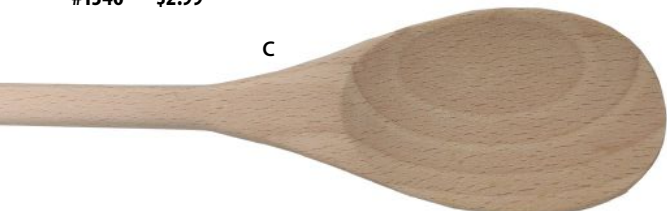

D. Bamboo Cabbage Stomper

Massage cabbage for kraut with this bamboo stomper. Or use stomper to tightly pack vegetables in your fermenting vessel and remove air pockets. Double-sided design will fit perfectly in most jars or crocks. 13" long, 2.5" at one end, 2" at the other. (Note: Not intended to be used with meat grinders).

#1315 — \$19.99



Fat Skimming Ladle

Easily separate fat from broth with this uniquely designed ladle. Simply tip the ladle backwards and let the broth pour back into the stock pot while fat remains in the ladle for easy removal. Hanging hook for convenient storage also keeps the ladle from falling into stockpot. Stainless steel. Dishwasher safe. #1231 — \$17.49

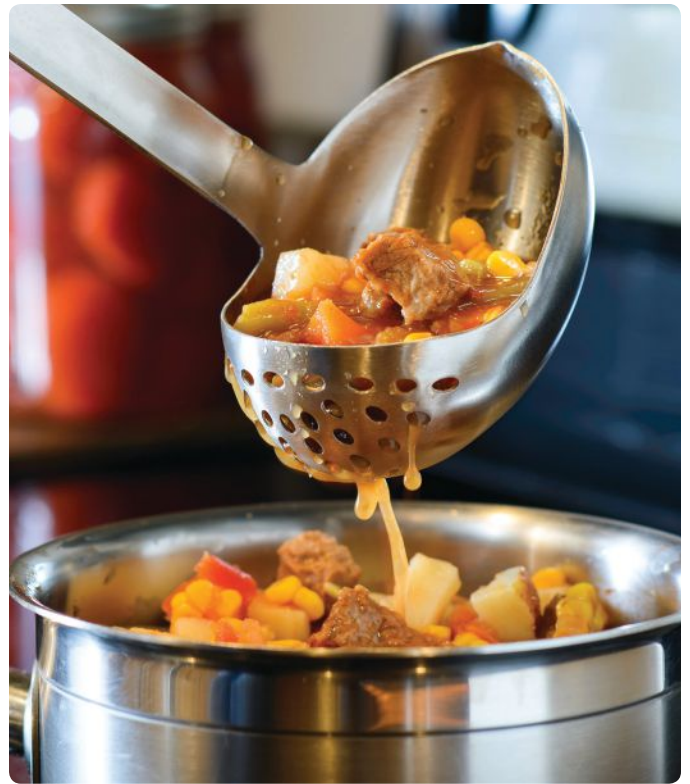

Staff Favorite! Straining Ladle

Now in 2 sizes! Our Straining Ladle lets you scoop, pour and strain all with one tool. Features perforated holes to strain liquids while the solid side allows scooping and pouring. Stainless steel.

#1455 3 oz. \$14.99

#912 6.5 oz. \$17.99



Cabbage Cutter

This Cabbage Cutter is made of sturdy, hand sanded, beechwood. The three fine, super-sharp, stainless steel blades deliver a smooth cutting action which will shred whole heads of cabbage in just minutes. Includes sliding box with food pusher for safe and easy operation. 23" x 9". Slices 1/8" thick

#1347 — \$39.99

Skimming Ladle

The large capacity stainless steel skimming ladle is perfect for skimming fats and froth off of soups and stews and straining veggies and pasta or straining cheese curds from whey. Shaped handle for easy grip. Dishwasher safe. 14 1/2" long.

#1183 — \$10.29

JarBox

Frustrated by boxes that get wet and tear?

Annoyed when jars get dusty or break? Are you living in an earthquake zone? Cradle your preserving jars in JarBox, a pair of rigid plastic shells that snap shut to keep a dozen canning jars safe, clean, and organized. Protective, stackable, storable, transportable, versatile—and ingenious. Developed in America and made in Canada with recycled content.

#1160 Pint \$13.49

#1161 Quart \$17.49

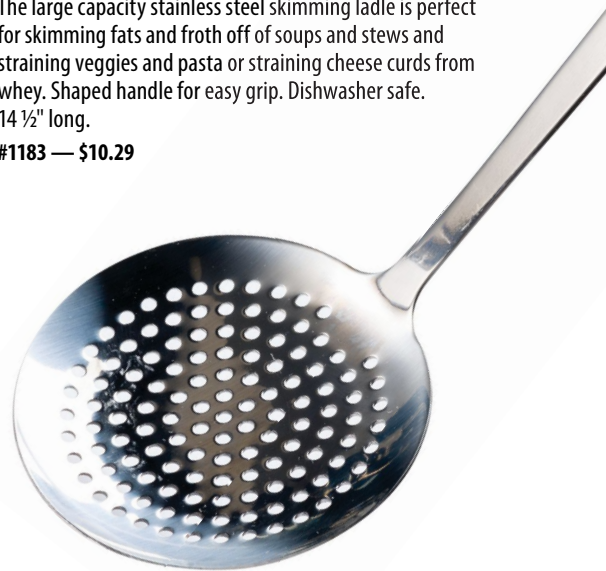

HOMESTEADING ESSENTIALS



Cheese Press

Designed for making small batches of cheese at home. Features all metal construction, stainless steel cylinder and all metal gears. This press will hold up to 2 gallons of milk and produce a 1-2 lb. wheel of cheese. Simply crank the handle to press out the whey and form a perfect wheel of cheese. Making your own cheese at home has never been easier.

#1426 — \$139.99

Cheese Wire

Easily cuts through all types of firm cheeses to a desired thickness. Stainless steel 11" wire. Sturdy, durable, and resists rust.

#1448 — \$4.99



Water-Seal Crock Sets

Create delicious sauerkraut, pickles, and more with these ceramic, water-seal crock sets. These sets are easy to use and come complete with lid and weights. Built-in handles make them easy to carry and move. Select the right size for you and start fermenting.

#1294 5L (approx 1 1/3 gallons.) \$54.99

#1295 10L (approx 2 3/5 gallons.) \$64.99

#1296 15L (approx 4 gallons.) \$84.99

Sterilizing Rack

No more magnet wands and burnt hands! Holds up to 12 regular or wide mouth canning lids. Water circulates freely around the lids to sterilize them completely. Extended arm provides easy handling for removing lids from boiling water. Dishwasher safe.

#921 — \$15.99

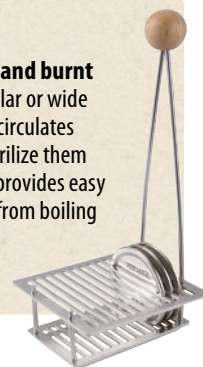

Ultimate Canning Kit

Ready to start canning a full bounty of fruits, vegetables and even meats? Includes: 16 qt. Pressure Canner, 6-piece Canning Kit (funnel, jar lifter, kitchen tongs, jar wrench, bubble popper/measurer and magnetic lid lifter), Lid Sterilizer, 1 cup Ladle and Beginner's Guide to Preserving Food at Home book.

#1117 16 qt. \$174.99 **SAVE \$14.42**

Presto® Ultimate Pressure Cooker/Canner

#957 16 qt. \$123.99

#958 23 qt. \$144.99

#959 Replacement Seal \$10.99

SAVE TIME WITH THESE TOOLS

Commercial French Fry Cutter

Crank out the best tasting french fries (or sweet potato fries) you ever tasted! This reliable, heavy duty all metal cutter turns out uniform fries, zucchini sticks and other favorites with one push of the handle. Includes suction feet for use on smooth countertops or can be permanently mounted on countertop or wall. Includes two cutting plates ($\frac{3}{8}$ " & $\frac{1}{2}$ ") for making thin cut or regular fries.

#825 — \$121.99

French Fry Cutter Accessory Plates

Now you can easily make wedge and shoestring french fries! Set of two.

#825PK — \$40.99

"Wow! Makes cutting potatoes to fries effortless. Suction feet prevent slipping too. And I thought small cutters worked well..." — Doug F.

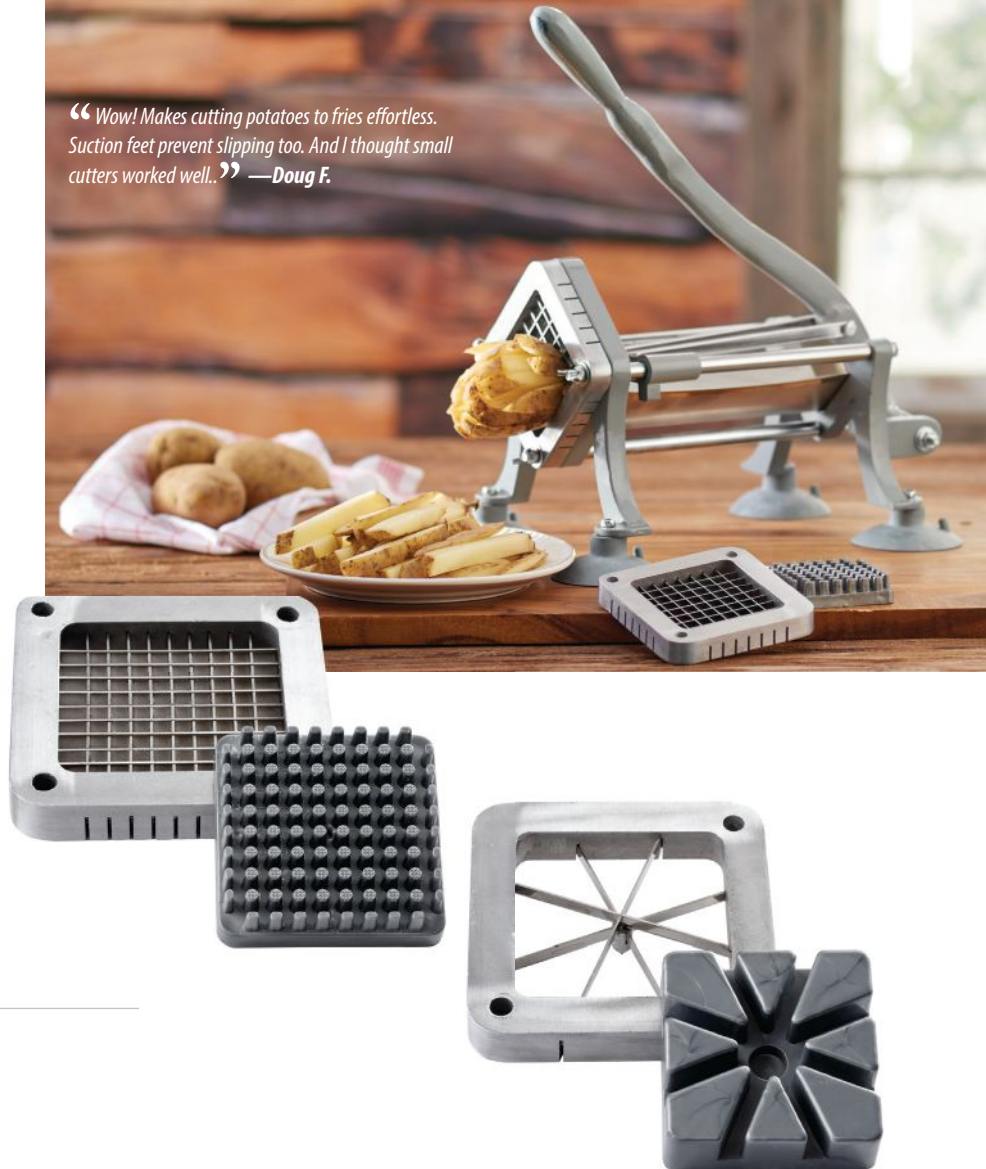

EASY TO MAKE FRIES



French Fry Cutter

Make mountains of french fries in minutes. Two stainless steel cutting plates for regular or thin fries. The suction base attaches to any smooth flat surface. For best results halve potatoes prior to cutting. Do not use with sweet potatoes.

#587 — \$26.99

Replacement Blades and Pushers

#11120003 36 hole $\frac{1}{2}$ " coarse blade and push plate \$4.98

#11120001 64 hole $\frac{3}{8}$ " fine blade and push plate \$4.98



Butter Churner

Make your own homemade butter. Screw on top fits standard large mouth mason jars. All metal gears and stainless steel paddles. Enjoy fresh butter in as little as 10 minutes. Includes: jar, paddle mechanism, step by step instructions and a selection of recipes.

#1226 — \$44.49



Briner Buckets

The easiest way to brine hams, bacon or turkey! The patented design includes a unique locking plate insert that keeps food submerged for a more effective brining process. Includes lid and pressing plate in each bucket.

#1234 8 qt. holds up to one whole chicken or 10 lb. pork shoulder, 10¾" H x 8¾" dia. **\$20.99**

#1235 22 qt. holds a 25 lb. turkey; four chickens; several racks of ribs, 15¾" H x 12" dia. **\$30.99**

Poly Ham Nets

Use for smoking hams, shoulders and turkeys. 33" long, poly nets.

Item not pictured. #634 10 Count \$5.29

Stockinettes

50% poly/cotton blend. Tight weave holds juices in meat. 32" long.

Item not pictured. #750 10 Count \$4.69

Venison Bacon Seasoning

Turn ground venison into bacon.

#9137 makes 25 lbs. \$8.49

Bacon Cures

Making bacon couldn't be easier with a bag of LEM Bacon Cure. Rub it on or mix up a brine. Give it some time and smoke! Our cures work on all types of meat. Enough to cure 25 lbs.

#9122 Original Dry Rub **\$8.49**

#9133 Original Smoked Brine **\$8.49**

#9134 Maple **\$10.49***

#9135 Cracked Pepper **\$10.49***

#9136 Jalapeño **\$13.49***

* Can be used as a dry rub or brine



Ham Curing Kits

Includes: ham curing seasoning, two nets for hanging, and complete curing and general smoking directions. Kit will cure 20 lbs. of meat.

#9370 Sweeter Than Sweet **\$10.49**

#9371 Brown Sugar **\$10.49**



EASILY HANG YOUR BACON

Bacon Hanger

This 10 pronged stainless steel hanger is perfect for hanging pork bellies in your smoker. Can also be used to hang spare ribs, jerky, even brisket. Sharp points pierce meat easily. Hang hook fixture is offset to avoid tipping when loaded.



#1134 11 ¼" x 6 ¾" \$11.99

CUSTOMER FAVORITE! Morton® Tender Quick

A fast cure product for use on meats, game, poultry, salmon, and other fish. Can be used as a dry cure or a pickling cure.

#159 2 lb. bag \$7.49



DIGITAL THERMOMETERS TAKE THE GUESS WORK OUT OF COOKING



Food Thermometer with Stand, Alarm & Timer

Great for smokehouse sausage making. The 42" long heat resistant cord allows the smokehouse door to close while the probe measures the internal temperature of the meat. Alarm sounds when preset internal temperature is reached.

Keep probe wire away from open flame.

#1423 — \$23.99

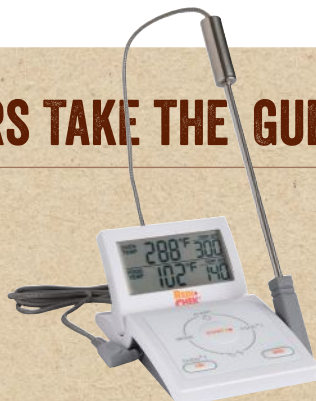

Dual Sensor Food Thermometer & Timer

Monitor food and oven temps at the same time! Preset the desired internal temperature and the alarm sounds when temp is reached. Probe wire is 45" long. Probe stores in holder on side. Includes digital dual screen monitor. **Keep probe wire away from open flame.**

#678 — \$38.49



Redi Chek® Remote Food Thermometer with Timer & Alarm

Monitors cooking up to 100 feet away. When the preset temperature in the meat is reached, an alarm will sound on your monitor. Customize the settings for rare, medium and well done. **Keep probe wire away from open flame.**

#601 — \$51.99

SKU#	Battery Included	Range (F)	Preset Temp Function	Length of Probe Cord	Remote Function	Max. Time	Reads Both Oven Temp & Food Temp	Program for Meat Type or Degree of Doneness	Use as Timer Only
#1423	Yes	32°–572°F	Yes	42"	No	99 hr.	No	Yes	Yes
#678	Yes	32°–572°F	Yes	45"	No	10 hr.	Yes	Meat Temp Only	Yes
#601	Yes	14°–410°F	Yes	42"	Yes	24 hr.	No	Yes	Yes

SILVERSKIN KNIFE KIT



NEW! SilverSkin Knife Kit

Effortlessly trim away silver skin for the best cuts! Silver skin is a thin membrane of tissue often found on venison or other game. It does not allow spices/marinades to permeate and unlike fat it will not melt away when cooked. If not removed it may leave meat gristly and gamey. The LEM SilverSkin Knife Kit includes safety glove, two blades, and purpose designed pliers to help you safely trim away silver skin so you can “eat better meat”. **One Year Warranty. ETL Certified.**

#1475 Kit — \$79.99 #1477 Meat Gripping Pliers Only — \$12.99 #1478 Glove Only — \$5.99

Rugged and Precise Cutting

- 2 speeds give you complete control
- Serrated blades deliver clean, smooth cuts
- 5" blades with functional blade tip get into tight spaces or cut large steaks with ease
- 2 removable guide bars provide thickness control
 - 1 mm — SilverSkin remover
 - 3 mm — Jerky cuts (bonus)

Safety

- Blades lock into place and release with push of a button
- Soft grip over-mold design ensures a firm hold while reducing fatigue
- Pull trigger with safety lock
- 6' UL rated electric cord
- Cut Resistant Glove
- Dishwasher safe

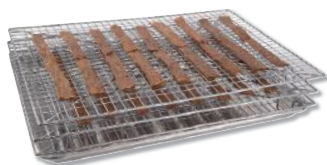

“Great item. Nice they go together so well.” — Alex K.

Jerky Rack & Pan

Make jerky in your oven! Each stackable 18" x 13" chrome plated rack has 1.5 sq. ft. of drying space and holds approximately one pound of meat. Use pan to catch drippings.

#407 Rack and Pan \$24.99
#408 Extra Rack \$12.49
#524 3 Racks and Pan \$44.99



Jerky Hanger

Holds over 100 sliced jerky strips. Includes 18" x 13" aluminum drip pan and a pack of Backwoods Jerky Seasoning with Cure. 9 stainless steel skewers. #735 — \$35.99



Jerky Knife & Board Kit

Sharp 10" blade and 7½" x 12" wood cutting board make it easy to slice consistently sized ¼" or ⅜" thick jerky strips. #616 — \$36.99



LEM Dehydrator

This 5-tray dehydrator is perfect for making small batches. It has a 48-hour digital timer and preset temperatures. With the clear lid and body, you can easily monitor the progress of your dehydrating. The chimney-like center allows for better air flow and helps with uniform drying. Includes 5 mesh tray overlays for drying smaller items. **ETL Certified.**

#1378 Plastic Trays with 3/4" holes \$79.99



The easy way to make Jerky and Snack Sticks

A. Jerky Cannon®

The best or nothing! The versatility of this tool intrigued folks from the beginning. Makes jerky, sausage, and even snack sticks. You can count on the Jerky Cannon® for years of performance. With thousands of customers, it's a proven winner!

Holds 1½ lb. of meat. **Includes: Jerky Nozzle, Snack Stick Nozzle, Backwoods Jerky & Snack Stick Seasoning and Nylon Brush**

#468 Jerky Cannon \$49.99

#468G Jerky Cannon Extra Barrel \$14.49 **TWO FOR \$22.99**

Compact, Yet Powerful

B. Jerky Gun

The heavy-duty drive system is designed to provide years of lasting performance. Holds ¾ lb. of meat and comes with one ½" round nozzle, one 1¾" x ¾" flat nozzle and one package of Backwoods Jerky seasoning for 5 lb. of meat.

#555 Jerky Gun \$32.99

#555A Jerky Gun 2 Pack Extra Barrels \$15.49



NEW! Jerky Cannon/Gun Disposable Bags

Faster and cleaner. Pre-fill several bags and have them ready and waiting in the refrigerator for your jerky making session. Clean up time is practically eliminated. Includes 10 disposable bags. 2" diameter by 16" long. String tied at one end.

#1491 10 ct. \$5.99



Check out our product video at
LEMproducts.com

STAINLESS STEEL NOZZLES & ACCESSORIES

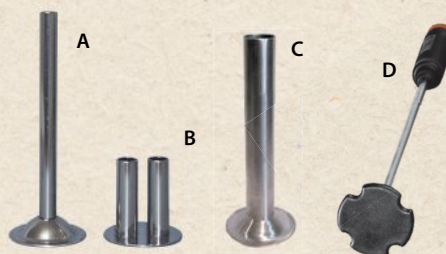

A. CUSTOMER FAVORITE! Snack Stick Nozzle ¾"

Use this nozzle to make snack sticks or breakfast links. Accepts 17 mm to 21 mm collagen or natural casings. 6" long. ½" O.D.
#468N — \$13.99

B. Double Snack Stick Nozzle

With or without casings, you can make two snack sticks at a time with this double nozzle. Has two ½" diameter tubes.
#468M — \$12.99

C. Sausage Stuffing Nozzle ¾"

Add this ¾" round sausage nozzle and turn your Cannon into a stuffer. Stuffs natural or collagen casings to make brats, metts, etc., or stuff fibrous casings to make summer sausage, bologna, etc. 6" long. ¾" O.D.
#468B — \$10.79

D. Barrel Stomper

Helps pack meat firmly in your Jerky Cannon® or Jerky Gun. No more air pockets. Stomper is 2" in diameter, handle is 12" long.
#468P — \$9.99



VICTORINOX®: TRUSTED QUALITY

VICTORINOX® Knives from Forschner

Makers of the Original Swiss Army Knife! Swiss forged stainless steel blades make them the choice of professional chefs and meat cutters worldwide. Ergonomic Fibrox™ plastic handles have a slip resistant design. **NSF Certified.**

	VICTORINOX® KNIVES	SKU #	PRICE
A	5" Curved, semi-stiff boning	#527	\$18.99
B	6" Curved, semi-stiff boning	#497	\$18.99
C	6" Straight, narrow, semi-flex boning	#498	\$18.99
D	6" Curved, wide, stiff boning	#499	\$18.99
E	8" Breaking knife	#500	\$27.49
F	10" Breaking knife	#501	\$32.99



G. Mundial 6" Serrated Ultimate Kitchen Knife

Professional quality for slicing bread, tomatoes or vegetables and for carving meat. **Staff favorite.** #037 — \$7.99 **TWO FOR \$14.00**



H. Cut Resistant Glove

Avoid nicks and cuts with a glove designed to protect your hand whenever you use a sharp instrument. Glove fits either hand.

#1478 Large \$5.99



More info & options at LEMproducts.com

USE WHAT THE PROFESSIONALS USE

Mundial Knives

Satisfaction is Guaranteed or We Refund Your Money. That's how strongly we feel about Mundial!

Mundial knives are designed for performance with comfort to minimize fatigue. Forged from high-carbon stainless steel, they deliver razor sharpness time and again. Every Mundial knife goes through a rigorous quality control program and carries a lifetime warranty. **NSF Certified.**

Mundial Knives	SKU#	PRICE
I 10" Breaking or Steak	#323	\$18.99
I 8" Breaking or Steak	#097	\$16.99
J 8" Filet	#096	\$12.99
K 6" Straight, narrow, semi-flex	#094	\$11.99
L 6" Curved, wide, stiff	#092	\$11.99
M 6" Curved, narrow, semi-flex	#091	\$11.99
M 5" Curved, narrow, semi-flex	#090	\$11.99
N 3¼" Paring	#098	\$5.99



O. Meat Cleaver 7"

The tough edges of the blade can withstand repeated blows directly into thick meat, sinew, and dense cartilage. **MADE IN USA.**

#1249 — \$44.99



Q. 4-Piece Mundial Hunter's Kit

Made by Mundial, kit includes a 3¼" paring knife, 5" curved boning knife, 8" steak knife and a 10" sharpening steel. Professional quality.

#099 — \$54.99



P. LEM EXCLUSIVE! 5-Piece Ceramic Knife Set

Blades slice even soft fruits and vegetables with ease. With no metallic content your food will stay fresher longer. Set includes four knives: 6" chef, 5" Santoku, 4" utility, 3" paring and handheld mandolin with hand guard. Safety sheath protects blades against accidental chipping. Hand wash for long lasting edge. **Hand guard not shown.**

#1064 — \$51.49



R. All-Purpose, Duo Edge Chef's Knife

A unique design allows you to cut, chop, or slice with less arm, hand, and wrist fatigue. Great solutions for those with arthritis or similar joint ailments. High carbon, polished stainless steel blade is honed for the ultimate edge. Corrosion resistant. 13" length with 8" blade. Knife guard included. **NSF Certified.**

Made in the USA.

#1188 — \$44.99



KEEP YOUR BLADES SHARP



Go Anywhere Knife & Sharpener

Safely and quickly hone all sorts of blades. V-shaped tungsten groove guides blade at correct angle—ensures efficient sharpening. Light and compact, it's convenient for the field. Features durable plastic construction and a finger guard.

#984 Orange Knife Sharpener — \$10.99

#1248 Knife & Sharpener Combo — \$36.49



Portable Countertop Knife Sharpener

So simple you can use it one-handed. Suction cup on the bottom adheres to any flat surface. Easy to store. **One Year Warranty.**

#980 — \$19.99

SILVERSKIN KNIFE KIT



NEW! SilverSkin Knife Kit

Effortlessly trim away silver skin for the best cuts! Silver skin is a thin membrane of tissue often found on venison or other game. It does not allow spices/marinades to permeate and unlike fat it will not melt away when cooked. If not removed it may leave meat gristly and gamey. The LEM Silver Skin Knife Kit includes safety glove, two blades, and purpose designed pliers to help you safely trim away silver skin so you can "eat better meat". **One Year Warranty. ETL Certified.**

#1475 Kit — \$79.99

#1477 Meat Gripping Pliers Only — \$12.99

#1478 Glove Only — \$5.99

Rugged and Precise Cutting

- 2 speeds give you complete control
- Serrated blades deliver clean, smooth cuts
- 5" blades with functional blade tip get into tight spaces or cut large steaks with ease
- 2 removable guide bars provide thickness control
 - 1 mm — SilverSkin remover
 - 3 mm — Jerky cuts (bonus)

Safety

- Blades lock into place and release with push of a button
- Soft grip over-mold design ensures a firm hold while reducing fatigue
- Pull trigger with safety lock
- 6' UL rated electric cord
- Cut Resistant Glove
- Dishwasher safe



Diamond Sharpeners

Available in three sizes. Quickly bring dull knives back to razor sharpness. The oval nickel-plated, tubular steel rod is covered with microcrystalline, industrial diamonds with a polypropylene handle with guard. 5" steel fits easily into a kitchen drawer or backpack.

A. #122 5" — \$20.99

B. #123 10" — \$31.99

C. #313 12" **BEST SELLER** — \$33.99

D. 12" Butcher Steel

Keep that razor edge on all your knives with this round, chrome plated steel. Easy-to-hold black, polypropylene handle. Compact size for easy storage.

#335 — \$26.99



More info & options at
LEMproducts.com



Electric Meat Saw
 .75 HP motor and a split table gives you a stationary back section and a sliding front section. Cuts pieces of meat up to 8" tall. A ½" stainless steel blade makes quick clean cuts through bone and meat. Adjustable thickness guide lets you cut steaks and roasts up to 8½" thick. Meat pushing guide holds meat and keeps hands safely behind the saw blade. Overall size is roughly 26" L x 21" W x 59" H. 110 Volts.
 *Some Assembly Required
#688 — \$849.99
 (add \$10.00 extra shipping)

Replacement Blade for Electric Saw
 Item not pictured.
#688A 77" long x 5/8" wide, 5 teeth per inch **\$18.99**



Commercial Grade Meat Saws

Choose from three sizes. Professional quality meat saws have a heavy, nickel-plated frame and a convenient cam-lock blade tightening lever that makes blade changing easy. Saws come with ½" blades.

Replacement Meat Saw Blades

- ½" wide—Standard blade with an easy cutting action (10 teeth per inch)
- 1" wide—A wide, sturdy blade for carcass splitting (10 teeth per inch)

Blade Length	Meat Saw		½" Blade		1" Blade	
	SKU#	PRICE	SKU#	PRICE	SKU#	PRICE
E 25"	#638	\$62.99	#638A	\$7.99	#638B	\$12.99
F 22"	#639	\$53.99	#639A	\$7.99	#639B	\$12.99
G 16"	#640	\$41.99	#640A	\$5.99	#640B	\$11.99

Stainless Steel Bone Duster

Removes the bone dust that can leave a bitter taste on your steaks and chops. Reversible blades permit scraping on either side.

#1132 — \$13.99



HOW TO KEEP YOUR KNIVES SHARP:

When steeling or sharpening a knife, steel at a 22° angle. Stand the steel straight up and place the tip on a cutting board. With your other hand, place the side of the knife's edge against the steel at a 22° angle. Push down at least five times and repeat for the other side. Be sure to do the same amount of strokes on each side.



**GRADUATED ADJUSTMENT
KNOB FOR PERFECT
THICKNESS EVERY TIME!**

Spring Loaded Burger Press

Easy patty removal every time! This burger press lets you make the perfect sized burger every time. Just adjust the knob from 1/4" to 1 1/4" thick, press together, and then spring the burger free. The patty will be 4 5/8" in diameter. Slip proof bottom to protect your table. For best results, use LEM Freeze Sheets to keep your burgers from freezing together. #1261 — \$26.99

Non-Stick burger press. **Item not pictured.**
#534 — \$24.99

 More info & options at
LEMproducts.com



LEM Freeze Sheets

Use to keep frozen foods from sticking together.
FDA APPROVED.

#027A 1000 - 6" x 10 3/4" Sheets \$13.99



Sausage and Meatloaf Seasoning

All purpose blend of spices and salt for a delicious flavor.

#9150 makes up to 24 lbs. \$4.99

#9151 makes up to 96 lbs. \$11.99



Pig Tail Flipper

The ingeniously designed snare lightly pierces any solid food. Lets you turn it with the flip of the wrist—faster and safer than hovering over flames with a grill fork! Handles almost anything from steaks to shrimp, even the large backstrap. The 19" Pig Tail is great for outdoor cooking. The 12" Pig Tail is a wizard at stovetop sautéing or griddle work.

#988 19" \$20.99

#989 12" \$12.99

#1045 — \$28.99 **BUY ONE OF EACH AND SAVE \$4.99**



Smoke Pistol

Use the SmokePistol™ smoke generator and get over four hours of smoke on a single cartridge. Fully controllable smoke output. Five cartridge flavors, three cartridges per pack. Cartridges and mounting plate sold separately.

#1050 Smoke Pistol \$46.99

#1051 Apple Flavor Cartridges \$6.99

#1052 Mesquite Flavor Cartridges \$6.99

#1054 Maple Flavor Cartridges \$6.99

#1057 Hickory Flavor Cartridges \$6.99

#1058 Cherry Flavor Cartridges \$6.99

#1060 Smoke Pistol Mounting Shelf \$5.99



Grill Kicker Barbeque Smoker— 100% Barbeque Flavor

Add authentic smoke flavor to steaks, burgers and chicken on any grill. Just insert a Grill Kicker cartridge of 100% fruitwood or hardwood pellets into the metal stand, place on the grill and close the lid. A single cartridge will fill your grill with 15 to 30 minutes worth of delicious barbeque flavor. Includes two hickory cartridges.

#1137 Grill Kicker with 2 Hickory Cartridges \$8.29

#1137A Hickory Refill Cartridges—Set of 4 \$6.19

 More info & options at
LEMproducts.com

BATTER UP!

Batter Bowl

Use to evenly batter seafood, meat, poultry or vegetables **without a mess or waste**. Holds up to 2 chicken breasts, ½ lb. of shrimp, 1 lb. of chicken wings, or 1 bundle of asparagus. Easy to clean. Durable. Top shelf dishwasher safe. Microwave safe. Lid locking mechanism. 12 ¾" L x 10 ¼" D x 8" H.

#1265 — \$14.99



Meat Shredders "The Claws"

Pull, Shred and Lift! Perfect for pulled pork, shredded chicken, lifting a turkey out of the roaster or even tossing a salad!

#1236 — \$10.49



Ben's Famous Sweet & Hot or Habanero Mustard

The perfect blend of sugar, vinegar and peppers makes this all-natural family recipe a true winner. Add a dollop to your sausage for some extra zing, spice up your deviled eggs, even glaze a ham. Ben's is locally made, Ohio proud and a four-time winner of the "Fiery Food Challenge". So, let your taste buds be the judge!

#1068 Sweet & Hot Mustard 8 oz. \$4.99

#1069 Sweet & Hot Mustard 16 oz. \$6.99

#1251 Habanero Mustard 8 oz. \$4.99

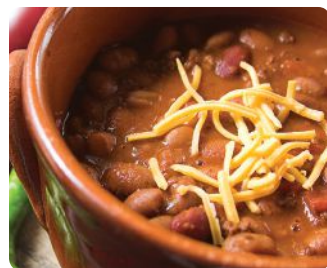

Backwoods Chili Mix

Use your choice of burger, add some spicy sausage per package directions, and you've got a great tasting chili. Spice it up as hot as you like it or keep it mild. Seasons 5 lbs. of meat. No salt. 2 oz. bag. #9776 — \$2.99



Gourmet Select Grillin' Rubs!

Formulated by Chef James Trent, each blend enhances the natural flavor of meat and wild game. If you're feeling inspired, try the recipes we've included on each label.

No additives. No MSG.

#891 Sizzlin' Honey BBQ Rib—4.95oz. \$10.49

#892 Savory Wild Game—4.48oz. \$10.49

#894 High Country Hickory Garlic—4.73oz. \$10.49

#895 Blackened Kickin' Chicken—4.73oz. \$10.49



4 oz. Injector with Two Needles

Commercial grade. All metal. Heavy duty, 4 oz. injector has a detachable 6" needle with 12 holes and a slant cut needle. Use it to pump pickling cure into meat or marinade into roasts or steaks. Great for injecting turkeys for frying. Built to last, you'll never buy another injector.

#839 — \$19.99



BIG BITE ELECTRIC SMOKER

Love that smoke-filled taste? You'll love the Big Bite Smoker, and the ability you have to control the smoke level. It is built with an innovative design that lets you control the smoke level (Normal and High) and dual dampers to control air flow. It has unparalleled heat consistency so you can set it and forget it. Want to make sure the temperature hasn't changed? Check the temperature look-back feature to see exactly what it has been for the past 4 hours. The spacious interior will let you cook large cuts of meat or hang rows of sausages from the two sausage rods. This electric smoker can smoke chips or pellets and you can re-load externally so you don't lose heat. It has a removable drip tray for easy clean-up. The back handle and wheels make it easy to move. Interior cooking capacity: 20 1/4" L x 12 1/2" D x 29 1/4" H.

ETL Certified. Five Year Warranty.

#1228 — \$489.99

(add \$20.00 extra shipping.
Ground shipping only.)



WARNING: Cancer and/or Reproductive Harm
www.p65warnings.ca.gov



MIGHTY BITE ELECTRIC SMOKER

Enjoy delicious smoked or slow cooked meats, cheeses, even fish without the hassle of propane or gas. Three removable racks are perfect for smoking turkeys, hams and tenderloins. Two top mounted cross bars allow you to hang sausages, snack sticks and even pork bellies. A built in thermometer and variable temperature dial that can be set as high as 350 degrees. Wood chip pan with slotted lid increases smoke production. Removable drip pan makes clean up easy. Side handles make it easy to move and 6" legs keep it elevated so you can clean it up without much effort. Includes five S hooks for sausage hanging. Cooking racks 14" x 14". Interior capacity 14 1/4" x 15 3/5" x 26 1/3". Some assembly required. **ETL Certified.**

Two Year Warranty.

#1292 — \$229.99

(add \$10.00 extra shipping)



WARNING: Cancer and/or Reproductive Harm
www.p65warnings.ca.gov

Sawdust

Bags may weigh less than designated weight due to drying of the product.

*Add \$8.00 extra shipping for 40 lb. bags.

#264 Hickory Sawdust, 5 lbs. \$6.19

#260 Hickory Sawdust, 40 lbs. \$30.99*

#259 Maple Sawdust, 5 lbs. \$6.19

#263 Maple Sawdust, 40 lbs. \$29.99*



WARNING: Cancer and/or Reproductive Harm
www.p65warnings.ca.gov

Liquid Smoke

Add hickory smoke flavor to every bite.
Highly concentrated smoke flavor.

#331 Pint \$5.49





CUSTOM BLENDED BACKWOODS[®] SEASONINGS

CUSTOMIZED BLENDS FOR THE PERFECT FLAVOR

We customize our seasonings to find the right blend so each one is unique. No two blends are alike, and each packet has just the right amount of seasoning.

We continuously test and refine the blend until it delivers the taste and flavor we expect.

Our seasoning experts make sure you get the quality you've come to expect from Backwoods. The team is constantly scouting for new seasoning flavors and won't stop bringing new seasonings for you to try!

BIG, BOLD Backwoods Flavor!



BACKWOODS KITS & VARIETY PACKS

Cured Sausage Kits

With Fibrous Casings. Seasoning with Cure. 1 lb. Fibrous Casings. String to tie open end of casings.

10 lb. Kit

- #9283 Summer Sausage Kit \$13.49
- #9285 Trail Bologna Kit \$13.49

20 lb. Kit

- #9284 Summer Sausage Kit \$22.99
- #9286 Trail Bologna Kit \$22.99

Fresh Sausage Kits

With Collagen Casings. Makes 20 lbs.

- #9562 Bratwurst Kit (32 mm Casings) \$17.49
- #9563 Breakfast Kit (21 mm Casings) \$17.49
- #9564 Sweet Italian Kit (32 mm Casings) \$17.49

Fresh Sausage Variety Pack

Makes 5 lbs. each of Breakfast, Hot Breakfast, Sweet Italian and Hot Italian.

- #9016 makes 20 lbs. \$11.49

Snack Stick Kits

With Collagen Casings. Seasoning with Cure. 21 mm Collagen Casings - makes 20 lbs.

- #9694 Snack Stick Kit \$22.99
- #9695 Hot Stick Kit \$22.99
- #9696 Pepper Stick Kit \$22.99

Snack Stick Variety Pack

Make 5 lbs. each of Regular, Hot, Pepper Sticks and Pepperoni. Try the Jerky Cannon or Jerky Gun to make the sticks. No casings needed. Make as little as 1 lb. at a time.

- #9387 makes 20 lbs. \$17.49



SAUSAGE SEASONINGS WITH CURE PACKET

Sticks

Snack Sticks

The original "Grab-n-Go" snack. Contains mustard.*+

- #9507 makes 5 lbs. \$6.49
- #9692 makes 20 lbs. \$17.49
- #9992 makes 100 lbs. \$61.99

Hot Stick

A stick with excellent flavor and heat for added enjoyment.*

- #9268 makes 5 lbs. \$6.49
- #9269 makes 20 lbs. \$17.49

Pepper Stick

A stick with kick.*

- #9271 makes 5 lbs. \$6.49
- #9630 makes 20 lbs. \$17.49

Summer Classics

Summer Sausage

This favorite delivers a tangy explosion of flavor. A sausage you'll make over and over again.*+

- #9508 makes 5 lbs. \$5.49
- #9385 makes 25 lbs. \$14.49
- #9991 makes 100 lbs. \$50.99

CUSTOMER FAVORITE! Jalapeño Summer Sausage

Traditional summer sausage with a kick of jalapeño peppers.*+

- #9025 makes 5 lbs. \$5.49
- #9040 makes 25 lbs. \$14.49
- #9994 makes 100 lbs. \$50.99

Trail Bologna

This Ohio original has a peppery finish that blends perfectly with cheddar cheese.*

- #9272 makes 5 lbs. \$5.49
- #9273 makes 25 lbs. \$14.49
- #9993 makes 100 lbs. \$50.99

Traditional

CUSTOMER FAVORITE! Bratwurst

A delicious sausage staple.*

- #9275 makes 5 lbs. \$5.49
- #9276 makes 25 lbs. \$14.49

Smoked Sausage

Savory goodness.*

- #9281 makes 5 lbs. \$5.49
- #9282 makes 25 lbs. \$14.49

Smoked Polish

Old World delicacy.*+

- #9279 makes 5 lbs. \$5.49
- #9280 makes 25 lbs. \$14.49

Andouille

This cajun sausage is often used in gumbos and similar dishes.*

- #9697 makes 5 lbs. \$5.49
- #9698 makes 25 lbs. \$14.49

Italian

Salami

Excellent lunchmeat.*

- #9277 makes 5 lbs. \$5.49
- #9278 makes 25 lbs. \$14.49

IMPROVED! Pepperoni

Put some "pop" in your pizza. Contains mustard.*

- #9509 makes 5 lbs. \$5.49
- #9465 makes 25 lbs. \$14.49

Family Favorites

Bologna

Kids favorite.*

- #9626 makes 5 lbs. \$5.49
- #9627 makes 25 lbs. \$14.49

Franks

Make your own hot dogs.*

- #9628 makes 5 lbs. \$5.49
- #9629 makes 25 lbs. \$14.49

* Contains No Gluten
+ Contains No MSG

ANY VARIETY OF
5 BAGS OR MORE
\$9.99 EACH



CHEESE THAT HOLDS UP DURING COOKING

CUSTOMER FAVORITE! High Temperature Cheese Chunks

This 100% real cheese is specially formulated to retain its shape and flavor up to 400°F. Pre-cut to ¼" chunks. Just add to your meat in a one to ten ratio (1 lb. cheese to 10 lbs. of meat) after the second grind, stuff and cook as usual. Cheese will last up to 12 months at 32–45°F and can be frozen. 1 lb. bag. Contains milk. Contains no gluten. Refrigerate upon receipt. *Sorry, cannot ship to Canada.*

#807 Cheddar \$10.49

#808 Hot Pepper \$10.49

#865 Swiss \$10.49

#1246 Habanero \$10.49

FRESH SAUSAGE SEASONINGS

Breakfast

CUSTOMER FAVORITE!

Breakfast

Great for breakfast or anytime. *

- #9002 makes 5 lbs. \$3.99
- #9006 makes 25 lbs. \$10.49
- #9996 makes 100 lbs. \$35.99

Hot Breakfast

Same terrific flavor as our breakfast blend, with an added kick of pepper.*

- #9003 makes 5 lbs. \$3.99
- #9007 makes 25 lbs. \$10.49

Maple

A delicious change to the normal breakfast sausage.*+

- #9624 makes 5 lbs. \$3.99
- #9013 makes 25 lbs. \$10.49

International

CUSTOMER FAVORITE!

Sweet Italian

A blend of pepper, fennel, and sugar.*+

- #9004 makes 5 lbs. \$3.99
- #9008 makes 25 lbs. \$10.49

Hot Italian

Crushed red pepper gives you an Italian sausage with extra zing.*+

- #9005 makes 5 lbs. \$3.99
- #9009 makes 25 lbs. \$10.49

Chorizo

A favorite Mexican sausage with heat and a spicy flavor.*+

- #9266 makes 5 lbs. \$3.99
- #9010 makes 25 lbs. \$10.49

Polish

A traditional flavor.*+

- #9267 makes 5 lbs. \$3.99
- #9011 makes 25 lbs. \$10.49

Traditional

Kielbasa

A traditional blend of garlic, herbs, and pepper. Contains mustard.*+

- #9087 makes 5 lbs. \$3.99
- #9018 makes 25 lbs. \$10.49

CUSTOMER FAVORITE!

Bratwurst

A delicious sausage. Use beer instead of water for extra flavor.*

- #9389 makes 5 lbs. \$3.99
- #9012 makes 25 lbs. \$10.49
- #9995 makes 100 lbs. \$35.99

Garlic

The bold flavor of this seasoning won't disappoint.*+

- #9086 makes 5 lbs. \$3.99
- #9015 makes 25 lbs. \$10.49

Cajun

Onion, garlic and three kinds of pepper make this a real hit for Cajun lovers.*+

- #9699 makes 5 lbs. \$3.99
- #9014 makes 25 lbs. \$10.49

Chipotle Bourbon

A hint of heat with a touch of sweet – the perfect addition to your sausage.*+

- #9142 makes 5 lbs. \$3.99
- #9145 makes 25 lbs. \$10.49

Garlic Chili Pepper

Full of flavor and spice, you get a hint of garlic and spicy pepper.*+

- #9140 makes 5 lbs. \$3.99
- #9143 makes 25 lbs. \$10.49

Sausage and Meatloaf Seasoning

All purpose blend of spices and salt for a delicious flavor.

- #9150 makes up to 24 lbs. \$4.99
- #9151 makes up to 96 lbs. \$11.99



BACON!

Bacon Cures

Make your own at home! Rub it on or mix up a brine. Our cures work on all types of meat. Enough to cure 25 lbs.

- #9122 Original Dry Rub \$8.49
- #9133 Smoked Brine \$8.49

- #9134 Maple \$10.49+
- #9135 Cracked Pepper \$10.49+
- #9136 Jalapeño \$13.49+

* Can be used as a dry rub or brine.

Venison Bacon Seasoning

Turn any lean ground meat into bacon!

- #9137 makes 25 lbs. \$8.49

REDUCED SODIUM SEASONINGS

25% less sodium vs. our regular seasoning.

Reduced Sodium Summer Sausage* +

- #9159 makes 5 lbs. \$5.49
- #9160 makes 25 lbs. \$14.49

Reduced Sodium Original Jerky*

- #9152 makes 5 lbs. \$5.49
- #9158 makes 25 lbs. \$15.49

Reduced Sodium Original Snack Stick* +

- #9161 makes 5 lbs. \$6.49
- #9162 makes 20 lbs. \$17.49

Reduced Sodium Breakfast*

- #9163 makes 5 lbs. \$3.99
- #9164 makes 25 lbs. \$10.49

THE LITTLE EXTRAS MAKE THE DIFFERENCE

Binders

Soy Protein Concentrate

Retain moisture, prevent shrinkage and render a juicy sausage.*+

- #9484 1 lb. bag for 50 lbs. meat. \$5.49

FREEbind

Made from potato and carrot extracts. Allergen free: soy and gluten-free.*+

- #1208 6 oz. bag for 25 lbs. meat. \$4.49

CUSTOMER FAVORITE!

LEM Cure

Control botulism while adding color and flavor to your smoked or cooked sausage. (All Backwoods Seasonings requiring cure come with pre-measured packages.)*+

- #9208 4 oz. bag for 100 lbs. meat. \$2.49

Encapsulated Citric Acid

Speeds drying time and adds flavor. Use to make dry, shelf-stable sausage. Follow directions on package.*+

- #9964 3 oz. bag for 25 lbs. meat. \$5.99

Beer Buds

Add beer flavor to your sausage without additional liquid.†

- #9138 4.8 oz. \$6.49

Trehalose

A natural sweetener and anti-oxidant, it will help take the "wild" out of the game. Use 6 oz. for 25 lbs. Use with fresh and cured sausages.*+

- #9965 6 oz. bag for 25 lbs. meat. \$5.99



More info & options at
LEMproducts.com



JERKY SEASONINGS WITH CURE PACKET

We make it simple with our easy to follow instructions and pre-measured cure in every package. Marinate strips or mix with ground meat and use with our famous Jerky Cannon®.

Original

A classic. LEM's exclusive blend brings this traditional recipe to new heights.*

- #9064 makes 5 lbs. \$5.49
- #9620 makes 25 lbs. \$15.49
- #9990 makes 100 lbs. \$46.99

Mesquite

Native to Texas and much of Mexico, this smoky southwest flavor is not to be missed.*

- #9153 makes 5 lbs. \$5.49
- #9621 makes 25 lbs. \$15.49

Jalapeño

Experience the fiery flavor of this Mexican pepper.*+

- #9023 makes 5 lbs. \$5.49
- #9043 makes 25 lbs. \$15.49

Teriyaki

Strong hints of brown sugar give this popular Asian blend a sweet finish. Contains Soy.

- #9083 makes 5 lbs. \$5.49
- #9085 makes 25 lbs. \$15.49

Hot

The flavor is derived from our Original blend and its heat from crushed red peppers.*

- #9155 makes 5 lbs. \$5.49
- #9623 makes 25 lbs. \$15.49

Cajun

Bayou classic—a blend of celery, onion & cayenne pepper.*+

- #9022 makes 5 lbs. \$5.49
- #9042 makes 25 lbs. \$15.49

Hickory

This seasoning carries a rich, slightly sweet flavor infused with the inviting aroma of hickory smoke.*

- #9154 makes 5 lbs. \$5.49
- #9622 makes 25 lbs. \$15.49

Cracked Pepper

Cracked peppercorns add a kick. Contains mustard.*+

- #9024 makes 5 lbs. \$5.49
- #9044 makes 25 lbs. \$15.49

BBQ

Smoky spices come together in a perfect blend for BBQ lovers.*+

- #9021 makes 5 lbs. \$5.49
- #9041 makes 25 lbs. \$15.49

Sriracha

Spice it up Asian style with this blend of red chilies and garlic.*+

- #9088 makes 5 lbs. \$5.49
- #9089 makes 25 lbs. \$15.49

Caribbean Jerk

Bring the spice and heat of the islands to your jerky.*+

- #9147 makes 5 lbs. \$5.49
- #9149 makes 25 lbs. \$15.49

Sweet & Hot

Starts with a little kick and ends with a little sweet.*+

- #9141 makes 5 lbs. \$5.49
- #9144 makes 25 lbs. \$15.49



Four Flavor Jerky Variety Packs

Four popular jerky blends in one package. Pack includes enough to make 5 lbs. each. Makes 20 lbs.

Original, Hot, Mesquite, and Hickory.

#9156 — \$14.49

Cajun, Jalapeño, Cracked Pepper and Teriyaki.

#9157 — \$14.49

- * Contains No Gluten
- + Contains No MSG



SAVE ON BULK SPICES!

All spices are packaged in a pint size container with shaker and spoon-out lid.

Sage

#458 Rubbed. 6 oz. \$9.49

Coriander

#441 Ground. 15 oz. \$7.49

Fennel Seed

#444 Whole. 14 oz. \$9.49

Jalapeño

#719 Dried. 6 oz. \$8.99

Red Pepper

#455 Crushed. 14 oz. 11.99

Mustard Seed

#448 Whole. 24 oz. \$9.49

Pepper

#454 Black Ground 42 mesh. 16 oz. \$13.99

Peppercorns

#456 Whole Black. 19 oz. \$15.99



LEM GRINDER PLATES & KNIVES

LEM carries a comprehensive inventory of replacement blades and plates to keep your machine grinding at peak performance. Choose from carbon steel, stainless steel, or our premium Salvinox brand. All plates can be used on either side. Which plate do you need? What hole size is best for you? Visit our website at lemproducts.com and find our full assortment of plates and knives as well as answers to your questions and even a handy printable sizing guide. For more information about our full line of grinder replacement plates and blades, see page 7.



CUSTOMER FAVORITE! Grinder Foot Switch

Grind hands-free! Just plug grinder into pedal, then plug the pedal into 110 V outlet. Works great with LEM's Ground Meat Packaging System or when stuffing casings from your grinder. Cord length 8'. **UL Listed.**

#724 — \$41.99



Ground Meat Packaging System With Stainless Steel Tube

Everything you need to package your ground meat in half the time it takes to freezer wrap it. Save when you buy these must-have items as a kit. Kit includes a bag taping machine, one roll of poly tape, and 50 one-pound wild game bags. **See page 26.**



A. Grinder Accessories Kit WITH 10 BRUSHES

Comes with everything you will need to get the most efficient use out of your electric grinder. Kit contains: Poly Bag Tape Machine & Tape, 50- 1 lb. Wild Game Bags, Grinder Foot Switch, and Grinder Cleaning Kit to help you keep your grinder running and looking like new.

#819 — \$69.99 *Sorry, express shipping not available. Cannot ship outside the contiguous U.S. or to California.*

FOR MORE INFORMATION ON OUR LINE OF BIG BITE GRINDERS SEE PAGE 4, 5.



LEM Products
 4440 Muhlhauser Rd.
 Suite 300
 West Chester, OH 45011
 877.536.7763

PRESORTED
 STANDARD
 U.S. Postage Paid
 LEM Products

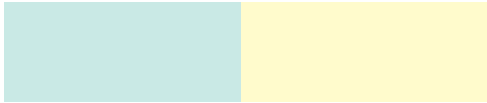

Customer Number

Key Code



BIG BITE[®] DIGITAL DEHYDRATOR

See on page 15



Scan To Purchase

NEW! Big Bite[®] Digital Stainless Steel Dehydrator

If you love making jerky, snack sticks or other dried foods you should get to know the Big Bite Digital Dehydrator. The high capacity stainless steel design has 16 sq./ft of drying space and “whisper quiet” rear mounted fan for fast drying. An advanced digital display to set time and temperature in a snap. Patented front panel that slides and locks in place so you can remove trays or check on your progress with minimal heat loss. Comes with 10 chrome plated or stainless trays. The solid construction and innovative design make it worthy of its Big Bite name. **Five Year Warranty. ETL Certified. Drip Tray Included.**

#1154 Chrome Plated Trays with ¼” holes — \$369.99 (add \$10.00 extra shipping) #1154SS Stainless Steel Trays with ¼” holes — \$429.99 (add \$10.00 extra shipping)

FIND MORE INFORMATION ON OUR FULL LINE OF DEHYDRATORS ON PAGE 14, 15