

**OCD**

4 Drawer Cabinet Only  
(Less Drawers)

**OCD-2**

2 Drawer Cabinet Only  
(Less Drawers)

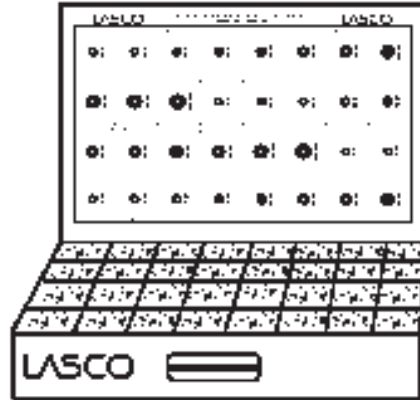
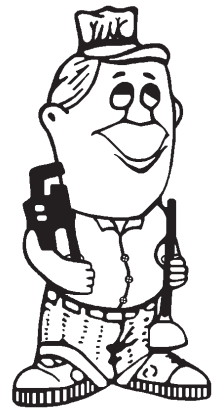

**OCD0**

Drawer For Cabinet  
w/ 32 Compartments

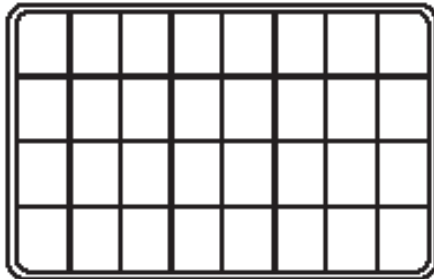

**OCD00**

32 Compartments  
Plastic Insert

**WASHER CABINETS**

# LASCO

## Washers & Parts Cabinets

### Drawers Available

To Order Insert Card Only Add "I" To The Number

- |  |  |
|--|--|
| ★ <b><u>BBAW1</u></b> Bibb Washers   | <b><u>BBAW15</u></b> O' Rings                |
| <b><u>BBAW11</u></b> Bibb Washers, No Rotate Washers, Retainer Cups, Bibb Screws | ★ <b><u>BBAW6</u></b> Handle and Bibb Screws |
| ★ <b><u>BBAW2</u></b> Nylon, Fiber Washers                                       | ★ <b><u>BBAW7</u></b> Square Cut Packing     |
| <b><u>BBAW12</u></b> Nylon, Fiber Washers  | <b><u>BBAW17</u></b> Square Cut Packing      |
| ★ <b><u>BBAW3</u></b> Seats  | ★ <b><u>BBAW8</u></b> Faucet Parts           |
| <b><u>BBAW13</u></b> Seats   | <b><u>BBAW9</u></b> Fitting Washers Etc.     |
| ★ <b><u>BBAW4</u></b> Cone Washers   | ★ <b><u>BBAW41</u></b> Buttons               |
| ★ <b><u>BBAW5</u></b> O' Rings   | <b><u>BBAW42</u></b> Buttons                 |

★ Indicates Most Popular



# BIBB WASHER ASSORTMENT

BBAW1 DRAWER

LASCO

LASCO

ITEM	DESCRIPTION	QTY.	ITEM	DESCRIPTION	QTY.
02-1070	00 Beveled Bibb Washers	100	02-1110	3/8M Flat Bibb Washer	100
02-1072	0 Beveled Bibb Washers	100	02-1112	3/8L Flat Bibb Washer	100
02-1074	1/4 Beveled Bibb Washers	100	02-1114	1/2 Flat Bibb Washer	100
02-1076	1/4L Beveled Bibb Washers	100	02-1116	1/2L Flat Bibb Washer	100
02-1078	3/8 Beveled Bibb Washers	100	02-1118	5/8 Flat Bibb Washer	100
02-1080	3/8M Beveled Bibb Washers	100	02-1120	5/8L Flat Bibb Washer	100
02-1082	3/8L Beveled Bibb Washers	100	02-1160	W-109A 1/8 Flat Pignose Washers	100
02-1084	1/2 Beveled Bibb Washers	100	02-1162	W-110A 00 Flat Pignose Washers	100
02-1086	1/2L Beveled Bibb Washers	100	02-1164	W-110AB 0 Flat Pignose Washers	100
02-1088	5/8 Beveled Bibb Washers	100	02-1166	W-111A 1/4 Flat Pignose Washers	100
02-1090	5/8L Beveled Bibb Washers	100	02-1168	W-112A 1/4L Flat Pignose Washers	100
02-1100	00 Flat Bibb Washer	100	02-1170	W-113A 3/8 Flat Pignose Washers	100
02-1102	0 Flat Bibb Washer	100	02-1172	W-113AB 3/8M Flat Pignose Washers	100
02-1104	1/4 Flat Bibb Washer	100	02-1174	W-114A 3/8L Flat Pignose Washers	100
02-1106	1/4L Flat Bibb Washer	100	02-1176	W-115A Flat Pignose Washers	50
02-1108	3/8 Flat Bibb Washer	100	0CDO	Drawer for Cabinet W/32 Holes	1



































BIBB WASHER ASSORTMENT

BBAW11 DRAWER

LASCO

LASCO

ITEM	DESCRIPTION	QTY.	ITEM	DESCRIPTION	QTY.
XS-552	S-6 1/2 x 8-32 Brass Screw	12	02-1232	0 No-Rotate Washers	24
XS-553	S-9 3/8 x 10-24 Brass Screw	24	02-1234	1/4 No-Rotate Washers	12
XS-554	S-5 1/2 x 10-24 Brass Screw	24	02-1236	1/4L No-Rotate Washers	12
XS-555	S-8 3/8 x 8-32 Brass Screw	24	02-1238	3/8 No-Rotate Washers	12
XS-556	3/8 x 10-28 Brass Screw	12	02-1240	3/8M No-Rotate Washers	12
XS-558	S-7 3/8 x 10-32 Brass Screw	12	02-1242	3/8L No-Rotate Washers	24
XS-559	S-4 1/2 x 10-32 Brass Screw	12	02-1244	1/2 No-Rotate Washers	12
XS-560	S-3 3/8 x 6-32 Brass Bibb Screw	12	02-1336	00 Brass Retainer Cup	50
02-1130	W-89A 1/8 Beveled Pignose Washers	50	02-1338	0 Brass Retainer Cup	24
02-1132	W-90A 00 Beveled Pignose Washers	50	02-1340	1/4 Brass Retainer Cup	24
02-1134	W-90AB 0 Beveled Pignose Washers	50	02-1342	1/4L Brass Retainer Cup	24
02-1136	W-91A 1/4 Beveled Pignose Washers	50	02-1344	3/8 Brass Retainer Cup	24
02-1138	W-92A 1/4L Beveled Pignose Washers	50	02-1346	3/8L Brass Retainer Cup	24
02-1140	W-93A 3/8 Beveled Pignose Washers	50	02-1348	1/2 Brass Retainer Cup	24
02-1144	W-95A 3/8L Beveled Pignose Washers	50	02-1350	1/2L Brass Retainer Cup	12
02-1146	W-96A 1/2 Beveled Pignose Washers	50	OCD0	Drawer for Cabinet W/32 Holes	1
02-1230	00 No-Rotate Washers	24			

NYLON & FIBER ASSORTMENT

BBAW2 DRAWER



<p>DWGCD # K.R.R.P. PSM # 17612</p> <p>GLU. ILL. THCK 21/32 1/4 1/82</p> <p>AMERICAN STANDARD PRICE PER 1000</p> <p>LASCO # 02-1894 ASBESTOS \$</p>	<p>DWGCD # K.R.R.P. PSM # 3/4 3/8 1/8</p> <p>GLU. ILL. THCK</p> <p>MISCELLANEOUS</p> <p>LASCO # 02-1814 FIBER \$</p>	<p>DWGCD # K.R.R.P. PSM # 1 13/32 1/16</p> <p>GLU. ILL. THCK</p> <p>MISCELLANEOUS</p> <p>LASCO # 02-1848 FIBER \$</p>	<p>DWGCD # K.R.R.P. PSM # 29/32 7/16 1/16</p> <p>GLU. ILL. THCK</p> <p>MISCELLANEOUS</p> <p>LASCO # 02-1846 FIBER \$</p>	<p>DWGCD # K.R.R.P. PSM # 3/4 1/2 1/32</p> <p>GLU. ILL. THCK</p> <p>MISCELLANEOUS</p> <p>LASCO # 02-1872 FIBER \$</p>	<p>DWGCD # K.R.R.P. PSM # 13/16 1/2 1/32</p> <p>GLU. ILL. THCK</p> <p>MISCELLANEOUS</p> <p>LASCO # 02-1868 FIBER \$</p>	<p>DWGCD # K.R.R.P. PSM # 13/16 1/2 1/16</p> <p>GLU. ILL. THCK</p> <p>MISCELLANEOUS</p> <p>LASCO # 02-1816 FIBER \$</p>	<p>DWGCD # K.R.R.P. PSM # 11/16 9/16 1/32</p> <p>GLU. ILL. THCK</p> <p>MISCELLANEOUS</p> <p>LASCO # 02-1862 NYLON \$</p>
<p>DWGCD # K.R.R.P. PSM # 15/16 19/32 1/16</p> <p>GLU. ILL. THCK</p> <p>MISCELLANEOUS</p> <p>LASCO # 02-1818 FIBER \$</p>	<p>DWGCD # K.R.R.P. PSM # 23/32 5/8 1/32</p> <p>GLU. ILL. THCK</p> <p>PRICE PER 1000-98 KOHLER, MULLER, KALKE</p> <p>LASCO # 02-1838 NYLON \$</p>	<p>DWGCD # K.R.R.P. PSM # 13/16 5/8 1/32</p> <p>GLU. ILL. THCK</p> <p>REPCAL OVERFITTER PRICE PER 1000-98</p> <p>LASCO # 02-1870 FIBER \$</p>	<p>DWGCD # K.R.R.P. PSM # 7/8 5/8 1/8</p> <p>GLU. ILL. THCK</p> <p>REPCAL OVERFITTER</p> <p>LASCO # 02-1836 NYLON \$</p>	<p>DWGCD # K.R.R.P. PSM # 15/16 5/8 1/16</p> <p>GLU. ILL. THCK</p> <p>PRICE PER 1000-98</p> <p>LASCO # 02-1808 NYLON \$</p>	<p>DWGCD # K.R.R.P. PSM # 13/16 23/32 1/32</p> <p>GLU. ILL. THCK</p> <p>KOHLER</p> <p>LASCO # 02-1832 COPPER \$</p>	<p>DWGCD # K.R.R.P. PSM # 1 5/8 1/16</p> <p>GLU. ILL. THCK</p> <p>MISCELLANEOUS</p> <p>LASCO # 02-1834 FIBER \$</p>	<p>DWGCD # K.R.R.P. PSM # 7/8 3/4 1/16</p> <p>GLU. ILL. THCK</p> <p>PRICE PER 1000-16</p> <p>LASCO # 02-1842 NYLON \$</p>
<p>DWGCD # K.R.R.P. PSM # 13/16 3/4 1/16</p> <p>GLU. ILL. THCK</p> <p>MISCELLANEOUS</p> <p>LASCO # 02-1956 FIBER \$</p>	<p>DWGCD # K.R.R.P. PSM # W-398-37G 17654</p> <p>GLU. ILL. THCK</p> <p>ELKER, REPCAL</p> <p>LASCO # 02-1804 NYLON \$</p>	<p>DWGCD # K.R.R.P. PSM # W-401A 17660</p> <p>GLU. ILL. THCK</p> <p>ELKER, REPCAL</p> <p>LASCO # 02-1840 FIBER \$</p>	<p>DWGCD # K.R.R.P. PSM # W-398-16D 17657</p> <p>GLU. ILL. THCK</p> <p>1/2" IN. H.C. CORNER KOHLER, REPCAL PRICE PER 1000-98</p> <p>LASCO # 02-1844 FIBER \$</p>	<p>DWGCD # K.R.R.P. PSM # 1 13/16 1/16</p> <p>GLU. ILL. THCK</p> <p>BREXID, 303V LILE</p> <p>LASCO # 02-1812 FIBER \$</p>	<p>DWGCD # K.R.R.P. PSM # 1-1/32 7/8 1/16</p> <p>GLU. ILL. THCK</p> <p>PRICE PER 1000-98 CORNER</p> <p>LASCO # 02-1806 FIBER \$</p>	<p>DWGCD # K.R.R.P. PSM # 1-3/32 7/8 1/16</p> <p>GLU. ILL. THCK</p> <p>1/2" IN. H.C. AMERICAN STANDARD CORNER, REPCAL</p> <p>LASCO # 02-1826 FIBER \$</p>	<p>DWGCD # K.R.R.P. PSM # 1-3/16 7/8 1/16</p> <p>GLU. ILL. THCK</p> <p>PRICE PER 1000-98 BRASS TRAYLINE SPECIAL OVERHEAD</p> <p>LASCO # 02-1822 NYLON \$</p>
<p>DWGCD # K.R.R.P. PSM # 1-5/62 31/62 1/16</p> <p>GLU. ILL. THCK</p> <p>AMERICAN STANDARD KOHLER</p> <p>LASCO # 02-1866 FIBER \$</p>	<p>DWGCD # K.R.R.P. PSM # 1-9/64 1 1/16</p> <p>GLU. ILL. THCK</p> <p>PRICE PER 1000-98</p> <p>LASCO # 02-1820 NYLON \$</p>	<p>DWGCD # K.R.R.P. PSM # W-418A 17733</p> <p>GLU. ILL. THCK</p> <p>PRICE PER 1000-98 OVERFITTER, REPCAL, JORDANHEAD</p> <p>LASCO # 02-1824 FIBER \$</p>	<p>DWGCD # K.R.R.P. PSM # 1-1/4 1-1/16 1/8</p> <p>GLU. ILL. THCK</p> <p>GENIE KOHLER CORNER PRICE PER 1000-98</p> <p>LASCO # 02-1858 FIBER \$</p>	<p>DWGCD # K.R.R.P. PSM # 1-1/2 1-1/4 1/32</p> <p>GLU. ILL. THCK</p> <p>MISCELLANEOUS</p> <p>LASCO # 02-1852 FIBER \$</p>	<p>DWGCD # K.R.R.P. PSM # 1-9/16 15/32 1/16</p> <p>GLU. ILL. THCK</p> <p>MISCELLANEOUS</p> <p>LASCO # 02-1830 FIBER \$</p>	<p>DWGCD # K.R.R.P. PSM # 1-11/16 1-7/16 1/16</p> <p>GLU. ILL. THCK</p> <p>MISCELLANEOUS</p> <p>LASCO # 02-1828 FIBER \$</p>	<p>DWGCD # K.R.R.P. PSM # 1-15/16 1-11/16 1/32</p> <p>GLU. ILL. THCK</p> <p>MISCELLANEOUS</p> <p>LASCO # 02-1854 FIBER \$</p>

02-AW-2

































ITEM	DESCRIPTION	QTY.	ITEM	DESCRIPTION	QTY.
02-1804	#36 Nylon Washer	24	02-1840	#37 Fiber Washer	24
02-1806	#41 Fiber Washer	24	02-1842	#35 Nylon Washer	24
02-1808	#31 Nylon Washer	24	02-1844	#38 Fiber Washer	24
02-1812	#39 Fiber Washer	24	02-1846	#15 Fiber Washer	24
02-1814	#5 Fiber Washer	24	02-1848	#10 Fiber Washer	24
02-1816	#23 Fiber Washer	24	02-1852	#56 Fiber Washer	24
02-1818	#26 Fiber Washer	24	02-1854	#63 Fiber Washer	24
02-1820	#47 Nylon Washer	24	02-1858	#50 Fiber Washer	24
02-1822	#43 Nylon Washer	24	02-1862	#24 Nylon Washer	24
02-1824	#48 Fiber Washer	24	02-1866	#46 Fiber Washer	24
02-1826	#42 Fiber Washer	24	02-1868	#22 Fiber Washer	24
02-1828	#60 Fiber Washer	24	02-1870	#29 Fiber Washer	24
02-1830	#57 Fiber Washer	24	02-1872	#21 Fiber Washer	24
02-1832	#32 Fiber Washer	24	02-1894	#1 Asbestos Washer	24
02-1834	#33 Fiber Washer	24	02-1956	#34 Fiber Washer	24
02-1836	#30 Nylon Washer	24	0CDO	Drawer for Cabinet W/32 Holes	1
02-1838	#28 Nylon Washer	24			



NYLON & FIBER ASSORTMENT

BBAW12 DRAWER



<p>DWGCD # K.R.K.P. PS&amp;P 17168</p> <p>GLL ILL THCK 1/2 3/8 3/32</p>  <p>PRICE PER 5/8" 330430</p> <p>LASCO #02-7508 FIBER \$</p>	<p>DWGCD # K.R.K.P. PS&amp;P 17630</p> <p>GLL ILL THCK 23/32 3/8 1/8</p>  <p>MISCELLANEOUS</p> <p>LASCO #02-1864 FIBER \$</p>	<p>DWGCD # K.R.K.P. PS&amp;P 11901</p> <p>GLL ILL THCK 3/4 3/8 1/32</p>  <p>AMERICAN STANDARD 1204-01</p> <p>LASCO #02-1288 NYLON \$</p>	<p>DWGCD # K.R.K.P. PS&amp;P</p> <p>GLL ILL THCK 29/32 11/32 1/16</p>  <p>MISCELLANEOUS</p> <p>LASCO #02-1874 FIBER \$</p>	<p>DWGCD # K.R.K.P. PS&amp;P W-410XA</p> <p>GLL ILL THCK 1-1/32 3/8 1/32</p>  <p>MISCELLANEOUS</p> <p>LASCO #02-1880 FIBER \$</p>	<p>DWGCD # K.R.K.P. PS&amp;P W-398-29E</p> <p>GLL ILL THCK 29/32 13/32 1/16</p>  <p>GERBER KOHLER 5164145</p> <p>LASCO #02-1876 FIBER \$</p>	<p>DWGCD # K.R.K.P. PS&amp;P P-98-18</p> <p>GLL ILL THCK 29/32 13/32 1/16</p>  <p>NOVINA</p> <p>LASCO #02-1670 FIBER \$</p>	<p>DWGCD # K.R.K.P. PS&amp;P</p> <p>GLL ILL THCK 1 13/32 1/16</p>  <p>MISCELLANEOUS</p> <p>LASCO #02-1848 FIBER \$</p>
<p>DWGCD # K.R.K.P. PS&amp;P W-398-29D</p> <p>GLL ILL THCK 21/32 7/16 1/32</p>  <p>MISCELLANEOUS</p> <p>LASCO #02-1800 FIBER \$</p>	<p>DWGCD # K.R.K.P. PS&amp;P P-98-21</p> <p>GLL ILL THCK 13/16 7/16 1/16</p>  <p>AMERICAN STANDARD 9981-01</p> <p>LASCO #02-1674 FIBER \$</p>	<p>DWGCD # K.R.K.P. PS&amp;P P-98-22</p> <p>GLL ILL THCK 7/8 7/16 1/16</p>  <p>MISCELLANEOUS</p> <p>LASCO #02-1676 FIBER \$</p>	<p>DWGCD # K.R.K.P. PS&amp;P P-98-16</p> <p>GLL ILL THCK 31/32 7/16 3/32</p>  <p>MISCELLANEOUS</p> <p>LASCO #02-1668 FIBER \$</p>	<p>DWGCD # K.R.K.P. PS&amp;P W-398-18C</p> <p>GLL ILL THCK 31/32 7/16 3/32</p>  <p>MISCELLANEOUS</p> <p>LASCO #02-1878 FIBER \$</p>	<p>DWGCD # K.R.K.P. PS&amp;P P-98-23</p> <p>GLL ILL THCK 1-1/16 7/16 1/16</p>  <p>REPCAL</p> <p>LASCO #02-1896 FIBER \$</p>	<p>DWGCD # K.R.K.P. PS&amp;P P-98-24</p> <p>GLL ILL THCK 1-1/8 7/16 1/16</p>  <p>MISCELLANEOUS</p> <p>LASCO #02-1850 FIBER \$</p>	<p>DWGCD # K.R.K.P. PS&amp;P</p> <p>GLL ILL THCK 21/32 1/2 1/32</p>  <p>MISCELLANEOUS</p> <p>LASCO #02-1802 FIBER \$</p>
<p>DWGCD # K.R.K.P. PS&amp;P 17632</p> <p>GLL ILL THCK 11/16 9/16 1/32</p>  <p>HARDON 1</p> <p>LASCO #02-1862 NYLON \$</p>	<p>DWGCD # K.R.K.P. PS&amp;P</p> <p>GLL ILL THCK 29/32 9/16 1/8</p>  <p>MISCELLANEOUS</p> <p>LASCO #02-1860 FIBER \$</p>	<p>DWGCD # K.R.K.P. PS&amp;P</p> <p>GLL ILL THCK 15/16 19/32 1/8</p>  <p>PRICE PER 5/8"</p> <p>LASCO #02-7504 FIBER \$</p>	<p>DWGCD # K.R.K.P. PS&amp;P</p> <p>GLL ILL THCK 15/16 7/8 1/16</p>  <p>PRICE PER 5/8" 34930</p> <p>LASCO #02-7506 FIBER \$</p>	<p>DWGCD # K.R.K.P. PS&amp;P W-398-52F 17725</p> <p>GLL ILL THCK 1-1/32 31/32 1/32</p>  <p>BRIGGS KOHLER ELER</p> <p>LASCO #02-1810 FIBER \$</p>	<p>DWGCD # K.R.K.P. PS&amp;P 17781</p> <p>GLL ILL THCK 1-1/8 31/32 1/32</p>  <p>KOHLER 9801</p> <p>LASCO #02-7602 FIBER \$</p>	<p>DWGCD # K.R.K.P. PS&amp;P</p> <p>GLL ILL THCK 1-13/16 1 1/32</p>  <p>PRICE PER 5/8" 330430</p> <p>LASCO #02-7500 NYLON \$</p>	<p>DWGCD # K.R.K.P. PS&amp;P 17747</p> <p>GLL ILL THCK 1-1/2 1-1/16 1/32</p>  <p>ALCOHOL 01</p> <p>LASCO #02-7620 NYLON \$</p>
<p>DWGCD # K.R.K.P. PS&amp;P W-416A</p> <p>GLL ILL THCK 1-3/8 1-1/8 1/32</p>  <p>MISCELLANEOUS</p> <p>LASCO #02-1950 FIBER \$</p>	<p>DWGCD # K.R.K.P. PS&amp;P</p> <p>GLL ILL THCK 1-1/4 1-1/8 1/32</p>  <p>AMERICAN STANDARD 9981-01</p> <p>LASCO #02-7600 NYLON \$</p>	<p>DWGCD # K.R.K.P. PS&amp;P W-408A</p> <p>GLL ILL THCK 1-1/2 1-3/16 1/16</p>  <p>MISCELLANEOUS</p> <p>LASCO #02-1954 FIBER \$</p>	<p>DWGCD # K.R.K.P. PS&amp;P W-406A</p> <p>GLL ILL THCK 1-7/16 1-1/4 1/16</p>  <p>MISCELLANEOUS</p> <p>LASCO #02-1952 FIBER \$</p>	<p>DWGCD # K.R.K.P. PS&amp;P</p> <p>GLL ILL THCK 2-1/4 1-3/8 1/32</p>  <p>AMERICAN STANDARD 9981-01</p> <p>LASCO #02-7610 FIBER \$</p>	<p>DWGCD # K.R.K.P. PS&amp;P</p> <p>GLL ILL THCK 1-13/16 1-1/2 1/32</p>  <p>CHAMPION 1" DOWNEY</p> <p>LASCO #15-9610 FIBER \$</p>	<p>DWGCD # K.R.K.P. PS&amp;P</p> <p>GLL ILL THCK 1-7/8 1-3/4 1/16</p>  <p>PRICE PER 5/8" 34930</p> <p>LASCO #02-1886 NYLON \$</p>	<p>DWGCD # K.R.K.P. PS&amp;P</p> <p>GLL ILL THCK 2 1-3/4 1/32</p>  <p>PRICE PER 5/8" 34930</p> <p>LASCO #02-1884 NYLON \$</p>

02-AW-12

ITEM	DESCRIPTION	QTY.	ITEM	DESCRIPTION	QTY.
------	-------------	------	------	-------------	------

02-1288	#4 Nylon Washer	12	02-1884	#65 Nylon Washer	12
02-1668	#16 Fiber Washer	12	02-1886	#64 Nylon Washer	12
02-1670	#9 Fiber Washer	12	02-1896	#18 Fiber Washer	12
02-1674	#13 Fiber Washer	12	02-1950	#52 Fiber Washer	12
02-1676	#14 Fiber Washer	12	02-1952	#55 Fiber Washer	12
02-1800	#11 Fiber Washer	12	02-1954	#54 Fiber Washer	12
02-1802	#20 Fiber Washer	12	02-7500	#49 Nylon Washer	12
02-1810	#44 Fiber Washer	12	02-7504	#27 Fiber Washer	12
02-1848	#10 Fiber Washer	12	02-7506	#40 Fiber Washer	12
02-1850	#19 Fiber Washer	12	02-7508	#2 Fiber Washer	12
02-1860	#25 Fiber Washer	12	02-7600	#53 Nylon Washer	12
02-1862	#24 Nylon Washer	12	02-7602	#45 Fiber Washer	12
02-1864	#3 Fiber Washer	12	02-7610	#59 Fiber Washer	12
02-1874	#6 Fiber Washer	12	02-7620	#51 Nylon Washer	12
02-1876	#8 Fiber Washer	12	15-9610	#62 Fiber Washer	12
02-1878	#17 Fiber Washer	12	OCD0	Drawer for Cabinet W/32 Holes	1
02-1880	#7 Fiber Washer	12			

03/20/02



































**SEAT ASSORTMENT**

BBAW3 DRAWER

**LASCO**

**LASCO**

 AMERICAN STANDARD 9/16" X 24" AMOUNT: 12	 AMERICAN STANDARD 9/16" X 18" AMOUNT: 12	 KOHLER 1/2" X 27" AMOUNT: 12	 AMERICAN STANDARD 1/2" X 20" AMOUNT: 12	 CRANE 9/16" X 18" AMOUNT: 12	 BRIGGS 9/16" X 20" AMOUNT: 12	 REPCAL (NO-THREADS) 5/8" AMOUNT: 12	 BRIGGS-ROYAL 5/8" X 20" AMOUNT: 12	 PRICE PFISTER 31/32" X 18" AMOUNT: 12	 PRICE PFISTER 1/2" X 20" AMOUNT: 12	 STERLING 1/2" X 24" AMOUNT: 12	 CENTRAL 1/2" X 24" AMOUNT: 12	 MILWAUKEE 33/64" X 27" AMOUNT: 12	 U.R. BURLINGTON 17/32" X 24" AMOUNT: 12	 SAYCO 1/2" X 20" AMOUNT: 12	 SPEAKMAN 7/16" X 27" AMOUNT: 12	 AMERICAN STANDARD 7/16" X 24" AMOUNT: 12	 AMERICAN STANDARD 1/2" X 20" AMOUNT: 12	 GERBER 5/8" X 20" AMOUNT: 12	 KOHLER (NO-THREADS) AMOUNT: 12	 HARCRAFT 9/16" X 20" AMOUNT: 12	 ELJER 1/2" X 20" AMOUNT: 12	 UNION 5/8" X 18" AMOUNT: 12	 STREAMWAY 1/2" X 24" AMOUNT: 12	 AMERICAN STANDARD 7/16" X 24" AMOUNT: 12	 ARROWHEAD 1/2" X 20" AMOUNT: 12	 ARROWHEAD 5/8" X 20" AMOUNT: 12	 REPCAL 9/16" X 28" AMOUNT: 12	 KOHLER 1/2" X 27" AMOUNT: 12	 IMPORT 1/2" X 24" AMOUNT: 12	 PRICE PFISTER 21/32" X 18" AMOUNT: 12	 AMERICAN STANDARD 7/16" X 24" AMOUNT: 12	 DRAWER FOR CABINET W/32 HOLES AMOUNT: 1
---	---	---	--	---	--	--	--	--	--	---	--	--	--	--	--	---	--	---	--	--	--	---	--	---	--	--	--	---	---	--	---	---

ITEM	DESCRIPTION	QTY.	ITEM	DESCRIPTION	QTY.		
X-1	American Standard	9/16 x 24	12	X-58	American Standard	1/2 x 20	12
X-2	American Standard	9/16 x 18	12	X-61	Gerber	5/8 x 20	12
X-6	Kohler	1/2 x 27	12	X-66	Kohler (No-Threads)		12
X-8	American Standard	1/2 x 20	12	X-74	Harcraft	9/16 x 20	12
X-10	Crane	9/16 x 18	12	X-75	Eljer	1/2 x 20	12
X-18	Briggs	9/16 x 20	12	X-76	Union	5/8 x 18	12
X-19	Repcal (No-Threads)	5/8	12	X-77	Streamway	1/2 x 24	12
X-20	Briggs-Royal	5/8 x 20	12	X-79	American Standard	7/16 x 24	12
X-23	Price Pfister	31/32 x 18	12	X-125	Arrowhead	1/2 x 20	12
X-24	Price Pfister	1/2 x 20	12	X-126	Arrowhead	5/8 x 20	12
X-26	Sterling	1/2 x 24	12	X-202	Repcal	9/16 x 28	12
X-32	Central	1/2 x 24	12	X-210	Kohler	1/2 x 27	12
X-39	Milwaukee	33/64 x 27	12	X-215	Import	1/2 x 24	12
X-40	U.R. Burlington	17/32 x 24	12	X-216	Price Pfister	21/32 x 18	12
X-42	Sayco	1/2 x 20	12	X-418	American Standard	7/16 x 24	12
X-45	Speakman	7/16 x 27	12	OCD0	Drawer for Cabinet W/32 Holes		1
X-50	American Standard	7/16 x 24	12				











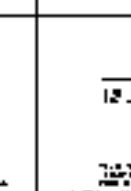
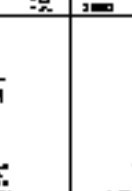
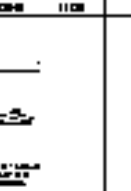
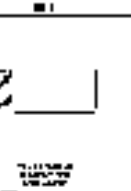
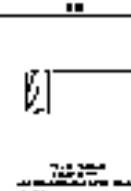
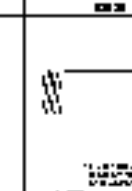
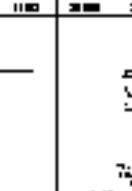
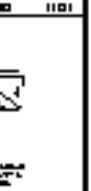

# SEAT ASSORTMENT

BBAW13 DRAWER

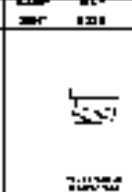
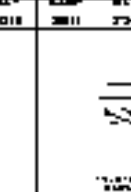
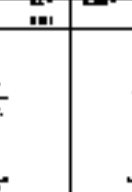
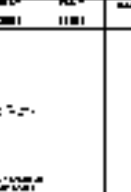
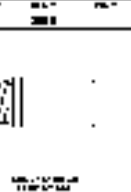
# LASCO

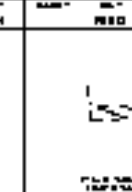
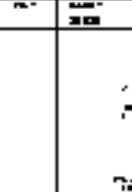
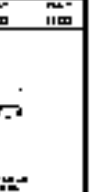
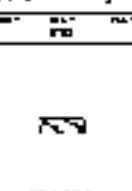
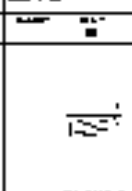
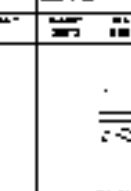
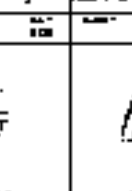
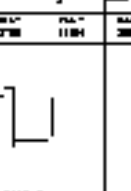
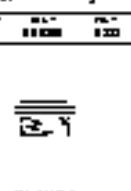
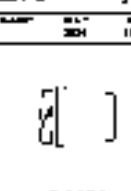
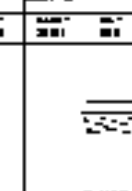
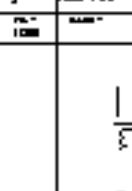
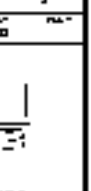
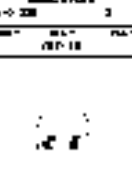
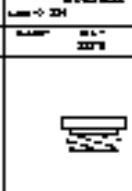
# LASCO

 X-5 Kohler 5/8 x 27 12	 X-7 Kohler 5/8 x 27 12	 X-11 Crane 7/16 x 27 12	 X-12 Crane 9/16 x 22 12	 X-15 Crane 11/16 x 22 12	 X-16 Union Gopher 33/64 x 18 12	 X-17 Briggs 1/2 x 24 12	 X-17L Briggs 1/2 x 20 12	 X-27 Central 5/8 x 24 12	 X-28 Eljer 9/16 x 27 12	 X-29 Eljer 1/2 x 27 12	 X-31 Empire Brass 1/2 x 20 12	 X-34 Speakman 9/16 x 28 12	 X-36 Indiana 1/2 x 27 12	 X-43 Sayco 5/8 x 20 12	 X-48 American Standard 9/16 x 20 12	 X-63 Barnes-Royal 9/16 x 24 12	 X-78 Streamway 1/2 x 24 12	 X-204 Harcraft 3/4 x 20 12	 X-208 Streamway 1/2 x 20 12	 X-217 Union 33/64 x 18 12	 X-218 X-79 Indiana 9/16 x 27 12	 X-220 Briggs 5/8 x 24 12	 X-221 Union 5/8 x 18 12	 X-229 American Brass/Empire 1/2 x 20 12	 X-232 Streamway Renu 1/2 x 20 12	 X-234 Central 9/16 x 27 12	 X-235 Briggs 9/16 x 24 12	 X-237 Gerber (Old Style) 5/8 x 24 12	 X-239 Glauber 5/8 x 20 12	 X-323 Price Pfister (Monel) 21/32 x 18 12	 X-324 Price Pfister (Monel) 1/2 x 24 12	 OCD0 Drawer for Cabinet W/32 Holes 1
--	--	---	---	--	--	---	--	--	---	--	---	--	--	--	--	--	--	--	---	---	---	--	---	---	---	--	---	--	---	--	--	--

































ITEM	DESCRIPTION	QTY.	ITEM	DESCRIPTION	QTY.		
X-5	Kohler	5/8 x 27	12	X-78	Streamway	1/2 x 24	12
x-7	Kohler	5/8 x 27	12	X-204	Harcraft	3/4 x 20	12
X-11	Crane	7/16 x 27	12	X-208	Streamway	1/2 x 20	12
X-12	Crane	9/16 x 22	12	X-217	Union	33/64 x 18	12
X-15	Crane	11/16 x 22	12	X-218	X-79 Indiana	9/16 x 27	12
X-16	Union Gopher	33/64 x 18	12	X-220	Briggs	5/8 x 24	12
X-17	Briggs	1/2 x 24	12	X-221	Union	5/8 x 18	12
X-17L	Briggs	1/2 x 20	12	X-229	American Brass/Empire	1/2 x 20	12
X-27	Central	5/8 x 24	12	X-232	Streamway Renu	1/2 x 20	12
X-28	Eljer	9/16 x 27	12	X-234	Central	9/16 x 27	12
X-29	Eljer	1/2 x 27	12	X-235	Briggs	9/16 x 24	12
X-31	Empire Brass	1/2 x 20	12	X-237	Gerber (Old Style)	5/8 x 24	12
X-34	Speakman	9/16 x 28	12	X-239	Glauber	5/8 x 20	12
X-36	Indiana	1/2 x 27	12	X-323	Price Pfister (Monel)	21/32 x 18	12
X-43	Sayco	5/8 x 20	12	X-324	Price Pfister (Monel)	1/2 x 24	12
X-48	American Standard	9/16 x 20	12	OCD0	Drawer for Cabinet W/32 Holes		1
X-63	Barnes-Royal	9/16 x 24	12				

# CONE WASHER ASSORTMENT

BBAW4 DRAWER

# LASCO

# LASCO

 #1 3/8" x 1/2" x 3/32" 3	 #2 3/8" x 3/4" x 3/32" 3	 #3 3/8" x 3/4" x 3/32" 3	 #4 3/8" x 3/4" x 3/32" 3	 #5 3/8" x 3/4" x 3/32" 3	 #6 3/8" x 3/4" x 3/32" 3	 #7 3/8" x 3/4" x 3/32" 3	 #8 3/8" x 3/4" x 3/32" 3
 #9 3/8" x 3/4" x 3/32" 3	 #10 3/8" x 3/4" x 3/32" 3	 #11 3/8" x 3/4" x 3/32" 3	 #12 3/8" x 3/4" x 3/32" 3	 #13 3/8" x 3/4" x 3/32" 3	 #14 3/8" x 3/4" x 3/32" 3	 #15 3/8" x 3/4" x 3/32" 3	 #16 3/8" x 3/4" x 3/32" 3
 #17 3/8" x 3/4" x 3/32" 3	 #18 3/8" x 3/4" x 3/32" 3	 #19 3/8" x 3/4" x 3/32" 3	 #20 3/8" x 3/4" x 3/32" 3	 #21 3/8" x 3/4" x 3/32" 3	 #22 3/8" x 3/4" x 3/32" 3	 #23 3/8" x 3/4" x 3/32" 3	 #24 3/8" x 3/4" x 3/32" 3
 #25 3/8" x 3/4" x 3/32" 3	 #26 3/8" x 3/4" x 3/32" 3	 #27 3/8" x 3/4" x 3/32" 3	 #28 3/8" x 3/4" x 3/32" 3	 #29 3/8" x 3/4" x 3/32" 3	 #30 3/8" x 3/4" x 3/32" 3	 #31 3/8" x 3/4" x 3/32" 3	 #32 3/8" x 3/4" x 3/32" 3

ITEM	DESCRIPTION	QTY.	ITEM	DESCRIPTION	QTY.
02-1660	#4 Brass Ring	24	02-2228	#10 Cone Washer	24
02-1662	#6 Brass Ring	24	02-2240	#16 Cone Washer	24
02-1672	#3 Brass Ring	24	02-2242	#17 Cone Washer	24
02-2200	#1 Cone Washer	24	02-2244	#18 Cone Washer	24
02-2202	#2 Cone Washer	24	02-2300	#B Brass Friction Ring	24
02-2204	#3 Cone Washer	24	02-2302	#C Brass Friction Ring	24
02-2206	#5 Cone Washer	24	02-2304	#D Brass Friction Ring	24
02-2208	#7 Cone Washer	24	02-2306	#F Brass Friction Ring	24
02-2210	#6 Cone Washer	24	02-2308	#G Brass Friction Ring	24
02-2212	#11 Cone Washer	24	02-2310	#11 Brass Ring	24
02-2214	#12 Cone Washer	24	02-2312	#12 Brass Ring	24
02-2216	#14 Cone Washer	24	02-2314	#14 Brass Ring	24
02-2218	#13 Cone Washer	24	02-2322	#H Brass Friction Ring	24
02-2220	#8 Cone Washer	24	02-2326	#A Brass Friction Ring	24
02-2222	#15 Cone Washer	24	02-2328	#E Brass Friction Ring	24
02-2224	#9 Cone Washer	24	0CD0	Drawer for Cabinet W/32 Holes	1
02-2226	#4 Cone Washer	24			









































# O'RING ASSORTMENT

BBAW5 DRAWER

# LASCO

# LASCO

 #1 1 1/4 x 1/4 x 1/8 3	 #2 1 1/2 x 1/4 x 1/8 3	 #3 1 3/4 x 1/4 x 1/8 3	 #4 1 7/8 x 1/4 x 1/8 3	 #5 2 x 1/4 x 1/8 3	 #6 2 1/4 x 1/4 x 1/8 3	 #7 2 3/4 x 1/4 x 1/8 3	 #8 3 x 1/4 x 1/8 3	 #9 3 1/2 x 1/4 x 1/8 3
 #10 2 1/4 x 3/8 x 1/8 3	 #11 2 3/4 x 3/8 x 1/8 3	 #12 3 x 3/8 x 1/8 3	 #13 3 1/4 x 3/8 x 1/8 3	 #14 3 3/4 x 3/8 x 1/8 3	 #15 4 x 3/8 x 1/8 3	 #16 4 1/4 x 3/8 x 1/8 3	 #17 4 3/4 x 3/8 x 1/8 3	 #18 5 x 3/8 x 1/8 3
 #19 3 1/4 x 1/2 x 1/8 3	 #20 3 3/4 x 1/2 x 1/8 3	 #21 4 x 1/2 x 1/8 3	 #22 4 1/4 x 1/2 x 1/8 3	 #23 4 3/4 x 1/2 x 1/8 3	 #24 5 x 1/2 x 1/8 3	 #25 5 1/4 x 1/2 x 1/8 3	 #26 5 3/4 x 1/2 x 1/8 3	 #27 6 x 1/2 x 1/8 3
 #28 3 1/4 x 3/4 x 1/8 3	 #29 3 3/4 x 3/4 x 1/8 3	 #30 4 x 3/4 x 1/8 3	 #31 4 1/4 x 3/4 x 1/8 3	 #32 4 3/4 x 3/4 x 1/8 3	 #33 5 x 3/4 x 1/8 3	 #34 5 1/4 x 3/4 x 1/8 3	 #35 5 3/4 x 3/4 x 1/8 3	 #36 6 x 3/4 x 1/8 3

ITEM	DESCRIPTION	QTY.	ITEM	DESCRIPTION	QTY.
02-1414	#27 9/16 x 11/16 x 1/16	24	02-1532	#48 7/8 x 1-1/8 x 1/8	24
02-1450	#6 1/4 x 7/16 x 3/32	24	02-1534	#15 3/8 x 1/2 x 1/16	24
02-1454	#9 5/16 x 1/2 x 3/32	24	02-1538	#40 3/4 x 7/8 x 1/16	24
02-1504	#21 1/2 x 5/8 x 1/16	R-42 24	02-1548	#24 33/64 x 5/8 x 1/16	24
02-1506	#22 1/2 x 11/16 x 3/32	R-43 24	02-1552	#10 5/16 x 9/16 x 1/8	24
02-1508	#8 5/16 x 7/16 x 1/16	R-44 24	02-1556	#18 7/16 x 9/16 x 1/16	24
02-1510	#42 3/4 x 1 x 1/8	R-45 24	02-1560	#17 3/8 x 5/8 x 1/8	24
02-1512	#5 1/4 x 3/8 x 1/16	R-46 24	02-1562	#30 5/8 x 3/4 x 1/16	24
02-1514	#19 7/16 x 5/8 x 3/32	R-47 24	02-1566	#51 15/16 x 1-3/16 x 1/8	24
02-1516	#28 9/16 x 3/4 x 3/32	R-48 24	02-1578	#3 3/16 x 5/16 x 1/16	24
02-1518	#38 11/16 x 7/8 x 3/32	24	02-1580	#37 1/16 x 13/16 x 1/16	24
02-1520	#16 3/8 x 9/32 x 3/32	R-50 24	02-1586	#65 1-3/16 x 1-3/8 x 3/32	24
02-1522	#31 5/8 x 13/16 x 3/32	R-51 24	02-1624	#1 1/8 x 1/4 x 1/16	24
02-1524	#41 3/4 x 15/16 x 3/32	R-52 24	02-1626	#2 5/32 x 9/32 x 1/16	24
02-1526	#45 13/16 x 1-1/16 x 1/8	R-53 24	02-1628	#4 7/32 x 11/32 x 1/16	24
02-1528	#47 7/8 x 1-1/16 x 3/32	R-54 24	OCD0	Drawer for Cabinet W/32 Holes	1
02-1530	#20 7/16 x 11/16 x 1/8	R-55 24			

# O'RING ASSORTMENT

BBAW15 DRAWER



ITEM	DESCRIPTION	QTY.	ITEM	DESCRIPTION	QTY.
02-1632	#36 41/64 x 51/64 x 5/64	12	02-1544	#58 1-1/16 x 1-3/16 x 1/16	12
02-1630	#52 31/32 x 1-3/32 x 1/16	12	02-1542	#71 1-5/16 x 1-1/2 x 3/32	12
02-1596	#44 13/16 x 1 x 3/32	12	02-1536	#63 1-1/8 x 1-3/8 x 1/8	12
02-1594	#77 1-7/16 x 1-5/8 x 3/32	12	R-81		
02-1590	#93 1-3/4 x 1-15/16 x 3/32	12	02-1492	#98 1-7/8 x 2-1/8 x 1/8	12
02-1584	#83 1-9/16 x 1-3/4 x 3/32	12	02-1488	#87 1-5/8 x 1-7/8 x 1/8	12
02-1582	#12 METRIC .350 x .106	12	02-1484	#60 1-1/16 x 1-5/16 x 1/8	12
02-1576	#43 13/16 x 15/16 x 1/16	12	R-78		
02-1574	#103 2 x 2-3/16 x 3/32	12	R-77		
02-1572	#85 1-5/8 x 1-3/4 x 1/16	12	R-76		
02-1570	#69 1-1/4 x 1-1/2 x 1/8	12	R-75		
02-1568	#61 1-1/8 x 1-1/4 x 1/16	12	R-74		
02-1564	#50 15/16 x 1-1/8 x 3/32	12	R-72		
02-1558	#46 7/8 x 1 x 1/16	12	R-69		
02-1554	#72 1-5/16 x 1-9/16 x 1/8	12	R-67		
02-1550	#49 15/16 x 1-1/16 x 1/16	12	R-65		
02-1546	#56 1 x 1-3/16 x 3/32	12	R-63		
			02-1454	#95 1-3/4 x 2-1/8 x 3/16	12
			02-1466	#95 1-3/4 x 2-1/8 x 3/16	12
			02-1464	#88 1-5/8 x 2 x 3/16	12
			02-1458	#62 1-1/8 x 1-5/16 x 3/32	12
			02-1438	#92 1-3/4 x 1-7/8 x 1/16	12
			02-1432	#73 1-3/8 x 1-1/2 x 1/16	12
			02-1424	#64 1-3/16 x 1-5/16 x 1/16	12
			02-1404	#13 23/64 x 37/64 x 7/64	12
			0CD0	Drawer for Cabinet W/32 Holes	1



# HANDLE & BIBB SCREW ASSORTMENT

BBAW6 DRAWER

**LASCO**

**LASCO**

ITEM	DESCRIPTION	QTY.	ITEM	DESCRIPTION	QTY.
XS-1258	3/8 x 10-24 Locking Screw	12	XS-520P	1-1/2 x 10-24 Oval PB Cut-Off Screw	12
XS-500	1/2 x 8-32 CP Handle Screw	12	XS-530CP	1-1/2 x 8-32 Oval CP Cut-Off Screw	12
XS-501	1/2 x 10-24 CP Handle Screw	12	XS-530P	1-1/2 x 8-32 Oval PB Cut-Off Screw	12
XS-502	1/2 x 8-32 CP Handle Screw	12	XS-531	1-1/4 x 8-32 Flat Head Handle Screw	12
XS-503	7/8 x 8-32 CP Handle Screw	12	XS-550	1/4 x 8-32 Brass Bibb Screw	12
XS-504	3/8 x 8-32 CP Handle Screw	12	XS-552	1/2 x 8-32 Brass Bibb Screw S-6	12
XS-505	3/8 x 8-32 CP Handle Screw	12	XS-553	3/8 x 10-24 Brass Bibb Screw S-9	12
XS-506	1/2 x 10-24 Oval CP Handle Screw	12	XS-554	1/2 x 10-24 Brass Bibb Screw S-5	12
XS-507	7/8 x 10-24 CP Handle Screw	12	XS-555	3/8 x 8-32 Brass Bibb Screw S-8	12
XS-508	9/16 x 8-32 CP Handle Screw	12	XS-556	3/8 x 10-28 Brass Bibb Screw	12
XS-509	11/32 x 10-32 CP Handle Screw	12	XS-557	1/2 x 10-28 Brass Bibb Screw	12
XS-512	7/8 x 10-24 CP Handle Screw	12	XS-558	3/8 x 10-32 Brass Bibb Screw S-7	12
XS-513	1-1/4 x 10-24 CP Handle Screw	12	XS-559	1/2 x 10-32 Brass Bibb Screw S-4	12
XS-514	1-1/2 x 10-24 CP Handle Screw	12	XS-560	3/8 x 6-32 Brass Bibb Screw S-3	12
XS-515	1-1/2 x 10-24 Oval CP Handle Screw	12	XS-561	1/2 x 6-32 Brass Bibb Screw	12
XS-516	3 x 10-24 Chrome Handle Screw	12	OCD0	Drawer for Cabinet W/32 Holes	1
XS-520CP	1-1/2 x 10-24 Oval CP Cut-Off Screw	12			



# SQUARE CUT PACKING ASSORTMENT

BBAW7 DRAWER

LASCO

LASCO

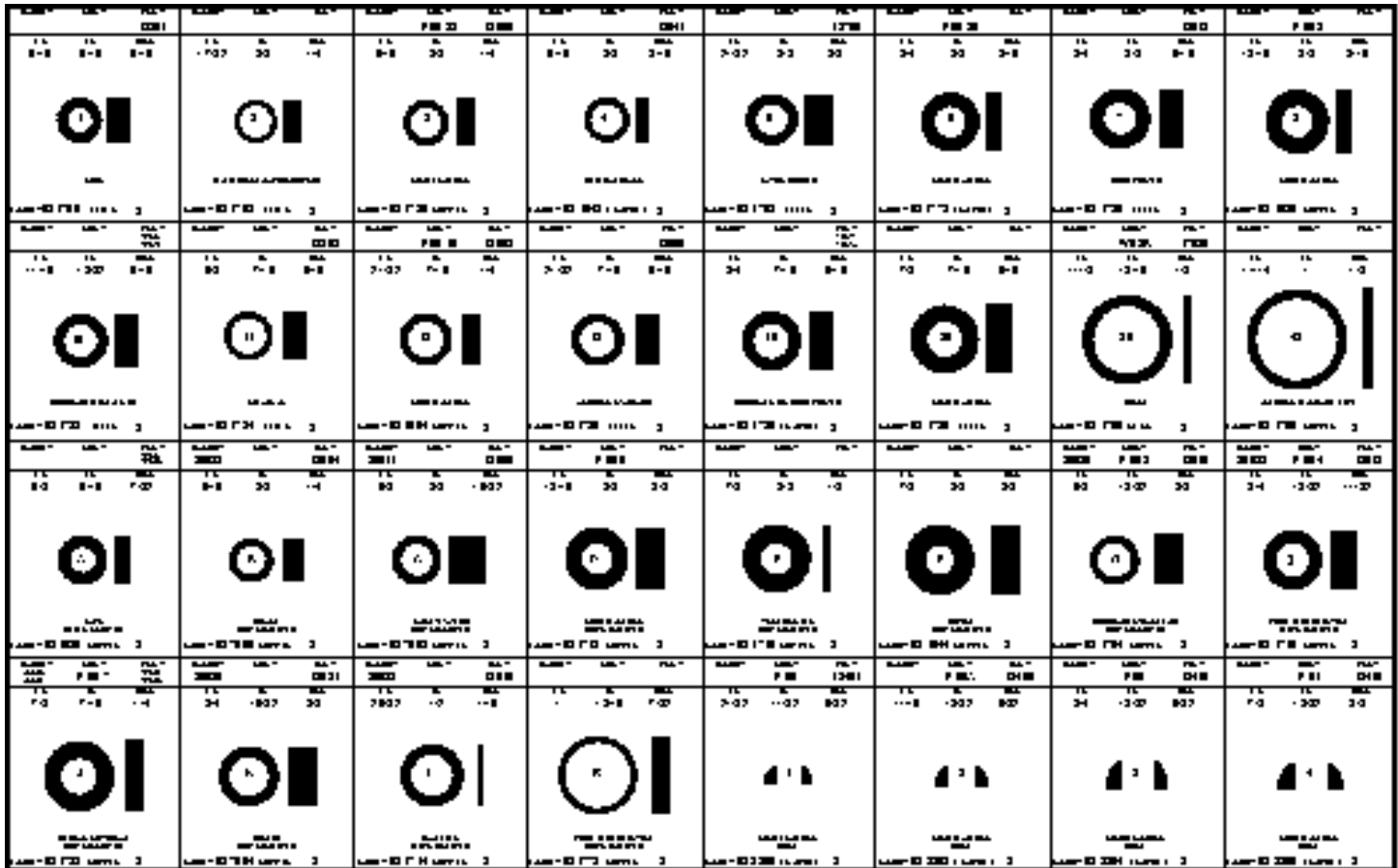

ITEM	DESCRIPTION	QTY.	ITEM	DESCRIPTION	QTY.		
02-1636	Stem PK 5/16 x 5/8 x 7/32	#A	12	02-1730	SQ Cut 7/16 x 3/4 x 5/16	#16	12
02-1644	Stem PK 3/8 x 7/8 x 3/8	#F	12	02-1732	SQ Cut 7/16 x 7/8 x 1/4	#J	12
02-1648	SQ Cut 3/8 x 9/16 x 3/16	#4	12	02-1736	SQ Cut 7/16 x 7/8 x 1/8	#20	12
02-1680	Molded PK 3/8 x 13/16 x 3/16	#8	12	02-1760	Cork 13/16 x 1-1/8 x 1/8	#39	12
02-1694	Duck Type 7/16 x 21/32 x 1/4	#12	12	02-1772	Graphite 3/8 x 3/4 x 3/16	#6	12
02-1700	SQ Cut 5/16 x 9/16 x 5/16	#1	12	02-1778	SQ Cut 1/16 x 1 x 7/32	#R	12
02-1702	SQ Cut 3/8 x 17/32 x 1/4	#2	12	02-1786	SQ Cut 3/8 x 9/16 x 1/4	#3	12
02-1704	SQ Cut 13/32 x 5/8 x 3/8	#G	12	02-1790	A/S PK 1 x 1-1/4 x 1/8	#42	12
02-1708	SQ Cut 3/8 x 21/32 x 3/8	#5	12	02-2350	Cone PK 11/32 x 21/32 x 9/32	#1	12
02-1710	SQ Cut 13/32 x 3/4 x 5/16	#1	12	02-2352	Cone PK 11/32 x 11/16 x 9/32	#2	12
02-1712	SQ Cut 3/8 x 13/16 x 3/8	#D	12	02-2354	Cone PK 11/32 x 3/4 x 9/32	#3	12
02-1714	SQ Cut 1/2 x 25/32 x 1/16	#L	12	02-2356	Cone PK 11/32 x 7/8 x 3/8	#4	12
02-1716	SQ Cut 3/8 x 7/8 x 1/8	#E	12	02-7000	SQ Cut 3/8 x 9/16 x 1/4	#B	12
02-1720	SQ Cut 3/8 x 3/4 x 5/16	#7	12	02-7002	SQ Cut 3/8 x 5/8 x 1/4	#2	12
02-1722	SQ Cut 13/32 x 11/16 x 5/16	#10	12	02-7004	SQ Cut 15/32 x 3/4 x 3/8	#K	12
02-1724	SQ Cut 7/16 x 5/8 x 5/16	#11	12	0CD0	Drawer for Cabinet W/32 Holes		1
02-1726	SQ Cut 7/16 x 32/32 x 5/16	#13	12				



# SQUARE CUT PACKING ASSORTMENT

BBAW17 DRAWER

# LASCO

# LASCO

DAWCO P K.R.P. P.S.M.P. 12606 G.L. I.L. I.T.R.K. 9/16 13/32 3/8  BRKDS LASCO # 02-1718 TEFLON \$	DAWCO P K.R.P. P.S.M.P. 12746 G.L. I.L. I.T.R.K. 11/16 7/16 1/4  PRICE PK 5/8 2B&B LASCO # 02-7010 RUBBER \$	DAWCO P K.R.P. P.S.M.P. 12746 G.L. I.L. I.T.R.K. 11/16 7/16 5/16  LOGAN LASCO # 02-1728 TEFLON \$	DAWCO P K.R.P. P.S.M.P. 12512 G.L. I.L. I.T.R.K. 25/32 7/16 1/4  MISCELLANEOUS LASCO # 02-1734 TEFLON \$	DAWCO P K.R.P. P.S.M.P. 12518 G.L. I.L. I.T.R.K. 5/8 15/32 5/16  PRICE PK 5/8 LASCO # 02-1640 GRAPHITE \$	DAWCO P K.R.P. P.S.M.P. 12711 G.L. I.L. I.T.R.K. 7/8 15/32 5/16  BEPCAL LASCO # 02-1738 GRAPHITE \$	DAWCO P K.R.P. P.S.M.P. 12711 G.L. I.L. I.T.R.K. 13/16 1/2 5/16  KOHLER LASCO # 02-1742 TEFLON \$	DAWCO P K.R.P. P.S.M.P. 12711 G.L. I.L. I.T.R.K. 29/32 1/2 15/32  MISCELLANEOUS LASCO # 02-1746 TEFLON \$
DAWCO P K.R.P. P.S.M.P. 12515 G.L. I.L. I.T.R.K. 25/32 19/32 11/32  AMERICAN STANDARD LASCO # 02-1744 TEFLON \$	DAWCO P K.R.P. P.S.M.P. 12515 G.L. I.L. I.T.R.K. 29/32 19/32 1/2  AMERICAN STANDARD LASCO # 02-7012 RUBBER \$	DAWCO P K.R.P. P.S.M.P. P-99-13 G.L. I.L. I.T.R.K. 3/4 5/8 3/8  MISCELLANEOUS LASCO # 02-1690 RUBBER \$	DAWCO P K.R.P. P.S.M.P. P-99-14 G.L. I.L. I.T.R.K. 27/32 5/8 7/32  AMERICAN STANDARD LASCO # 02-1692 RUBBER \$	DAWCO P K.R.P. P.S.M.P. P-99-10 G.L. I.L. I.T.R.K. 7/8 5/8 1/4  MISCELLANEOUS LASCO # 02-1684 GRAPHITE \$	DAWCO P K.R.P. P.S.M.P. P-99-19 G.L. I.L. I.T.R.K. 7/8 11/16 5/16  MISCELLANEOUS LASCO # 02-1770 GRAPHITE \$	DAWCO P K.R.P. P.S.M.P. 17642 G.L. I.L. I.T.R.K. 7/8 11/16 1/16  KOHLER LASCO # 02-7006 CORK \$	DAWCO P K.R.P. P.S.M.P. P-98-7 G.L. I.L. I.T.R.K. 7/8 11/16 3/16  MISCELLANEOUS LASCO # 02-1652 GRAPHITE \$
DAWCO P K.R.P. P.S.M.P. P-99-16 G.L. I.L. I.T.R.K. 7/8 3/4 5/16  MISCELLANEOUS LASCO # 02-1696 TEFLON \$	DAWCO P K.R.P. P.S.M.P. P-99-17 G.L. I.L. I.T.R.K. 7/8 3/4 5/16  CHICAGO SPIRIT LASCO # 02-1782 RUBBER \$	DAWCO P K.R.P. P.S.M.P. P-99-11 G.L. I.L. I.T.R.K. 15/16 3/4 3/8  MISCELLANEOUS LASCO # 02-1686 GRAPHITE \$	DAWCO P K.R.P. P.S.M.P. P-99-12 G.L. I.L. I.T.R.K. 1 3/4 1/4  MISCELLANEOUS LASCO # 02-1688 GRAPHITE \$	DAWCO P K.R.P. P.S.M.P. P-99-21 G.L. I.L. I.T.R.K. 1-1/16 25/32 7/32  MISCELLANEOUS LASCO # 02-1774 GRAPHITE \$	DAWCO P K.R.P. P.S.M.P. 17777 G.L. I.L. I.T.R.K. 1-1/16 13/16 1/16  CHICAGO LASCO # 02-7008 CORK \$	DAWCO P K.R.P. P.S.M.P. P-98-15 G.L. I.L. I.T.R.K. 27/32 21/32 13/32  MISCELLANEOUS LASCO # 02-1666 GRAPHITE \$	DAWCO P K.R.P. P.S.M.P. P-98-6 G.L. I.L. I.T.R.K. 1-5/32 7/8 3/16  MISCELLANEOUS LASCO # 02-1650 GRAPHITE \$
DAWCO P K.R.P. P.S.M.P. 36629 G.L. I.L. I.T.R.K. 11/16 13/32 1/4  BEPCAL CLOTH LASCO # 02-1706 RUBBER \$	DAWCO P K.R.P. P.S.M.P. P-99-17 G.L. I.L. I.T.R.K. 29/32 1/2 11/32  MISCELLANEOUS LASCO # 02-1698 RUBBER \$	DAWCO P K.R.P. P.S.M.P. P-84 G.L. I.L. I.T.R.K. 7/8 9/16 1/4  MISCELLANEOUS LASCO # 02-1740 RUBBER \$	DAWCO P K.R.P. P.S.M.P. P-99-22 G.L. I.L. I.T.R.K. 31/32 5/8 1/4  MISCELLANEOUS LASCO # 02-1776 RUBBER \$	DAWCO P K.R.P. P.S.M.P. P-99-9 G.L. I.L. I.T.R.K. 1 5/8 1/8  MISCELLANEOUS LASCO # 02-1682 RUBBER \$	DAWCO P K.R.P. P.S.M.P. P-99-18 G.L. I.L. I.T.R.K. 31/32 11/16 3/8  MISCELLANEOUS LASCO # 02-1768 RUBBER \$	DAWCO P K.R.P. P.S.M.P. P-99-24 G.L. I.L. I.T.R.K. 1 13/16 1/4  MISCELLANEOUS LASCO # 02-1788 RUBBER \$	DAWCO P K.R.P. P.S.M.P. P-62 G.L. I.L. I.T.R.K. 15/16 1/2 3/8  MISCELLANEOUS LASCO # 02-2358 GRAPHITE \$











ITEM	DESCRIPTION	QTY.	ITEM	DESCRIPTION	QTY.		
02-1640	Stem PK 15/32 x 5/8 x 5/16	#21	12	02-1740	SQ Cut 9/16 x 7/8 x 1/4	#N	12
02-1650	Split PK 7/8 x 1-5/32 x 3/16	#41	12	02-1742	SQ Cut 1/2 x 13/16 x 5/16	#23	12
02-1652	Split PK 11/16 x 7/8 x 3/16	#32	12	02-1744	SQ Cut 19/32 x 25/32 x 11/32	#25	12
02-1666	Split PK 7/8 x 1 x 1/4	#40	12	02-1746	SQ Cut 1/2 x 29/32 x 15/32	#24	12
02-1682	SQ Cut 5/8 x 1 x 1/8	#P	12	02-1768	SQ Cut 11/16 x 31/32 x 3/8	#Q	12
02-1684	Graphite 5/8 x 7/8 x 1/4	#29	12	02-1770	SQ Cut 11/16 x 7/8 x 5/16	#30	12
02-1686	Graphite 3/4 x 15/16 x 3/8	#35	12	02-1774	SQ Cut 25/32 x 1-1/16 x 7/32	#37	12
02-1688	Graphite 3/4 x 1 x 1/4	#36	12	02-1776	SQ Cut 5/8 x 31/32 x 1/4	#O	12
02-1690	Duck Type 5/8 x 3/4 x 9/32	#27	12	02-1782	SQ Cut 3/4 x 7/8 x 5/16	#34	12
02-1692	Duck Type 5/8 x 27/32 x 7/32	#28	12	02-1788	SQ Cut 13/16 x 1 x 1/4	#S	12
02-1696	SQ Cut 3/4 x 7/8 x 5/16	#33	12	02-2358	Cone PK 1/2 x 15/16 x 3/8	#5	12
02-1698	SQ Cut 1/2 x 29/32 x 11/32	#M	12	02-7006	SQ Cut 11/16 x 7/8 x 1/16	#31	12
02-1706	SQ Cut 13/32 x 11/16 x 3/16	#H	12	02-7008	SQ Cut 13/16 x 1-1/16 x 1/16	#38	12
02-1718	SQ Cut 13/32 x 9/16 x 3/8	#9	12	02-7010	SQ Cut 7/16 x 11/16 x 1/4	#14	12
02-1728	SQ Cut 7/16 x 11/16 x 5/16	#15	12	02-7012	SQ Cut 19/32 x 29/32 x 1/2	#26	12
02-1734	SQ Cut 7/16 x 25/32 x 1/4	#19	12	0CD0	Drawer for Cabinet W/32 Holes		1
02-1738	SQ Cut 15/32 x 7/8 x 5/16	#22	12				

MISCELLANEOUS ASSORTMENT

BBAW8 DRAWER

LASCO

LASCO

 KOHLER DIVERTER WASHER PART # 02-1282 QTY 12	 KOHLER DIVERTER BALL WASHER PART # 02-1284 QTY 12	 UR DIVERTER WASHER PART # 02-1286 QTY 12	 ELJER DIVERTER WASHER PART # 02-1290 QTY 12	 PRICE PFISTER M/H DIVERTER SEAT WASHER PART # 02-1752 QTY 12	 WASHERLESS CARTRIDGE WASHER PART # 02-1784 QTY 12	 #22303 BRIGGS WASHER PART # 02-1792 QTY 12	 W-46 AMERICAN STANDARD WASHER PART # 02-1794 QTY 12	 AMERICAN STANDARD CADET STEM WASHER PART # 02-1798 QTY 12	 AMERICAN STANDARD COLONY PACKING PART # 02-1882 QTY 12	 W-55 RUBBER WASHER PART # 02-1888 QTY 12	 STERLING/GERBER DIVERTER WASHER PART # 02-1898 QTY 12	 GERBER WASHERLESS CARTRIDGE WASHER PART # 02-1900 QTY 12	 CENTRAL BRASS DIVERTER WASHER PART # 02-1904 QTY 12	 W-38 RUBBER BALLCOCK WASHER PART # 02-2906 QTY 12	 PRICE PFISTER CERAMIC SHOWER STEM SEAL PART # 02-7510 QTY 12	 K-55-1 DELTA NEW STYLE SEAT PART # 0-3000-1 QTY 12	 DELTA OLD STYLE SEAT PART # 0-3000-2 QTY 12	 DELTA OLD STYLE SPRING PART # 0-3000-3 QTY 12	 DELTA K-55-2 NEW STYLE SPRING PART # 0-3000-4 QTY 12	 DELTA #55-2 NEW STYLE SPRING PART # 0-3000-5 QTY 12	 DELTA #61 CAM ONLY PART # 0-3000-6 QTY 12	 DELTA #188 CAM ONLY PART # 0-3000-7 QTY 12	 DELTA CAM PACKING ONLY PART # 0-3000-8 QTY 12	 VALLEY SEAT ONLY PART # 0-3080-1 QTY 12	 VALLEY SEAT SPRING ONLY PART # 0-3080-2 QTY 12	 UR MILWAUKEE SEAT PART # 0-3090-1 QTY 12	 UR MILWAUKEE SPRING PART # 0-3090-2 QTY 12	 BRADTRIL REPLACEMENT SEAT PART # 0-3092-1 QTY 12	 NIBCO SEAT SEAL PART # 0-4190-1 QTY 12	 NIBCO SEAT SPRING PART # 0-4190-2 QTY 12	 AMERICAN STANDARD CARTRIDGE SEAL KIT PART # AS57583-07 QTY 12	 AMERICAN STANDARD WAVE WASHER PART # AS72852-07 QTY 12	 DRAWER FOR CABINET W/32 HOLES PART # 0CD0 QTY 1
---	--	---	--	---	---	---	--	--	---	---	--	---	--	--	---	---	--	--	---	--	--	---	--	--	---	---	---	---	---	---	--	---	--

ITEM	DESCRIPTION	QTY.	ITEM	DESCRIPTION	QTY.
------	-------------	------	------	-------------	------

02-1282	Kohler Diverter Washer	12	0-3000-2	Delta Old Style Seat	12
02-1284	Kohler Diverter Ball Washer	12	0-3000-3	Delta Old Style Spring	12
02-1286	UR Diverter Washer	12	0-3000-4	Delta K-55-2 New Style Spring	12
02-1290	Eljer Diverter Washer	12	0-3000-5	Delta #61 Cam Only	12
02-1752	Price Pfister M/H Diverter Seat Washer	12	0-3000-6	Delta #188 Cam Only	12
02-1784	Washerless Cartridge Washer	12	0-3000-7	Delta Cam Packing Only	12
02-1792	#22303 Briggs Washer	12	0-3080-1	Valley Seat Only	12
02-1794	W-46 American Standard Washer	12	0-3080-2	Valley Seat Spring Only	12
02-1798	American Standard Cadet Stem Washer	12	0-3090-1	UR Milwaukee Seat	12
02-1882	American Standard Colony Packing	12	0-3090-2	UR Milwaukee Spring	12
02-1888	W-55 Rubber Washer	12	0-3092-1	Bradtril Replacement Seat	12
02-1898	Sterling/Gerber Diverter Washer	12	0-4190-1	Nibco Seat Seal	12
02-1900	Gerber Washerless Cartridge Washer	12	0-4190-2	Nibco Seat Spring	12
02-1904	Central Brass Diverter Washer	12	AS57583-07	American Standard Cartridge Seal Kit	12
02-2906	W-38 Rubber Ballcock Washer	12	AS72852-07	American Standard Wave Washer	12
02-7510	Price Pfister Ceramic Shower Stem Seal	12	0CD0	Drawer for Cabinet W/32 Holes	1
0-3000-1	K-55-1 Delta New Style Seat	12			





# FITTING WASHER ASSORTMENT

BBAW9 DRAWER

LASCO

LASCO

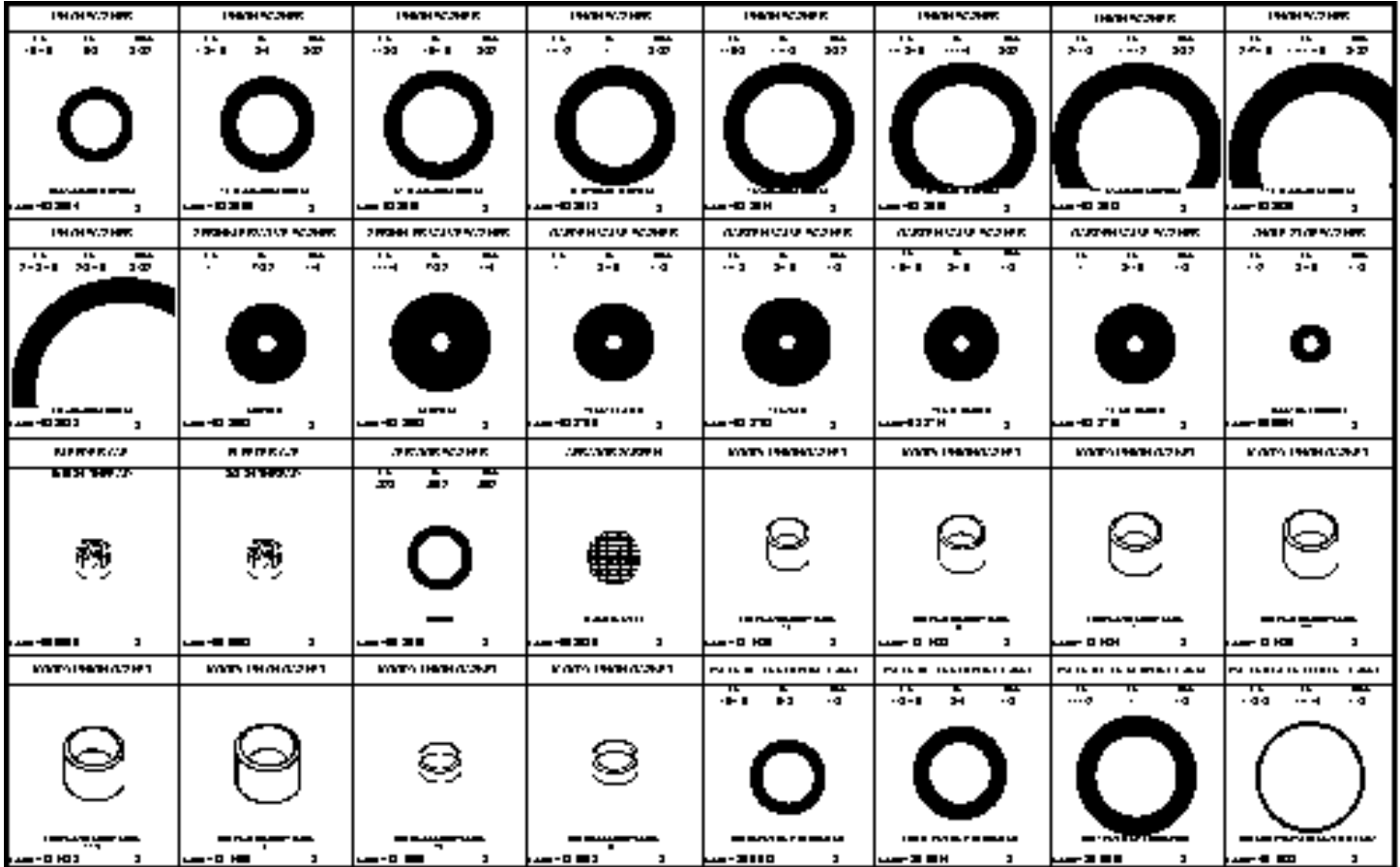

ITEM	DESCRIPTION	QTY.	ITEM	DESCRIPTION	QTY.
02-2004	W-472 Union Washer	12	06-9058	Bleeder Cap 3/8-24 Arrowhead	12
02-2006	W-473 Union Washer	12	09-2010	6248 Aerator Snap Nipple Washer	12
02-2010	W-474 Union Washer	12	09-2026	Bulk Aerator Screens	12
02-2012	W-475 Union Washer	12	13-1480	1/2 Moody Gasket	12
02-2014	W-476 Union Washer	12	13-1482	3/4 Moody Gasket	12
02-2016	W-476A Union Washer	12	13-1484	1 Moody Gasket	12
02-2018	W-477 Union Washer	12	13-1486	1-1/4 Moody Gasket	12
02-2020	W-478 Union Washer	12	13-1488	1-1/2 Moody Gasket	12
02-2022	W-479 Union Washer	12	13-1490	2 Moody Gasket	12
02-2662	W-60 Sprinkler Valve Washer	12	13-1550	1/2 Moody Union Washer	12
02-2668	W-61 Sprinkler Valve Washer	12	13-1552	3/4 Moody Union Washer	12
02-2700	W-220 Garden Valve Washer	12	26-9012	5/8 Water Meter Coupling Washer	12
02-2702	W-221 Garden Valve Washer	12	26-9014	3/4 Water Meter Coupling Washer	12
02-2714	W-220AS Garden Valve Washer	12	26-9016	1 Water Meter Coupling Washer	12
02-2716	W-220A Garden Valve Washer	12	40-1532	Screw-In Heater Element Gasket	12
06-9054	Angle Stop Push On Washer	12	OCD0	Drawer for Cabinet W/32 Holes	1
06-9056	Bleeder Cap 5/16-24 #2	12			

**BUTTON ASSORTMENT**

BBAW41 DRAWER



ITEM	DESCRIPTION	QTY.	ITEM	DESCRIPTION	QTY.
0-8070	PP941-070A Hot Marquis Button	6	0-8742	Cold 1-1/16" O.D. Gerber Button	6
0-8072	PP941-060A Cold Marquis Button	6	0-8866	Hot Smoked Lasco Button	6
0-8074	PP941-080A Diverter Marquis Button	6	0-8868	Cold Smoked Lasco Button	6
0-8150	PP941-330A Hot Button	6	0-8870	Diverter Smoked Lasco Button	6
0-8152	PP941-320A Cold Button	6	0-8894	Hot 1-5/16" O.D. Delta Button	6
0-8154	PP941-340A Diverter Button	6	0-8896	Cold 1-5/16" O.D. Delta Button	6
0-8180	Hot Crown Imperial Button	6	0-8900	Single Lever 1-5/16" O.D. Delta Button	6
0-8182	Cold Crown Imperial Button	6	0-8930	Moen Silver/Black Button	6
0-8184	Diverter Crown Imperial Button	6	0-8938	Moen Teardrop Button	6
0-8520	Hot Old Style Delex Button	6	0-8940	PP Deep Avante Button Clear	6
0-8522	Cold Old Style Delex Button	6	0-8942	PP Deep Avante Button Smoked	6
0-8600	PP941-330 Hot Button	6	0-8946	Price Pfister Button	6
0-8602	PP941-320 Cold Button	6	0-8990	Hot Delta Wave Button	6
0-8604	PP941-340 Diverter Button	6	0-8992	Cold Delta Wave Button	6
0-8630	Hot 1" O.D. Valley Button	6	0-8994	Single Lever Delta Wave Button	6
0-8632	Cold 1" O.D. Valley Button	6	0CDO	Drawer for Cabinet W/32 Holes	1
0-8740	Hot 1-1/16" O.D. Gerber Button	6			



# BUTTON ASSORTMENT

BBAW42 DRAWER

# LASCO

# LASCO

<p>PNL</p> <p>1/2" 1/2" 3/8" P14H</p> <p>0-8000 3</p>	<p>2 1/2" O.D.</p> <p>1/2" 1/2" 3/8" HEP</p> <p>0-8020 3</p>	<p>2 1/2" O.D.</p> <p>1/2" 1/2" 3/8" CSD</p> <p>0-8022 3</p>	<p>PP NEW WINDSOR</p> <p>3/8" 3/8" 1/2" HEP</p> <p>0-8650 3</p>	<p>PP NEW WINDSOR</p> <p>3/8" 3/8" 1/2" CSD</p> <p>0-8652 3</p>	<p>PP NEW WINDSOR</p> <p>3/8" 3/8" 1/2" HEP</p> <p>0-8654 3</p>	<p>PP NEW WINDSOR</p> <p>3/8" 3/8" 1/2" CSD</p> <p>0-8652 3</p>	<p>CAPTAIN MOEN BUTTON</p> <p>1/2" 1/2" 3/8" HEP</p> <p>0-8042 3</p>
<p>CAPTAIN MOEN BUTTON</p> <p>1/2" 1/2" 3/8" CSD</p> <p>0-8044 3</p>	<p>SMALL LASCO</p> <p>3/8" 3/8" 1/2" HEP</p> <p>0-8550 3</p>	<p>SMALL LASCO</p> <p>3/8" 3/8" 1/2" CSD</p> <p>0-8552 3</p>	<p>NEW WINDSOR</p> <p>1/2" 1/2" 3/8" HEP</p> <p>0-8660 3</p>	<p>NEW WINDSOR</p> <p>1/2" 1/2" 3/8" CSD</p> <p>0-8662 3</p>	<p>NEW WINDSOR</p> <p>1/2" 1/2" 3/8" HEP</p> <p>0-8664 3</p>	<p>NEW WINDSOR</p> <p>1/2" 1/2" 3/8" CSD</p> <p>0-8666 3</p>	<p>NEW WINDSOR</p> <p>1/2" 1/2" 3/8" HEP</p> <p>0-8670 3</p>
<p>NEW WINDSOR</p> <p>1/2" 1/2" 3/8" CSD</p> <p>0-8672 3</p>	<p>PP NEW WINDSOR</p> <p>3/8" 3/8" 1/2" HEP</p> <p>0-8674 3</p>	<p>NEW WINDSOR</p> <p>1/2" 1/2" 3/8" CSD</p> <p>0-8676 3</p>	<p>NEW WINDSOR</p> <p>1/2" 1/2" 3/8" HEP</p> <p>0-8678 3</p>	<p>NEW WINDSOR</p> <p>1/2" 1/2" 3/8" CSD</p> <p>0-8680 3</p>	<p>NEW WINDSOR</p> <p>1/2" 1/2" 3/8" HEP</p> <p>0-8682 3</p>	<p>NEW WINDSOR</p> <p>1/2" 1/2" 3/8" CSD</p> <p>0-8684 3</p>	<p>NEW WINDSOR</p> <p>1/2" 1/2" 3/8" HEP</p> <p>0-8686 3</p>
<p>NEW WINDSOR</p> <p>1/2" 1/2" 3/8" CSD</p> <p>0-8688 3</p>	<p>PP NEW WINDSOR</p> <p>3/8" 3/8" 1/2" HEP</p> <p>0-8690 3</p>	<p>NEW WINDSOR</p> <p>1/2" 1/2" 3/8" CSD</p> <p>0-8692 3</p>	<p>NEW WINDSOR</p> <p>1/2" 1/2" 3/8" HEP</p> <p>0-8694 3</p>	<p>NEW WINDSOR</p> <p>1/2" 1/2" 3/8" CSD</p> <p>0-8696 3</p>	<p>NEW WINDSOR</p> <p>1/2" 1/2" 3/8" HEP</p> <p>0-8698 3</p>	<p>NEW WINDSOR</p> <p>1/2" 1/2" 3/8" CSD</p> <p>0-8700 3</p>	<p>NEW WINDSOR</p> <p>1/2" 1/2" 3/8" HEP</p> <p>0-8702 3</p>

ITEM	DESCRIPTION	QTY.	ITEM	DESCRIPTION	QTY.
0-8000	Pop-Up Plug Button	6	0-8650	Hot PP New Windsor Button	6
0-8020	Hot 1/2" O.D. Sayco Button	6	0-8652	Cold PP New Windsor Button	6
0-8022	Cold 1/2" O.D. Sayco Button	6	0-8654	Diverter PP New Windsor Button	6
0-8030	Hot Chrome Porcelain Button	6	0-8660	PP New Small Verve Chrome Button	6
0-8032	Cold Chrome Porcelain Button	6	0-8662	Hot PP New Small Verve RED Insert only	6
0-8042	Hot Polished Brass Porcelain Button	6	0-8664	Cold PP New Small Verve BLUE Insert only	6
0-8044	Cold Polished Brass Porcelain Button	6	0-8670	PP New Large Verve Chrome Button	6
0-8110	Hot 3/4" O.D. American Standard Button	6	0-8672	Hot PP New Large Verve RED Insert only	6
0-8112	Cold 3/4" O.D. American Standard Button	6	0-8674	Cold PP New Large Verve RED Insert only	6
0-8530	Hot Streamway/Moen Button	6	0-8800	Hot 1-3/16" O.D. Kohler Coralis Button	6
0-8532	Cold Streamway/Moen Button	6	0-8802	Cold 1-3/16" O.D. Kohler Coralis Button	6
0-8550	Hot Small Lasco Button	6	0-8902	Hot Delta/Delex Button	6
0-8552	Cold Small Lasco Button	6	0-8904	Cold Delta/Delex Button	6
0-8560	Hot 7/8" O.D. American Standard Button	6	0-8906	Hot New Style Moen Button	6
0-8562	Cold 7/8" O.D. American Standard Button	6	0-8908	Cold New Style Moen Button	6
0-8570	Hot 13/16" O.D. Kohler Button	6	OCD0	Drawer for Cabinet W/32 Holes	1
0-8572	Cold 13/16" O.D. Kohler Button	6			

**WASHER ASSORTMENTS  
IN CLEAR PLASTIC CONTAINERS**

ITEM NO.	DESCRIPTION	CTN. QTY.
----------	-------------	--------------

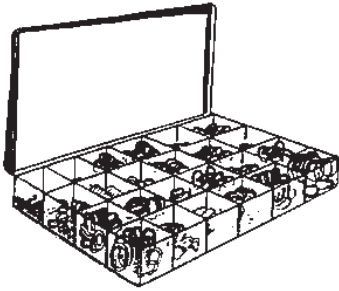

02-1614  
02-1796  
02-1902  
02-1060

**24 COMPARTMENT CONTAINERS (24 SIZES)**

02-1614	O-Rings 1100 Total Pieces	1
02-1796	Square Cut Packing 475 Total Pieces	1
02-1902	Fiber and Nylon Washers 1000 Total Pieces	1
02-1060	Bibb Washers 24 Sizes • 1350 Total Pieces	1

**12 COMPARTMENT CONTAINERS**

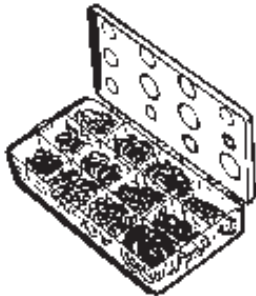

02-1602  
02-1150  
02-7050  
XS-562  
XS-592  
02-7650

02-1602	O-Ring 220 Total Pieces	1
02-1150	Bibb Washers 9 Sizes Blue Deluxe Bibb Washer 1/8 thru 1/2 3 Sizes Brass Bibb Screws 144 Total Pieces	1
02-7050	Square Cut Packing 6 Sizes Teflon Packing 6 Sizes Cloth Inserted Rubber 72 Total Pieces	1
XS-562	Brass Bibb Screws 10 Sizes 300 Total Pieces	1
XS-592	CP Handle Screws 12 Sizes 132 Total Pieces	1
02-7650	Nylon and Fiber Assortment 144 Total Pieces 12 Sizes of Nylon and Fiber Washers	1

**CARDED WASHER ASSORTMENTS**



02-1541



02-1921



02-7053



02-2361



XS-600  
XS-601



02-1249

02-1541	O-Ring • 12 pieces	6
02-1921	Fibre / Nylon • 12 pieces	6
02-7053	Square Cut • 4 pieces	6
02-2361	Cone Packing • 6 pieces	6
02-1249	No-Rotate • 4 pieces	6
XS-600	CP Handle Screws • 6 pieces	6
XS-601	Brass Bibb Screws • 6 pieces	6

**O-RING SPLICING KIT**



02-1616

**02-1616** A complete do-it-yourself kit to make your own -rings. Includes: glue, splicing jig, razor blade. With over 40 inches of cord for 0.070", 0.1.3", 0.139", 0.210", and 0.275"



# RUBBER GOODS

## SQUARE SHEET PACKING

DESCRIPTION	EACH	CTN/12
12" x 12" Rubber 3/32" Thick		02-1030
6" x 6" Rubber 6pc 1/8" Thick 6pc 1/16" Thick		02-1048
6" x 6" Rubber 1/16" Thick	02-1048E	
6" x 6" Rubber 1/8" Thick	02-1050E	
6" x 6" Cork Sheet Packing		02-1044
6" x 6" Cork Sheet Packing 1/16" Thick	02-1044-1	
6" x 6" Cork Sheet Packing 1/8" Thick	02-1044-2	
6" x 6" Fiber Sheet Packing	02-1046E	02-1046
6" x 6" Assorted Cork • Rubber • Fiber		02-1040

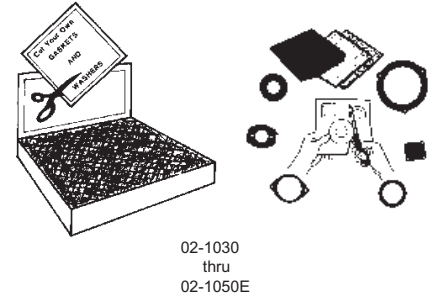

DESCRIPTION	ITEM	CTN.
-------------	------	------

## BIBB WASHER ASSORTMENT

Clear Box Assortment 24 Different Washers 1/8" thru 5/8L Flat and Beveled 1350 Total Pieces	02-1060	1
---	---------	---

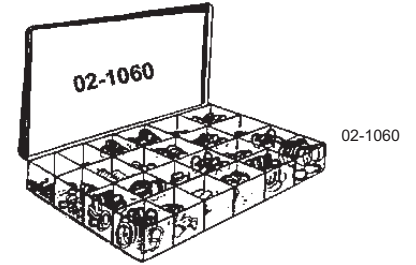

## HOME PACKS

20 Assorted Bibb Washers Flat Carded with 3 Brass Bibb Screws	02-1263	6
Same as above only Beveled	02-1265	6

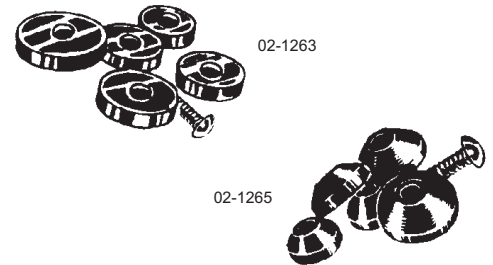

## HOME PACKS

00 Flat Bibb Washers 25 Pieces / Snap Pack	02-1267	6
3/8L Flat Bibb Washers 25 Pieces / Snap Pack	02-1269	6



## FIRST AID KIT

30 Plus of the most common Plumbing Washers In A Resealable Package	02-1261	6
--	---------	---

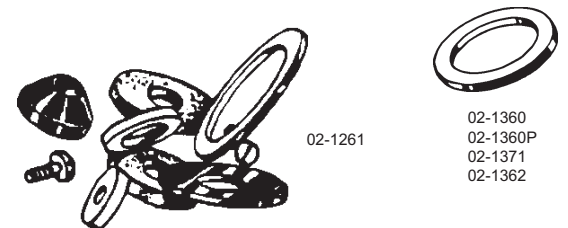

DESCRIPTION	BULK	CTN.	UPC	PCS	CTN.	CARD	PCS	CTN.
-------------	------	------	-----	-----	------	------	-----	------

## HOSE WASHERS

Rubber Hose Washer	02-1360	100	02-1360P	1	10	02-1371	10	6
Cloth Inserted Hose Washer	02-1364	100	02-1364P	1	10	02-1365	2	6
Display Carton 30 Clips of 12	02-1370	1						
Screened Hose Washer	02-1380	100	02-1380P	1	10	02-1381	2	6
1" Rubber Hose Washer	02-1362	12						

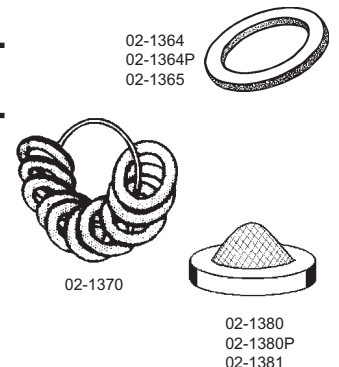

06/06/03



# BIBB WASHERS

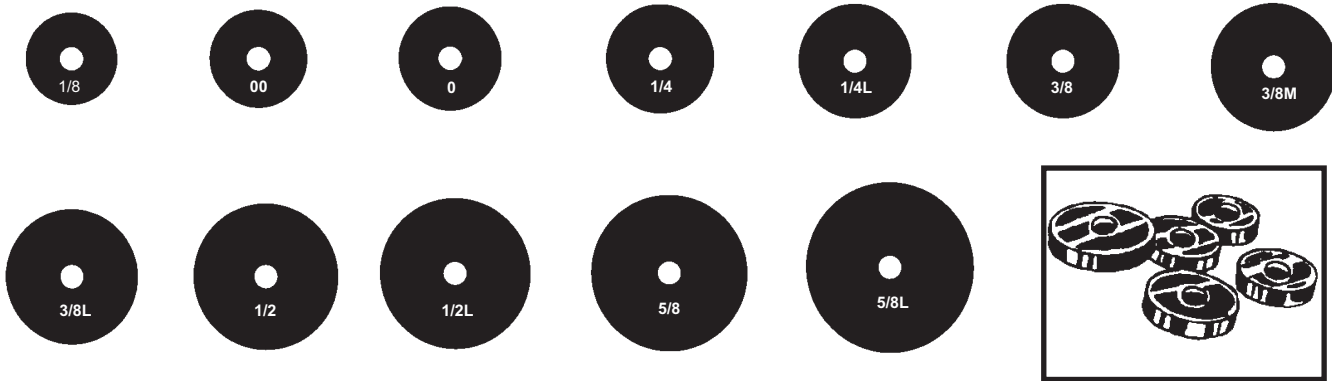

SIZE	FLAT BULK	CTN.	UPC 2/BAG	CTN.	CARDED 6/SNAP	CTN.	SIZE	BEVELED BULK	CTN.	UPC 2/BAG	CTN.	CARDED 6/SNAP	CTN.
------	-----------	------	-----------	------	---------------	------	------	--------------	------	-----------	------	---------------	------

## LASCO "LEAK-PRUF" FAUCET SEAT WASHERS

1/8	02-1160	100	02-1160P	12	02-1161	6	1/8	02-1130	100	02-1130P	12	02-1131	6
00	02-1100	100	02-1100P	12	02-1101	6	00	02-1070	100	02-1070P	12	02-1071	6
00	(12/Poly Bag)		02-1100D										
0	02-1102	100	02-1102P	12	02-1103	6	0	02-1072	100	02-1072P	12	02-1073	6
1/4	02-1104	100	02-1104P	12	02-1105	6	1/4	02-1074	100	02-1074P	12	02-1075	6
1/4L	02-1106	100	02-1106P	12	02-1107	6	1/4L	02-1076	100	02-1076P	12	02-1077	6
3/8	02-1108	100	02-1108P	12	02-1109	6	3/8	02-1078	100	02-1078P	12	02-1079	6
3/8M	02-1110	100	02-1110P	12	02-1111	6	3/8M	02-1080	100	02-1080P	12	02-1081	6
3/8L	02-1112	100	02-1112P	12	02-1113	6	3/8L	02-1082	100	02-1082P	12	02-1083	6
3/8L	(12/Poly Bag)		02-1112D										
1/2	02-1114	50	02-1114P	12	02-1115	6	1/2	02-1084	50	02-1084P	12	02-1085	6
1/2L	02-1116	50	02-1116P	12	02-1117	6	1/2L	02-1086	50	02-1086P	12	02-1087	6
5/8	02-1118	50	02-1118P	12	02-1119	6	5/8	02-1088	50	02-1088P	12	02-1089	6
5/8L	02-1120	50	02-1120P	12	02-1121	6	5/8L	02-1090	50	02-1090P	12	02-1091	6
1	02-1126	12											
Asst	02-1122	100	(16 per Pack)		02-1123	6	Asst	02-1092	100	(16per Pack)		02-1093	6

SIZE	FLAT BULK	CTN.	UPC 2/BAG	CTN.	CARDED 2/SNAP	CTN.	SIZE	BEVELED BULK	CTN.	UPC 2/BAG	CTN.	CARDED 2/SNAP	CTN.
------	-----------	------	-----------	------	---------------	------	------	--------------	------	-----------	------	---------------	------

## PIGNOSE™ • BLUE • SOFTER • FAUCET SEAT WASHERS

1/8	02-1160	100	02-1160P	12	02-1161	6	1/8	02-1130	100	02-1130P	12	02-1131	6
00	02-1162	100			02-1163	6	00	02-1132	100			02-1133	6
0	02-1164	100			02-1165	6	0	02-1134	100			02-1135	6
1/4	02-1166	100			02-1167	6	1/4	02-1136	100			02-1137	6
1/4L	02-1168	100			02-1169	6	1/4L	02-1138	100			02-1139	6
3/8	02-1170	100			02-1171	6	3/8	02-1140	100			02-1141	6
3/8M	02-1172	100			02-1173	6	3/8M	02-1142	100			02-1143	6
3/8L	02-1174	100			02-1175	6	3/8L	02-1144	100			02-1145	6
1/2	02-1176	50			02-1177	6	1/2	02-1146	50			02-1147	6





# RUBBER GOODS



Flat Bibb Washers



Beveled Bibb Washers



No-Rotate Washer



Brass & Monel Bibb Screw



Shower Drain Screw

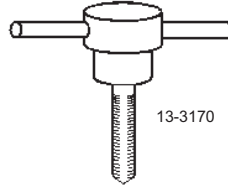

13-3170



CH1-18



AS732-37



Bibb Screw Assortments

SIZE	FLAT BULK	CTN.	BEVELED BULK	CTN.	SIZE	BULK	CTN.	UPC POLY BAG	CTN.	CARDED 2/SNAP	CTN.
------	-----------	------	--------------	------	------	------	------	--------------	------	---------------	------

## "MAGNUS" RED • HARDER FAUCET SEAT WASHERS

00	02-1202	100	02-1182	100
0	02-1204	100	02-1184	100
1/4	02-1206	100	02-1186	100
1/4L	02-1208	100	02-1188	100
3/8	02-1210	100	02-1190	100
3/8M	02-1212	100	02-1192	100
3/8L	02-1214	100	02-1194	100
1/2	02-1216	100	02-1196	100

## "NO-ROTATE" • SWIVEL WASHER FOR BROKEN RETAINER CUP

00	02-1230	50	02-1230P	12	02-1231	6
0	02-1232	50	02-1232P	12	02-1233	6
1/4	02-1234	50	02-1234P	12	02-1235	6
1/4L	02-1236	50	02-1236P	12	02-1237	6
3/8	02-1238	50	02-1238P	12	02-1239	6
3/8M	02-1240	50	02-1240P	12	02-1241	6
3/8L	02-1242	50	02-1242P	12	02-1243	6
1/2	02-1244	50	02-1244P	12	02-1245	6
Asst	02-1248	50	(4pcs per Pack)		02-1249	6

SIZE	LENGTH	BULK	CTN.	UPC 1/POLY BAG	CTN.
------	--------	------	------	----------------	------

## BRASS BIBB SCREWS

6/32	3/8"	XS-560	100	XS-560P	10
6/32	1/2"	XS-561	100		
8/32	1/4"	XS-550	100	XS-550P	10
8/32	3/8"	XS-555	100	XS-555P	10
8/32	1/2"	XS-552	100	XS-552P	10
10/24	3/8"	XS-553	100	XS-553P	10
10/24	1/2"	XS-554	100	XS-554P	10
10/28	3/8"	XS-556	100		
10/28	1/2"	XS-557	100		
10/32	3/8"	XS-558	100	XS-558P	10
10/32	1/2"	XS-559	100	XS-559P	10

## SHOWER DRAIN SCREWS

8/32	1/4"	XS-11	1
8/32	3/8"	XS-7	1

ITEM	DESCRIPTION
------	-------------

## BIBB SCREW ASSORTMENTS

- XS-562 12 Sizes Brass Bibb Screw Assortment 300 Total Pieces in Re-Useable Clear Plastic Case
- XS-1272 12 Sizes Monel Self-Locking Bibb Screw Assortment 220 Total Pieces in Re-Useable Clear Plastic Case
- XS-601 6 Pieces Assorted Brass Bibb Screws Carded

## SELF-LOCKING MONEL BIBB SCREWS

6/32	3/8"	XS-1256	1
6/32	1/2"	XS-1257	1
8/32	3/8"	XS-1262	1
8/32	1/2"	XS-1263	1
10/24	3/8"	XS-1258	1
10/24	1/2"	XS-1259	1
10/28	3/8"	XS-1260	1
10/28	1/2"	XS-1261	1
10/32	3/8"	XS-1264	1
10/32	1/2"	XS-1265	1

ITEM	DESCRIPTION
------	-------------

## BIBB SCREW TAP

13-3170 10-24 Thread Bibb Screw Tap

## BRASS FAUCET NUT

CH1-18 10-28 Thread Chicago Bibb Retainer Nut  
AS732-37 6-28 Thread Amer. Std. Brass Nut



SPECIALTY WASHERS

DESCRIPTION	OEM	BULK	CTN.	UPC	PCS	CTN.	CARD	PCS	CTN.
-------------	-----	------	------	-----	-----	------	------	-----	------

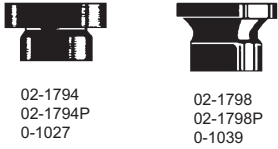

02-1794  
02-1794P  
0-1027

02-1798  
02-1798P  
0-1039

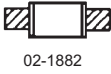

02-1882



AS72852-07



AS57583-07  
0-1059



AS69437-07

**AMERICAN STANDARD**

Aqua Seal Washer	72960	02-1794	12	02-1794P	2	10	0-1027	2	6
Cadet Hat Washer	72940	02-1798	12	02-1798P	1	10	0-1039	2	6
Colony Stem Packing	64705/6	02-1882	12						
Colony Wave Washer	72852	AS72852-07	1						
Aquarian S/L Seals	57583	AS57583-07	1				0-1059	3	6
Ultra Mix Seal	69437	AS69437-07	1						
Aqua Mix Seal	63827	AS63827-07	1						

**BRADLEY / SEARS**

Bradrol Washer	300-945	0-3092-1	1						
----------------	---------	----------	---	--	--	--	--	--	--



AS63827-07

0-3092-1

CH1-27  
CH1-327

**BRIGGS**

E-Z Close Washer		02-1792	1						
------------------	--	---------	---	--	--	--	--	--	--



02-1792

02-1764  
02-1764P  
0-1009

02-1766  
02-1766P

**CHICAGO**

Bibb Washer	1-21	02-1764	12	02-1764P	2	10	0-1009	2	6
N/S Stem Packing	1-119	02-1766	1	02-1766P	3	10			
O/S Monel Seat	1-27	CH1-27	1						
N/S Monel Seat	1-327	CH1-327	1						



02-1756  
02-1756P  
0-1015

02-1758  
02-1758P

02-1760  
02-1760P  
02-1761

**CRANE**

Dial-Eze Washer	F11035	02-1756	12	02-1756P	1	10	0-1015	2	6
Fiber Handle Disc	F12560	02-1758	12	02-1758P	2	10			
Cork Gasket	F10590	02-1760	12	02-1760P	1	10	02-1761	2	6

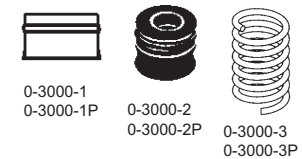

0-3000-1  
0-3000-1P

0-3000-2  
0-3000-2P

0-3000-3  
0-3000-3P

**DELTA / PEERLESS**

Short N/S Seat		0-3000-1	100	0-3000-1P	1	10			
Long O/S Seat		0-3000-2	100	0-3000-2P	1	10			
Long O/S Spring		0-3000-3	100	0-3000-3P	1	10			
Short N/S Spring		0-3000-4	100	0-3000-4P	1	10			
Triangular Cam	#61	0-3000-5	100	0-3000-5P	1	10			
Slotted Cam	#188	0-3000-6	100	0-3000-6P	1	10			
Cam Packing		0-3000-7	100	0-3000-7P	1	10			

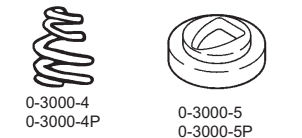

0-3000-4  
0-3000-4P

0-3000-5  
0-3000-5P

**ELJER**

Diverter Washer	5689	02-1290	12						
-----------------	------	---------	----	--	--	--	--	--	--

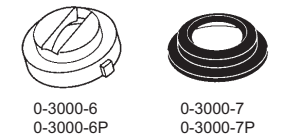

0-3000-6  
0-3000-6P

0-3000-7  
0-3000-7P

**GERBER**

Diverter Washer	90-380	02-1898	12	02-1898P	1	10			
Washerless Seal	90-497	02-1900	12						



02-1290

02-1900

02-1898  
02-1898P



SPECIALTY WASHERS

DESCRIPTION	OEM	BULK	CTN.	UPC	PCS	CTN.	CARD	PCS	CTN.
-------------	-----	------	------	-----	-----	------	------	-----	------

**KOHLER**

Diverter Washer	02-1282	1							
Diverter Ball Washer	02-1284	1							
Hot Valvet Sleeve	KO-22947	1							
Cold Valvet Sleeve	KO-22948	1							

**MIXET**

Square Cut Packing	02-1778	1							
Brass Washer	02-1906	1							

**NIBCO**

Washerless Seal	0-4190-1	1							
Washerless Spring	0-4190-2	1							

**MUELLER**

Mueller Ball	02-1280	1							
--------------	---------	---	--	--	--	--	--	--	--

**PRICE PFISTER**

Washerless Seal	949-360	02-1784	12	02-1784P	1	10	0-2075	2	6
Cage Stem Washer	949-300	02-1888	12	02-1888P	1	10			
Mobile Home Washer		02-1752	12	02-7520P	1	10			
Ceramic Shower Seal	950-980	02-7510	1	02-7510P	1	10	02-7511	2	6
Ceramic Lav Seal		02-7514	1	02-7514P	1	10	02-7515	2	6
Ceramic Stop Limit	970-780	02-7512	1						

**T & S BRASS**

Barrel Washer	02-7550	1							
---------------	---------	---	--	--	--	--	--	--	--

**STERLING**

Diverter Washer	S-0723	02-1898	12	02-1898P	1	12			
-----------------	--------	---------	----	----------	---	----	--	--	--

**UR / MILWAUKEE**

Diverter Washer	02-1286	1							
Washerless Seat	0-3090-1	1							
Washerless Spring	0-3090-2	1							

**VALLEY**

Washerless Seat	0-3080-1	1							
Washerless Spring	0-3080-2	1							



02-1282



02-1284

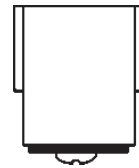

KO-22947  
KO-22948



02-1778



02-1906



0-4190-1



02-1280



0-4190-2



02-1784  
02-1784P  
0-2075



02-1888  
02-1888P



02-1752  
02-7520P



02-7514  
02-7514P  
02-7515



02-7512



02-7550



02-1898  
02-1898P



02-1286



0-3090-1



0-3090-2



0-3080-1



0-3080-2



## O-RING CHART

POP	I.D.	O.D.	THICK	BULK	CTN.	POLY BAG 12/BAG	CTN.	UPC BAG 1/BAG	CTN.	CARD 2/CARD	CTN.	DANCO	KIRKHL	P & M
#0	3/16	1/4	1/32	02-7380	100					02-7381	6			
#1	1/8	1/4	1/16	02-1624	100	02-1624D	10	02-1624P	10	02-1625	6	35774		14503
#2	5/32	9/32	1/16	02-1626	100	02-1626D	10	02-1626P	10	02-1627	6	35775		14504
#3	3/16	5/16	1/16	02-1578	100	02-1578D	10	02-1578P	10	02-1579	6	35750	R-79	14505
#3						<b>02-1578C</b>	=	<b>Bag of 100</b>						
#4	7/32	11/32	1/16	02-1628	100	02-1628D	10	02-1628P	10	02-1629	6			14506
#5	1/4	3/8	1/16	02-1512	100	02-1512D	10	02-1512P	10	02-1513	6	35722	R-46	14507
#5						<b>02-1512C</b>	=	<b>Bag of 100</b>						
#6	1/4	7/16	3/32	02-1450	100	02-1450D	10	02-1450P	10	02-1451	6	35715		14692
#7	1/4	1/2	1/8	02-1468	100	02-1468D	10	02-1468P	10	02-1469	6	35870		14694
#8	5/16	7/16	1/16	02-1508	100	02-1508D	10	02-1508P	10	02-1509	6	35724	R-44	14508
#8						<b>02-1508C</b>	=	<b>Bag of 100</b>						
#9	5/16	1/2	3/32	02-1454	100	02-1454D	10	02-1454P	10	02-1455	6	35711		14693
#10	5/16	9/16	1/8	02-1552	100	02-1552D	10	02-1552P	10	02-1553	6	35745	R-66	14642
#11	23/64	1/2	1/16	SO-012										
#12	23/64	9/16	3/32	02-1582	100	02-1582D	10	02-1582P	10	02-1583	6	35719		
#13	23/64	37/64	7/64	02-1404	100	02-1404D	10	02-1404P	10	02-1405	6			14691
#14	23/64	5/8	1/8	SO-204										
#15	3/8	1/2	1/16	02-1534	100	02-1534D	10	02-1534P	10	02-1535	6	35724	R-57	14509
#15						<b>02-1534C</b>	=	<b>Bag of 100</b>						
#16	3/8	9/16	3/32	02-1520	100	02-1520D	10	02-1520P	10	02-1521	6	35725	R-50	14603
#16						<b>02-1520C</b>	=	<b>Bag of 100</b>						
#16						<b>02-1521D</b>	=	<b>Card of 12</b>	6					
#17	3/8	5/8	1/8	02-1560	100	02-1560D	10	02-1560P	10	02-1561	6	35719	R-70	14643
#18	7/16	9/16	1/16	02-1556	100	02-1556D	10	02-1556P	10	02-1557	6	35755	R-68	14510
#18						<b>02-1556C</b>	=	<b>Bag of 100</b>						
#19	7/16	5/8	3/32	02-1514	100	02-1514D	10	02-1514P	10	02-1515	6	35726	R-47	14604
#19						<b>02-1514C</b>	=	<b>Bag of 100</b>						
#20	7/16	11/16	1/8	02-1530	100	02-1530D	10	02-1530P	10	02-1531	6	35871	R-55	14645
#21	1/2	5/8	1/16	02-1504	100	02-1504D	10	02-1504P	10	02-1505	6	35742	R-42	14651
#22	1/2	11/16	3/32	02-1506	100	02-1506D	10	02-1506P	10	02-1507	6	35756	R-43	14605
#22						<b>02-1506C</b>	=	<b>Bag of 100</b>						
#23	1/2	3/4	1/8	02-1400	100	02-1400D	10	02-1400P	10	02-1401	6	35872		14647
#24	33/64	5/8	1/16	02-1548	100	02-1548D	10	02-1548P	10	02-1549	6	35738	R-64	14651
#27	9/16	11/16	1/16	02-1414	100			02-1414P	10	02-1415	6	35761		14512
#28	9/16	3/4	3/32	02-1516	100	02-1516D	10	02-1516P	10	02-1517	6	35728	R-48	14606
#28						<b>02-1516C</b>	=	<b>Bag of 100</b>						
#29	9/16	13/16	1/8	02-1402	100			02-1402P	10	02-1403	6	35873		
#30	5/8	3/4	1/16	02-1562	100	02-1562D	10	02-1562P	10	02-1563	6	35767	R-71	14513
#30						<b>02-1562C</b>	=	<b>Bag of 100</b>						
#31	5/8	13/16	3/32	02-1522	100	02-1522D	10	02-1522P	10	02-1523	6	35729	R-51	14607
#31						<b>02-1522C</b>	=	<b>Bag of 100</b>						
#32	5/8	7/8	1/8	02-1470	100			02-1470P	10	02-1471	6	35874		14676
#36	41/64	51/64	5/64	02-1632	100	02-1632D	10	02-1632P	10	02-1633	6	35714		14550
#37	11/16	13/16	1/16	02-1580	100	02-1580D	10	02-1580P	10	02-1581	6	35784	R-80	14514
#37						<b>02-1580C</b>	=	<b>Bag of 100</b>						
#38	11/16	7/8	3/32	02-1518	100	02-1518D	10	02-1518P	10	02-1519	6	35730	R-49	14608
#38						<b>02-1518C</b>	=	<b>Bag of 100</b>						
#39	11/16	15/16	1/8	02-1604	100			02-1604P	10	02-1605	6	35875		
#40	3/4	7/8	1/16	02-1538	100	02-1538D	10	02-1538P	10	02-1539	6	35744	R-59	14515



## O-RING CHART

POP	I.D.	O.D.	THICK	BULK	CTN.	POLY BAG 12/BAG	CTN.	UPC BAG 1/BAG	CTN.	CARD 2/CARD	CTN.	DANCO	KIRKHL	P & M
#41	3/4	15/16	3/32	02-1524	100	02-1524D	10	02-1524P	10	02-1525	6		R-52	14609
#41						<b>02-1524C</b>	=	<b>Bag of 100</b>						
#42	3/4	1	1/8	02-1510	100	02-1510D	10	02-1510P	10	02-1511	6	35732	R-45	14650
#43	13/16	15/16	1/16	02-1576	100	02-1576D	10	02-1576P	10	02-1577	6	35746	R-78	14516
#44	13/16	1	3/32	02-1596	100	02-1596D	10	02-1596P	10	02-1597	6	35771		14610
#45	13/16	1-1/16	1/8	02-1526	100	02-1526D	10	02-1526P	10	02-1527	6	35733	R-53	14651
#46	7/8	1	1/16	02-1558	100	02-1558D	10	02-1558P	10	02-1559	6	35780	R-96	14517
#47	7/8	1-1/16	3/32	02-1528	100	02-1528D	10	02-1528P	10	02-1529	6	35734	R-54	14612
#48	7/8	1-1/8	1/8	02-1532	100	02-1532D	10	02-1532P	10	02-1533	6	35741	R-56	14652
#49	15/16	1-1/16	1/16	02-1550	100	02-1550D	10	02-1550P	10	02-1551	6	35747	R-65	14518
#50	15/16	1-1/8	3/32	02-1564	100	02-1564D	10	02-1564P	10	02-1565	6	35776	R-72	14613
#51	15/16	1-3/16	1/8	02-1566	100	02-1566D	10	02-1566P	10	02-1567	6	35735	R-73	14653
#52	31/32	1-3/32	1/16	02-1630	100	02-1630D	10	02-1630P	10	02-1631	6			14520
#55	1	1-1/8	1/16	SO-022										
#56	1	1-3/16	3/32	02-1546	100	02-1546D	10	02-1546P	10	02-1547	6	35707	R-63	14614
#57	1	1-1/4	1/8	02-1482	100	02-1482D	10	02-1482P	10	02-1483	6	35736		14654
#58	1-1/16	1-3/16	1/16	02-1544	100	02-1544D	10	02-1544P	10	02-1545	6	35740	R-62	14521
#59	1-1/16	1-1/4	3/32	SO-121										
#60	1-1/16	1-5/16	1/8	02-1484	100	02-1484D	10	02-1484P	10	02-1485	6	35777		14655
#61	1-1/8	1-1/4	1/16	02-1568	100	02-1568D	10	02-1568P	10	02-1569	6	35743	R-74	14522
#62	1-1/8	1-5/16	3/32	02-1458	100	02-1458D	10	02-1458P	10	02-1459	6	35778		14616
#63	1-1/8	1-3/8	1/8	02-1536	100	02-1536D	10	02-1536P	10	02-1537	6	35757	R-58	14656
#64	1-3/16	1-5/16	1/16	02-1424	100			02-1424P	10	02-1425	6	35769		14523
#65	1-3/16	1-3/8	3/32	02-1586	100	02-1586D	10	02-1586P	10	02-1587	6	35759	R-82	14618
#66	1-3/16	1-7/16	1/8	02-1606	100			02-1606P	10	02-1607	6			
#67	1-1/4	1-3/8	1/16	SO-026										
#68	1-1/4	1-7/16	3/32	02-1620	100			02-1620P	10			35710	R-83	14619
#69	1-1/4	1-1/2	1/8	02-1570	100	02-1570D	10	02-1570P	10	02-1571	6	35748	R-75	14658
#70	1-5/16	1-7/16	1/16	02-1428	100			02-1428P	10			35753		14525
#71	1-5/16	1-1/2	3/32	02-1542	100	02-1542D	10	02-1542P	10	02-1543	6	35739	R-61	14620
#72	1-5/16	1-9/16	1/8	02-1554	100	02-1554D	10	02-1554P	10	02-1555	6	35758	R-67	14659
#73	1-3/8	1-1/2	1/16	02-1432	100			02-1432P	10	02-1433	6	35770		14526
#74	1-3/8	1-9/16	3/32	SO-126										
#75	1-3/8	1-5/8	1/8	SO-220										
#77	1-7/16	1-5/8	3/32	02-1594	100	02-1594D	10	02-1594P	10	02-1595	6	35709	R-81	14623
#79	1-1/2	1-5/8	1/16	SO-029										
#80	1-1/2	1-11/16	3/32	SO-128										
#81	1-1/2	1-3/4	1/8	02-1618	100			02-1618P	10					
#83	1-9/16	1-3/4	3/32	02-1584	100	02-1584D	10	02-1584P	10	02-1585	6	35752		14625
#83Q	1-9/16	1-3/4	Quad	02-7188	100									
#85	1-5/8	1-3/4	1/16	02-1572	100	02-1572D	10	02-1572P	10	02-1573	6	35766	R76	14528
#86	1-5/8	1-13/16	3/32	02-1460	100			02-1460P	10					14626
#87	1-5/8	1-7/8	1/8	02-1488	100	02-1488D	10	02-1488P	10	02-1489	6	35763		14663
#88	1-5/8	2	3/16	02-1464	100	02-1464D	10	02-1464P	10	02-1465	6			14678
#90	1-11/16	1-7/8	3/32	02-1462	100	02-1462D	10	02-1462P	10			35773		14627
#92	1-3/4	1-7/8	1/16	02-1438	100	02-1438D	10	02-1438P	10	02-1439	6	35779		14529
#93	1-3/4	1-15/16	3/32	02-1590	100	02-1590D	10	02-1590P	10	02-1591	6			14629
#94	1-3/4	2	1/8	02-1490	100	02-1490D	10	02-1490P	10	02-1491	6			14677
#95	1-3/4	2-1/8	3/16	02-1466	100	02-1466D	10	02-1466P	10	02-1467	6			
#96	1-7/8	2	1/16	02-1622	100			02-1622P	10				R-84	14555



# O-RING CHART

POP	I.D.	O.D.	THICK	BULK	CTN.	POLY BAG 12/BAG	CTN.	UPC BAG 1/BAG	CTN.	CARD 2/CARD	CTN.	DANCO	KIRKHL	P & M
#97	1-7/8	2-1/16	3/32	02-1600	100			02-1600P	10				R-85	14631
#98	1-7/8	2-1/8	1/8	02-1492	100	02-1492D	10	02-1492P	10	02-1493	6			14696
#101	48mm	54mm	3mm	02-1598	100			02-1598P	10					14698
#102	2	2-1/8	1/16	SO-033										
#103	2	2-3/16	3/32	02-1574	100	02-1574D	10	02-1574P	10	02-1575	6	35705	R-77	
#106	2	2-3/16	Quad	02-1592	100			02-1592P	10					18161
#108	2-3/16	2-7/16	1/8	02-7236	100									
#112	2-3/8	2-9/16	3/32	02-1608	100									
#113	2-1/2	2-3/4	1/8	02-7200	100									
#114	2-1/2	2-7/8	3/16	02-7250	100									
#115	2-5/8	2-7/8	1/8	02-1610	100									
#117	2-3/4	3	1/8	02-7204	100									
#118	2-3/4	3-1/8	3/16	02-7254	100									
#120	3	3-1/4	1/8	02-7208	100									
#121	3	3-7/8	3/16	02-7258	100									
#123	3-1/4	3-1/2	1/8	02-7212	100									
#124	3-1/4	3-5/8	3/16	02-7262	100									
#126	3-3/8	3-5/8	1/8	02-7214	100									
#127	3-3/8	3-11/16	5/32	02-7234	100									
#128	3-1/2	3-3/4	1/8	02-7216	100									
#129	3-1/2	3-7/8	3/16	02-7266	100									
#132	3-3/4	4	1/8	02-7220	100									
#133	3-3/4	4-1/8	3/16	02-7270	100									
#136	4	4-1/4	1/8	02-7224	100									
#137	4	4-3/8	3/16	02-7274	100									
#140	4-1/4	4-5/8	3/16	02-7278	100									
#144	4-1/2	4-7/8	3/16	02-7282	100									
#148	4-3/4	5-1/8	3/16	02-7286	100									
#150	5	5-3/8	3/16	02-7290	100									
#154	5-1/4	5-5/8	3/16	02-7294	100									
#158	5-3/8	5-5/8	1/8	02-7296	100									
#159	5.39	5.71	.16	02-7300	100									
#160	5-1/2	5-7/8	3/16	02-7298	100									





















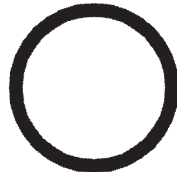







# O-RINGS

DANCO #	KIRK #	P&M #	DANCO #	KIRK #	P&M #	DANCO #	KIRK #	P&M #
<b>35738</b>	<b>R-64</b>	<b>14651</b>	35761, 35749, 35768		<b>14512</b>	<b>35728</b>	<b>R-48</b>	<b>14606</b>
I.D. 33/64 0.507	O.D. 5/8 0.627	THICK 1/16 0.060	I.D. 9/16 0.551	O.D. 11/16 0.691	THICK 1/16 0.070	I.D. 9/16 0.549	O.D. 3/4 0.755	THICK 3/32 0.103
								
Aqua Seal Version 2			Sayco, GerberWasherless, Am Std Push-Pull Ultra Mix, Reliant			Cart-Bradley, Moen, Mixet, Union Brass, Spouts-Sterling, Streamway, Moen, UR, Valley, Briggs, Central, Indiana, Crane, Rivera, Eljer, Sayco, Grohe, Delex, Peerless		
LASCO# <b>02-1548</b>			LASCO# <b>02-1414</b>			LASCO# <b>02-1516</b>		
<b>24</b>			<b>27</b>			<b>28</b>		
<b>35873</b>			35767, 35754	<b>R-71</b>	<b>14513</b>	<b>35729</b>	<b>R-51</b>	<b>14607</b>
I.D. 9/16 0.564	O.D. 13/16 0.824	THICK 1/8 0.139	I.D. 5/8 0.614	O.D. 3/4 0.754	THICK 1/16 0.070	I.D. 5/8 0.612	O.D. 13/16 0.818	THICK 3/32 0.103
								
Various			A.S. Colony Div., Valley Div., A.S. S/L Ultra Mix, Sayco, Indiana			Moen Cart., UR Cart., AS Div., Elkay/Milwaukee, Fisher, Spouts-Indiana, Union Brass Wall Mount, Kohler Ballcock		
LASCO# <b>02-1402</b>			LASCO# <b>02-1562</b>			LASCO# <b>02-1522</b>		
<b>29</b>			<b>30</b>			<b>31</b>		
<b>35874</b>		<b>14676</b>	<b>35714</b>		<b>14550</b>	<b>35784</b>	<b>R-80</b>	<b>14514</b>
I.D. 5/8 0.608	O.D. 7/8 0.886	THICK 1/8 0.139	I.D. 41/64 0.640	O.D. 51/64 0.800	THICK 5/64 0.080	I.D. 11/16 0.676	O.D. 13/16 0.816	THICK 1/16 0.070
								
Various			American Standard Colony			Washerless Carts-Valley II, Delex UR/Milwaukee, Sterling S/V, Bradley S/V		
LASCO# <b>02-1470</b>			LASCO# <b>02-1632</b>			LASCO# <b>02-1580</b>		
<b>32</b>			<b>36</b>			<b>37</b>		
<b>35730</b>	<b>R-49</b>	<b>14608</b>	<b>35875</b>			<b>35744</b>	<b>R-59</b>	<b>14515</b>
I.D. 11/16 0.674	O.D. 7/8 0.880	THICK 3/32 0.103	I.D. 11/16 0.676	O.D. 15/16 0.940	THICK 1/8 0.130	I.D. 3/4 0.739	O.D. 7/8 0.879	THICK 1/16 0.070
								
Kohler Div., Indiana, Union Brass Div., Spouts- AM Kitchen, Briggs, Kohler, Harcraft, Price Pfister						Eljer, Grohe, American Standard, Kohler		
LASCO# <b>02-1518</b>			LASCO# <b>02-1604</b>			LASCO# <b>02-1538</b>		
<b>38</b>			<b>39</b>			<b>40</b>		











# O-RINGS

DANCO #	KIRK #	P&M #	DANCO #	KIRK #	P&M #	DANCO #	KIRK #	P&M #
	<b>R-52</b>	<b>14609</b>	<b>35732</b>	<b>R-45</b>	<b>14650</b>	35746, 35731	<b>R-78</b>	<b>14516</b>
I.D. 3/4 0.737	O.D. 15/16 0.943	THICK 3/32 0.103	I.D. 3/4 0.734	O.D. 1" 1.012	THICK 1/8 0.139	I.D. 13/16 0.801	O.D. 15/16 0.941	THICK 1/16 0.070
								
Valley O/S S/L Cart., Streamway, Case 62, Spouts-A.S., Elkay, Gerber, Kohler, U.R., Union Brass, Price Pfister, Valley			Crane-Temple			Spouts-Price Pfister Wall Mount, Valley Hi-Rise, Gerber, Eljer, Kelwin, Harcraft		
LASCO# <b>02-1524</b> <span style="float: right;"><b>41</b></span>			LASCO# <b>02-1510</b> <span style="float: right;"><b>42</b></span>			LASCO# <b>02-1576</b> <span style="float: right;"><b>43</b></span>		
<b>35771</b>		<b>14610</b>	<b>35733</b>	<b>R-53</b>	<b>14651</b>	<b>35780</b>	<b>R-69</b>	<b>14517</b>
I.D. 13/16 0.799	O.D. 1" 1.005	THICK 3/32 0.103	I.D. 13/16 0.796	O.D. 1-1/16 1.074	THICK 1/8 0.139	I.D. 7/8 0.864	O.D. 1" 1.004	THICK 1/16 0.070
								
Crane Spout			Spouts-Eljer, Indiana, Moen, Stanadyne			Harcraft Spout, U.R. Div., Acorn		
LASCO# <b>02-1596</b> <span style="float: right;"><b>44</b></span>			LASCO# <b>02-1526</b> <span style="float: right;"><b>45</b></span>			LASCO# <b>02-1558</b> <span style="float: right;"><b>46</b></span>		
<b>35734</b>	<b>R-54</b>	<b>14612</b>	<b>35741</b>	<b>R-56</b>	<b>14652</b>	<b>35747</b>	<b>R-65</b>	<b>14518</b>
I.D. 7/8 0.862	O.D. 1-1/16 1.068	THICK 3/32 0.103	I.D. 7/8 0.859	O.D. 1-1/8 1.137	THICK 1/8 0.139	I.D. 15/16 0.926	O.D. 1-1/16 1.066	THICK 1/16 0.070
								
Spouts-A.M. Kitchen, A.S., Harcraft, Reocal, Kohler, Sterling, U.R.			Spouts-Delex, Peerless			Kohler Constellation, A.S. Push-Pull Shower		
LASCO# <b>02-1528</b> <span style="float: right;"><b>47</b></span>			LASCO# <b>02-1532</b> <span style="float: right;"><b>48</b></span>			LASCO# <b>02-1550</b> <span style="float: right;"><b>49</b></span>		



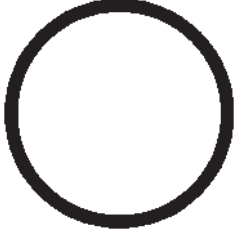

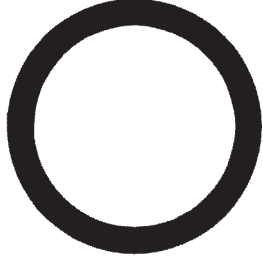

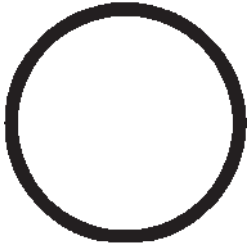

# O-RINGS

DANCO #	KIRK #	P&M #	DANCO #	KIRK #	P&M #	DANCO #	KIRK #	P&M #
<b>35776</b>	<b>R-72</b>	<b>14613</b>	<b>35735</b>	<b>R-73</b>	<b>14653</b>			<b>14520</b>
I.D. 15/16 0.924	O.D. 1-1/8 1.130	THICK 3/32 0.103	I.D. 15/16 0.921	O.D. 1-3/16 1.199	THICK 1/8 0.139	I.D. 31/32 0.968	O.D. 1-3/32 1.108	THICK 1/16 0.070
								
Spouts-Delex, Peerless, Eljer, Valley II, U.R., Milwaukee			Wolverine, Sears			Various		
LASCO# <b>02-1564</b> <b>50</b>			LASCO# <b>02-1566</b> <b>51</b>			LASCO# <b>02-1630</b> <b>52</b>		
DANCO #	KIRK #	P&M #	DANCO #	KIRK #	P&M #	DANCO #	KIRK #	P&M #
			35707, 35737	<b>R-63</b>	<b>14614</b>	<b>35736</b>		<b>14654</b>
I.D. 1" 1.005	O.D. 1-1/8 1.137	THICK 1/16 0.070	I.D. 1" 0.986	O.D. 1-3/16 1.193	THICK 3/32 0.103	I.D. 1" 0.984	O.D. 1-1/4 1.262	THICK 1/8 0.139
								
LASCO# <b>Special Order (022)</b> <b>55</b>			LASCO# <b>02-1546</b> <b>56</b>			LASCO# <b>02-1482</b> <b>57</b>		
Moen			Speakman					
DANCO #	KIRK #	P&M #	DANCO #	KIRK #	P&M #	DANCO #	KIRK #	P&M #
<b>35740</b>	<b>R-62</b>	<b>14521</b>				<b>35777</b>		<b>14655</b>
I.D. 1-1/16 1.051	O.D. 1-3/16 1.191	THICK 1/16 0.070	I.D. 1-1/16 1.051	O.D. 1-1/4 1.262	THICK 3/32 0.103	I.D. 1-1/16 1.046	O.D. 1/5/16 1.324	THICK 1/8 0.139
								
Pop-Ups-Gerber, Grohe, Central, Sayco			Wolverine S/L					
LASCO# <b>02-1544</b> <b>58</b>			LASCO# <b>Special Order (121)</b> <b>59</b>			LASCO# <b>02-1484</b> <b>60</b>		

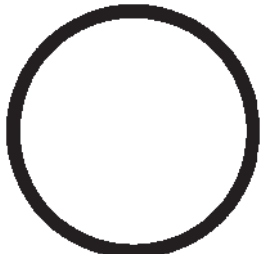

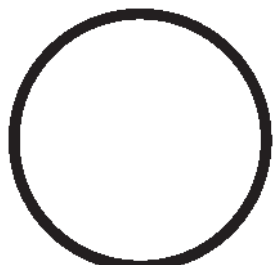
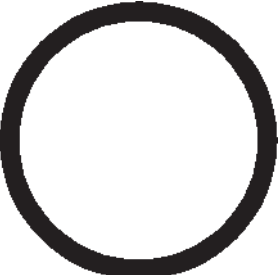





# O-RINGS

DANCO #	KIRK #	P&M #	DANCO #	KIRK #	P&M #	DANCO #	KIRK #	P&M #
<b>35743</b>	<b>R-74</b>	<b>14522</b>	35778, 35772		<b>14616</b>	<b>35757</b>	<b>R-58</b>	<b>14656</b>
I.D. 1-1/8 1.114	O.D. 1-1/4 1.254	THICK 1/16 0.070	I.D. 1-1/8 1.112	O.D. 1-5/16 1.318	THICK 3/32 0.103	I.D. 1-1/8 1.109	O.D. 1-3/8 1.387	THICK 1/8 0.139
								
Valley N/S Cartridge W/Diverter American Standard			Symmons			Moen Wall Mount Spout		
LASCO# <b>02-1568</b> <b>61</b>			LASCO# <b>02-1458</b> <b>62</b>			LASCO# <b>02-1536</b> <b>63</b>		
<b>35769</b>		<b>14523</b>	<b>35759</b>	<b>R-82</b>	<b>14618</b>			
I.D. 1-3/16 1.176	O.D. 1-5/16 1.316	THICK 1/16 0.070	I.D. 1-3/16 1.174	O.D. 1-3/8 1.380	THICK 3/32 0.103	I.D. 1-3/16 1.171	O.D. 1-7/16 1.449	THICK 1/8 0.139
								
American Standard Push-Pull, Eljer Pop-Up			Sloan Flush Valve Stop Nipple					
LASCO# <b>02-1424</b> <b>64</b>			LASCO# <b>02-1586</b> <b>65</b>			LASCO# <b>02-1606</b> <b>66</b>		
			<b>35710</b>	<b>R-83</b>	<b>14619</b>	<b>35748</b>	<b>R-75</b>	<b>14658</b>
I.D. 1-1/4 1.262	O.D. 1-3/8 1.380	THICK 1/16 0.070	I.D. 1-1/4 1.237	O.D. 1-7/16 1.443	THICK 3/32 0.103	I.D. 1-1/4 1.234	O.D. 1-1/2 1.512	THICK 1/8 0.139
								
			Price Pfister S/L Spout (PP950-800)			Delta N/S Spout		
LASCO# <b>Special Order (026)</b> <b>67</b>			LASCO# <b>02-1620</b> <b>68</b>			LASCO# <b>02-1570</b> <b>69</b>		

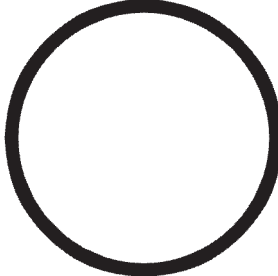
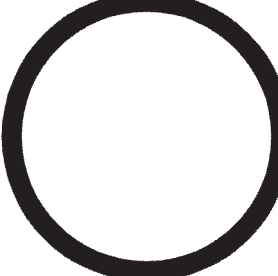

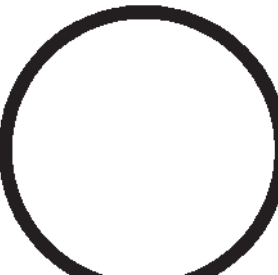
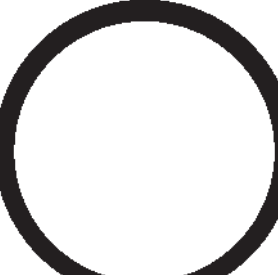

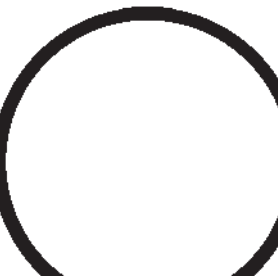



# O-RINGS

DANCO #	KIRK #	P&M #	DANCO #	KIRK #	P&M #	DANCO #	KIRK #	P&M #
<b>35753</b>		<b>14525</b>	<b>35739</b>	<b>R-61</b>	<b>14620</b>	<b>35758</b>	<b>R-67</b>	<b>14659</b>
I.D. 1-5/16 1.301	O.D. 1-7/16 1.441	THICK 1/16 0.070	I.D. 1-5/16 1.299	O.D. 1-1/2 1.505	THICK 3/32 0.103	I.D. 1-5/16 1.296	O.D. 1-9/16 1.574	THICK 1/8 0.139
								
Nile Spout, Kohler, Peerless			Spouts-A.S., Crane, Nile, U.R., Delta O/S, Peerless, Valley N/S, Gerber S/L, U.R. Ballcock			Moen Spout, Stanadyne		
LASCO# <b>02-1428</b> <span style="float: right;"><b>70</b></span>			LASCO# <b>02-1542</b> <span style="float: right;"><b>71</b></span>			LASCO# <b>02-1554</b> <span style="float: right;"><b>72</b></span>		
<b>35770</b>		<b>14526</b>						
I.D. 1-3/8 1.364	O.D. 1-1/2 1.504	THICK 1/16 0.070	I.D. 1-3/8 1.364	O.D. 1-9/16 1.574	THICK 3/32 0.103	I.D. 1-3/8 1.364	O.D. 1-5/8 1.630	THICK 1/8 0.139
								
Nibco S/L Cartridge								
LASCO# <b>02-1432</b> <span style="float: right;"><b>73</b></span>			LASCO# <b>Special Order (126)</b> <span style="float: right;"><b>74</b></span>			LASCO# <b>Special Order (220)</b> <span style="float: right;"><b>75</b></span>		
<b>35709, 35764</b>	<b>R-81</b>	<b>14623</b>						
I.D. 1-7/16 1.424	O.D. 1-5/8 1.630	THICK 3/32 0.103	I.D. 1-1/2 1.484	O.D. 1-5/8 1.630	THICK 1/16 0.070	I.D. 1-1/2 1.484	O.D. 1-11/16 1.674	THICK 3/32 0.103
								
Sterling S/L Mix Valve, Bradley Spout								
LASCO# <b>02-1594</b> <span style="float: right;"><b>77</b></span>			LASCO# <b>Special Order (029)</b> <span style="float: right;"><b>79</b></span>			LASCO# <b>Special Order (128)</b> <span style="float: right;"><b>80</b></span>		

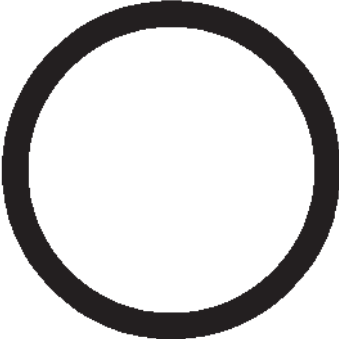
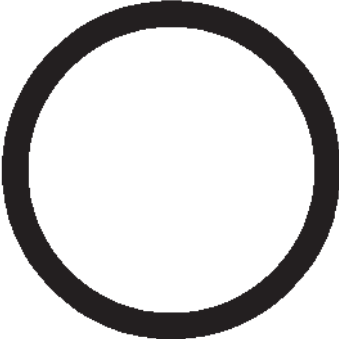
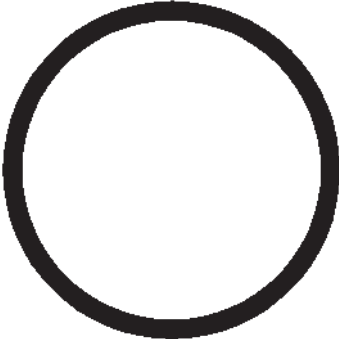
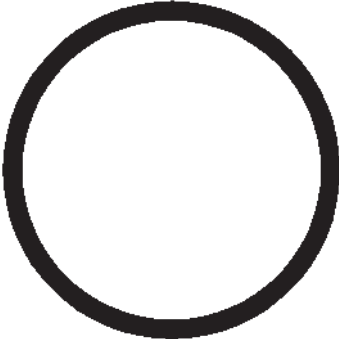

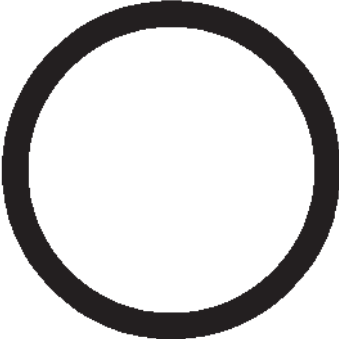
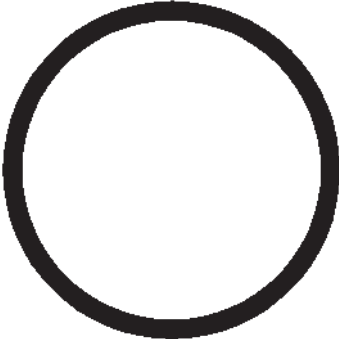

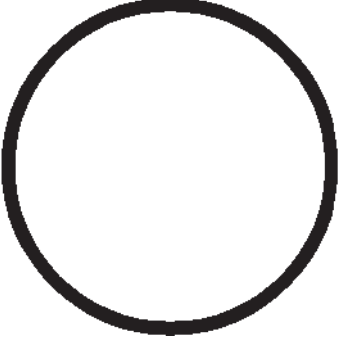
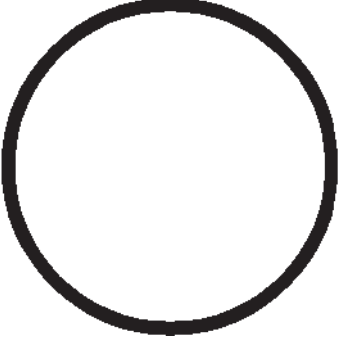
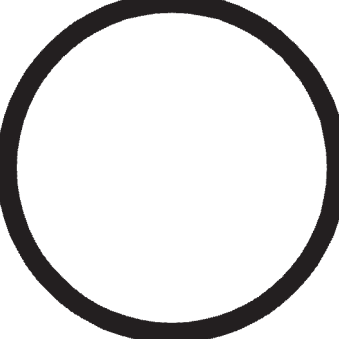
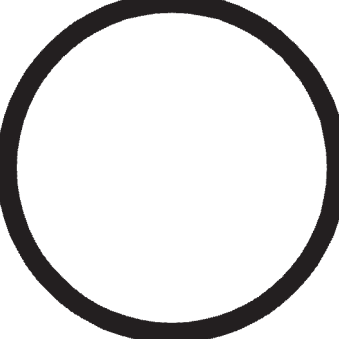
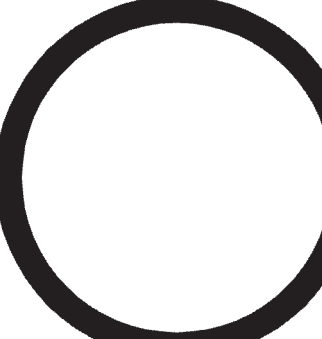
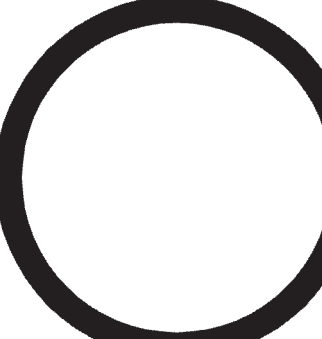
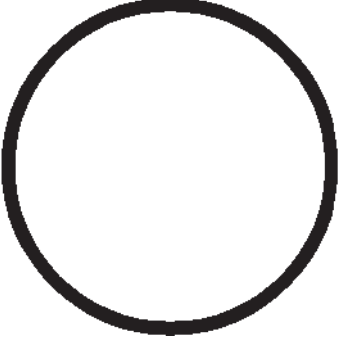
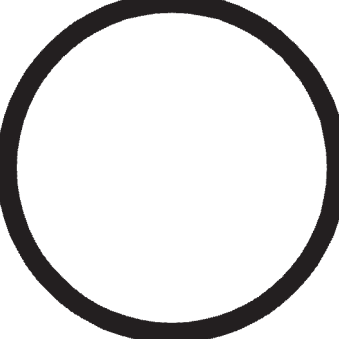
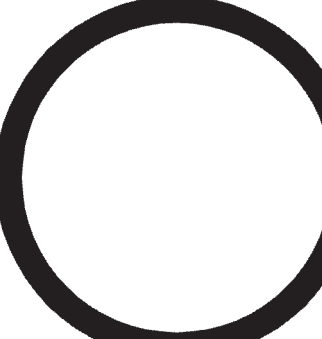
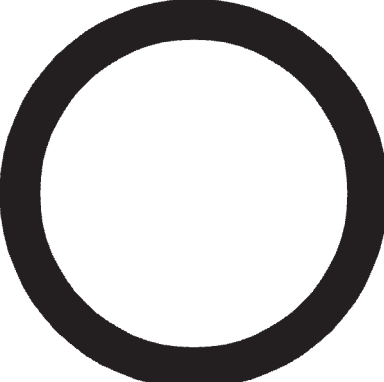
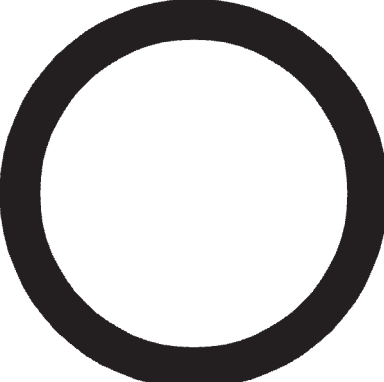
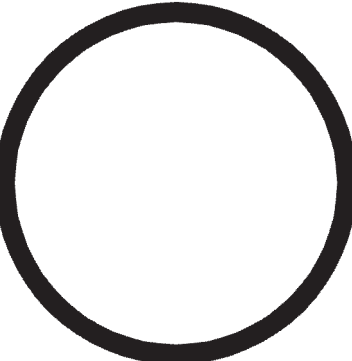
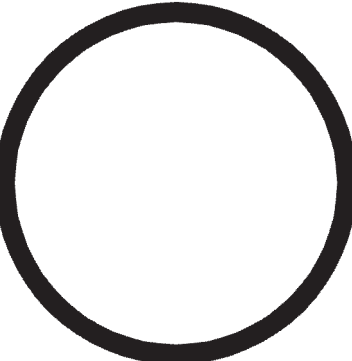
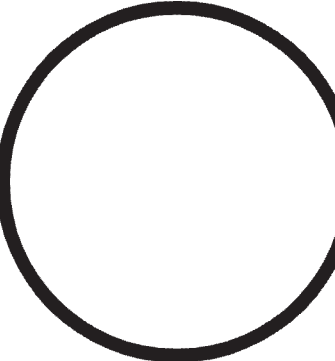
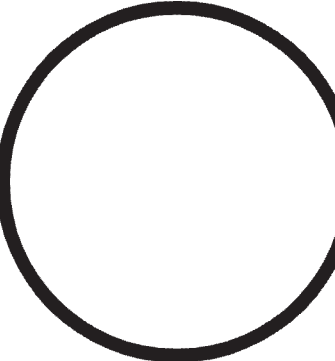
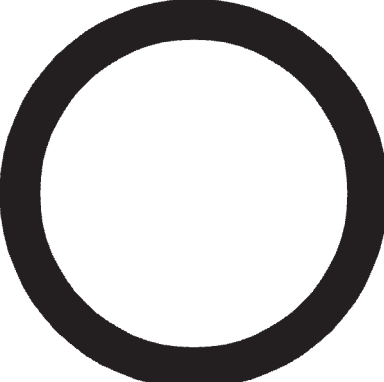
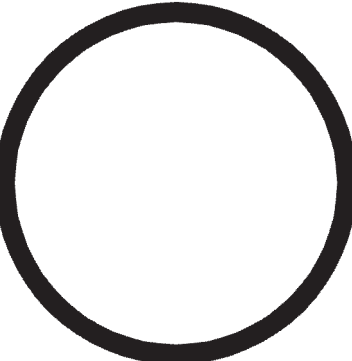
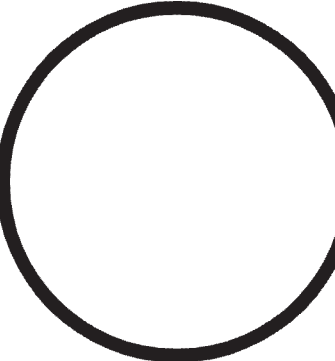
# O-RINGS

<table style="width: 100%; border-collapse: collapse;"> <thead> <tr> <th style="text-align: left;">DANCO #</th> <th style="text-align: left;">KIRK #</th> <th style="text-align: left;">P&amp;M #</th> </tr> </thead> <tbody> <tr> <td>I.D. 1-1/2 1.484</td> <td>O.D. 1-3/4 1.762</td> <td>THICK 1/8 0.139</td> </tr> <tr> <td colspan="3" style="text-align: center;">  </td> </tr> <tr> <td colspan="3" style="text-align: center;">Price Pfister Genesis Spout (PP950-910)</td> </tr> <tr> <td colspan="2">LASCO# <b>02-1618</b></td> <td style="text-align: right;"><b>81</b></td> </tr> </tbody> </table>	DANCO #	KIRK #	P&M #	I.D. 1-1/2 1.484	O.D. 1-3/4 1.762	THICK 1/8 0.139				Price Pfister Genesis Spout (PP950-910)			LASCO# <b>02-1618</b>		<b>81</b>	<table style="width: 100%; border-collapse: collapse;"> <thead> <tr> <th style="text-align: left;">DANCO #</th> <th style="text-align: left;">KIRK #</th> <th style="text-align: left;">P&amp;M #</th> </tr> </thead> <tbody> <tr> <td><b>35752</b></td> <td></td> <td><b>14625</b></td> </tr> <tr> <td>I.D. 1-9/16 1.549</td> <td>O.D. 1-3/4 1.755</td> <td>THICK 3/32 0.103</td> </tr> <tr> <td colspan="3" style="text-align: center;">  </td> </tr> <tr> <td colspan="3" style="text-align: center;">Spouts-Valley O/S, Nibco, Nile, Peerless, Price Pfister, Union Brass S/L Cartridge</td> </tr> <tr> <td colspan="2">LASCO# <b>02-1584</b></td> <td style="text-align: right;"><b>83</b></td> </tr> </tbody> </table>	DANCO #	KIRK #	P&M #	<b>35752</b>		<b>14625</b>	I.D. 1-9/16 1.549	O.D. 1-3/4 1.755	THICK 3/32 0.103				Spouts-Valley O/S, Nibco, Nile, Peerless, Price Pfister, Union Brass S/L Cartridge			LASCO# <b>02-1584</b>		<b>83</b>	<table style="width: 100%; border-collapse: collapse;"> <thead> <tr> <th style="text-align: left;">DANCO #</th> <th style="text-align: left;">KIRK #</th> <th style="text-align: left;">P&amp;M #</th> </tr> </thead> <tbody> <tr> <td>I.D. 1-9/16 1.549</td> <td>O.D. 1-3/4 1.755</td> <td>THICK Quad</td> </tr> <tr> <td colspan="3" style="text-align: center;">  </td> </tr> <tr> <td colspan="3" style="text-align: center;">Price Pfister Genesis Spout (PP950-910)</td> </tr> <tr> <td colspan="2">LASCO# <b>02-7188</b></td> <td style="text-align: right;"><b>83Q</b></td> </tr> </tbody> </table>	DANCO #	KIRK #	P&M #	I.D. 1-9/16 1.549	O.D. 1-3/4 1.755	THICK Quad				Price Pfister Genesis Spout (PP950-910)			LASCO# <b>02-7188</b>		<b>83Q</b>						
DANCO #	KIRK #	P&M #																																																						
I.D. 1-1/2 1.484	O.D. 1-3/4 1.762	THICK 1/8 0.139																																																						
																																																								
Price Pfister Genesis Spout (PP950-910)																																																								
LASCO# <b>02-1618</b>		<b>81</b>																																																						
DANCO #	KIRK #	P&M #																																																						
<b>35752</b>		<b>14625</b>																																																						
I.D. 1-9/16 1.549	O.D. 1-3/4 1.755	THICK 3/32 0.103																																																						
																																																								
Spouts-Valley O/S, Nibco, Nile, Peerless, Price Pfister, Union Brass S/L Cartridge																																																								
LASCO# <b>02-1584</b>		<b>83</b>																																																						
DANCO #	KIRK #	P&M #																																																						
I.D. 1-9/16 1.549	O.D. 1-3/4 1.755	THICK Quad																																																						
																																																								
Price Pfister Genesis Spout (PP950-910)																																																								
LASCO# <b>02-7188</b>		<b>83Q</b>																																																						
<table style="width: 100%; border-collapse: collapse;"> <thead> <tr> <th style="text-align: left;">DANCO #</th> <th style="text-align: left;">KIRK #</th> <th style="text-align: left;">P&amp;M #</th> </tr> </thead> <tbody> <tr> <td><b>35766</b></td> <td><b>R-76</b></td> <td><b>14528</b></td> </tr> <tr> <td>I.D. 1-5/8 1.614</td> <td>O.D. 1-3/4 1.754</td> <td>THICK 1/16 0.070</td> </tr> <tr> <td colspan="3" style="text-align: center;">  </td> </tr> <tr> <td colspan="3" style="text-align: center;">Union Brass Spout</td> </tr> <tr> <td colspan="2">LASCO# <b>02-1572</b></td> <td style="text-align: right;"><b>85</b></td> </tr> </tbody> </table>	DANCO #	KIRK #	P&M #	<b>35766</b>	<b>R-76</b>	<b>14528</b>	I.D. 1-5/8 1.614	O.D. 1-3/4 1.754	THICK 1/16 0.070				Union Brass Spout			LASCO# <b>02-1572</b>		<b>85</b>	<table style="width: 100%; border-collapse: collapse;"> <thead> <tr> <th style="text-align: left;">DANCO #</th> <th style="text-align: left;">KIRK #</th> <th style="text-align: left;">P&amp;M #</th> </tr> </thead> <tbody> <tr> <td><b>35763</b></td> <td></td> <td><b>14626</b></td> </tr> <tr> <td>I.D. 1-5/8 1.612</td> <td>O.D. 1-3/4 1.818</td> <td>THICK 3/32 0.103</td> </tr> <tr> <td colspan="3" style="text-align: center;">  </td> </tr> <tr> <td colspan="3" style="text-align: center;">Sloan</td> </tr> <tr> <td colspan="2">LASCO# <b>02-1460</b></td> <td style="text-align: right;"><b>86</b></td> </tr> </tbody> </table>	DANCO #	KIRK #	P&M #	<b>35763</b>		<b>14626</b>	I.D. 1-5/8 1.612	O.D. 1-3/4 1.818	THICK 3/32 0.103				Sloan			LASCO# <b>02-1460</b>		<b>86</b>	<table style="width: 100%; border-collapse: collapse;"> <thead> <tr> <th style="text-align: left;">DANCO #</th> <th style="text-align: left;">KIRK #</th> <th style="text-align: left;">P&amp;M #</th> </tr> </thead> <tbody> <tr> <td><b>35763</b></td> <td></td> <td><b>14663</b></td> </tr> <tr> <td>I.D. 1-5/8 1.609</td> <td>O.D. 1-7/8 1.887</td> <td>THICK 1/8 0.139</td> </tr> <tr> <td colspan="3" style="text-align: center;">  </td> </tr> <tr> <td colspan="3" style="text-align: center;">Elkay Spout, Premier Romon Tub</td> </tr> <tr> <td colspan="2">LASCO# <b>02-1488</b></td> <td style="text-align: right;"><b>87</b></td> </tr> </tbody> </table>	DANCO #	KIRK #	P&M #	<b>35763</b>		<b>14663</b>	I.D. 1-5/8 1.609	O.D. 1-7/8 1.887	THICK 1/8 0.139				Elkay Spout, Premier Romon Tub			LASCO# <b>02-1488</b>		<b>87</b>
DANCO #	KIRK #	P&M #																																																						
<b>35766</b>	<b>R-76</b>	<b>14528</b>																																																						
I.D. 1-5/8 1.614	O.D. 1-3/4 1.754	THICK 1/16 0.070																																																						
																																																								
Union Brass Spout																																																								
LASCO# <b>02-1572</b>		<b>85</b>																																																						
DANCO #	KIRK #	P&M #																																																						
<b>35763</b>		<b>14626</b>																																																						
I.D. 1-5/8 1.612	O.D. 1-3/4 1.818	THICK 3/32 0.103																																																						
																																																								
Sloan																																																								
LASCO# <b>02-1460</b>		<b>86</b>																																																						
DANCO #	KIRK #	P&M #																																																						
<b>35763</b>		<b>14663</b>																																																						
I.D. 1-5/8 1.609	O.D. 1-7/8 1.887	THICK 1/8 0.139																																																						
																																																								
Elkay Spout, Premier Romon Tub																																																								
LASCO# <b>02-1488</b>		<b>87</b>																																																						
<table style="width: 100%; border-collapse: collapse;"> <thead> <tr> <th style="text-align: left;">DANCO #</th> <th style="text-align: left;">KIRK #</th> <th style="text-align: left;">P&amp;M #</th> </tr> </thead> <tbody> <tr> <td></td> <td></td> <td><b>14678</b></td> </tr> <tr> <td>I.D. 1-5/8 1.600</td> <td>O.D. 2" 2.020</td> <td>THICK 3/16 0.210</td> </tr> <tr> <td colspan="3" style="text-align: center;">  </td> </tr> <tr> <td colspan="3" style="text-align: center;">Various</td> </tr> <tr> <td colspan="2">LASCO# <b>02-1464</b></td> <td style="text-align: right;"><b>88</b></td> </tr> </tbody> </table>	DANCO #	KIRK #	P&M #			<b>14678</b>	I.D. 1-5/8 1.600	O.D. 2" 2.020	THICK 3/16 0.210				Various			LASCO# <b>02-1464</b>		<b>88</b>	<table style="width: 100%; border-collapse: collapse;"> <thead> <tr> <th style="text-align: left;">DANCO #</th> <th style="text-align: left;">KIRK #</th> <th style="text-align: left;">P&amp;M #</th> </tr> </thead> <tbody> <tr> <td></td> <td></td> <td><b>14627</b></td> </tr> <tr> <td>I.D. 1-11/16 1.674</td> <td>O.D. 1-7/8 1.880</td> <td>THICK 3/32 0.103</td> </tr> <tr> <td colspan="3" style="text-align: center;">  </td> </tr> <tr> <td colspan="3" style="text-align: center;">Union Brass Spout</td> </tr> <tr> <td colspan="2">LASCO# <b>02-1462</b></td> <td style="text-align: right;"><b>90</b></td> </tr> </tbody> </table>	DANCO #	KIRK #	P&M #			<b>14627</b>	I.D. 1-11/16 1.674	O.D. 1-7/8 1.880	THICK 3/32 0.103				Union Brass Spout			LASCO# <b>02-1462</b>		<b>90</b>	<table style="width: 100%; border-collapse: collapse;"> <thead> <tr> <th style="text-align: left;">DANCO #</th> <th style="text-align: left;">KIRK #</th> <th style="text-align: left;">P&amp;M #</th> </tr> </thead> <tbody> <tr> <td><b>35779</b></td> <td></td> <td><b>14529</b></td> </tr> <tr> <td>I.D. 1-3/4 1.739</td> <td>O.D. 1-7/8 1.879</td> <td>THICK 1/16 0.070</td> </tr> <tr> <td colspan="3" style="text-align: center;">  </td> </tr> <tr> <td colspan="3" style="text-align: center;">Powers, Case 62</td> </tr> <tr> <td colspan="2">LASCO# <b>02-1438</b></td> <td style="text-align: right;"><b>92</b></td> </tr> </tbody> </table>	DANCO #	KIRK #	P&M #	<b>35779</b>		<b>14529</b>	I.D. 1-3/4 1.739	O.D. 1-7/8 1.879	THICK 1/16 0.070				Powers, Case 62			LASCO# <b>02-1438</b>		<b>92</b>
DANCO #	KIRK #	P&M #																																																						
		<b>14678</b>																																																						
I.D. 1-5/8 1.600	O.D. 2" 2.020	THICK 3/16 0.210																																																						
																																																								
Various																																																								
LASCO# <b>02-1464</b>		<b>88</b>																																																						
DANCO #	KIRK #	P&M #																																																						
		<b>14627</b>																																																						
I.D. 1-11/16 1.674	O.D. 1-7/8 1.880	THICK 3/32 0.103																																																						
																																																								
Union Brass Spout																																																								
LASCO# <b>02-1462</b>		<b>90</b>																																																						
DANCO #	KIRK #	P&M #																																																						
<b>35779</b>		<b>14529</b>																																																						
I.D. 1-3/4 1.739	O.D. 1-7/8 1.879	THICK 1/16 0.070																																																						
																																																								
Powers, Case 62																																																								
LASCO# <b>02-1438</b>		<b>92</b>																																																						

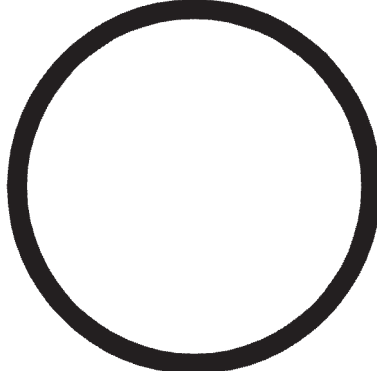
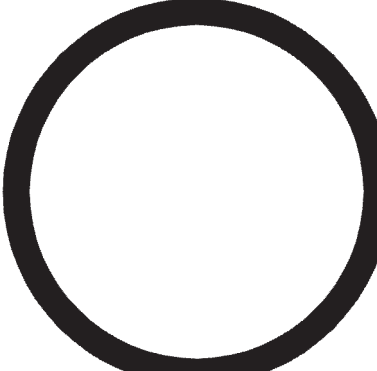
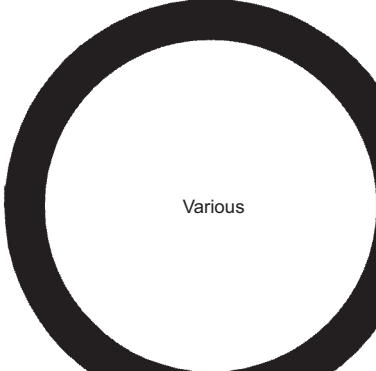
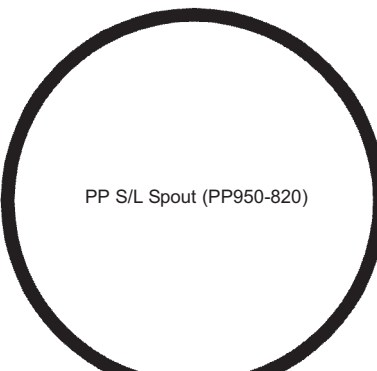
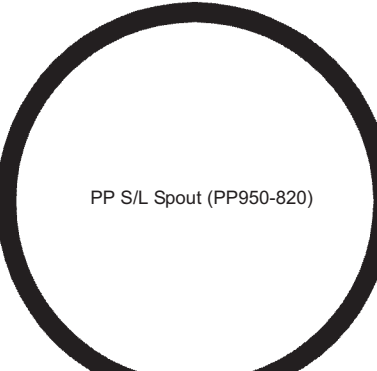
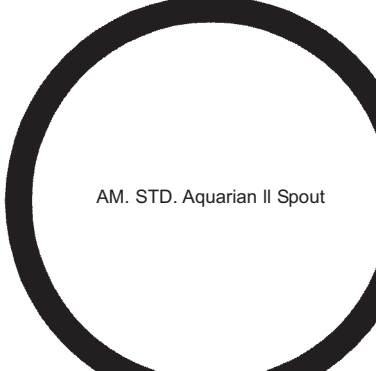

# O-RINGS

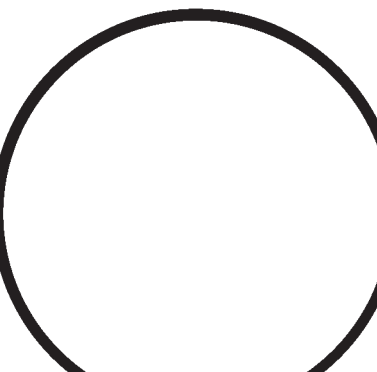
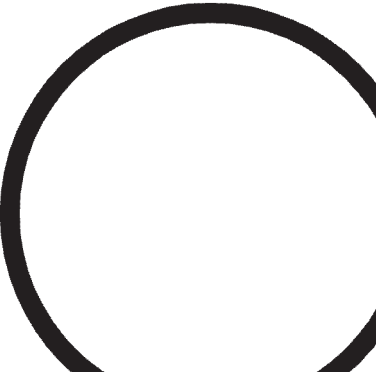
DANCO #	KIRK #	P&M #	DANCO #	KIRK #	P&M #	DANCO #	KIRK #	P&M #
		<b>14629</b>			<b>14677</b>			
I.D. 1-3/4 1.737	O.D. 1-15/16 1.943	THICK 3/32 0.103	I.D. 1-3/4 1.734	O.D. 2" 2.012	THICK 1/8 0.139	I.D. 1-3/4 1.725	O.D. 2-1/8 2.145	THICK 3/16 0.210
								
Price Pfister Flowmatic Spout (PP949-130), Sterling S/L Mix Cartridge			Union Brass S/L T&S Cartridge, Powers			Various		
LASCO# <b>02-1590</b> <b>93</b>			LASCO# <b>02-1490</b> <b>94</b>			LASCO# <b>02-1466</b> <b>95</b>		
		<b>R-84</b>			<b>R-85</b>			<b>14696</b>
I.D. 1-7/8 1.864	O.D. 2" 2.004	THICK 1/16 0.070	I.D. 1-7/8 1.862	O.D. 2-1/16 2.068	THICK 3/32 0.103	I.D. 1-7/8 1.859	O.D. 2-1/8 2.137	THICK 1/8 0.139
								
PP S/L Spout (PP950-820)			PP S/L Spout (PP950-820)			AM. STD. Aquarian II Spout		
LASCO# <b>02-1622</b> <b>96</b>			LASCO# <b>02-1600</b> <b>97</b>			LASCO# <b>02-1492</b> <b>98</b>		
		<b>14689</b>						
I.D. 48mm	O.D. 54mm	THICK 3mm	I.D. 2" 2.020	O.D. 2-1/8 2.137	THICK 1/16 0.070	I.D. 2" 1.987	O.D. 2-3/16 2.193	THICK 3/32 0.103
								
AM. STD. Aquarian II Version 2								
LASCO# <b>02-1598</b> <b>101</b>			LASCO# <b>Special Order (033)</b> <b>102</b>			LASCO# <b>02-1574</b> <b>103</b>		

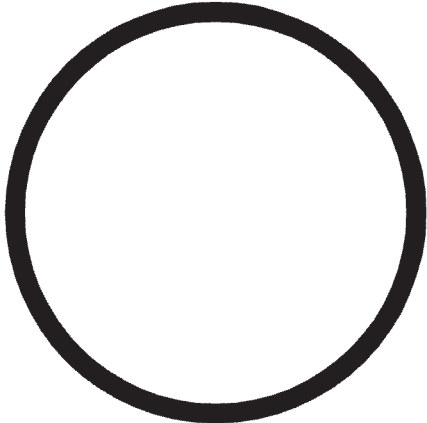
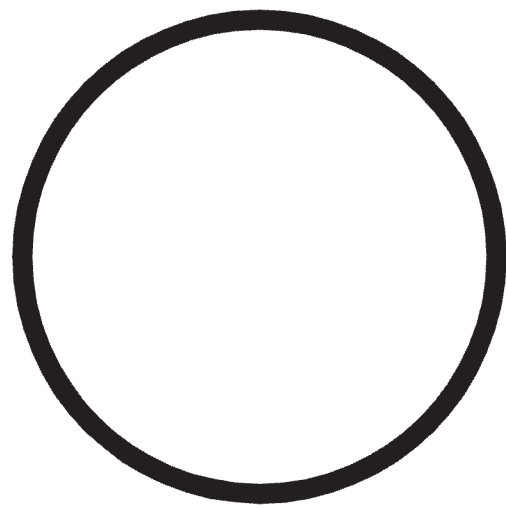
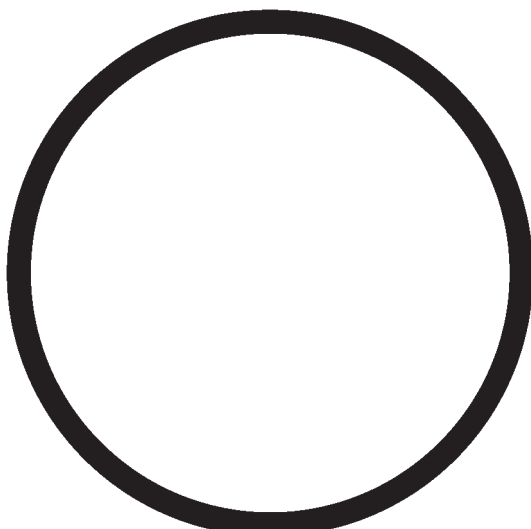
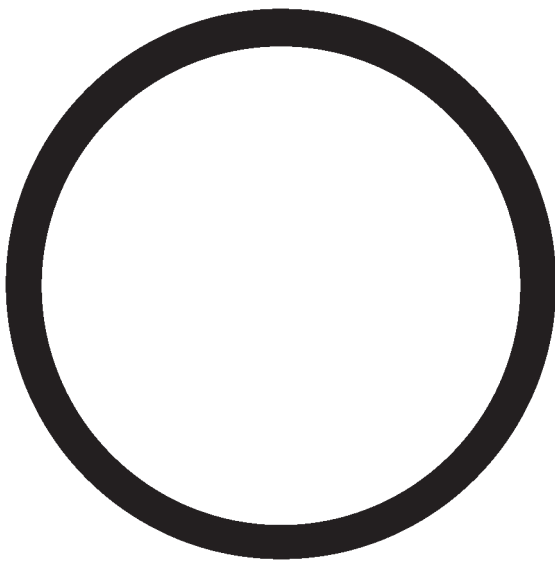

# O-RINGS

DANCO #	KIRK #	P&M #	DANCO #	KIRK #	P&M #
I.D. 2" 1.987	O.D. 2-3/16 2.193	<b>18161</b> THICK 3/32 Quad 0.103	I.D. 2-3/8 2.362	O.D. 2-9/16 2.568	THICK 3/32 0.103
					
American Standard Quad Ring					
LASCO# <b>02-1592</b>		<b>106</b>	LASCO# <b>02-1608</b>		<b>112</b>
DANCO #	KIRK #	P&M #	DANCO #	KIRK #	P&M #
I.D. 2-1/2	O.D. 2-3/4	THICK 1/8	I.D. 2-1/2	O.D. 2-7/8	THICK 3/16
					
LASCO# <b>02-7200</b>		<b>113</b>	LASCO# <b>02-7250</b>		<b>114</b>

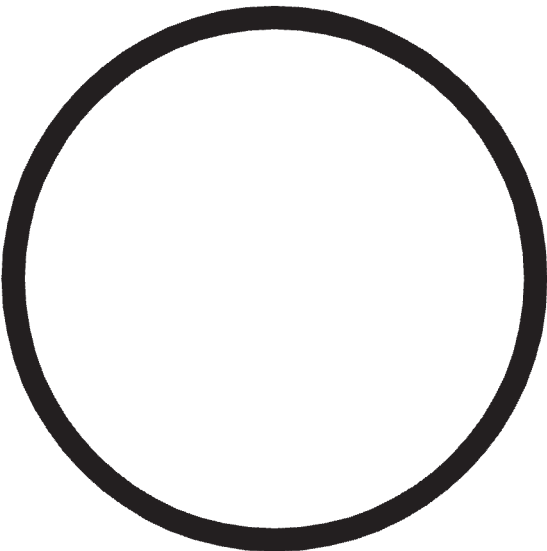
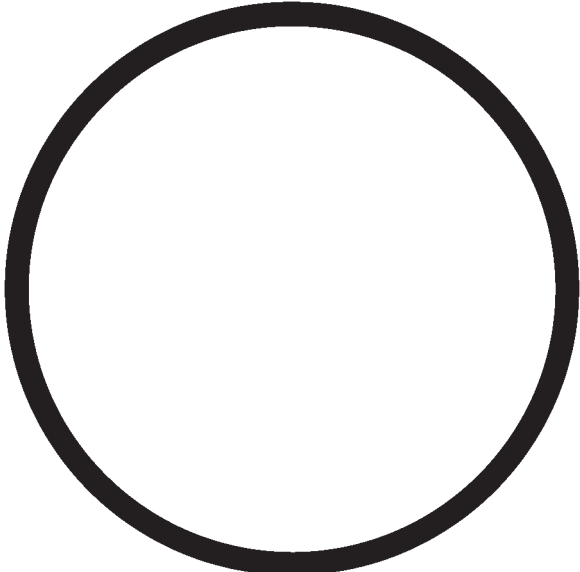
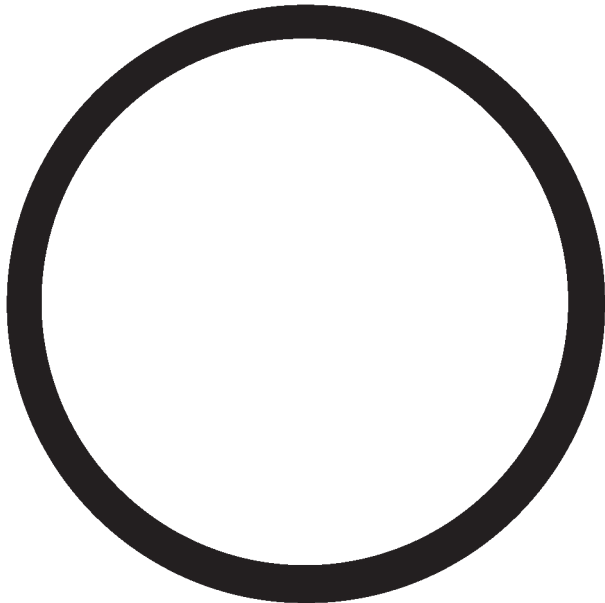
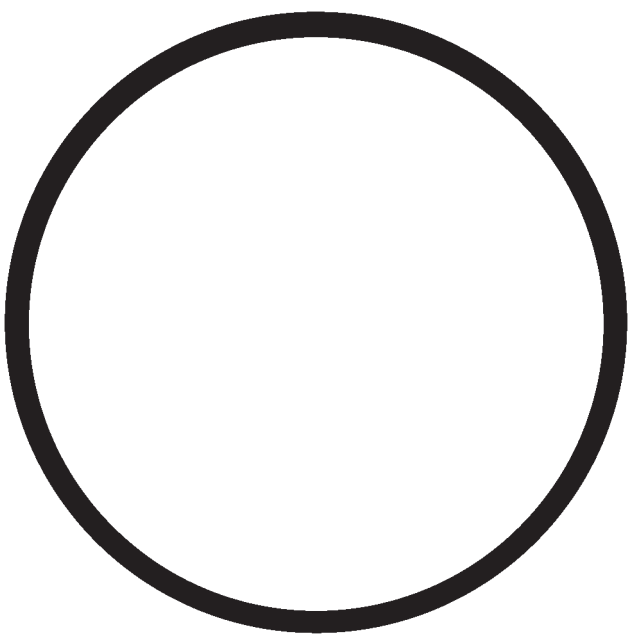

# O-RINGS

DANCO #	KIRK #	P&M #	DANCO #	KIRK #	P&M #
I.D. 2-5/8 2.600	O.D. 2-7/8 2.840	THICK 1/8 0.139	I.D. 2-3/4	O.D. 3"	THICK 1/8
					
LASCO# 02-1610			LASCO# 02-7204		
115			117		
DANCO #	KIRK #	P&M #	DANCO #	KIRK #	P&M #
I.D. 2-3/4	O.D. 3-1/8	THICK 3/16	I.D. 3"	O.D. 3-1/4	THICK 1/8
					
LASCO# 02-7254			LASCO# 02-7208		
118			120		

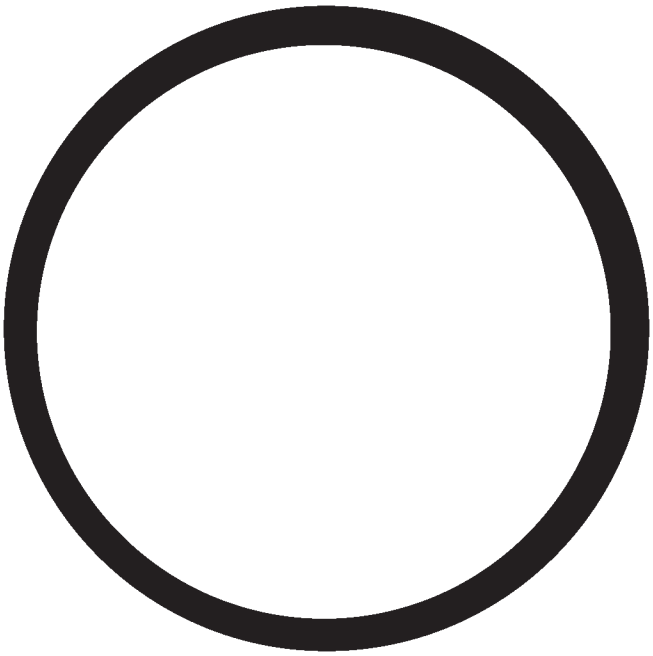
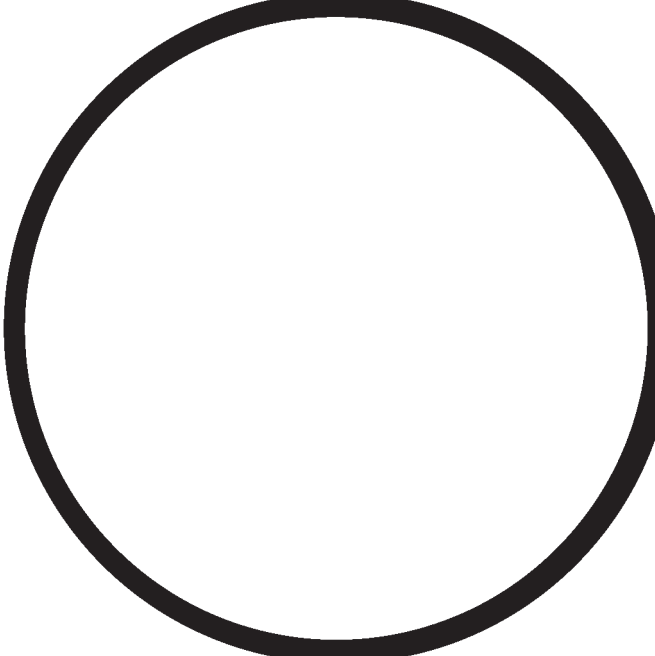
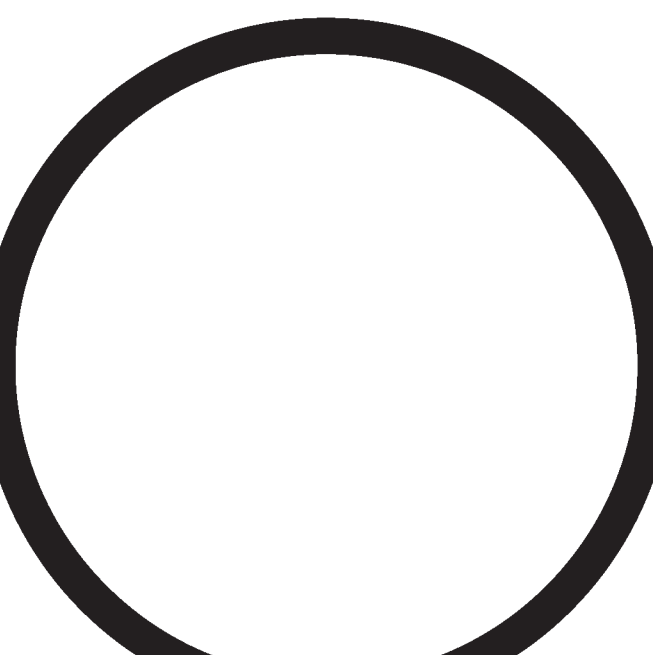
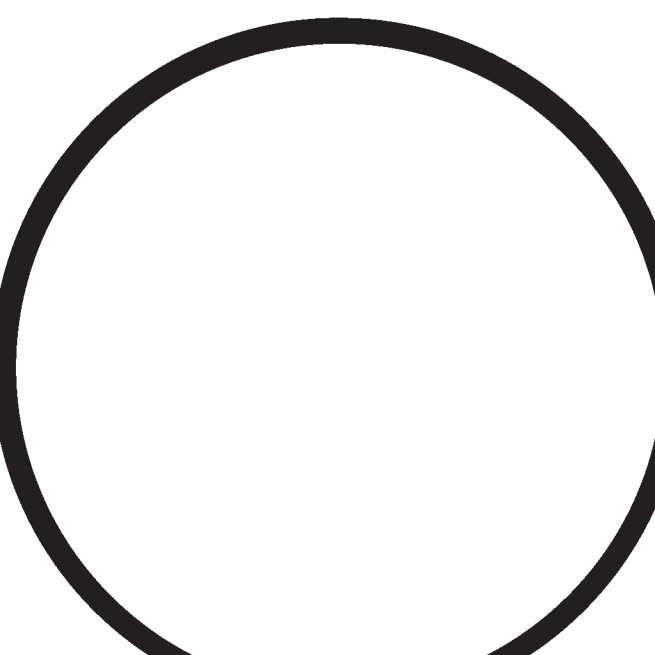

# O-RINGS

DANCO #	KIRK #	P&M #	DANCO #	KIRK #	P&M #
I.D. 3"	O.D. 3-3/8	THICK 3/16	I.D. 3-1/4	O.D. 3-1/2	THICK 1/8
					
LASCO# <b>02-7258</b>			LASCO# <b>02-7212</b>		
121			123		
DANCO #	KIRK #	P&M #	DANCO #	KIRK #	P&M #
I.D. 3-1/4	O.D. 3-5/8	THICK 3/16	I.D. 3-3/8	O.D. 3-5/8	THICK 1/8
					
LASCO# <b>02-7262</b>			LASCO# <b>02-7214</b>		
124			126		

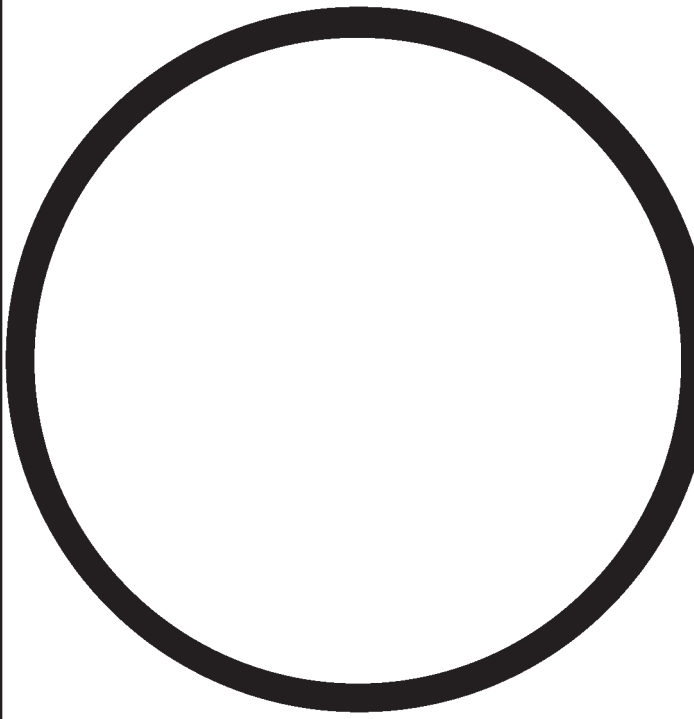
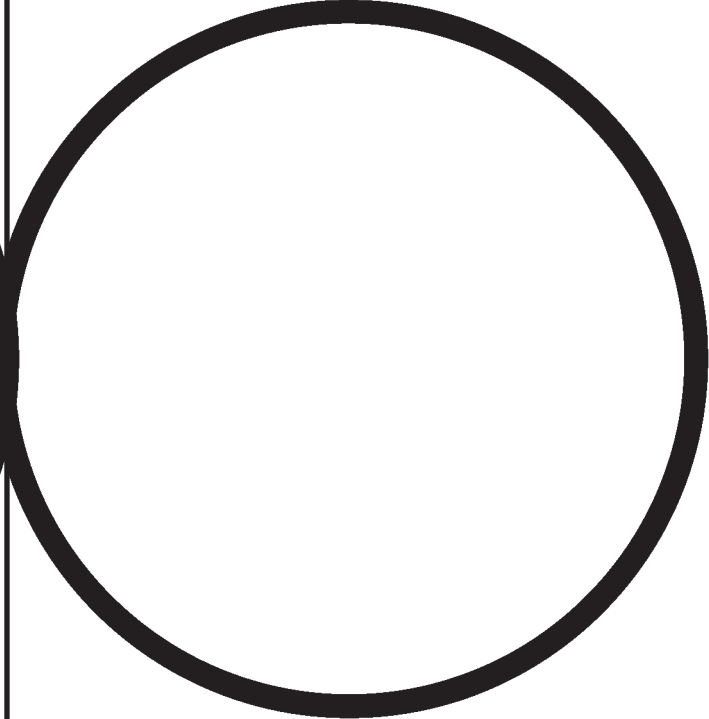
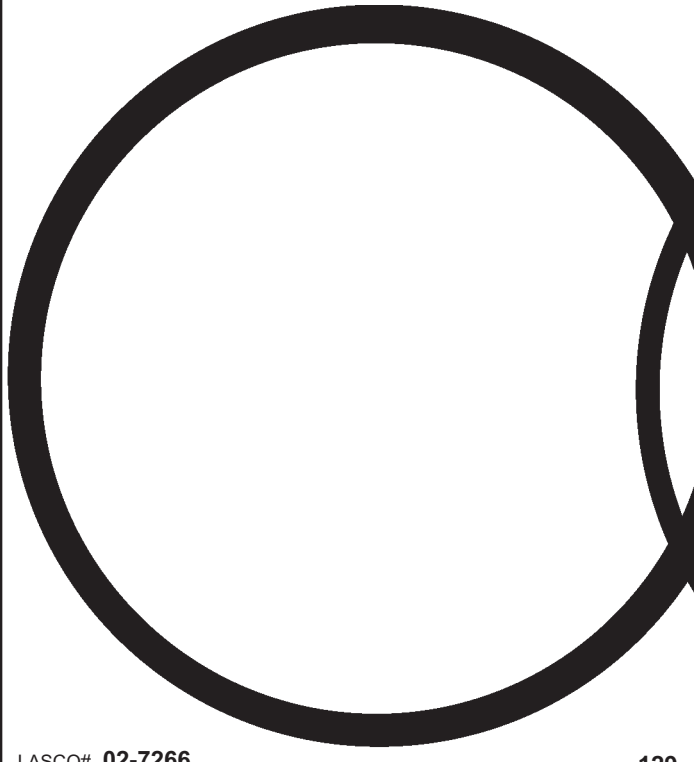
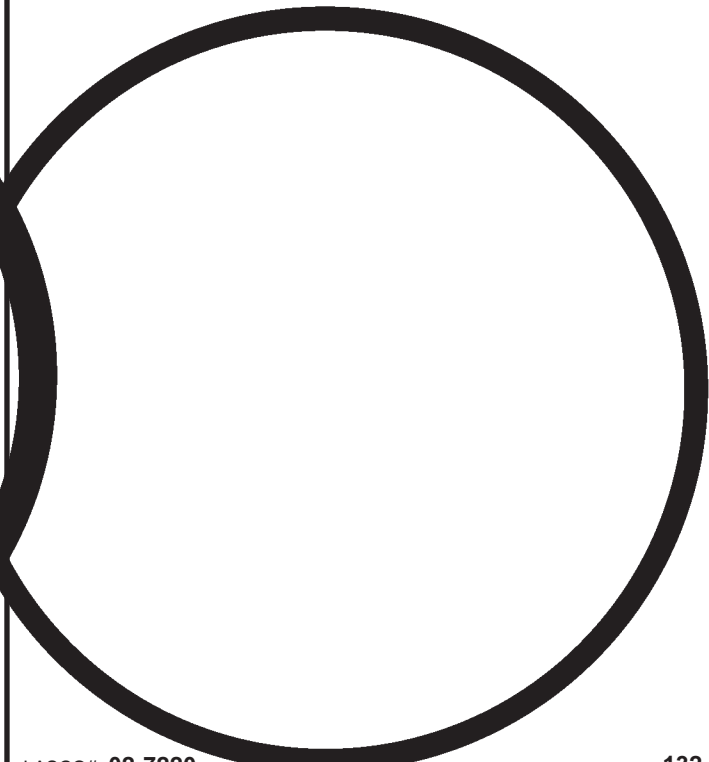

# O-RINGS

DANCO #	KIRK #	P&M #	DANCO #	KIRK #	P&M #
I.D. 3-3/8	O.D. 3-11/16	THICK 5/32	I.D. 3-1/2	O.D. 3-3/4	THICK 1/8
					
LASCO# 02-7234			LASCO# 02-7216		
127			128		
DANCO #	KIRK #	P&M #	DANCO #	KIRK #	P&M #
I.D. 3-1/2	O.D. 3-7/8	THICK 3/16	I.D. 3-3/4	O.D. 4"	THICK 1/8
					
LASCO# 02-7266			LASCO# 02-7220		
129			132		





# O-RINGS

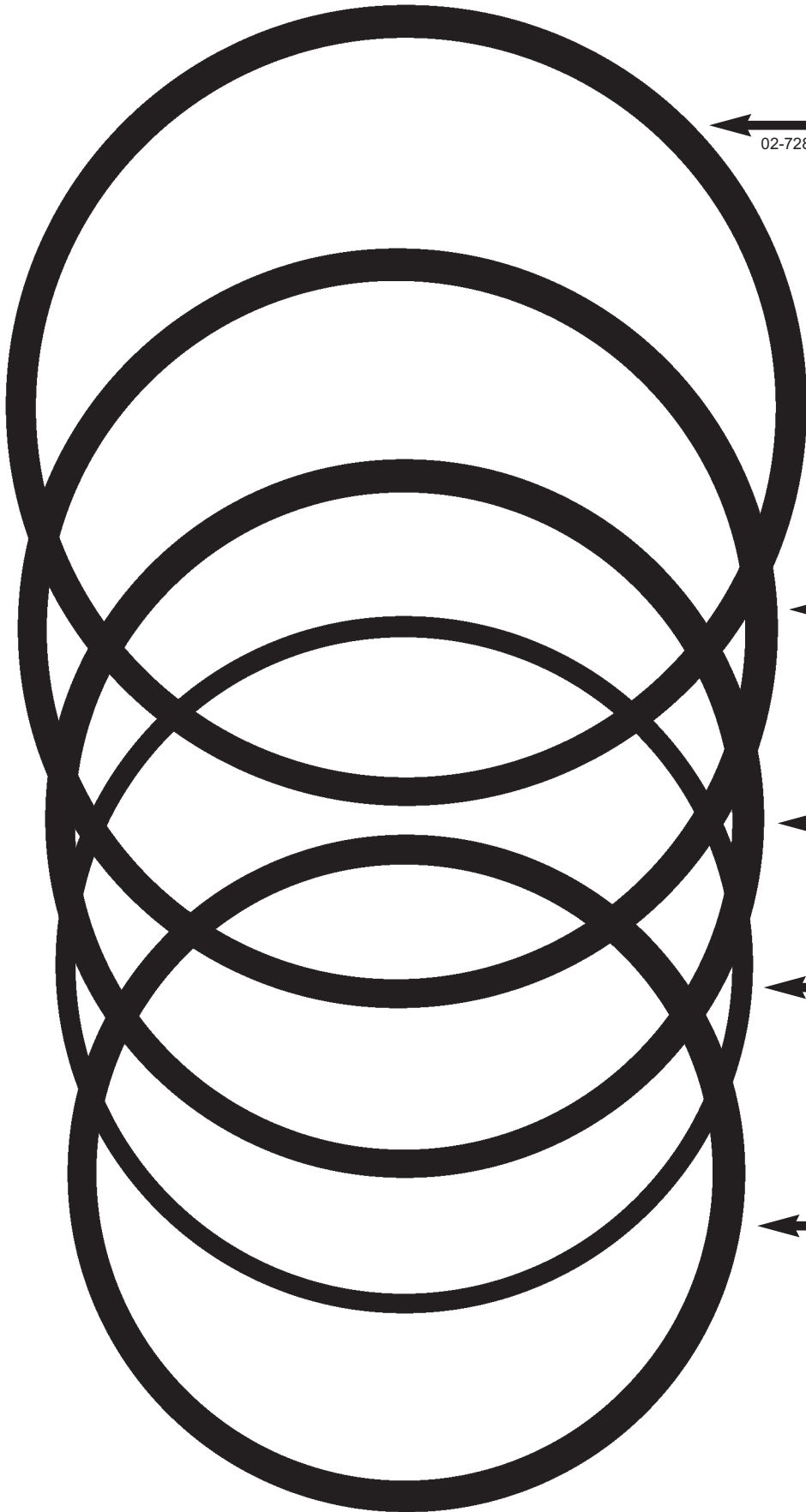

← 02-7282 POP #144

I.D.	O.D.	THICK
4-1/2	4-7/8	3/16

← 02-7278 POP #140

I.D.	O.D.	THICK
4-1/4	4-5/8	3/16

← 02-7274 POP #137

I.D.	O.D.	THICK
4"	4-3/8	3/16

← 02-7224 POP #136

I.D.	O.D.	THICK
4"	4-1/4	1/8

← 02-7270 POP #133

I.D.	O.D.	THICK
3-3/4	4-1/8	3/16



# O-RINGS

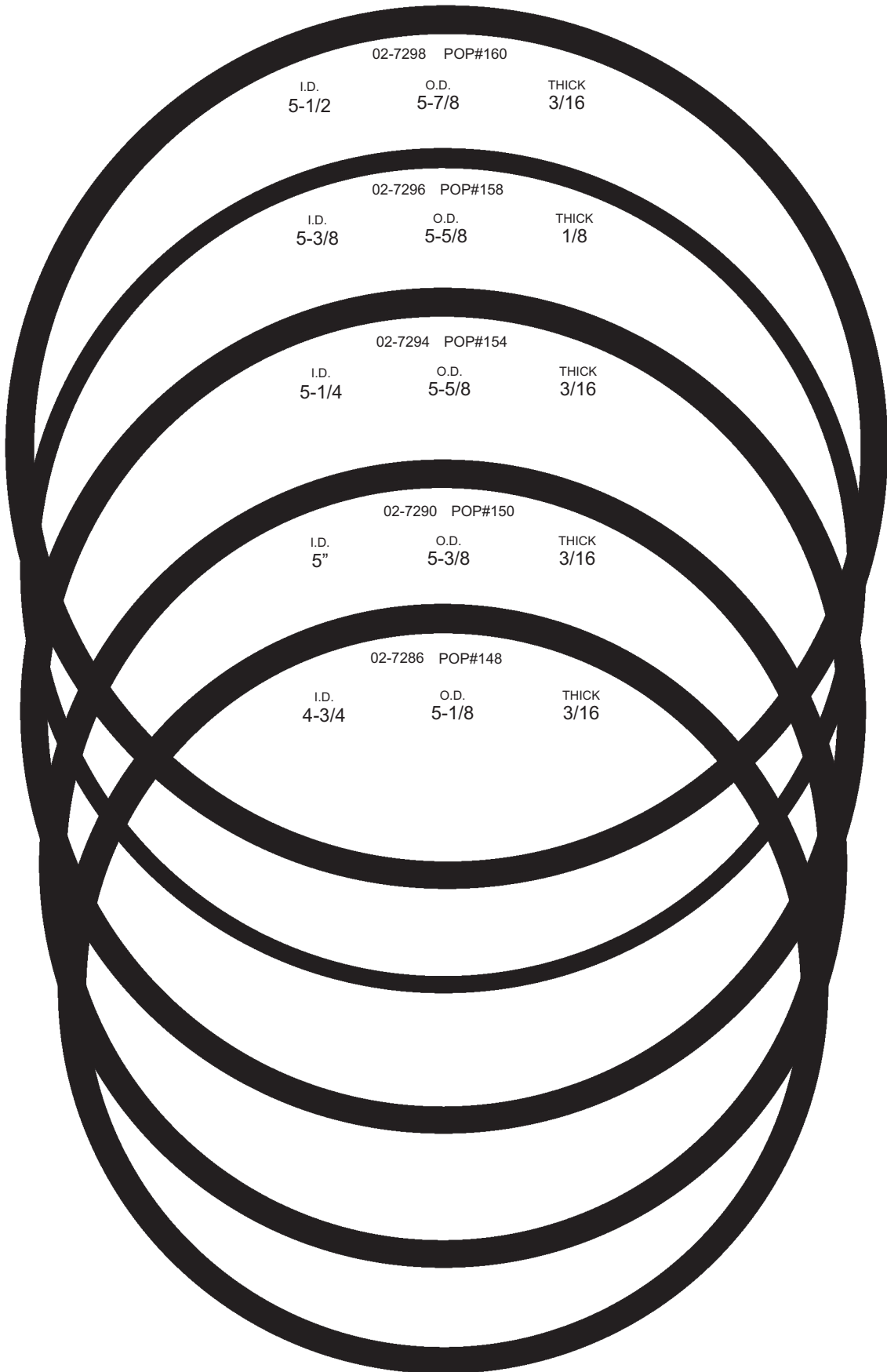

# SQUARE CUT PACKING CHART

## Graphite, Teflon, Rubber and Cork

POP	I.D.	O.D.	THICK	MAT.	BULK	CTN.	POLY BAG 12/BAG	CTN.	UPC BAG 1/BAG	CTN.	CARD 2/CARD	CTN.
1	5/16	9/16	5/16	T	02-1700	100	02-1700D	1	02-1700P	10	02-1701	6
2	3/8	17/32	1/4	T	02-1702	100	02-1702D	1	02-1700P	10	02-1703	6
3	3/8	9/16	1/4	R	02-1786	100	02-1786D	1	02-1786P	10	02-1787	6
4	3/8	9/16	3/16	G	02-1648	100	02-1648D	1	02-1648P	10	02-1649	6
5	3/8	21/32	3/8	T	02-1708	100	02-1708D	1	02-1708P	10	02-1709	6
5A	3/8	5/8	7/32	G	06-9980	100						
6	3/8	3/4	3/16	G	02-1772	100	02-1772D	1	02-1772P	10	02-1773	6
7	3/8	3/4	5/16	T	02-1720	100	02-1720D	1	02-1720P	10	02-1721	6
8	3/8	5/8	3/16	R	02-1680	100	02-1680D	1	02-1680P	10	02-1681	6
9	13/32	9/16	3/8	T	02-1718	100	02-1718D	1	02-1718P	10	02-1719	6
10	13/32	11/16	5/16	T	02-1722	100	02-1722D	1	02-1722P	10	02-1723	6
11	7/16	5/8	5/16	T	02-1724	100	02-1724D	1	02-1724P	10	02-1725	6
12	7/16	21/32	1/4	R	02-1694	100	02-1694D	1	02-1694P	10	02-1695	6
13	7/16	21/32	5/16	T	02-1726	100	02-1726D	1	02-1726P	10	02-1727	6
14	7/16	11/16	1/4	R	02-7010	100					02-7011	6
15	7/16	11/16	5/16	T	02-1728	100	02-1728D	1	02-1728P	10	02-1729	6
16	7/16	3/4	5/16	G	02-1730	100	02-1730D	1	02-1730P	10	02-1731	6
19	7/16	25/32	1/4	T	02-1734	100	02-1734D	1	02-1734P	10	02-1735	6
20	7/16	7/8	5/16	T	02-1736	100	02-1736D	1	02-1736P	10	02-1737	6
21	15/32	5/8	5/16	G	02-1640	100	02-1640D	1	02-1640P	10	02-1641	6
22	15/32	7/8	5/16	G	02-1738	100	02-1738D	1	02-1738P	10	02-1739	6
23	1/2	13/16	5/16	T	02-1742	100			02-1742P	10	02-1473	6
24	1/2	29/32	15/32	T	02-1746	100			02-1746P	10	02-1747	6
25	19/32	25/32	11/32	T	02-1744	100			02-1744P	10	02-1745	6
26	19/32	29/32	1/2	R	02-7012	100						
26A	19/32	7/8	5/32	R	02-7190	100						
27	5/8	3/4	9/32	R	02-1690	100	02-1690D	1	02-1690P	10	02-1691	6
28	5/8	27/32	7/32	R	02-1692	100			02-1692P	10	02-1693	6
29	5/8	7/8	1/4	G	02-1684	100			02-1684P	10	02-1685	6
30	11/16	7/8	5/16	G	02-1770	100			02-1770P	10	02-1771	6
31	11/16	7/8	1/16	G	02-7006	100	02-7006D	1	02-7006P	10	02-7007	6
32	11/16	7/8	3/16	G	02-1652	100			02-1652P	10	02-1653	6
33	3/4	7/8	5/16	T	02-1696	100			02-1696P	10	02-1697	6
34	3/4	7/8	5/16	R	02-1782	100	02-1782D	1	02-1782P	10	02-1783	6
35	3/4	15/16	3/8	G	02-1686	100			02-1686P	10	02-1687	6
36	3/4	1"	1/4	G	02-1688	100			02-1688P	10	02-1689	6
37	25/32	1-1/16	7/32	G	02-1774	100			02-1774P	10	02-1775	6
38	13/16	1-1/16	1/16	C	02-7008	100	02-7008D	1	02-7008P	10	02-7009	6
39	13/16	1-1/8	1/8	C	02-1760	100	02-1760D	1	02-1760P	10	02-1761	6
40	7/8	1"	1/4	G	02-1666	100	02-1666D	1	02-1666P	10	02-1667	6
41	7/8	1-5/32	3/16	G	02-1650	100	02-1650D	1	02-1650P	10		
42	1"	1-1/4	1/8	G	02-1790	100	02-1790D	1	02-1790P	10	02-1791	6
43	15/16	1-1/32	1/8	R	02-1656	100			02-1656P	10		



**MATERIAL**

**G = Graphite**

**T = Teflon**

**R = Rubber**

**C = Cork**



# SQUARE CUT PACKING WASHERS

## CLOTH INSERTED RUBBER

POP	I.D.	O.D.	THICK	BULK	CTN.	POLY BAG 12/BAG	CTN.	UPC BAG 1/BAG	CTN.	CARD 2/CARD	CTN.
<u>A</u>	<u>5/16</u>	<u>5/8</u>	<u>7/32</u>	<u>02-1636</u>	<u>100</u>	<u>02-1636D</u>	<u>1</u>	<u>02-1636P</u>	<u>10</u>	<u>02-1637</u>	<u>6</u>
<u>B</u>	<u>3/8</u>	<u>9/16</u>	<u>1/4</u>	<u>02-7000</u>	<u>100</u>	<u>02-7000D</u>	<u>1</u>	<u>02-7000P</u>	<u>10</u>	<u>02-7001</u>	<u>6</u>
<u>C</u>	<u>3/8</u>	<u>5/8</u>	<u>15/32</u>	<u>02-7002</u>	<u>100</u>	<u>02-7002D</u>	<u>1</u>	<u>02-7002P</u>	<u>10</u>	<u>02-7003</u>	<u>6</u>
<u>D</u>	<u>3/8</u>	<u>13/16</u>	<u>3/8</u>	<u>02-1712</u>	<u>100</u>	<u>02-1712D</u>	<u>1</u>	<u>02-1712P</u>	<u>10</u>	<u>02-1713</u>	<u>6</u>
<u>E</u>	<u>3/8</u>	<u>7/8</u>	<u>1/8</u>	<u>02-1716</u>	<u>100</u>	<u>02-1716D</u>	<u>1</u>	<u>02-1716P</u>	<u>10</u>	<u>02-1717</u>	<u>6</u>
<u>F</u>	<u>3/8</u>	<u>7/8</u>	<u>3/8</u>	<u>02-1644</u>	<u>100</u>	<u>02-1644D</u>	<u>1</u>	<u>02-1644P</u>	<u>10</u>	<u>02-1645</u>	<u>6</u>
<u>G</u>	<u>13/16</u>	<u>5/8</u>	<u>3/8</u>	<u>02-1704</u>	<u>100</u>	<u>02-1704D</u>	<u>1</u>	<u>02-1704P</u>	<u>10</u>	<u>02-1705</u>	<u>6</u>
<u>H</u>	<u>13/16</u>	<u>11/16</u>	<u>3/16</u>	<u>02-1706</u>	<u>100</u>	<u>02-1706D</u>	<u>1</u>	<u>02-1706P</u>	<u>10</u>	<u>02-1707</u>	<u>6</u>
<u>I</u>	<u>13/16</u>	<u>3/4</u>	<u>11/32</u>	<u>02-1710</u>	<u>100</u>	<u>02-1710D</u>	<u>1</u>	<u>02-1710P</u>	<u>10</u>	<u>02-1711</u>	<u>6</u>
<u>J</u>	<u>7/16</u>	<u>7/8</u>	<u>1/4</u>	<u>02-1732</u>	<u>100</u>	<u>02-1732D</u>	<u>1</u>	<u>02-1732P</u>	<u>10</u>	<u>02-1733</u>	<u>6</u>
<u>K</u>	<u>15/32</u>	<u>3/4</u>	<u>3/8</u>	<u>02-7004</u>	<u>100</u>	<u>02-7004D</u>	<u>1</u>	<u>02-7004P</u>	<u>10</u>	<u>02-7005</u>	<u>6</u>
<u>L</u>	<u>1/2</u>	<u>25/32</u>	<u>1/16</u>	<u>02-1714</u>	<u>100</u>	<u>02-1714D</u>	<u>1</u>	<u>02-1714P</u>	<u>10</u>	<u>02-1715</u>	<u>6</u>
<u>M</u>	<u>1/2</u>	<u>29/32</u>	<u>11/32</u>	<u>02-1698</u>	<u>100</u>			<u>02-1698P</u>	<u>10</u>	<u>02-1699</u>	<u>6</u>
<u>N</u>	<u>9/16</u>	<u>7/8</u>	<u>1/4</u>	<u>02-1740</u>	<u>100</u>	<u>02-1740D</u>	<u>1</u>	<u>02-1740P</u>	<u>10</u>	<u>02-1741</u>	<u>6</u>
<u>O</u>	<u>5/8</u>	<u>31/32</u>	<u>1/4</u>	<u>02-1776</u>	<u>100</u>			<u>02-1776P</u>	<u>10</u>	<u>02-1777</u>	<u>6</u>
<u>P</u>	<u>5/8</u>	<u>1"</u>	<u>1/8</u>	<u>02-1682</u>	<u>100</u>	<u>02-1682D</u>	<u>1</u>	<u>02-1682P</u>	<u>10</u>	<u>02-1683</u>	<u>6</u>
<u>Q</u>	<u>11/16</u>	<u>31/32</u>	<u>3/8</u>	<u>02-1768</u>	<u>100</u>			<u>02-1768P</u>	<u>10</u>		
<u>R</u>	<u>13/16</u>	<u>1"</u>	<u>7/32</u>	<u>02-1778</u>	<u>100</u>	<u>02-1778D</u>	<u>1</u>	<u>02-1778P</u>	<u>10</u>	<u>02-1779</u>	<u>6</u>
<u>S</u>	<u>13/16</u>	<u>1"</u>	<u>1/4</u>	<u>02-1788</u>	<u>100</u>			<u>02-1788P</u>	<u>10</u>	<u>02-1789</u>	<u>6</u>
						<b>02-1710C</b>	<b>=</b>	<b>Bag of 100</b>			

## GRAPHITE CONE PACKING

<u>1</u>	<u>11/32</u>	<u>21/32</u>	<u>9/32</u>	<u>02-2350</u>	<u>100</u>	<u>02-2350D</u>	<u>1</u>	<u>02-2350P</u>	<u>10</u>	<u>02-2351</u>	<u>6</u>
<u>2</u>	<u>13/32</u>	<u>11/16</u>	<u>9/32</u>	<u>02-2352</u>	<u>100</u>	<u>02-2352D</u>	<u>1</u>	<u>02-2352P</u>	<u>10</u>	<u>02-2353</u>	<u>6</u>
<u>3</u>	<u>13/32</u>	<u>3/4</u>	<u>9/32</u>	<u>02-2354</u>	<u>100</u>	<u>02-2354D</u>	<u>1</u>	<u>02-2354P</u>	<u>10</u>	<u>02-2355</u>	<u>6</u>
<u>4</u>	<u>13/32</u>	<u>7/8</u>	<u>3/8</u>	<u>02-2356</u>	<u>100</u>	<u>02-2356D</u>	<u>1</u>	<u>02-2356P</u>	<u>10</u>	<u>02-2357</u>	<u>6</u>
<u>5</u>	<u>1/2</u>	<u>15/16</u>	<u>3/8</u>	<u>02-2358</u>	<u>100</u>	<u>02-2358D</u>	<u>1</u>	<u>02-2358P</u>	<u>10</u>	<u>02-2359</u>	<u>6</u>
Assorted 3 Sizes 6 Total Pieces										<u>02-2361</u>	<u>6</u>

## DOME PACKING













<u>1</u>	<u>3/8</u>	<u>3/4</u>	<u>1/8</u>	<u>02-2362</u>	<u>100</u>	<u>02-2362D</u>	<u>1</u>	<u>02-2362P</u>	<u>10</u>	<u>02-2363</u>	<u>6</u>
<u>2</u>	<u>3/8</u>	<u>3/4</u>	<u>5/16</u>	<u>02-2364</u>	<u>100</u>	<u>02-2364D</u>	<u>1</u>	<u>02-2364P</u>	<u>10</u>	<u>02-2365</u>	<u>6</u>
<u>3</u>	<u>7/16</u>	<u>1"</u>	<u>11/32</u>	<u>02-2366</u>	<u>100</u>	<u>02-2366D</u>	<u>1</u>	<u>02-2366P</u>	<u>10</u>	<u>02-2367</u>	<u>6</u>
<u>4</u>	<u>3/8</u>	<u>7/8</u>	<u>1/4</u>	<u>02-2368</u>	<u>100</u>	<u>02-2368D</u>	<u>1</u>	<u>02-2368P</u>	<u>10</u>	<u>02-2369</u>	<u>6</u>
<u>5</u>	<u>3/8</u>	<u>11/16</u>	<u>1/4</u>	<u>02-2370</u>	<u>100</u>	<u>02-2370D</u>	<u>1</u>	<u>02-2370P</u>	<u>10</u>	<u>02-2371</u>	<u>6</u>
<u>6</u>	<u>3/8</u>	<u>3/4</u>	<u>1/4</u>	<u>02-2372</u>	<u>100</u>	<u>02-2372D</u>	<u>1</u>	<u>02-2372P</u>	<u>10</u>	<u>02-2373</u>	<u>6</u>
<u>7</u>	<u>3/8</u>	<u>15/16</u>	<u>5/16</u>	<u>02-2374</u>	<u>100</u>	<u>02-2374D</u>	<u>1</u>	<u>02-2374</u>	<u>10</u>	<u>02-2375</u>	<u>6</u>
<u>8</u>	<u>3/8</u>	<u>7/8</u>	<u>5/16</u>	<u>02-2376</u>	<u>100</u>	<u>02-2376D</u>	<u>1</u>	<u>02-2376P</u>	<u>10</u>	<u>02-2377</u>	<u>6</u>
<u>9</u>	<u>13/32</u>	<u>3/4</u>	<u>5/16</u>	<u>02-2378</u>	<u>100</u>	<u>02-2378D</u>	<u>1</u>	<u>02-2378P</u>	<u>10</u>	<u>02-2379</u>	<u>6</u>
<u>10</u>	<u>13/32</u>	<u>15/16</u>	<u>13/32</u>	<u>02-2380</u>	<u>100</u>	<u>02-2380D</u>	<u>1</u>	<u>02-2380P</u>	<u>10</u>	<u>02-2381</u>	<u>6</u>
<u>11</u>	<u>11/32</u>	<u>21/32</u>	<u>9/32</u>	<u>02-2382</u>	<u>100</u>	<u>02-2382D</u>	<u>1</u>	<u>02-2382P</u>	<u>10</u>	<u>02-2383</u>	<u>6</u>

## TOP BIBB WASHERS

<u>1</u>	<u>3/8</u>	<u>7/8</u>		<u>02-3000</u>	<u>100</u>			<u>02-3000P</u>	<u>10</u>		
<u>2</u>	<u>3/8</u>	<u>15/16</u>		<u>02-3002</u>	<u>100</u>			<u>02-3002P</u>	<u>10</u>		
<u>3</u>	<u>3/8</u>	<u>1-1/16</u>		<u>02-3004</u>	<u>100</u>			<u>02-3004P</u>	<u>10</u>		
<u>4</u>	<u>3/8</u>	<u>1-1/8</u>		<u>02-3006</u>	<u>100</u>						
<u>5</u>	<u>3/8</u>	<u>1-1/4</u>		<u>02-3008</u>	<u>100</u>			<u>02-3008P</u>	<u>10</u>		
<u>6</u>	<u>3/8</u>	<u>1-3/8</u>		<u>02-3010</u>	<u>100</u>						
<u>7</u>	<u>3/8</u>	<u>1-1/2</u>		<u>02-3012</u>	<u>100</u>						
Assorted 50 Total Pieces					<u>02-3014</u>	<u>50</u>					















# SQUARE CUT PACKING

DANCO #	KIRK #	P&M #	DANCO #	KIRK #	P&M #	DANCO #	KIRK #	P&M #
		<b>12801</b>			<b>12605</b>		<b>P-99-23</b>	
I.D. 5/16 0.300	O.D. 9/16 0.570	THICK 5/16 0.320	I.D. 3/8 0.380	O.D. 17/32 0.530	THICK 1/4 0.240	I.D. 3/8 0.375	O.D. 9/16 0.560	THICK 1/4 0.250
								
Moen (Teflon)			Eljer, Crane, Sayco, Gopher (Teflon)			(Rubber)		
LASCO# <b>02-1700</b> <b>1</b>			LASCO# <b>02-1702</b> <b>2</b>			LASCO# <b>02-1786</b> <b>3</b>		
		<b>12641</b>			<b>12705</b>			
I.D. 3/8 0.380	O.D. 9/16 0.560	THICK 3/16 0.180	I.D. 3/8 0.380	O.D. 21/32 0.650	THICK 3/8 0.370	I.D. 3/8 0.380	O.D. 5/8 0.640	THICK 7/32 0.230
								
Central Brass Stem Packing (Graphite)			Sayco (Teflon)			(Graphite)		
LASCO# <b>02-1648</b> <b>4</b>			LASCO# <b>02-1708</b> <b>5</b>			LASCO# <b>06-9980</b> <b>5A</b>		
		<b>P-99-20</b>						<b>P-99-8</b>
I.D. 3/8 0.380	O.D. 3/4 0.740	THICK 3/16 0.190	I.D. 3/8 0.390	O.D. 3/4 0.750	THICK 5/16 0.310	I.D. 3/8 0.380	O.D. 5/8 0.630	THICK 3/16 0.185
								
(Graphite)			(Teflon)			(Molded Rubber)		
LASCO# <b>02-1772</b> <b>6</b>			LASCO# <b>02-1720</b> <b>7</b>			LASCO# <b>02-1680</b> <b>8</b>		
		<b>12606</b>			<b>12507, 12510</b>			<b>12802</b>
I.D. 31/32 0.400	O.D. 9/16 0.550	THICK 3/8 0.370	I.D. 13/32 0.400	O.D. 11/16 0.680	THICK 5/16 0.310	I.D. 7/16 0.435	O.D. 5/8 0.615	THICK 5/16 0.300
								
Briggs (Teflon)			Briggs, Central, Eljer (Teflon)			Speakman (Teflon)		
LASCO# <b>02-1718</b> <b>9</b>			LASCO# <b>02-1722</b> <b>10</b>			LASCO# <b>02-1724</b> <b>11</b>		

09/15/00











# SQUARE CUT PACKING

DANCO #	KIRK #	P&M #	DANCO #	KIRK #	P&M #	DANCO #	KIRK #	P&M #
	<b>P-99-15</b>				<b>12508, 12509</b>			
I.D. 7/16 0.440	O.D. 21/32 0.660	THICK 1/4 0.250	I.D. 7/16 0.430	O.D. 21/32 0.660	THICK 5/16 0.300	I.D. 7/16 0.430	O.D. 11/16 0.680	THICK 1/4 0.250
								
Duck Type Packing (Rubber)			American Standard, Kohler (Teflon)			Price Pfister PP950-310 (Rubber)		
LASCO# <b>02-1694</b>			LASCO# <b>02-1726</b>			LASCO# <b>02-7010</b>		
<b>12</b>			<b>13</b>			<b>14</b>		
		<b>12746</b>			<b>12511, 12513</b>			
I.D. 7/16 0.440	O.D. 11/16 0.690	THICK 5/16 0.315	I.D. 7/16 0.430	O.D. 3/4 0.745	THICK 5/16 0.315	I.D. 7/16 0.440	O.D. 25/32 0.795	THICK 1/4 0.250
								
Logan (Teflon)			Briggs, Eljer (Graphite)			(Teflon)		
LASCO# <b>02-1728</b>			LASCO# <b>02-1730</b>			LASCO# <b>02-1734</b>		
<b>15</b>			<b>16</b>			<b>19</b>		
					<b>P-85</b>			<b>12512</b>
I.D. 7/16 0.430	O.D. 7/8 0.860	THICK 5/16 0.320	I.D. 15/32 0.460	O.D. 5/8 0.620	THICK 5/16 0.315	I.D. 15/32 0.465	O.D. 7/8 0.870	THICK 5/16 0.320
								
(Teflon)			Price Pfister (Graphite)			Repcal (Graphite)		
LASCO# <b>02-1736</b>			LASCO# <b>02-1640</b>			LASCO# <b>02-1738</b>		
<b>20</b>			<b>21</b>			<b>22</b>		
		<b>12711</b>						<b>12515</b>
I.D. 1/2 0.500	O.D. 13/16 0.810	THICK 5/16 0.305	I.D. 1/2 0.515	O.D. 29/32 0.905	THICK 15/32 0.470	I.D. 19/32 0.590	O.D. 25/32 0.780	THICK 11/32 0.350
								
Kohler (Teflon)			(Teflon)			American Standard (Teflon)		
LASCO# <b>02-1742</b>			LASCO# <b>02-1746</b>			LASCO# <b>02-1744</b>		
<b>23</b>			<b>24</b>			<b>25</b>		

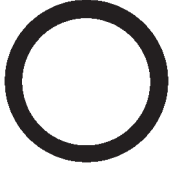

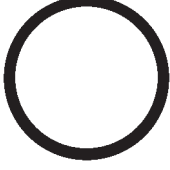
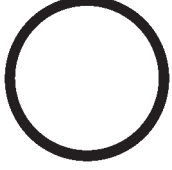











# SQUARE CUT PACKING

DANCO #	KIRK #	P&M #	DANCO #	KIRK #	P&M #	DANCO #	KIRK #	P&M #
I.D. 19/32 0.580	O.D. 29/32 0.900	THICK 1/2 0.500	I.D. 19/32 0.600	O.D. 7/8 0.890	THICK 5/32 0.150	I.D. 5/8 0.620	O.D. 3/4 0.750	THICK 5/16 0.350
								
American Standard (Rubber)			Price Pfister PP951-530 (Rubber)			Duck Type Packing (Rubber)		
LASCO# <b>02-7012</b>			LASCO# <b>02-7190</b>			LASCO# <b>02-1690</b>		
<b>26</b>			<b>26A</b>			<b>27</b>		
DANCO #	KIRK #	P&M #	DANCO #	KIRK #	P&M #	DANCO #	KIRK #	P&M #
	<b>P-99-14</b>			<b>P-99-10</b>			<b>P-99-19</b>	
I.D. 5/8 0.640	O.D. 27/32 0.850	THICK 7/32 0.220	I.D. 5/8 0.620	O.D. 7/8 0.880	THICK 1/4 0.260	I.D. 11/16 0.675	O.D. 7/8 0.860	THICK 5/16 0.315
								
American Standard AS473-07 (Rubber)			(Graphite)			(Graphite)		
LASCO# <b>02-1692</b>			LASCO# <b>02-1684</b>			LASCO# <b>02-1770</b>		
<b>28</b>			<b>29</b>			<b>30</b>		
DANCO #	KIRK #	P&M #	DANCO #	KIRK #	P&M #	DANCO #	KIRK #	P&M #
		<b>17642</b>		<b>P-98-7</b>			<b>P-99-16</b>	
I.D. 11/16 0.685	O.D. 7/8 0.875	THICK 1/16 0.060	I.D. 11/16 0.700	O.D. 7/8 0.860	THICK 3/16 0.200	I.D. 3/4 0.750	O.D. 7/8 0.870	THICK 5/16 0.310
								
Kohler 33031 Price Pfister (Cork)			(Graphite)			(Teflon)		
LASCO# <b>02-7006</b>			LASCO# <b>02-1652</b>			LASCO# <b>02-1696</b>		
<b>31</b>			<b>32</b>			<b>33</b>		
DANCO #	KIRK #	P&M #	DANCO #	KIRK #	P&M #	DANCO #	KIRK #	P&M #
				<b>P-99-11</b>			<b>P-99-12</b>	
I.D. 3/4 0.760	O.D. 7/8 0.870	THICK 5/16 0.300	I.D. 3/4 0.740	O.D. 15/16 0.940	THICK 3/8 0.390	I.D. 3/4 0.740	O.D. 1" 0.980	THICK 1/4 0.250
								
Chicago Spout Washer (Rubber)			(Graphite)			(Graphite)		
LASCO# <b>02-1782</b>			LASCO# <b>02-1686</b>			LASCO# <b>02-1688</b>		
<b>34</b>			<b>35</b>			<b>36</b>		

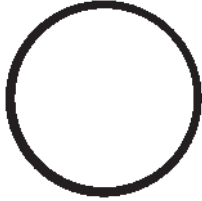













# SQUARE CUT PACKING

DANCO #	KIRK #	P&M #	DANCO #	KIRK #	P&M #	DANCO #	KIRK #	P&M #
	<b>P-99-21</b>				<b>17777</b>		<b>W-53B</b>	<b>17636</b>
I.D. 25/32 0.795	O.D. 1-1/16 1.070	THICK 7/32 0.230	I.D. 13/16 0.820	O.D. 1-1/16 1.070	THICK 1/16 0.060	I.D. 13/16 0.830	O.D. 1-1/8 1.120	THICK 1/8 0.120
								
(Graphite)			Chicago 1-43 (Cork)			Crane (Cork)		
LASCO# <b>02-1774</b>			LASCO# <b>02-7008</b>			LASCO# <b>02-1760</b>		
<b>37</b>			<b>38</b>			<b>39</b>		
	<b>P-98-15</b>			<b>P-98-6</b>				
I.D. 21/32 0.650	O.D. 27/32 0.849	THICK 13/32 0.400	I.D. 7/8 0.890	O.D. 1-5/32 1.150	THICK 3/16 0.180	I.D. 1" 1.000	O.D. 1-1/4 1.250	THICK 1/8 0.125
								
Split Packing (Graphite)			(Graphite)			American Standard (Graphite)		
LASCO# <b>02-1666</b>			LASCO# <b>02-1650</b>			LASCO# <b>02-1790</b>		
<b>40</b>			<b>41</b>			<b>42</b>		
I.D. 15/16 0.940	O.D. 1-1/32 1.031	THICK 1/8 0.125	I.D.	O.D.	THICK	I.D.	O.D.	THICK
								
(Rubber)								
LASCO# <b>02-1656</b>			LASCO#			LASCO#		
<b>43</b>								
I.D.	O.D.	THICK	I.D.	O.D.	THICK	I.D.	O.D.	THICK
								
LASCO#			LASCO#			LASCO#		













# CLOTH-INSERTED SQUARE CUT PACKING

DANCO #	KIRK #	P&M #	DANCO #	KIRK #	P&M #	DANCO #	KIRK #	P&M #
		<b>12505, 12607</b>	<b>36623</b>		<b>12604</b>	<b>36611</b>		<b>12609</b>
I.D. 5/16 0.310	O.D. 5/8 0.625	THICK 7/32 0.220	I.D. 3/8 0.360	O.D. 9/16 0.560	THICK 1/4 0.270	I.D. 3/8 0.390	O.D. 5/8 0.630	THICK 15/32 0.470
								
Haws Stem Packing (Cloth-Inserted Rubber) LASCO# <b>02-1636</b> <b>A</b>			Crane (Cloth-Inserted Rubber) LASCO# <b>02-7000</b> <b>B</b>			Halsey, Taylor (Cloth-Inserted Rubber) LASCO# <b>02-7002</b> <b>C</b>		
		<b>P-99-5</b>						
I.D. 3/8 0.385	O.D. 13/16 0.800	THICK 3/8 0.360	I.D. 3/8 0.385	O.D. 7/8 0.860	THICK 1/8 0.110	I.D. 3/8 0.350	O.D. 7/8 0.870	THICK 3/8 0.370
								
(Cloth-Inserted Rubber) LASCO# <b>02-1712</b> <b>D</b>			#8 Medium Elk Washer (Cloth-Inserted Rubber) LASCO# <b>02-1716</b> <b>E</b>			Repcal Stem Packing (Cloth-Inserted Rubber) LASCO# <b>02-1644</b> <b>F</b>		
		<b>P-99-3</b>			<b>12614</b>			<b>12618</b>
I.D. 13/32 0.413	O.D. 5/8 0.620	THICK 3/8 0.370	I.D. 13/32 0.420	O.D. 11/16 0.680	THICK 1/4 0.230	I.D. 13/32 0.405	O.D. 3/4 0.745	THICK 11/32 0.350
								
Briggs, Central, Eljer (Cloth-Inserted Rubber) LASCO# <b>02-1704</b> <b>G</b>			Repcal (Cloth-Inserted Rubber) LASCO# <b>02-1706</b> <b>H</b>			Price Pfister (Cloth-Inserted Rubber) LASCO# <b>02-1710</b> <b>I</b>		
		<b>P-99-7</b>			<b>12621</b>			<b>12616</b>
I.D. 7/16 0.440	O.D. 7/8 0.880	THICK 1/4 0.290	I.D. 15/32 0.475	O.D. 3/4 0.750	THICK 3/8 0.360	I.D. 1/2 0.500	O.D. 25/32 0.810	THICK 1/16 0.060
						#19 Small Elk Washer" data-bbox="710 800 805 875"/>		
Repcal, Universal (Cloth-Inserted Rubber) LASCO# <b>02-1732</b> <b>J</b>			Kohler (Cloth-Inserted Rubber) LASCO# <b>02-7004</b> <b>K</b>			#19 Small Elk Washer (Cloth-Inserted Rubber) LASCO# <b>02-1714</b> <b>L</b>		



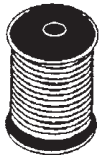
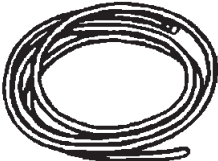











# CLOTH-INSERTED SQUARE CUT PACKING

DANCO #	KIRK #	P&M #	DANCO #	KIRK #	P&M #	DANCO #	KIRK #	P&M #
	<b>P-99-17</b>			<b>P-84</b>			<b>P-99-22</b>	
I.D. 1/2 0.500	O.D. 29/32 0.920	THICK 11/32 0.340	I.D. 9/16 0.550	O.D. 7/8 0.870	THICK 1/4 0.240	I.D. 5/8 0.650	O.D. 31/32 0.960	THICK 1/4 0.290
								
(Cloth-Inserted Rubber)			(Cloth-Inserted Rubber)			(Cloth-Inserted Rubber)		
LASCO# <b>02-1698</b>			LASCO# <b>02-1740</b>			LASCO# <b>02-1776</b>		
<b>M</b>			<b>N</b>			<b>O</b>		
	<b>P-99-9</b>			<b>P-99-18</b>				
I.D. 5/8 0.645	O.D. 1" 0.980	THICK 1/8 0.130	I.D. 11/16 0.690	O.D. 31/32 0.950	THICK 3/8 0.360	I.D. 13/16 0.810	O.D. 1" 0.985	THICK 7/32 0.230
								
(Cloth-Inserted Rubber)			(Cloth-Inserted Rubber)			Price Pfister PP951-530 (Cloth-Inserted Rubber)		
LASCO# <b>02-1682</b>			LASCO# <b>02-1768</b>			LASCO# <b>02-1778</b>		
<b>P</b>			<b>Q</b>			<b>R</b>		
	<b>P-99-24</b>							
I.D. 13/16 0.820	O.D. 1" 1.000	THICK 1/4 0.290	I.D.	O.D.	THICK	I.D.	O.D.	THICK
								
(Cloth-Inserted Rubber)								
LASCO# <b>02-1788</b>			LASCO#			LASCO#		
<b>S</b>								
<b>1/4 # Spool Graphite Packing</b>			<b>Teflon String Packing</b>			<b>Graphite String Packing</b>		
02-2530	1/8" x 144"	1 Spool	02-2500	3/32 x 24"	100 Bulk	02-2516	1/8 x 24"	100 Bulk
02-2532	1/4" x 96"	1 Spool	02-2500P	3/32 x 24"	12 Bag	02-2516P	1/8 x 24"	12 Bag
			02-2501	3/32 x 24"	6 Card	02-2517	1/8 x 24"	6 Card
								

02/27/04

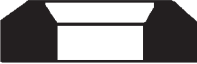













# CONE & DOME PACKING

DANCO # <b>P-59</b> I.D. 11/32 O.D. 21/32 THICK 9/32  (Graphite) LASCO# <b>02-2350</b> <b>1</b>	DANCO # <b>P-59A</b> I.D. 13/32 O.D. 11/16 THICK 9/32  (Graphite) LASCO# <b>02-2352</b> <b>2</b>	DANCO # <b>P-60</b> I.D. 13/32 O.D. 3/4 THICK 9/32  (Graphite) LASCO# <b>02-2354</b> <b>3</b>
DANCO # <b>P-61</b> I.D. 13/32 O.D. 7/8 THICK 3/8  (Graphite) LASCO# <b>02-2356</b> <b>4</b>	DANCO # <b>P-62</b> I.D. 1/2 O.D. 15/16 THICK 3/8  (Graphite) LASCO# <b>02-2358</b> <b>5</b>	DANCO # KIRK # <b>P-98-5</b> P&M # <b>12303</b>  LASCO#
DANCO # <b>P-98-11</b> I.D. 3/8 O.D. 3/4 THICK 1/8  American Standard, Colony LASCO# <b>02-2362</b> <b>1</b>	DANCO # <b>P-98-2</b> I.D. 3/8 O.D. 3/4 THICK 5/16  American Standard, Schaible LASCO# <b>02-2364</b> <b>2</b>	DANCO # <b>P-98-20</b> I.D. 7/16 O.D. 1" THICK 11/32  American Standard, Schaible LASCO# <b>02-2366</b> <b>3</b>
DANCO # <b>P-98-11</b> I.D. 3/8 O.D. 7/8 THICK 1/4  Central LASCO# <b>02-2368</b> <b>4</b>	DANCO # <b>P-98-2</b> I.D. 3/8 O.D. 11/16 THICK 1/4  Chicago LASCO# <b>02-2370</b> <b>5</b>	DANCO # <b>P-98-20</b> I.D. 3/8 O.D. 3/4 THICK 1/4  Kohler LASCO# <b>02-2372</b> <b>6</b>



# DOME PACKING & TOP BIBB WASHERS

DANCO #	KIRK #	P&M #	DANCO #	KIRK #	P&M #	DANCO #	KIRK #	P&M #
	<b>P-98-17</b>	<b>12332</b>			<b>12302</b>		<b>P-98-3</b>	<b>12380</b>
I.D. 3/8	O.D. 15/16	THICK 5/16	I.D. 3/8	O.D. 7/8	THICK 5/16	I.D. 13/32	O.D. 3/4	THICK 5/16
								
Kohler			Schaible, Tracy			Sterling		
LASCO# <b>02-2374</b>			LASCO# <b>02-2376</b>			LASCO# <b>02-2378</b>		
7			8			9		
	<b>P-98-4</b>	<b>12370</b>		<b>P-98-1</b>	<b>12378</b>		<b>W-349</b>	
I.D. 13/32	O.D. 15/16	THICK 13/32	I.D. 11/32	O.D. 21/32	THICK 9/32	I.D. 3/8	O.D. 7/8	
								
Speakman			Sterling			Top Bibb Washer, Cloth Inserted Rubber		
LASCO# <b>02-2380</b>			LASCO# <b>02-2382</b>			LASCO# <b>02-3000</b>		
10			11			1		
	<b>W-350</b>			<b>W-350L</b>			<b>W-351</b>	
I.D. 3/8	O.D. 15/16		I.D. 3/8	O.D. 1-1/16		I.D. 3/8	O.D. 1-1/8	
								
Top Bibb Washer, Cloth Inserted Rubber			Top Bibb Washer, Cloth Inserted Rubber			Top Bibb Washer, Cloth Inserted Rubber		
LASCO# <b>02-3002</b>			LASCO# <b>02-3004</b>			LASCO# <b>02-3006</b>		
2			3			4		
	<b>W352</b>			<b>W-353</b>			<b>W-354</b>	
I.D. 3/8	O.D. 1-1/4		I.D. 3/8	O.D. 1-3/8		I.D. 3/8	O.D. 1-1/2	
								
Top Bibb Washer, Cloth Inserted Rubber			Top Bibb Washer, Cloth Inserted Rubber			Top Bibb Washer, Cloth Inserted Rubber		
LASCO# <b>02-3008</b>			LASCO# <b>02-3010</b>			LASCO# <b>02-3012</b>		
5			6			7		



# NYLON and FIBER WASHERS

## Stem Cap Gaskets

POP	I.D.	O.D.	THICK	MAT.	BULK	CTN.	POLY BAG 12/BAG	CTN.	UPC BAG 1/BAG	CTN.	CARD 2/CARD	CTN.
1	1/4	21/32	1/32	A	02-1894	100	02-1894D	1	02-1894P	1	02-1895	6
2	3/8	1/2	3/32	F	02-7508	100	02-7508D	1		1	02-7509	6
3	3/8	23/32	1/8	F	02-1864	100	02-1864D	1	02-1864P	1	02-1865	6
4	3/8	3/4	1/32	N	02-1288	100	02-1288D	1	02-1288P	1	02-1289	6
5	3/8	3/4	1/8	F	02-1814	100	02-1814D	1	02-1814P	1	02-1815	6
6	11/32	29/32	1/16	F	02-1874	100	02-1874D	1	02-1874P	1		
7	3/8	1-1/32	1/32	F	02-1880	100			02-1880P	1		
8	13/32	29/32	1/16	F	02-1876	100			02-1876P	1		
9	13/32	29/32	1/16	F	02-1670	100			02-1670P	1		
10	13/32	1"	1/16	F	02-1848	100	02-1848D	1	02-1848P	1	02-1849	6
11	7/16	21/32	1/32	F	02-1800	100	02-1800D	1	02-1800P	1	02-1801	6
12	7/16	9/16	1/16	A	02-1892	100			02-1892P	1		
13	7/16	13/16	1/16	F	02-1674	100			02-1674P	1		
14	7/16	7/8	1/16	F	02-1676	100			02-1676P	1		
15	7/16	29/32	1/16	F	02-1846	100	02-1846D	1	02-1846P	1	02-1847	6
16	7/16	31/32	3/32	F	02-1668	100			02-1668P	1		
17	7/16	31/32	3/32	F	02-1878	100			02-1878P	1		
18	7/16	1-1/16	1/16	F	02-1896	100	02-1896D	1	02-1896P	1	02-1897	6
19	7/16	1-1/8	1/16	F	02-1850	100	02-1850D	1	02-1850P	1	02-1851	6
20	1/2	21/32	1/32	F	02-1802	100	02-1802D	1	02-1802P	1	02-1803	6
21	1/2	3/4	1/32	F	02-1872	100	02-1872D	1	02-1872P	1	02-1873	6
22	1/2	13/16	1/32	F	02-1868	100	02-1868D	1	02-1868P	1	02-1869	6
23	1/2	13/16	1/16	F	02-1816	100	02-1816D	1	02-1816P	1	02-1817	6
24	9/16	11/16	1/32	N	02-1862	100	02-1862D	1	02-1862P	1	02-1863	6
25	9/16	29/32	1/8	F	02-1860	100			02-1860P	1	02-1861	6
26	19/32	15/16	1/16	F	02-1818	100	02-1818D	1	02-1818P	1	02-1819	6
27	19/32	15/16	1/8	F	02-7504	100	02-7504D	1	02-7504P	1	02-7505	6
28	5/8	23/32	1/32	N	02-1838	100	02-1838D	1	02-1838P	1	02-1839	6
28							<b>02-1838C</b>	=	<b>Bag of 100</b>			
29	5/8	13/16	1/32	F	02-1870	100	02-1870D	1	02-1870P	1	02-1871	6
30	5/8	7/8	1/8	N	02-1836	100	02-1836D	1	02-1836P	1	02-1837	6
31	5/8	15/16	1/16	N	02-1808	100	02-1808D	1	02-1808P	1	02-1809	6
31							<b>02-1808C</b>	=	<b>Bag of 100</b>			
32	23/32	1-3/16	1/32	C	02-1832	100	02-1832D	1		1		
33	5/8	1"	1/16	F	02-1834	100	02-1834D	1	02-1834P	1	02-1835	6
34	3/4	13/16	1/16	F	02-1956	100	02-1956D	1	02-1956P	1	02-1957	6
35	3/4	7/8	1/16	N	02-1842	100	02-1842D	1	02-1842P	1	02-1843	6
35							<b>02-1842C</b>	=	<b>Bag of 100</b>			

Note: Material

- A = Asbestos
- C = Copper
- F = Fiber
- N = Nylon



# NYLON and FIBER WASHERS

## Stem Cap Gaskets

POP	I.D.	O.D.	THICK	MAT.	BULK	CTN.	POLY BAG 12/BAG	CTN.	UPC BAG 1/BAG	CTN.	CARD 2/CARD	CTN.
36	3/4	15/16	1/16	N	02-1804	100	02-1804D	1	02-1804P	1	02-1805	6
37	3/4	1"	1/16	F	02-1840	100	02-1840D	1	02-1840P	1	02-1841	6
38	13/16	15/16	1/16	F	02-1844	100	02-1844D	1	02-1844P	1	02-1845	6
38							<b>02-1844C</b>	=	<b>Bag of 100</b>			
39	13/16	1"	1/16	F	02-1812	100	02-1812D	1	02-1812P	1	02-1813	6
40	7/8	15/16	1/16	F	02-7506	100	02-7506D	1				
41	7/8	1-1/32	1/16	F	02-1806	100	02-1806D	1	02-1806P	1	02-1807	6
42	7/8	1-3/32	1/16?	F	02-1826	100	02-1826D	1	02-1826P	1	02-1827	6
43	7/8	1-3/16	1/16	N	02-1822	100	02-1822D	1	02-1822P	1	02-1823	6
43							<b>02-1822C</b>	=	<b>Bag of 100</b>			
44	31/32	1-3/32	1/32	F	02-1810	100	02-1810D	1	02-1810P	1		
45	31/32	1-1/8	1/32	F	02-7602	100						
46	31/32	1-5/32	1/16	F	02-1866	100	02-1866D	1	02-1866P	1		
47	1"	1-9/64	1/16	N	02-1820	100	02-1820D	1	02-1820P	1	02-1821	6
48	1"	1-1/4	1/16	F	02-1824	100	02-1824D	1	02-1824P	1	02-1825	6
49	1"	1-13/16	1/32	N	02-7500	100	02-7500D	1	02-7500P	1	02-7501	6
50	1-1/16	1-1/4	1/8	F	02-1858	100	02-1858D	1	02-1858P	1	02-1859	6
51	1-1/16	1-1/2	1/32	N	02-7620	100						
52	1-1/8	1-3/8	1/32	F	02-1950	100			02-1950P	1		
54	1-3/16	1-1/2	1/16	F	02-1954	100			02-1954P	1		
55	1-1/4	1-7/16	1/16	F	02-1952	100			02-1952P	1		
56	1-1/4	1-1/2	1/32	F	02-1852	100	02-1852D	1	02-1852P	1	02-1853	6
57	1-5/16	1-9/16	1/16	F	02-1830	100	02-1830D	1	02-1830P	1	02-1831	6
58	1-3/8	1-5/8	1/32	F	02-7612	100						
59	1-3/8	2-1/4	1/32	F	02-7610	100			02-7610P	1		
60	1-7/16	1-11/16	1/16	F	02-1828	100	02-1828D	1	02-1828P	1	02-1829	6
61	1-7/16	1-3/4	1/8	F	02-2056	100			02-2056P	1	02-2057	6
62	1-1/2	1-13/16	1/32	F	15-9610	100	15-9610D	1				
63	1-11/16	1-15/16	1/32	F	02-1854	100	02-1854D	1	02-1854P	1	02-1855	6
64	1-3/4	1-7/8	1/16	N	02-1886	100			02-1886P	1		
65	1-3/4	2"	1/32	N	02-1884	100			02-1844P	1		
53	2-1/8	2-7/32	1/32	N	02-7600	100			02-7600P	1		
66	2-3/8	3-7/32	1/32	N	02-2070	100					02-2071	6
67	3-17/32	4-11/32	1/8	R	02-2066	100	02-2066D	1	02-2066P	1		
68	3-17/32	4-11/32	1/32	N	02-2068	100	02-2068D	1	02-2068P	1		
67/68											02-2067	6











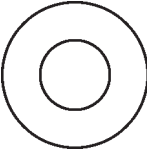

Note: Material

F = Fiber  
N = Nylon  
R = Rubber















# NYLON & FIBER WASHERS

DANCO #	KIRK #	P&M #	DANCO #	KIRK #	P&M #	DANCO #	KIRK #	P&M #
		<b>17621</b>			<b>17168</b>			<b>17630</b>
I.D. 1/4 0.250	O.D. 21/32 0.670	THICK 1/32 0.030	I.D. 3/8 0.390	O.D. 1/2 0.500	THICK 3/32 0.080	I.D. 3/8 0.370	O.D. 23/32 0.720	THICK 1/8 0.120
								
American Standard AS1326-07, Price Pfister PP950-370 (Asbestos)			Price Pfister 950-360 (Fiber)			Repcal (Fiber)		
LASCO# <b>02-1894</b> <b>1</b>			LASCO# <b>02-7508</b> <b>2</b>			LASCO# <b>02-1864</b> <b>3</b>		
		<b>11901</b>			<b>11901</b>			<b>11901</b>
I.D. 3/8 0.360	O.D. 3/4 0.750	THICK 1/32 0.030	I.D. 3/8 0.370	O.D. 3/4 0.750	THICK 1/8 0.130	I.D. 11/32 0.380	O.D. 29/32 0.870	THICK 1/16 0.060
								
American Standard Colony 72824-07 (Nylon)			(Fiber)			(Fiber)		
LASCO# <b>02-1288</b> <b>4</b>			LASCO# <b>02-1814</b> <b>5</b>			LASCO# <b>02-1874</b> <b>6</b>		
		<b>W-410XA</b>			<b>W-398-29E</b>			<b>P-98-18</b>
I.D. 3/8 0.375	O.D. 1-1/32 1.025	THICK 1/32 0.030	I.D. 13/32 0.410	O.D. 29/32 0.900	THICK 1/16 0.060	I.D. 13/32 0.415	O.D. 29/32 0.900	THICK 1/16 0.060
								
(Fiber)			(Fiber)			(Fiber)		
LASCO# <b>02-1880</b> <b>7</b>			LASCO# <b>02-1876</b> <b>8</b>			LASCO# <b>02-1670</b> <b>9</b>		
		<b>W-398-29-D</b>			<b>17632</b>			<b>17632</b>
I.D. 13/32 0.410	O.D. 1" 1.000	THICK 1/16 0.060	I.D. 7/16 0.440	O.D. 21/32 0.660	THICK 1/32 0.030	I.D. 7/16 0.450	O.D. 9/16 0.560	THICK 1/16 0.060
								
(Fiber)			(Fiber)			American Standard AS1325-07 (Asbestos)		
LASCO# <b>02-1848</b> <b>10</b>			LASCO# <b>02-1800</b> <b>11</b>			LASCO# <b>02-1892</b> <b>12</b>		





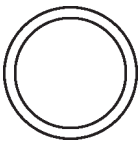



# NYLON & FIBER WASHERS

DANCO #	KIRK #	P&M #	DANCO #	KIRK #	P&M #	DANCO #	KIRK #	P&M #
	<b>P-98-21</b>			<b>P-98-22</b>			<b>W-398-29E</b>	
I.D. 7/16 0.440	O.D. 13/16 0.810	THICK 1/16 0.060	I.D. 7/16 0.440	O.D. 7/8 0.870	THICK 1/16 0.060	I.D. 7/16 0.425	O.D. 29/32 0.900	THICK 1/16 0.062
								
(Fiber)			(Fiber)			(Fiber)		
LASCO# <b>02-1674</b>			LASCO# <b>02-1676</b>			LASCO# <b>02-1846</b>		
<b>13</b>			<b>14</b>			<b>15</b>		
	<b>P-98-16</b>			<b>W-398-18C</b>			<b>P-98-23</b>	
I.D. 7/16 0.450	O.D. 31/32 0.960	THICK 3/32 0.085	I.D. 7/16 0.440	O.D. 31/32 0.980	THICK 3/32 0.090	I.D. 7/16 0.440	O.D. 1-1/16 1/16	THICK ??? ????
								
(Fiber)			(Fiber)			Repcal (Fiber)		
LASCO# <b>02-1668</b>			LASCO# <b>02-1878</b>			LASCO# <b>02-1896</b>		
<b>16</b>			<b>17</b>			<b>18</b>		
	<b>P-98-24</b>			<b>W-398-70D</b>			<b>W-398-3A</b>	
I.D. 7/16 0.450	O.D. 1-1/8 1.110	THICK 1/16 0.060	I.D. 1/2 0.510	O.D. 21/32 0.650	THICK 1/32 0.030	I.D. 1/2 0.500	O.D. 3/4 0.750	THICK 1/32 0.030
								
(Fiber)			(Fiber)			(Fiber)		
LASCO# <b>02-1850</b>			LASCO# <b>02-1802</b>			LASCO# <b>02-1872</b>		
<b>19</b>			<b>20</b>			<b>21</b>		
	<b>W-398-3A</b>			<b>W-398-70D</b>			<b>W-398-3A</b>	
I.D. 1/2 0.500	O.D. 13/16 0.800	THICK 1/32 0.030	I.D. 1/2 0.500	O.D. 13/16 0.800	THICK 1/16 0.060	I.D. 9/16 0.570	O.D. 11/16 0.680	THICK 1/32 0.030
								
(Fiber)			(Fiber)			Harcraft (Nylon)		
LASCO# <b>02-1868</b>			LASCO# <b>02-1816</b>			LASCO# <b>02-1862</b>		
<b>22</b>			<b>23</b>			<b>24</b>		

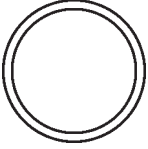

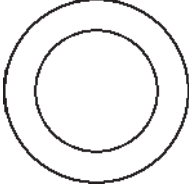
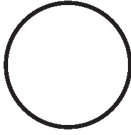

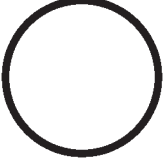
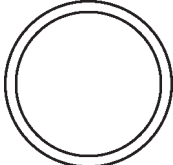
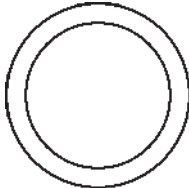



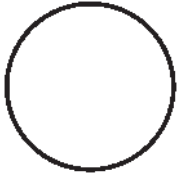

# NYLON & FIBER WASHERS

DANCO #	KIRK #	P&M #	DANCO #	KIRK #	P&M #	DANCO #	KIRK #	P&M #
I.D. <b>9/16</b> 0.555	O.D. <b>29/32</b> 0.900	THICK <b>1/8</b> 0.130	I.D. <b>19/32</b> 0.600	O.D. <b>15/16</b> 0.930	THICK <b>1/16</b> 0.060	I.D. <b>19/32</b> 0.590	O.D. <b>15/16</b> 0.930	THICK <b>1/8</b> 0.120
								
(Fiber)			(Fiber)			Price Pfister Wall Mount Union Washer (Fiber)		
<b>LASCO# 02-1860</b>			<b>LASCO# 02-1818</b>			<b>LASCO# 02-7504</b>		
<b>25</b>			<b>26</b>			<b>27</b>		
DANCO #	KIRK #	P&M #	DANCO #	KIRK #	P&M #	DANCO #	KIRK #	P&M #
	<b>W-398-67D</b>	<b>17634, 17668</b>			<b>17676</b>			<b>17670</b>
I.D. <b>5/8</b> 0.640	O.D. <b>23/32</b> 0.730	THICK <b>1/32</b> 0.030	I.D. <b>5/8</b> 0.630	O.D. <b>13/16</b> 0.810	THICK <b>1/32</b> 0.030	I.D. <b>5/8</b> 0.630	O.D. <b>7/8</b> 0.875	THICK <b>1/8</b> 0.120
								
Price Pfister PP950-190, Kohler, Milwaukee Universal Rundel (Nylon)			Sayco Diverter (Fiber)			Repcal Diverter (Nylon)		
<b>LASCO# 02-1838</b>			<b>LASCO# 02-1870</b>			<b>LASCO# 02-1836</b>		
<b>28</b>			<b>29</b>			<b>30</b>		
DANCO #	KIRK #	P&M #	DANCO #	KIRK #	P&M #	DANCO #	KIRK #	P&M #
		<b>20235</b>						
I.D. <b>5/8</b> 0.630	O.D. <b>15/16</b> 0.950	THICK <b>1/16</b> 0.070	I.D. <b>5/8</b> 0.635	O.D. <b>11/16</b> 0.680	THICK <b>1/32</b> 0.030	I.D. <b>5/8</b> 0.650	O.D. <b>1"</b> 1.020	THICK <b>1/16</b> 0.060
								
Price Pfister Diverter (Nylon)			Kohler (Copper)			(Fiber)		
<b>LASCO# 02-1808</b>			<b>LASCO# 02-1832</b>			<b>LASCO# 02-1834</b>		
<b>31</b>			<b>32</b>			<b>33</b>		
DANCO #	KIRK #	P&M #	DANCO #	KIRK #	P&M #	DANCO #	KIRK #	P&M #
	<b>W-398-64D</b>			<b>W-398-62B</b>	<b>17644</b>		<b>W-398-37G</b>	<b>17654</b>
I.D. <b>3/4</b> 0.770	O.D. <b>13/16</b> 0.840	THICK <b>1/16</b> 0.060	I.D. <b>3/4</b> 0.750	O.D. <b>7/8</b> 0.860	THICK <b>1/16</b> 0.060	I.D. <b>3/4</b> 0.750	O.D. <b>15/16</b> 0.950	THICK <b>1/16</b> 0.060
								
(Fiber)			Price Pfister & Most Others (Nylon)			Eljer, Repcal		
<b>LASCO# 02-1956</b>			<b>LASCO# 02-1842</b>			<b>LASCO# 02-1804</b>		
<b>34</b>			<b>35</b>			<b>36</b>		

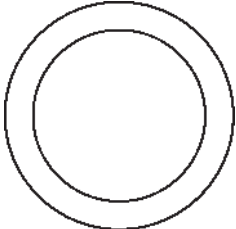
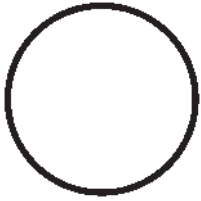

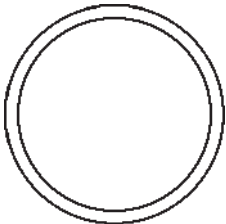

# NYLON & FIBER WASHERS

DANCO # <b>W-401A</b> <b>17660</b>	KIRK # <b>17660</b>	P&M #	DANCO # <b>W-398-16D</b> <b>17657</b>	KIRK # <b>17657</b>	P&M #	DANCO # <b>W-398-11E</b> <b>17663</b>	KIRK # <b>17663</b>	P&M #
I.D. <b>3/4</b> 0.750	O.D. <b>1"</b> 1.000	THICK <b>1/16</b> 0.060	I.D. <b>13/16</b> 0.820	O.D. <b>15/16</b> 0.950	THICK <b>1/16</b> 0.060	I.D. <b>13/16</b> 0.820	O.D. <b>1"</b> 0.980	THICK <b>1/16</b> 0.060
								
Eljer, Repcal, Sayco (Fiber)			Gerber, Kohler, Repcal, Sterling (Fiber)			Briggs, Scoville (Fiber)		
LASC0# <b>02-1840</b> <b>37</b>			LASC0# <b>02-1844</b> <b>38</b>			LASC0# <b>02-1812</b> <b>39</b>		
DANCO #	KIRK #	P&M #	DANCO #	KIRK #	P&M # <b>17661, 17712</b>	DANCO #	KIRK #	P&M #
DANCO #	KIRK #	P&M #				DANCO #	KIRK #	P&M #
I.D. <b>7/8</b> 0.850	O.D. <b>15/16</b> 0.900	THICK <b>1/16</b> 0.060	I.D. <b>7/8</b> 0.890	O.D. <b>1-1/32</b> 1.030	THICK <b>1/16</b> 0.060	I.D. <b>7/8</b> 0.890	O.D. <b>1-3/32</b> 1.080	THICK <b>1/16</b> 0.060
								
Price Pfister 949-030 (Fiber)			Crane, Gerber, Price Pfister (Fiber)			American Standard, Central, Repcal, Sterling (Fiber)		
LASC0# <b>02-7506</b> <b>40</b>			LASC0# <b>02-1806</b> <b>41</b>			LASC0# <b>02-1826</b> <b>42</b>		
DANCO #	KIRK #	P&M #	DANCO #	KIRK #	P&M #	DANCO #	KIRK #	P&M #
DANCO #	KIRK #	P&M #				DANCO #	KIRK #	P&M #
I.D. <b>7/8</b> 0.890	O.D. <b>1-3/16</b> 1.180	THICK <b>1/16</b> 0.060	I.D. <b>31/32</b> 0.950	O.D. <b>1-1/32</b> 1.020	THICK <b>1/32</b> 0.030	I.D. <b>31/32</b> 0.930	O.D. <b>1-1/8</b> 1.130	THICK <b>1/32</b> 0.030
								
Arrowhead, Price Pfister, Sayco, Tractline (Nylon)			Briggs, Eljer, Kohler (Fiber)			Kohler KO-34631 (Fiber)		
LASC0# <b>02-1822</b> <b>43</b>			LASC0# <b>02-1810</b> <b>44</b>			LASC0# <b>02-7602</b> <b>45</b>		
DANCO #	KIRK #	P&M #	DANCO #	KIRK #	P&M #	DANCO #	KIRK #	P&M #
DANCO #	KIRK #	P&M #				DANCO #	KIRK #	P&M #
I.D. <b>31/32</b> 0.970	O.D. <b>1-5/32</b> 1.140	THICK <b>1/16</b> 0.060	I.D. <b>1"</b> 1.000	O.D. <b>1-9/64</b> 1.130	THICK <b>1/16</b> 0.060	I.D. <b>1"</b> 1.000	O.D. <b>1-1/4</b> 1.240	THICK <b>1/16</b> 0.060
								
American Standard, Kohler (Fiber)			Price Pfister Diverter (Nylon)			Arrowhead, Price Pfister Diverter PP950-050, Repcal (Fiber)		
LASC0# <b>02-1866</b> <b>46</b>			LASC0# <b>02-1820</b> <b>47</b>			LASC0# <b>02-1824</b> <b>48</b>		

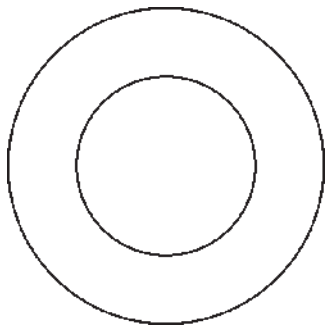
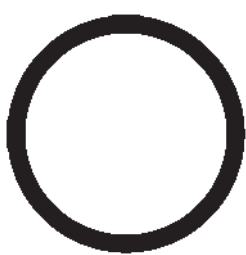
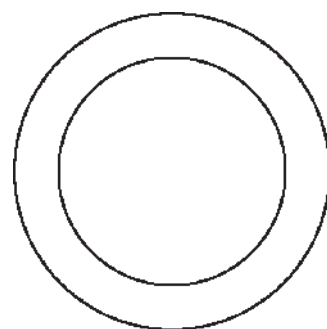
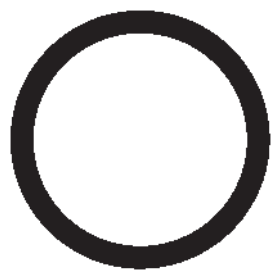

# NYLON & FIBER WASHERS

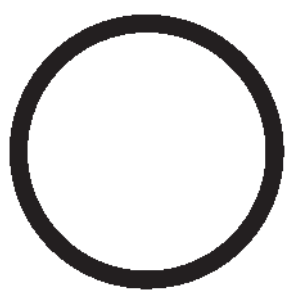
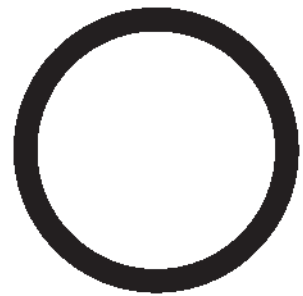
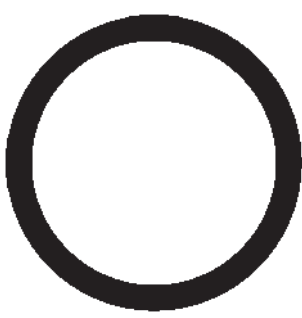
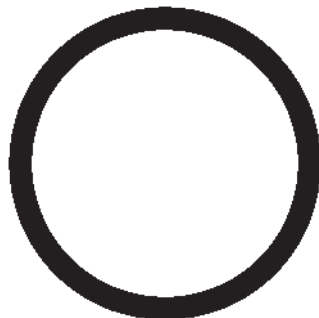
DANCO #	KIRK #	P&M #	DANCO #	KIRK #	P&M #	DANCO #	KIRK #	P&M #
					<b>17734, 17730</b>			<b>17747</b>
I.D. 1" 1.020	O.D. 1-13/16 1.800	THICK 1/32 0.030	I.D. 1-1/16 1.060	O.D. 1 1/4 1.250	THICK 1/8 0.120	I.D. 1-1/16 1.060	O.D. 1-1/2 1.470	THICK 1/32 0.030
								
Price Pfister PP950-200 (Nylon)			Briggs, Gerber Diverter, Price Pfister Speakman, Sterling Diverter (Fiber)			Sloan A-31 Handle Gasket (Nylon)		
LASCO# <b>02-7500</b>			<b>49</b>			LASCO# <b>02-1858</b>		
<b>49</b>			<b>50</b>			<b>51</b>		
I.D. 1-1/8 1.120	O.D. 1-3/8 1.360	THICK 1/32 0.030	I.D. 1-3/16 1.170	O.D. 1-1/2 1.480	THICK 1/16 0.060	I.D. 1-1/4 1.250	O.D. 1-7/16 1.440	THICK 1/16 0.060
								
(Fiber)			(Fiber)			(Fiber)		
LASCO# <b>02-1950</b>			<b>52</b>			LASCO# <b>02-1954</b>		
<b>52</b>			<b>54</b>			<b>55</b>		
I.D. 1-1/4 1.250	O.D. 1-1/2 1.500	THICK 1/32 0.030	I.D. 1-5/16 1.280	O.D. 1-9/16 1.550	THICK 1/16 0.060	I.D. 1-3/8 1.390	O.D. 1-5/8 1.630	THICK 1/32 0.030
								
(Fiber)			(Fiber)			Case Vent Cap, Sloan (Fiber)		
LASCO# <b>02-1852</b>			<b>56</b>			LASCO# <b>02-1830</b>		
<b>56</b>			<b>57</b>			<b>58</b>		

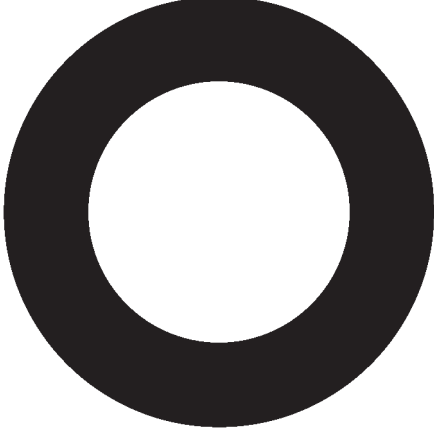
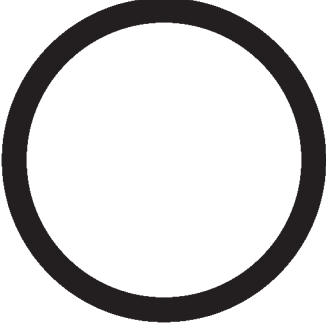
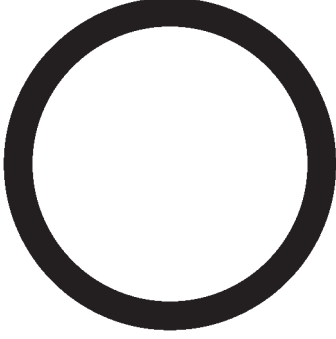
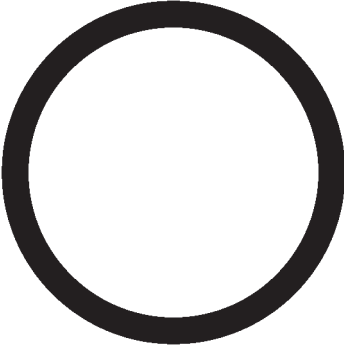

# NYLON & FIBER WASHERS

DANCO #	KIRK #	P&M #	DANCO #	KIRK #	P&M #
I.D. 1-3/8 1.370	O.D. 2-1/4 2.250	THICK 1/32 0.030	I.D. 1-7/16 1.440	<b>W-422A</b> O.D. 1-11/16 1.700	THICK 1/16 0.060
					
American Standard (Fiber)			(Fiber)		
LASCO# <b>02-7610</b>			LASCO# <b>02-1828</b>		
<b>59</b>			<b>60</b>		
I.D. 1-7/16 1.440	O.D. 1-3/4 1.740	THICK 1/8 0.120	I.D. 1-1/2 1.520	O.D. 1-13/16 1.800	THICK 1/32 0.030
					
Sink Connection Washer (Fiber)			Champion 1" Bonnet Gasket (Fiber)		
LASCO# <b>02-2056</b>			LASCO# <b>15-9610</b>		
<b>61</b>			<b>62</b>		

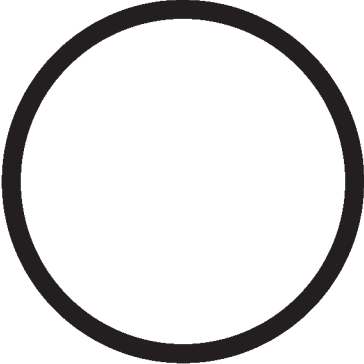
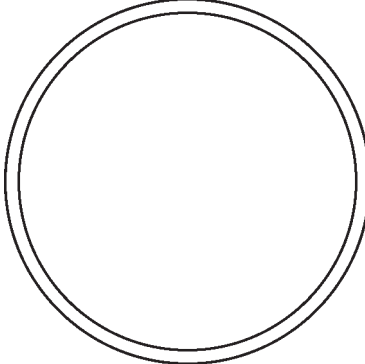
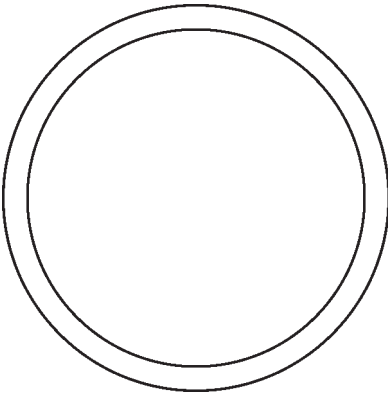
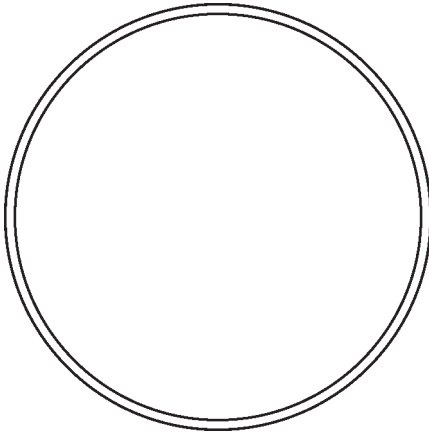

# NYLON & FIBER WASHERS

DANCO #	KIRK #	P&M #	DANCO #	KIRK #	P&M #
I.D. 1-11/16 1.700	O.D. 1-15/16 1.900	THICK 1/32 0.030	I.D. 1-3/4 1.750	O.D. 1-7/8 1.890	THICK 1/16 0.070
					
(Fiber)			Price Pfister PP949-120 (Nylon)		
LASCO# <b>02-1854</b>		<b>63</b>	LASCO# <b>02-1886</b>		<b>64</b>
DANCO #	KIRK #	P&M #	DANCO #	KIRK #	P&M #
I.D. 1-3/4 1.750	O.D. 2" 2.000	THICK 1/32 0.030	I.D. 2-1/8 2.110	O.D. 2-7/32 2.210	THICK 1/32 0.030
					
Price Pfister PP949-150 (Nylon)			American Standard Spout Friction Ring 37961-07 (Nylon)		
LASCO# <b>02-1884</b>		<b>65</b>	LASCO# <b>02-7600</b>		<b>53</b>



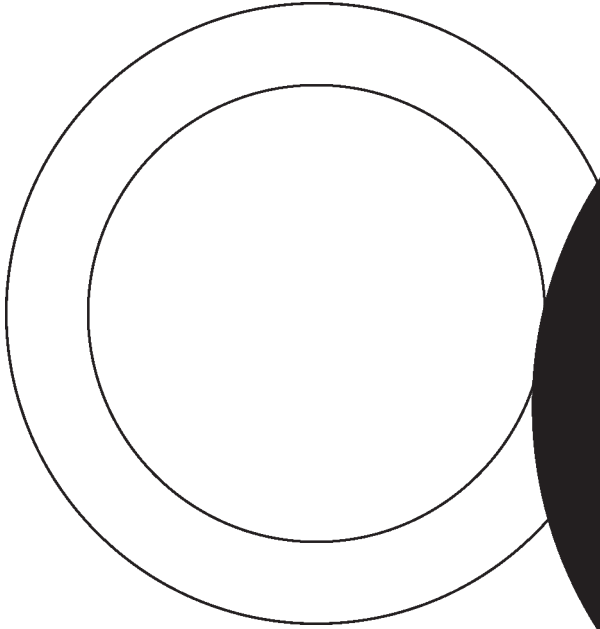
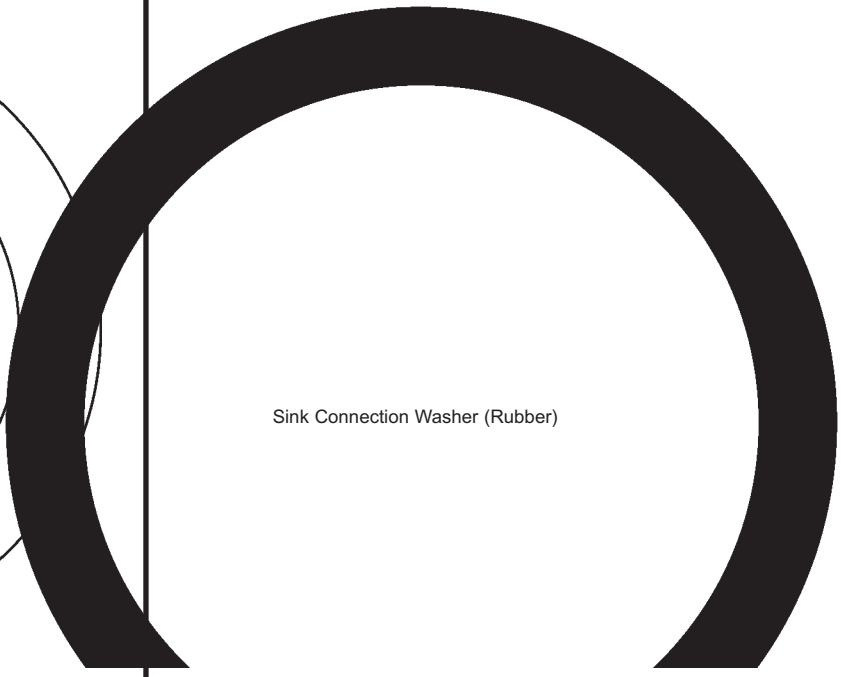
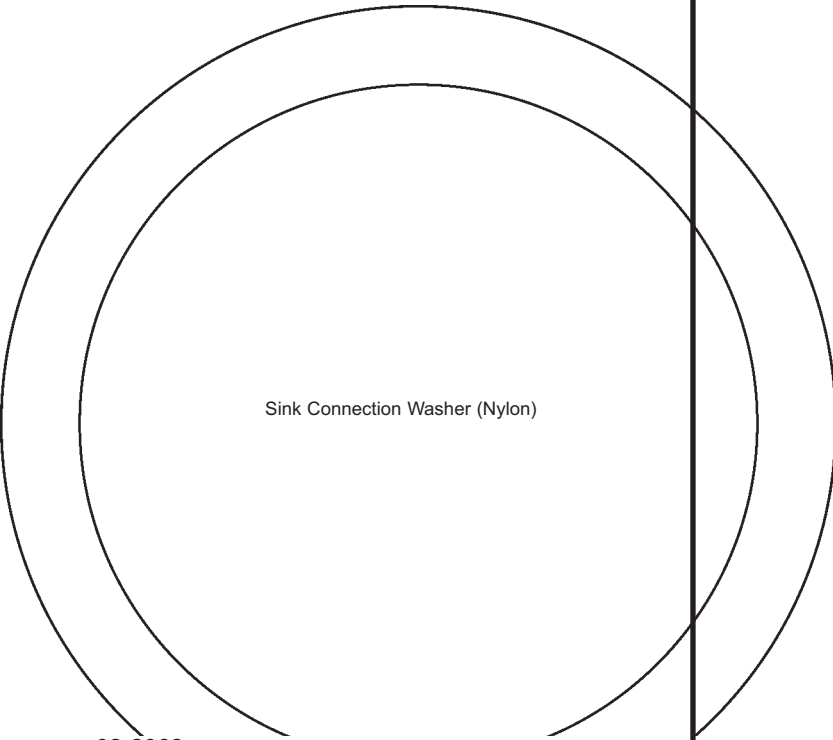

# NYLON & FIBER WASHERS

DANCO #	KIRK #	P&M #	DANCO #	KIRK #	P&M #
	<b>W-423A</b>			<b>W-257</b>	
I.D. 2-3/8 2.375	O.D. 3-7/32 3.225	THICK 1/32 0.030	I.D. 3-17/32 3.520	O.D. 4-11/32 4.340	THICK 1/8 0.120
 <p>Sink Connection Washer (Nylon)</p>			 <p>Sink Connection Washer (Rubber)</p>		
LASCO# <b>02-2070</b>			LASCO# <b>02-2066</b>		
	<b>W-258</b>				
I.D. 3-17/32 3.525	O.D. 4-11/32 4.340	THICK 1/32 0.042			
 <p>Sink Connection Washer (Nylon)</p>					
LASCO# <b>02-2068</b>					
		<b>66</b>			<b>67</b>
		<b>68</b>			



# FITTING WASHERS

POP	SIZE	I.D.	O.D.	BULK	CTN.	12/Pack	PCS	UPC	PCS	2 Per Card	CTN.
-----	------	------	------	------	------	---------	-----	-----	-----	------------	------

## UNION WASHERS

1	3/8	5/8	15/16	02-2004	100	02-2004D	1	02-2004P	10	02-2005	6
2	1/2	3/4	1-3/16	02-2006	100	02-2006D	1	02-2006P	10	02-2007	6
4	3/4	15/16	1-3/8	02-2010	100	02-2010D	1	02-2010P	10	02-2011	6
5	3/4 OS	1"	1-1/2	02-2012	100	02-2012D	1	02-2012P	10	02-2013	6
6	1"	1-1/8	1-5/8	02-2014	100	02-2014D	1	02-2014P	10	02-2015	6
7	1" OS	1-1/4	1-13/16	02-2016	100	02-2016D	1	02-2016P	10	02-2017	6
9	1-1/4	1-1/2	2-1/8	02-2018	100	02-2018D	1	02-2018P	10	02-2019	6
10	1-1/2	1-11/16	2-7/16	02-2020	100	02-2020D	1	02-2020P	10	02-2021	6
11	2"	2-3/16	2-13/16	02-2022	100	02-2022D	1	02-2022P	10	02-2023	6



09-6500

02-2004  
thru  
02-2023

SIZE	BULK	CTN.	12/Pack	PCS	UPC	PCS	2 Per Card	CTN.
------	------	------	---------	-----	-----	-----	------------	------

## GASKETS FOR COMPRESSION UNIONS

1/2" Copper Brass Union	13-1548	12				13-1549	6	
1/2" IPS Brass Union	13-1550	12			13-1550P	10	13-1551	6
3/4" IPS Brass Union	13-1552	12			13-1552P	10	13-1553	6
1" IPS Brass Union	13-1554	12			13-1554P	10	13-1555	6
1-1/4" IPS Brass Union	131556	12			13-1556P	10	13-1557	6
1-1/2" IPS Brass Union	13-1558	12			13-1558P	10	13-1559	6
2" IPS Brass Union	13-1560	12			13-1560P	10	13-1561	6
1/2" IPS PVC Union	13-1480	12			13-1480P	10	13-1481	6
3/4" IPS PVC Union	13-1482	12			13-1482P	10	13-1483	6
1" IPS PVC Union	13-1484	12			13-1484P	10	13-1485	6
1-1/4" IPS PVC Union	13-1486	12			13-1486P	10	13-1487	6
1-1/2" IPS PVC Union	13-1488	12			13-1488P	10	13-1489	6
2" IPS PVC Union	13-1490	12			13-1490P	10	13-1491	6
2-1/2" IPS PVC Union	13-1492	12						



13-1548  
thru  
13-1561



13-1480  
thru  
13-1491

SIZE	I.D.	O.D.	THICK	BULK	CTN.	12/Pack	PCS	UPC	PCS	2 Per Card	CTN.
------	------	------	-------	------	------	---------	-----	-----	-----	------------	------

## WATERMETER COUPLING WASHER

5/8"	5/8	15/16	1/8	26-9012	12			26-9012P	10	26-9013	6
3/4"	3/4	1-3/16	1/8	26-9014	12			26-9014P	10	26-9015	6
1"	1	1-1/2	1/8	26-9016	12			26-9016P	10	26-9017	6



26-9012  
thru  
26-9017

SIZE	I.D.	O.D.	BULK	PCS	UPC	PCS
------	------	------	------	-----	-----	-----

## DIELECTRIC UNION WASHER

1/2 FX				18-5830	10	18-5830P	10
1/2 EA or 3/4 FX				18-5850	10	18-5850P	10
3/4 EA				18-5855	10	18-5855P	10
1" FX				18-5860	10	18-5860P	10
1" EA				18-5865	10		
3/4 x 1/2 EA				18-5870	10		



18-5830  
thru  
18-5870

SIZE	I.D.	O.D.	BULK	PCS	UPC	PCS
------	------	------	------	-----	-----	-----

## SHOWER HOSE/KITCHEN HOSE WASHER

1/2"	3/4	1/16	1/8	08-1978	12			08-1979	6	
1"	1	1-1/2	1/8	09-6500	12			09-6501	6	



# FITTING WASHERS

SIZE	BULK	PCS			
<b>DIELECTRIC UNION INSULATOR</b>					
1/2 FX	18-5930	10			
3/4 FX or 1/2 EA	18-5950	10			
1" FX or 3/4 EA	18-5960	10			
1-1/4 FX or 1" EA	18-5962	10			

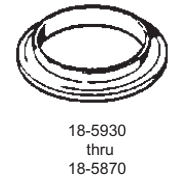

DESCRIPTION	BULK	PCS	UPC	PCS	1 Per Card	CTN.
-------------	------	-----	-----	-----	------------	------

## WATER HEATER ELEMENT GASKETS

Round head element gasket 1-1/8 I.D. 1-5/8 O.D. • 3/16" Thick	40-1530	1				
Screw-in element gasket 1-1/4 I.D. 1-1/2 O.D. • 1/8" Thick	40-1532	1	40-1532P	1	40-1533	6
4-bolt flat flange round gasket 1-5/8 O.D. • 1/2" Thick	40-1536	1			40-1537	6
Round gasket • Fits A.O. Smith water heater 1-3/4 O.D. • 3/8" Thick	40-1538	1				
Gasket • Fits National water heater	40-1540	1				
Molded round head gasket 1-5/8 O.D. • 3/16" Thick	40-1542	1				
Round 4-bolt universal flange 1-5/8 O.D. • 5/16" Thick	40-1544	1				
Four-hole gasket	40-1548	1				

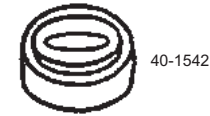
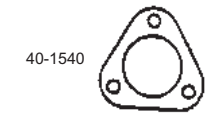

DESCRIPTION	BULK	PCS	UPC	PCS	2 Per Card	CTN.
-------------	------	-----	-----	-----	------------	------

## WATER HEATER FLEX WASHER

Brass Craft Double Beveled	10-1402	25	10-1402P	2	10-1403	6
Roberts Single Bevel	10-1406	25	10-1406P	2	10-1407	6

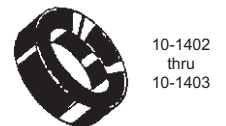
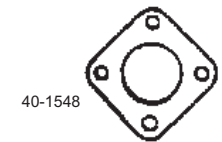

POP	I.D.	O.D.	THICK	BULK	CTN.	UPC	PCS	2 Per Card	CTN.
-----	------	------	-------	------	------	-----	-----	------------	------

## SPRINKLER VALVE WASHERS

	21/32	1-3/8	1/16	02-1856	12	02-1856P	10	02-1857	6
W-60A	7/32	15/16	1/4	02-2660	12	02-2660P	10	02-2661	6
W-60	7/32	1"	1/4	02-2662	12	02-2662P	10	02-2663	6
<b>W-60 Same as above (12 Pack)</b>							02-2662D	1	
W-60B	7/32	1-1/16	1/4	02-2664	12	02-2664P	10	02-2665	6
W-61A	7/32	1-1/8	1/4	02-2666	12	02-2666P	10	02-2667	6
W-61	7/32	1-1/4	1/4	02-2668	12	02-2668P	10	02-2669	6
W-62	7/32	1-3/8	1/4	02-2670	12	02-2670P	10	02-2671	6
W-62A	7/32	1-1/2	1/4	02-2672	12	02-2672P	10	02-2673	6
W-63	7/32	1-9/16	1/4	02-2674	12	02-2674P	10	02-2675	6



# ASSORTED WASHERS



Garden Valve Washers

POP	I.D.	O.D.	THICK	BULK	CTN.	UPC	PCS	2 Per Card	CTN.
<b>GARDEN VALVE WASHERS</b>									
W-220	3/16	1"	1/8	02-2700	12	02-2700P	10	02-2701	6
<b>W-220 Same as above (12 Pack)</b>				<b>Leather</b>		02-2700D	1		
W-221	3/16	1-1/8	1/8	02-2702	12	02-2702P	10	02-2703	6
<b>W-221 Same as above (12 Pack)</b>				<b>Leather</b>		02-2702D	1		
W-220AS	3/16	15/16	1/8	02-2714	12	02-2714P	10	02-2715	6
<b>W-220AS Same as above (12 Pack)</b>				<b>Rubber</b>		02-2714D	1		
W-220A	3/16	1"	1/8	02-2716	12	02-2716P	10	02-2717	6
<b>W-220A Same as above (12 Pack)</b>				<b>Rubber</b>		02-2716D	1		



02-1754 thru 02-1755

02-1890 thru 02-1890P



DESCRIPTION	BULK	CTN.	UPC	PCS	2 Per Card	CTN.
-------------	------	------	-----	-----	------------	------

## BALLCOCK WASHERS AND PARTS

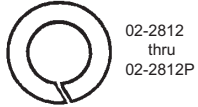

02-2812 thru 02-2812P

Flat seat hinge washers	02-1754	12	02-1754P	12	02-1755	6
Amer Std 233-17 plunger washer	02-1890	12	02-1890P	12		
W-36 Split leather 15/32 x 3/4	02-2812	12	02-2812P	12		
W-27 Ballcock repair parts kit	02-2820	24				
W-1A 7/16 x 1/8 Solid ballcock washer	02-2840	12				
W-1 1/2 x 1/8 Solid ballcock washer	02-2844	12	02-2844P	12		
W-1C 17/32 x 1/8 Solid ballcock washer	02-2846	12				
W-2 9/16 x 1/8 Solid ballcock washer	02-2848	12				
W-3 5/8 x 1/8 Solid ballcock washer	02-2850	12				
W-8 33/64 x 9/64 For Coast	02-2860	12	02-2860P	12		
W-11 1/2 x 3/16 For Mansfield	02-2866	12	02-2866P	12		
W-12 31/64 x 1/8 For Scovill	02-2868	12				
W-13 American Standard 73070-07	02-2870	12	02-2870P	12		

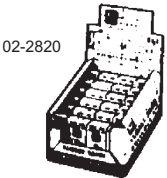

02-2820



02-2840 thru 02-2868

DESCRIPTION	BULK	CTN.	UPC	PCS	1 Per Card	CTN.
-------------	------	------	-----	-----	------------	------

## SHANK WASHERS



02-2870 thru 02-2870P

W-30 Ballcock shank washer	02-2880	12	02-2880P	12	02-2881	6
----------------------------	---------	----	----------	----	---------	---



02-2880 thru 02-2881

## BALLCOCK WASHERS

W-18 7/16 x 1/8 Coast Magic	02-2888	12	02-2888P	12		
W-19 17/32 x 1/8 Eljer	02-2900	12				
W-21 9/16 x 1/8 x 1/8	02-2904	12	02-2904P	12		
W-23 27/32 x 5/16 x 1/8	02-2908	12				
W-38 Rubber supply washer	02-2906	12				
W-39 C.I. rubber supply washer	02-2910	12				
W-37A Leather supply washer	02-2918	12				



02-2888 thru 02-2918



02-2980

DESCRIPTION	BULK	CTN.	UPC	PCS
-------------	------	------	-----	-----

## BALLCOCK CUP WASHERS



02-2982 thru 02-2984

W-43 Amer Std Leather cup washer	02-2980	12		
W-42 Amer Std Rubber cup washer	02-2982	12	02-2982P	12
Case cup washer 32-50	02-2984	12		
Case seat washer 47-50	02-2986	12	02-2986P	12
Case cup washer 62-12A	02-2988	12		



02-2986



02-2988



# ASSORTED WASHERS

POP	DESCRIPTION	BULK	CTN.	12/PACK	PCS.	UPC	PCS	2 Per CARD	CTN.	
<b>SINK CONNECTION WASHERS</b>										
	I.D.	O.D.								
<b>Flanged Plastic</b>										
W-251	1-5/16	1-23/32	02-2050	100	02-2050D	1	02-2050P	10	02-2051	6
<b>Cloth Inserted Rubber</b>										
W-251A	1-5/16	1-3/4	02-2052	100	02-2052D	1	02-2052P	10	02-2053	6
W-251B	1-1/8	1-1/2	02-2054	100	02-2054D	1	02-2054P	10	02-2055	6
<b>Fiber</b>										
W-252	1-7/16	1-3/4	02-2056	100			02-2056P	10	02-2057	6
<b>Rubber</b> <b>Note: Item 02-2059 is only 1 Per Card</b>										
W-253	1-7/8	2-1/2	02-2058	100			02-2058P	10	02-2059	6
W-257	3-1/2	4-3/8	02-2066	100	02-2066D	1	02-2066P	10		
<b>Nylon</b>										
W-258	3-1/2	4-3/8	02-2068	100	02-2068D	1	02-2068P	10		
Note: (1 each of W-257 & W-258 Carded)								02-2067	6	

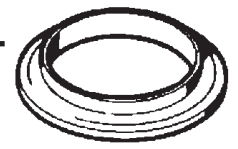

02-2050  
thru  
02-2051



02-2052  
thru  
02-2059



02-2066  
thru  
02-2066P

POP	DESCRIPTION	BULK	CTN.	12/PACK	PCS.	UPC	PCS	2 Per CARD	CTN.
<b>SLIP JOINT WASHERS RUBBER</b>									
W-304	1-1/4 Standard	02-2250	100	02-2250D	1	02-2250P	10	02-2251	6
W-304A	1-1/4 Medium	02-2252	100	02-2252D	1	02-2252P	10	02-2253	6
W-308	1-1/4 Shallow	02-2264	100	02-2264D	1	02-2264P	10	02-2265	6
W-305	1-1/2 Standard	02-2254	100	02-2254D	1	02-2254P	10	02-2255	6
W-305	12 Pack Carded			02-2255D	6				
W-305A	1-1/2 Medium	02-2256	100	02-2256D	1			02-2257	6
W-311	1-1/2 Shallow	02-2270	100	02-2270D	1				
W-306	2" Standard	02-2258	100	02-2258D	1	02-2258P	10	02-2259	6
W-306A	2" Heavy	02-2260	100						
W-309	1-1/2 x 1-1/4	02-2266	100	02-2266D	1	02-2266P	10	02-2267	6
W-310	1-1/2 x 1-3/8	02-2268	100					02-2269	6
W-309A	2 x 1-1/2	02-2262	100					02-2263	6
<b>SLIP JOINT WASHERS PLASTIC</b>									
W-304P	1-1/4 Poly	02-2280	100	02-2280D	1	02-2280P	10	02-2281	6
W-305P	1-1/2 Poly	02-2282	100	02-2282D	1	02-2282P	10	02-2283	6
W-306P	2" Poly	02-2284	100					02-2285	6
W-309P	1-1/2 x 1-1/4	02-2286	100	02-2286D	1	02-2286P	10	02-2287	6
ASSORTED 8 Per Card								02-2289	6

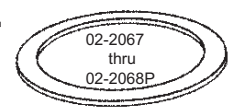

02-2067  
thru  
02-2068P

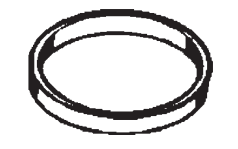

Rubber Slip Joint Washers



02-2262  
02-2263

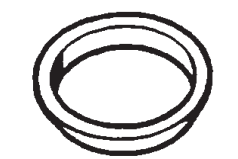

Plastic Slip Joint Washers

POP	DESCRIPTION	BULK	CTN.	12/PACK	PCS	UPC	PCS	2 Per CARD	CTN.
<b>SOLUTION WASHERS • With "PASSION GRIP"</b>									
W-304S	1-1/4 Slip Joint	02-2290	100	02-2290D	1			02-2291	6
W-305S	1-1/2 Slip Joint	02-2292	100	02-2292D	1			02-2293	6
W-309S	1-1/2 x 1-1/4 SJ	02-2296	100	02-2296D	1			02-2297	6
W-251S	Flange Tailpiece	02-2294	100	02-2294D	1			02-2295	6





























02-2290  
thru  
02-2297



02-2294  
thru  
02-2295

# ASSORTED WASHERS

POP	NUT	TUBE	NAME	BULK	CTN.	12/PACK	PCS	UPC	PCS	4 Per CARD	CTN.
<b>CONE WASHERS</b>											
	02-2200 thru 02-2201	#1	1/2 3/8 Speedy	02-2200	100	02-2200D	1	02-2200P	10	02-2201	6
	02-2202 thru 02-2203	#2	1/2 3/8 W-276	02-2202	100	02-2202D	1	02-2202P	10	02-2203	6
	02-2204 thru 02-2205	#3	1/2 3/8 W-277	02-2204	100	02-2204D	1	02-2204P	10	02-2205	6
	02-2226 thru 02-2227	#4	1/2 3/8 Stepped	02-2226	100	02-2226D	1	02-2226P	10	02-2227	6
	02-2204 thru 02-2205	#5	1/2 7/16 W-277A	02-2206	100	02-2206D	1	02-2206P	10	02-2207	6
	02-2226 thru 02-2227	#6	1/2 7/16 Shallow	02-2210	100	02-2210D	1	02-2210P	10	02-2211	6
	02-2226 thru 02-2227	#7	1/2 1/2 W-278	02-2208	100	02-2208D	1	02-2208P	10	02-2209	6
	02-2206 thru 02-2207	#8	1/2 1/2 W-283	02-2220	100	02-2220D	1	02-2220P	10	02-2221	6
	02-2206 thru 02-2207	#9	B/C 3/8 W-285	02-2224	100	02-2224D	1	02-2224P	10	02-2225	6
	02-2210 thru 02-2211	#10	B/C 3/8 Stepped	02-2228	100	02-2228D	1	02-2228P	10	02-2229	6
	02-2210 thru 02-2211	#11	B/C 7/16 W-280	02-2212	100	02-2212D	1	02-2212P	10	02-2213	6
	02-2210 thru 02-2211	#12	B/C 7/16 W-281	02-2214	100	02-2214D	1	02-2214P	10	02-2215	6
	02-2210 thru 02-2211	#13	B/C 1/2 W-282A	02-2218	100	02-2218D	1	02-2218P	10	02-2219	6
	02-2208 thru 02-2209	#14	7/8 9/16 Bath Supply	02-2216	100	02-2216D	1	02-2216P	10	02-2217	6
	02-2208 thru 02-2209	#15	B/C 11/16 W-284	02-2222	100	02-2222D	1	02-2222P	10	02-2223	6
	02-2220 thru 02-2221	#16	1/2 Thread-On	02-2240	100	02-2240D	1	02-2240P	10	02-2241	6
	02-2220 thru 02-2221	#17	B/C Thread-On	02-2242	100	02-2242D	1	02-2242P	10	02-2243	6
	02-2220 thru 02-2221	#18	B/C Poly Nose	02-2244	100	02-2244D	1	02-2244P	10	02-2245	6

POP	NUT	TUBE	NAME	BULK	CTN.	12/PACK	PCS	UPC	PCS	2 Per CARD	CTN.
<b>BRASS FRICTION RINGS FOR CONE WASHERS</b>											
	02-2228 thru 02-2229	A	1/2 3/8 R-14	02-2326	100	02-2326D	1	02-2326P	10	02-2327	6
	02-2212 thru 02-2213	B	3/8 7/16 R-1	02-2300	100	02-2300D	1	02-2300P	10	02-2301	6
	02-2214 thru 02-2215	C	1/2 7/16 R-2	02-2302	100	02-2302D	1	02-2302P	10	02-2303	6
	02-2218 thru 02-2219	D	1/2 1/2 R-3	02-2304	100	02-2304D	1	02-2304P	10	02-2305	6
	02-2216 thru 02-2217	E	B/C 3/8 R-15	02-2328	100	02-2328D	1	02-2328P	10	02-2329	6
	02-2216 thru 02-2217	F	B/C 7/16 R-4	02-2306	100	02-2306D	1	02-2306P	10	02-2307	6
	02-2222 thru 02-2223	G	B/C 1/2 R-5	02-2308	100	02-2308D	1	02-2308P	10	02-2309	6
	02-2222 thru 02-2223	H	13/16 3/8 R-12	02-2322	100						

DESCRIPTION	CARD	CTN.
7 Piece Assorted Cone Washers Carded	02-2231	6
For 7/16 S/J Nut 2/Friction Rings & 2/Cone Washers	02-2233	6
For 7/16 B/C Nut 2/Friction Rings & 2/Cone Washers	02-2235	6
For 3/8 B/C Nut 2/Friction Rings & 2/Cone Washers	02-2237	6
10 Piece Assorted Friction Rings Carded	02-2333	6





# ASSORTED WASHERS

POP	I.D.	O.D.	NAME	BULK	CTN	KIRKHILL	P&M
<b>OTHER BRASS FRICTION RINGS</b>							
1	13/32	2-3/16	American Standard	AS64704-07	100		
2	7/16	3/4		02-1664	100	P-98-14	
3	13/32	25/32		02-1672	100	P-98-19	
4	15/32	3/4		02-1660	100	P-98-12	
5	1/2	13/16	Kohler	KO-34265	100		
6	1/2	7/8		02-1662	100	P-98-13	
7	19/32	3/4		02-1654	100	P-98-8	
8	11/16	7/8		02-1658	100	P-98-10	
9	23/32	3/4	UR Cap Gasket	02-1832	100		
10	23/32	13/16	Kohler	KO-22132	100		17643
11	1-1/4	1-1/2	R-6	02-2310	100	R-6	
12	1-1/4	1-3/4	R-7	02-2312	100	R-7	
13	1-3/8	1-3/4	R-9	02-2316	100	R-9	
14	1-1/2	1-3/4	R-8	02-2314	100	R-8	
15	2"	2-3/16	R-10	02-2318	100	R-10	
	5/16	15/32	American Standard	AS29103-07	100		

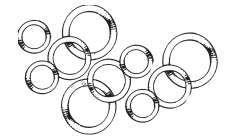

Friction Rings

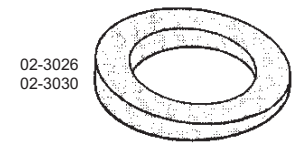

POP	DESCRIPTION	BULK	CTN	UPC	CTN 1 PerCARD	CTN
-----	-------------	------	-----	-----	---------------	-----

## WASTE & OVERFLOW WASHERS

### SPONGE GASKETS

W-503	Regular Sponge Gasket	02-3026	12	02-3026P	10	02-3027	6
W-507	Flat Sponge Gasket	02-3034	12	02-3034P	10	02-3035	6
W-505	Large ID Sponge Gasket	02-3030	12	02-3030P	10	02-3031	6

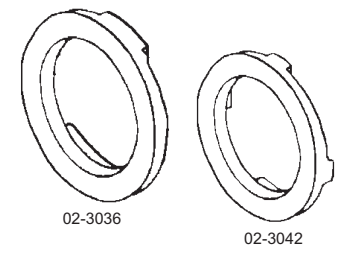

### HARD RUBBER

	I.D.	O.D.	THICK	BULK	CTN	UPC	CTN 1 PerCARD	CTN	
W-500	1-7/8	2-15/16	9/32-1/8	02-3020	12	02-3020P	10	02-3021	6
W-501	2-5/16	3-3/16	3/16-5/64	02-3022	12			02-3023	6
W-502	2-1/4	2-15/16	1/4-1/8	02-3024	12	02-3024P	10	02-3025	6
W-504	2-3/8	3"	9/32-5/32	02-3028	12	02-3028P	10	02-3029	6



### SPECIAL WASTE & OVERFLOW WASHERS

Two Ear Gasket	02-3036	12	02-3036P	10	02-3037	6
Four Ear Gasket for Price Pfister	02-3042	12			02-3043	6
91-150 Gerber Gasket	02-3044	12			02-3045	6



### BATH SHOE WASHERS

W-506	1-3/4	2-5/8		02-3032	12	02-3032P	10	02-3033	6
			Thick Rubber for 1-1/4"	02-3038	12			02-3039	6
			Thick Rubber for 1-1/2"	02-3040	12			02-3041	6
W-507			Sponge Rubber	02-3034	12	02-3034P	10	02-3035	6



DESCRIPTION	BULK	CTN	1 PerCARD	CTN
-------------	------	-----	-----------	-----

### BALL JOINT WASHERS FOR SHOWER HEADS

Washer for Water-Saver	08-2542	12		08-2543	6
Import Ball Joint Washer	02-2080	12		02-2081	6
W-44S Small Ball Joint Washer	02-2082	12		02-2083	6
W-44M Medium Ball Joint Washer	02-2084	12		02-2085	6
W-44L Large Ball Joint Washer	02-2086	12		02-2087	6
Price Pfister Ball Joint O-Ring	02-2090	12		02-2091	6
Speakman Ball Joint Washer	02-2092	12		02-2093	6



# ASSORTED WASHERS



02-3050  
thru  
02-3061

POP	DESCRIPTION	BULK	CTN	UPC	CTN 1	PerCARD	CTN
-----	-------------	------	-----	-----	-------	---------	-----

## FLANGED SPUD WASHERS

02-3070  
thru  
02-3073



W-316	1" Spud Washer	02-3050	12		02-3051	6
W-320	1-1/4" Spud Washer	02-3052	12	02-3052P	02-3053	6
W-321	1-1/2" Spud Washer	02-3054	12	02-3054P	02-3055	6
W-322	2" Spud Washer	02-3056	12	02-3056P	02-3057	6
W-324	2" x 1-1/4" Spud Washer	02-3058	12		02-3059	6
W-325	2" x 1-1/2" Spud Washer	02-3060	12	02-3060P	02-3061	6

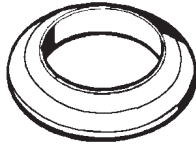

02-3120  
thru  
02-3123

## FLUSH VALVE WASHERS

02-3132  
thru  
02-3133



W-206	2-1/4 ID x 3-13/16 OD	02-3070	12	02-3070P	02-3071	6
W-205	2-3/8 ID x 3-1/8 OD	02-3072	12		02-3073	6



02-3124  
02-3124P

## CLOSE-COUPLED SPONGE GASKETS

### Tank to Bowl (Standard)

W-208	Regular Sponge Rubber	02-3120	12	02-3120P	02-3121	6
W-208A	Heavy Sponge Rubber	02-3122	12	02-3122P	02-3123	6

02-3126  
02-3126P



### Tank to Bowl (OEM)

W-210	Amer Std Recessed	02-3132	12	02-3132P	02-3133	6
W-208C	Crane 2-3/16 x 3-3/8	02-3124	12	02-3124P		
W-208G	Gerber 2-1/8 x 3-1/4	02-3126	12	02-3126P		
W-208S	Amer Std 2-1/4 x 3-3/16	02-3128	12			
W-209	Kohler 2-3/8 x 4-3/16	02-3130	12			
51531	Kohler 2-3/8 x 3-3/4	02-3110	12			
4333	Eljer 2-1/4 x 3-3/16	02-3136	12	02-3136P		
33541	Amer Std U-Gasket	02-3138	12	02-3138P		
5702	Eljer Round with Ears	02-3140	12	02-3140P		
51487	Kohler Triangle Gasket	02-3142	12	02-3142P		



02-3128



02-3110  
02-3130



02-3136  
02-3136P

**NOTE: See Page 4-10 For Gaskets with Bolts Kits**

02-3138  
02-3138P



## MACK PATTERN GASKETS

G-1	1-1/4 ID 2" OD Size 1-1/4	02-3080	12		02-3081	6
G-1A	1-1/4 ID 2-3/8 OD Size 1-1/4	02-3082	12	02-3082P	02-3083	6
G-2	1-5/16 ID 2-3/8 OD Size 1-5/16	02-3084	12		02-3085	6
G-3	1-3/8 ID 2" OD Size 1-3/8	02-3086	12	02-3086P	02-3087	6
G-4	1-7/16 ID 2-3/8 OD Size 1-1/2	02-3088	12	02-3088P	02-3089	6



02-3140  
02-3140P

02-3142  
02-3142P

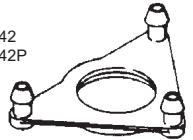

## SINK FUNNEL WASHERS



02-3080  
thru  
02-3089



02-3076  
thru  
02-3079

G-80	1-3/8 x 2-11/16	02-3076	12		02-3077	6
G-81	1-1/2 x 2-5/8	02-3078	12		02-3079	6





# STOPPERS & CHAIN

POP	DESCRIPTION	BULK	CTN	1 PerCARD	CTN
-----	-------------	------	-----	-----------	-----

## RUBBER STOPPER (Commercial Type)

	1-1/8 x 1-1/4 Black Commercial Stopper with Chain	02-3160	12	02-3161	6
--	---	---------	----	---------	---



## WHITE HOLLOW RUBBER STOPPERS

S-80	1" Hollow Stopper	02-3200	12	02-3201	6
S-81	1-1/8" Hollow Stopper	02-3202	12	02-3203	6
S-82	1-1/4" Hollow Stopper	02-3204	12	02-3205	6
S-83	1-3/8" Hollow Stopper	02-3206	12	02-3207	6
S-84	1-1/2" Hollow Stopper	02-3208	12	02-3209	6
S-85	1-5/8" Hollow Stopper	02-3210	12	02-3211	6
S-86	1-3/4" Hollow Stopper	02-3212	12	02-3213	6
S-87	1-7/8" Hollow Stopper	02-3214	12	02-3215	6
S-88	2" Hollow Stopper	02-3216	12	02-3217	6
S-61	1 x 1-3/8 Fit-All Stopper	02-3230	12	02-3231	6
S-62	1-1/2 x 2 Fit-All Stopper	02-3232	12	02-3233	6
S-95A	4-3/4" Flat Stopper	02-3310	12	02-3311	6

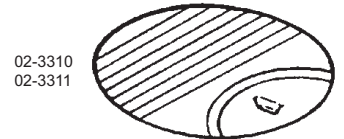
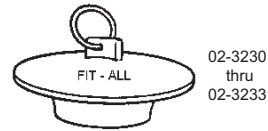
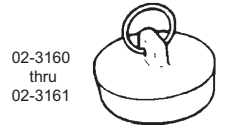

POP	DESCRIPTION	BULK	CTN	5 PerCARD	CTN
-----	-------------	------	-----	-----------	-----

## BEADED CHAIN COUPLINGS

#3-6	A-Type Brass	02-3360	100	02-3361	6
#3-6	A-Type Nickel Plated Brass	02-3362	100	02-3363	6
#8-10	A-Type Brass	02-3364	100	02-3365	6
#8-10	A-Type Nickel Plated Brass	02-3366	100	02-3367	6
#3	B-Type Brass	02-3380	100	02-3381	6
#3	B-Type Nickel Plated Brass	02-3382	100	02-3383	6
#6	B-Type Brass	02-3384	100	02-3385	6
#6	B-Type Nickel Plated Brass	02-3386	100	02-3387	6
#10	B-Type Brass	02-3392	100	02-3393	6
#10	B-Type Nickel Plated Brass	02-3394	100	02-3395	6

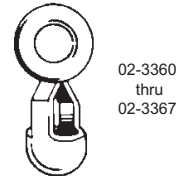

POP	DESCRIPTION	100' Brass	500' Brass	100' N.P.	500' N.P.
-----	-------------	------------	------------	-----------	-----------

## BEADED CHAIN (BULK)

#3	Beaded Chain	02-3400	02-3402	02-3404	02-3406
#6	Beaded Chain	02-3408	02-3410	02-3412	02-3414
#8	Beaded Chain			02-3470	02-3474
#10	Beaded Chain	02-3422	02-3424	02-3426	02-3428

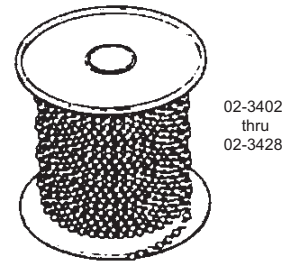

POP	DESCRIPTION	BULK	CTN	1 PerCARD	CTN
-----	-------------	------	-----	-----------	-----

R-20	Split Ring	02-3430	100		
R-21	Key Ring	02-3432	100		
C-30	11" Beaded Chain	02-3450	100	02-3451	6
C-31	15" Beaded Chain	02-3452	100	02-3453	6

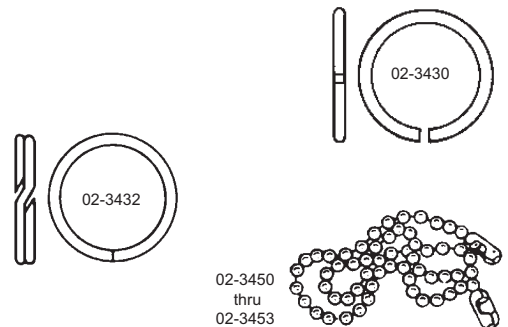

DISPOSAL PARTS



39-9000 - 39-9001  
39-9002 - 39-9003  
39-9056 - 39-9057



39-9052 - 39-9053  
39-9054 - 39-9055



02-4010 - 02-4011



39-9008 - 39-9009



39-9012 - 39-9013



39-9006 - 39-9007



39-9010 - 39-9011



39-9062 - 39-9063



39-9068 - 39-9069



02-4012 - 02-4013



39-9064 - 39-9065



39-9004 - 39-9005  
39-9036 - 39-9037



39-9032 - 39-9033



02-4021



39-9034 - 39-9035

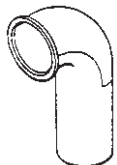

39-9018 - 39-9019  
03-4248 - 03-4249



39-9040 - 39-9041

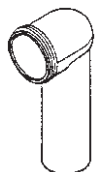

39-9058 - 39-9059



03-4219A



39-9060 - 39-9061

BULK NO.	CTN. QTY.	DESCRIPTION	CARDED NO.	CTN. QTY.
----------	-----------	-------------	------------	-----------

SPLASH GUARDS

39-9000	1	1010 333SS and up ISE models	39-9001	6
39-9002	1	1439 Badger and 333 ISE models	39-9003	6
39-9052	1	WKSG-2 Waste King fits 2600 and 2800 models	39-9053	6
39-9054	1	WKSG-3Waste King fits 5000 and 8000 models	39-9055	6
39-9056	1	Whirl-A-Way and Sinkmaster	39-9057	6
02-4010	1	Fit-All	02-4011	6

Note:

For other disposal parts see section 39 of catalog.

STOPPERS

39-9006	1	1876 2 piece metal ISE	39-9007	6
39-9008	1	5029 Stopper gasket ISE	39-9009	6
39-9010	1	5032 Chrome metal ISE	39-9011	6
39-9012	1	4310 Plastic ISE	39-9013	6
39-9062	1	WKSC-2 Waste King plastic	39-9063	6
39-9064	1	WKSC-3 Waste King metal	39-9065	6
39-9068	1	Whirl-A-Way and Sinkmaster	39-9069	6
02-4012	1	Fit-All Stopper	02-4013	6
		Fit-All Strainer	02-4021	6

CONNECTION PARTS AND ACCESSORIES

39-9004	1	1470 Hush cushion ISE	39-9005	6
39-9036	1	New style badger hush cushion	39-9037	6
39-9032	1	5490 Flange for elbow ISE	39-9033	6
39-9034	1	2593 Flange for new style badger	39-9035	6
39-9018	1	8219 Plastic elbow ISE	39-9019	6
		ISE New style elbow	03-4219A	6
03-4248	1	ISE 7" Long plastic elbow	03-4249	6
39-9040	1	ISE Wrench	39-9041	6
39-9058	1	WK-TP Waste King plastic elbow	39-9059	6
39-9060	1	75015 Waste King hush cushion	39-9061	6



TAPES

ITEM NO.	PACK	DESCRIPTION	CTN. QTY.
----------	------	-------------	-----------

**GREY FORCED AIR DUCT TAPE**

02-4102	Bulk	2" x 10 Yard	54
02-4104	Bulk	2" x 20 Yard	24
02-4106	Bulk	2" x 60 Yard	24

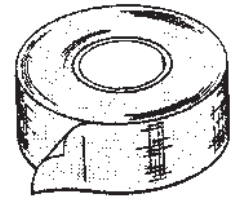

02-4102  
02-4104  
02-4106  
02-4108

**ALUMINUM FOIL TAPE**

02-4108	Bulk	2" x 50 Yard	24
---------	------	--------------	----

02-4180  
thru  
02-4200

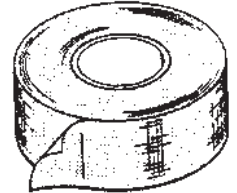

**COLORED FORCED AIR DUCT TAPE**

02-4180	Bulk	Black	2" x 60 Yard	24
02-4182	Bulk	Green	2" x 60 Yard	24
02-4184	Bulk	White	2" x 60 Yard	24
02-4186	Bulk	Blue	2" x 60 Yard	24
02-4188	Bulk	Red	2" x 60 Yard	24
02-4190	Bulk	Yellow	2" x 60 Yard	24
02-4192	Bulk	Brown	2" x 60 Yard	24
02-4194	Bulk	Teal Blue	2" x 60 Yard	24
02-4196	Bulk	Orange	2" x 60 Yard	24
02-4198	Bulk	Olive Draped	2" x 60 Yard	24
02-4200	Bulk	Tan	2" x 60 Yard	24

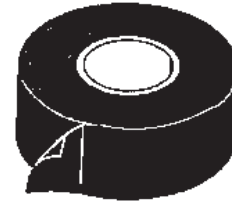

02-4118  
02-4122  
02-4124  
02-4120

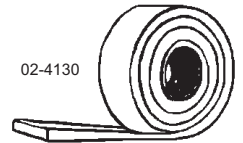

02-4130

**BLACK PIPE WRAP**



02-4118	Bulk	1" x 100 Foot • 10 Mil	48
02-4122	Bulk	2" x 100 Foot • 10 Mil	24
02-4124	Bulk	2" x 100 Foot • 20 Mil	24
02-4120	Bulk	4" x 100 Foot • 10 Mil	12

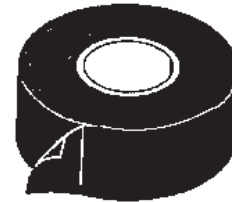

02-4132

**HANDI - CAP WRAP**

02-4130	Bulk	2" x 40 Foot white foam wrap to wrap pipes and valves to make them scald resistant	72
02-4132	Bulk	2" x 30 Foot black sticky foam tape 1/8" thick • For insulating pipes and fittings	72
02-4134	Bulk	6" x 200 Foot white flex wrap	24

02-4134

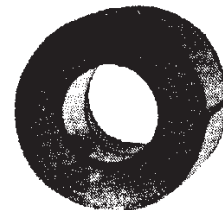

02-4138

**MAGIC WRAP**

02-4138	Carded	Magic wrap • For repair of pipes & hoses	12
---------	--------	--	----

**SHOWER DOOR SEAL**

02-4151	Carded	Grey 36" Shower door seal	6
---------	--------	---------------------------	---

02-4151

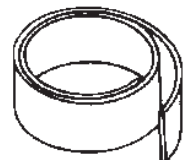

**SAFETY STRIPS**

02-4160	771	White tub safety strips	6
02-4162	ST11	White tub safety roll	6
02-4164	ST02	White tub safety fish appliques	6
02-4166	ST04	White tub safety shells appliques	6
02-4168	ST06	White tub safety marine appliques	6



02-4160  
thru  
02-4168



# CRUTCH TIPS & CASTER CUPS

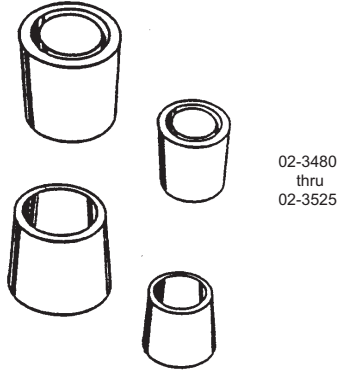

02-3480  
thru  
02-3525

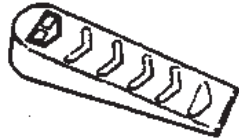

02-3536  
02-3537



02-3620  
thru  
02-3325

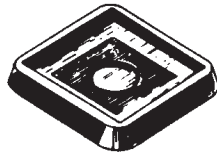

02-3624  
thru  
02-3627



02-3240  
02-3241



02-3252  
02-3254



02-3270  
thru  
02-3273



02-3282  
thru  
02-3287



02-3300  
02-3301

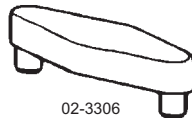

02-3306  
02-3307



02-3309

POP	SIZE	BLACK BULK	CTN.	WHITE BULK	CTN.	WHITE 4 PER CARD	CTN.
<b>CRUTCH TIPS</b>							
T-15	3/8"	02-3480	12	02-3510	12	02-3511	6
T-16	1/2"	02-3482	12	02-3512	12	02-3513	6
T-17	5/8"	02-3484	12	02-3514	12	02-3515	6
T-18	3/4"	02-3486	12	02-3516	12	02-3517	6
T-19	7/8"	02-3488	12	02-3518	12	02-3519	6
T-20	1"	02-3490	12	02-3520	12	02-3521	6
T-21	1-1/8"	02-3492	12	02-3522	12	02-3523	6
T-22	1-1/4"	02-3494	12	02-3524	12	02-3525	6

	BULK	CTN.	CARDED	CTN.
D-61	02-3536	12	02-3537	6

	BULK	CTN.	4 PER CARD	CTN.
C-61	1-1/4 x 1-7/8 Round	02-3622	12	02-3623 6
C-60	1-3/4 x 2-3/8 Round	02-3620	12	02-3621 6
C-63	1-3/16 x 1-13/16 Square	02-3326	12	02-3327 6
C-62	1-3/4 x 2-3/8 Square	02-3324	12	02-3325 6

		BULK	CTN.	CARDED	CTN.
B-36	Bumper Set W/Screws	02-3240	24	02-3241	6
B-34	2-1/4 x 7/16 x 1/2	02-3252	100		
B-38	2-1/4 x 7/16 x 7/8	02-3254	100		

		BULK	CTN.	4 PER CARD	CTN.
3/4"	Round Screw Bumper	02-3270	100	02-3271	6
1"	Round Screw Bumper	02-3272	100	02-3273	6
1/2"	Round Tack Bumper	02-3282	100	02-3283	6
5/8"	Round Tack Bumper	02-3284	100	02-3285	6
3/4"	Round Tack Bumper	02-3286	100	02-3287	6

		BULK	CTN.	2 PER CARD	CTN.
3/4"	Round Snap In	02-3300	100	02-3301	6
3/4" x 1-3/16"	Oval Snap In	02-3306	100	02-3307	6
3/4" Round & 1-3/16" Oval	Snap In Set (2 of each per Card)			02-3309	6

