



Brevia™ Quick-Release™

elongated toilet seat
K-4774

Features

- Elongated closed-front seat.
- Grip-Tight bumpers hold seat firmly in place.
- Quick-Release™ hinges allow seat to be unlatched from toilet for easy removal and convenient cleaning; no tools required.
- Color-matched plastic hinges.
- Contoured seat for user comfort.
- For residential use only.
- For non-residential application, use K-20112, K-20110, or K-7671.

Material

- Plastic.

Installation

- Quick-Attach® hardware for fast and secure installation.



Codes/Standards







None Applicable

KOHLER® One-Year Limited Warranty

See website for detailed warranty information.

Available Colors/Finishes

Color tiles intended for reference only.

Color	Code	Description
	0	White
	96	Biscuit
	47	Almond
	NY	Dune
	95	Ice™ Grey
	G9	Sandbar
	7	Black Black™

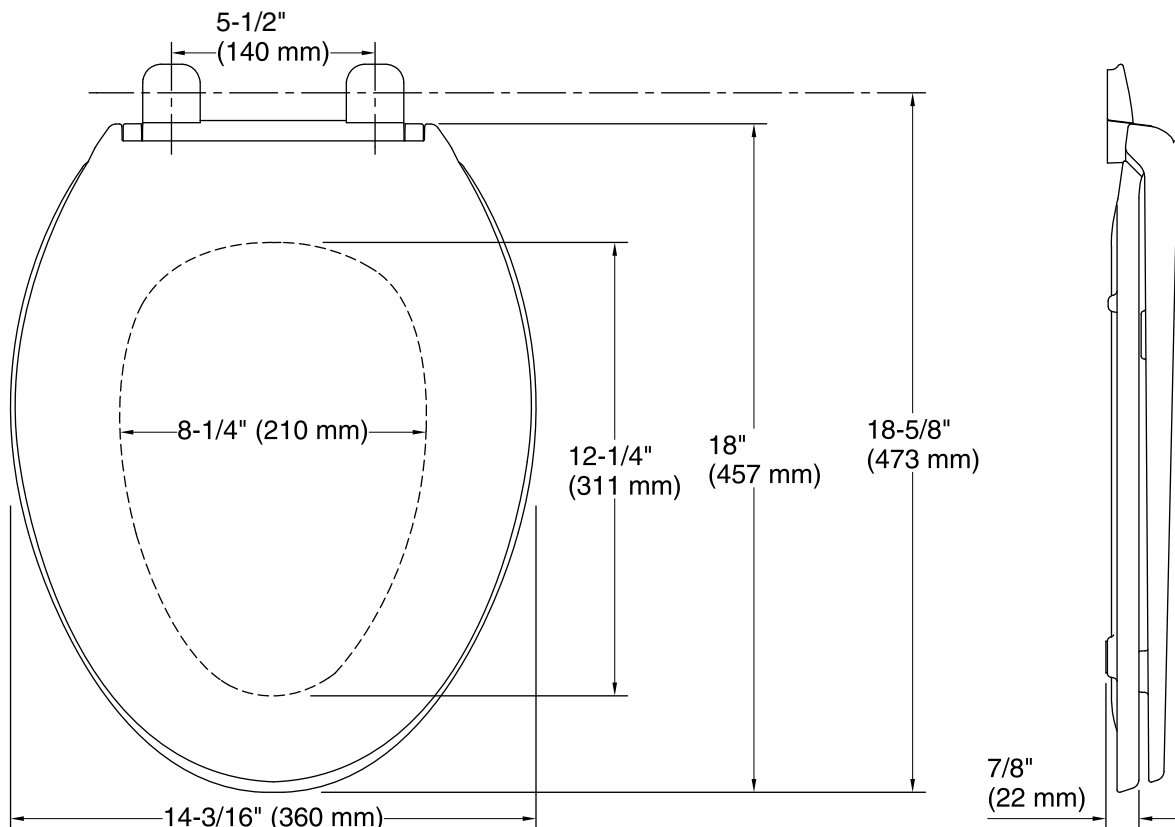

Technical Information

All product dimensions are nominal.

Seat shape type: Elongated

Seat front type: Closed-front

Seat-mounting holes: 5-1/2" (140 mm)

Notes

Install this product according to the installation guide.