



Shelving

Adjustable Wall Shelving Quick Reference Guide	80	Built-In Shelving and Shelf Supports	99		
Pilaster Shelving Systems	81	5mm Series Shelf Supports	99		
255/256 Series Mortise-Mount Pilaster Shelving Systems	81	5mm Series Vinyl Coated Shelf Supports	99		
233/237 Series Surface-Mount Pilaster Shelving System	83	1/4" Series Shelf Supports	99		
Regular-Duty Adjustable Shelving Systems	84	5mm Series Grommets	99		
70/170 Regular-Duty Standard and Bracket System	84	1/4" Series Grommets	100		
71/170 Regular-Duty Narrow Standard and Bracket System	84	7/32" Series Shelf Supports	100	Utility Shelving Brackets	101
80/180 Regular-Duty Standard and Bracket System	85	204 Series Heavy-Duty L-Bracket	101		
160LL/179/181 Series Specialty Brackets	87	206 Series Extra-Duty Folding L-Bracket	101		
79/7980 Easy Installation Hang Rail	88	208 Series Ultimate L-Bracket	102		
Heavy-Duty Adjustable Shelving Systems	89	221 Series Utility L-Bracket	102	Decorative Shelving Brackets	103
82/182 Series Heavy-Duty Standard and Bracket System	89	88 and 888 Series Wood Shelf Anchor	103		
79/7982 Easy Installation Hang Rail	90	215 Series Slim-Line™ Shelf Bracket	103		
83/183 Series Heavy-Duty Standard and Bracket System	91	216 Series Simplicity™ Shelf Bracket	103		
161LL Heavy-Duty Lock Lever Bracket	92	217 Series Silhouette™ Shelf Bracket	103		
Extra-Duty Adjustable Shelving System	93	200 Series Designer Decorative Shelf Brackets	105	Shelf Board	106
85/185 Series Extra-Duty Standard and Bracket System	93	1980 Series All-Purpose Shelf Board	106		
Super-Duty Adjustable Steel Shelving System	95				
1987 Series Galvanized Steel Shelving	95				
87/186/187 Series Super-Duty Standard and Bracket System	95				
1987 Series Stainless Steel Shelving	97				
87/186/187 Super-Duty Stainless Steel Standard and Bracket System	97				

Adjustable Wall Shelving Quick Reference Guide

Knap and Vogt pioneered the development of the modern standards and bracket system of adjustable wall shelving, and we're still the leader in selection, quality and innovation. With one of the industry's widest selection of systems and component accessories, chances are we make a shelving system just right for you. To aid your selection process, we've created a comparison chart that lists the vital characteristics of our standards and bracket systems, as well as available finishes and accessories. If you still have questions or need more details, please contact KV Customer Service.

Part	Description	Features					Finish Options										Pack Options							
		1" Center Adjustment	1-1/4" Center Adjustment	2" Center Adjustment	Single Track	Double Track	Lock Lever	Almond (ALM)	Anochrome (ANO)	Black (BLK)	Brass-look (BR)	Brown (BRN)	Clear (CL)	Stainless Steel (SS)	Galvanized Steel (GALV)	Titanium (TI)	White (WH)	Zinc (ZC)	Economy Zinc (E)	Standard Pack	Builders Pack (BP)	Display Pack (DP)	Heavy Pack (HP)	
70/170 Regular-Duty Adjustable Standard and Bracket System																								
70	Standard	•			•														•	•				
170E	Bracket	•			•														•	•				
71/170 Regular-Duty Narrow Adjustable Standard and Bracket System																								
71	Narrow Faced Standard	•			•			•													•			
170 ANO	Bracket	•			•			•													•			
80/180 Regular-Duty Adjustable Standard and Bracket System																								
79/7980	Hang Rail & Standard Link														•	•							•	
80	Standard	•			•		•	•	•	•	•				•	•					•	•		
180	Bracket	•			•		•	•	•	•	•				•	•					•	•		•
181	Lipless Bracket	•			•		•														•			
160LL	Lock Lever Bracket	•			•		•														•			
179	Adjustable Angle Bracket	•			•		•														•			
80-88	Screws/Anchors						•	•	•	•	•				•	•					•	•	•	
82/182 Heavy-Duty Adjustable Standard and Bracket System																								
79/7982	Hang Rail & Standard Link														•	•							•	
82	Standard	•			•		•	•							•	•					•	•		
182	Bracket	•			•		•	•							•	•					•	•		
182BE	Bookend	•			•											•					•			
82DP Screw	Screws/Anchors																•						•	
182DP LCTR/JNR	Shelf Locater/Joiner											•											•	
182DP LOCK	Bracket Lock Tab	•			•			•															•	
83/183 Oversized Heavy-Duty Adjustable Standard and Bracket System																								
83 ANO	Oversized Standard	•			•		•														•			
183	Flange Bracket	•			•		•														•			
161LL	Lock Lever Bracket	•			•		•														•			
85/185 Extra-Duty Adjustable Standard and Bracket System																								
85	Standard	•			•		•								•						•			
185	Bracket	•			•		•								•						•			
106 ANO	Shelf Rest						•														•			
107 ANO	Hang Rod Clamp						•														•			
87/187 Super-Duty Adjustable Standard and Bracket System																								
87	Standard			•	•		•						•		•						•			
186LL	Lock Lever Bracket			•	•		•						•		•						•			
187LL	Lock Lever Bracket			•	•		•						•		•						•			
1987	Steel Shelves												•	•							•			

255™ /256™ Series Mortise-Mount Pilaster Shelving System

- Holds up to 500 lbs. per shelf*
- 1/2" vertical slot adjustment
- Wide selection of finishes and sizes
- Limited lifetime warranty

255 Series Steel Standards

Dimensions: 5/8" width x 3/16" deep x selected length

Material: 23 gauge high strength steel
20 gauge galvanized steel: Economy Zinc (E) products only

Finish: Almond (ALM), Brass-look (BR), Brown (BRN), White (WH), Zinc (ZC), Economy Zinc (E)

Origin: Made in the USA

Features: Numbered slots for fast, accurate clip insertion; countersunk nail and screw holes; full finish coverage to deter corrosion; precision cut lengths; BHMA Grade 1 Compliant*

Pack Configurations



Standard	12"–60", packed 100 standards per carton; 72"–96", packed 50 standards per carton					
Retail (PK)	20 standards per carton					
255 Steel Standards Standard Pack						
Size	Almond (ALM)	Brass-look (BR)	Brown (BRN)	Economy Zinc (E)	White (WH)	Zinc (ZC)
12"	255 ALM 12	255 BR 12	255 BRN 12	255 E 12	255 WH 12	255 ZC 12
18"	255 ALM 18	255 BR 18	255 BRN 18	–	255 WH 18	255 ZC 18
24"	255 ALM 24	255 BR 24	255 BRN 24	255 E 24	255 WH 24	255 ZC 24
30"	255 ALM 30	–	255 BRN 30	–	255 WH 30	255 ZC 30
36"	255 ALM 36	255 BR 36	255 BRN 36	255 E 36	255 WH 36	255 ZC 36
42"	–	–	–	–	–	255 ZC 42
48"	255 ALM 48	255 BR 48	255 BRN 48	255 E 48	255 WH 48	255 ZC 48
60"	255 ALM 60	255 BR 60	255 BRN 60	255 E 60	255 WH 60	255 ZC 60
72"	255 ALM 72	255 BR 72	255 BRN 72	255 E 72	255 WH 72	255 ZC 72
84"	255 ALM 84	255 BR 84	255 BRN 84	255 E 84	255 WH 84	255 ZC 84
96"	255 ALM 96	255 BR 96	255 BRN 96	255 E 96	255 WH 96	255 ZC 96
255 Steel Standards Retail Pack (PK)						
24"	–	PK255 BR 24	–	–	PK255 WH 24	PK255 ZC 24
36"	PK255 ALM 36	PK255 BR 36	PK255 BRN 36	–	PK255 WH 36	PK255 ZC 36
48"	PK255 ALM 48	PK255 BR 48	PK255 BRN 48	–	PK255 WH 48	PK255 ZC 48
60"	PK255 ALM 60	PK255 BR 60	PK255 BRN 60	–	PK255 WH 60	PK255 ZC 60
72"	PK255 ALM 72	PK255 BR 72	PK255 BRN 72	–	PK255 WH 72	PK255 ZC 72



255 Series Aluminum Standards

Dimensions: 5/8" width x 3/16" deep x selected length

Material: 17 gauge aluminum

Finish: Natural (AL), Brass-look (BR), Brown (BRN), Walnut (WAL)

Origin: Made in the USA

Features: Numbered slots for fast, accurate clip insertion; countersunk nail and screw holes; made of rust resistant aluminum; precision cut lengths; BHMA Grade 3 Compliant*

Pack Configurations



Standard	12"–60", packed 100 standards per carton; 72"–96", packed 50 standards per carton					
Retail (PK)	20 standards per carton					
255 Aluminum Standards Standard Pack				255 Standards Retail Pack (PK)		
Size	Natural (AL)	Brass-look (BR)	Brown (BRN)	Walnut (WAL)	Size	Walnut (WAL)
12"	255AL 12	255AL BR 12	255AL BRN 12	255AL WAL 12	36"	PK255AL WAL 36
18"	255AL 18	255AL BR 18	–	255AL WAL 18	48"	PK255AL WAL 48
24"	255AL 24	255AL BR 24	255AL BRN 24	255AL WAL 24	60"	PK255AL WAL 60
30"	255AL 30	255AL BR 30	–	255AL WAL 30	72"	PK255AL WAL 72
36"	255AL 36	255AL BR 36	255AL BRN 36	255AL WAL 36		
42"	255AL 42	–	–	–		
48"	255AL 48	255AL BR 48	255AL BRN 48	255AL WAL 48		
60"	255AL 60	255AL BR 60	255AL BRN 60	255AL WAL 60		
72"	255AL 72	255AL BR 72	255AL BRN 72	255AL WAL 72		
84"	255AL 84	255AL BR 84	255AL BRN 84	255AL WAL 84		
96"	255AL 96	255AL BR 96	255AL BRN 96	255AL WAL 96		



Plated finish products only

☐ Non-stock item – minimum order quantities and additional lead time may apply.

*Standards and brackets meet or exceed ANSI performance standards as established by BHMA testing requirements.

255™ /256™ Series Mortise-Mount Pilaster Shelving System

256 Series Pilaster Shelf Support

Material: High-strength steel, Aluminum (AL)
Finish: Almond (ALM), Brass-look (BR), Walnut (WAL), White (WH), Zinc (ZC), Natural Aluminum (AL NAT)
Origin: Made in the USA
Features: Patented design; full coverage finish to resist corrosion; strength increasing dimple



Pack Configurations

Standard Pack	100 pieces per carton			
Bulk (B)	1000 pieces per carton			
Barrel (BBL)	9000 pieces per barrel			
Poly (P)	12 supports and 28 nails per bag; 10 bags per carton			
Warehouse (WP)	12 supports and 28 nails per bag; 50 bags per carton			
256 Shelf Supports Almond (ALM) Finish				
Standard	Bulk (B)	Barrel (BBL)	Poly (P)	Warehouse (WP)
256S ALM	-	-	256S P ALM	-
256 Shelf Supports Brass-look (BR) Finish				
256 BR	256B BR	256BBL BR	256P BR	-
256 Shelf Supports Walnut (WAL) Finish				
256 WAL	256B WAL	256BBL WAL	256P WAL	-
256 Shelf Supports White (WH) Finish				
256S WH	-	-	256S P WH	256S WP WH
256 Shelf Supports Zinc (ZC) Finish				
256 ZC	256B ZC	256BBL ZC	256P ZC	256WP ZC
256 Shelf Supports Natural Aluminum (AL NAT) Finish				
256 AL NAT	-	-	-	-

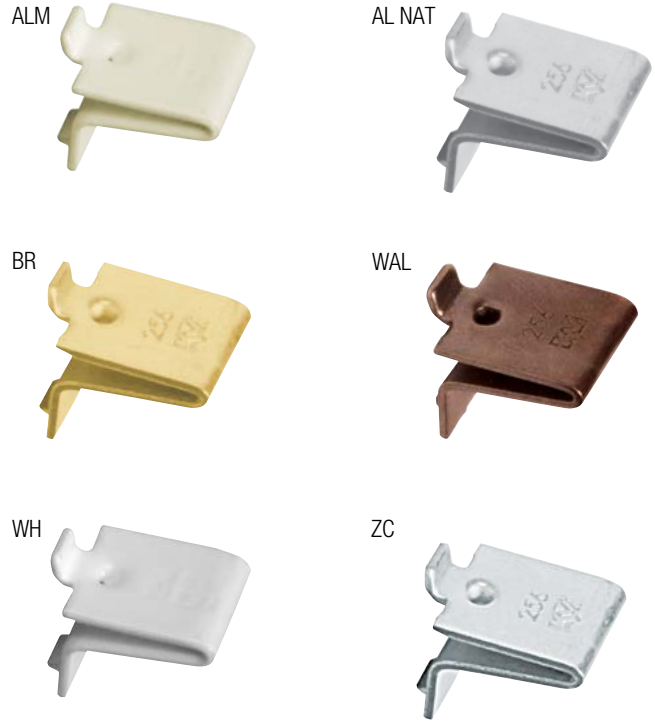

NOTE: Use 256 WAL with 255 BRN and 255AL WAL

Specialty Pilaster Shelf Supports

Part #: **256R ZC:** Support with Rubber Cushion
239 ZC*: Shelf Support
24276 ZC: Shelf Support with Mounting Hole
243 ZC: 3" Shelf Bracket (non-handed)
244 ANO: Wire Shelf Support
757 ANO: Flange for 1-1/16" OD closet rod

Material: High-strength steel, cold rolled steel
Finish: Anochrome (ANO), Zinc (ZC)
Origin: Made in the USA
Packed: 100 per carton



229 Series Support Bracket

Finish: Anochrome (ANO)
Packed: 25 per carton

229 Bracket	
Size	Anochrome (ANO)
4"	229 ANO 4
6"	229 ANO 6
8"	229 ANO 8
10"	229 ANO 10



* WoodWork Institute Acknowledged Products

Download at www.kv.com > Resource Library

233™ /237™ Series Surface-Mount Pilaster Shelving System

- Holds up to 500 lbs. per shelf*
- 1/2" vertical slot adjustability
- BHMA Grade 1 Compliant*
- Limited lifetime warranty

233 Surface Mount Steel Pilaster Standards

Dimensions: 13/16" width x 3/16" deep x selected height

Material: 23 gauge high-strength steel

Finish: Brass-look (BR), Steel (STL), Zinc (ZC)

Origin: Made in the USA

Features: Numbered slots for quick, accurate clip insertion; countersunk nail, screw and staple holes; full finish coverage to deter corrosion; precision cut lengths



Pack Configurations

Standard	12"–60" packed 100 standards per carton; 72"–96" packed 50 standards per carton				
Retail (P)	20 standards per carton				
233 Series Steel Standards Standard Pack			233 Series Steel Standards Retail Pack (PK)		
Size	Brass-look (BR)	Steel (STL)	Zinc (ZC)	Size	Zinc (ZC)
12"	233 BR 12	233 STL 12	233 ZC 12	48"	PK233 ZC 48
18"	–	–	233 ZC 18	72"	PK233 ZC 72
24"	–	233 STL 24	233 ZC 24		
30"	–	–	233 ZC 30		
36"	233 BR 36	233 STL 36	233 ZC 36		
42"	–	–	233 ZC 42		
48"	233 BR 48	233 STL 48	233 ZC 48		
60"	233 BR 60	233 STL 60	233 ZC 60		
72"	233 BR 72	233 STL 72	233 ZC 72		
84"	–	–	233 ZC 84		
96"	233 BR 96	233 STL 96	233 ZC 96		

Pilaster Shelf Supports

- Part #:** **237 ZC:** Shelf support for 233 pilaster
238 ANO: Shelf support with locator tab
242 ANO: Wire shelf support

Finish: Anochrome (ANO), Zinc (ZC)

Featured: Made in the USA

Packed: 100 pieces per carton

Features: Full finish coverage to deter corrosion



Nails for 255 and 233 Series Standards

Pack Configurations

Standard	Approximately 650 nails per bag; 5 bags per carton	
255 and 233 Nails		
Part	Finish	Use with:
255-81N ALM	Almond (ALM)	255 ALM
255-81N BR	Brass-look (BR)	255 BR, 233 BR, 255AL BR
255-81N STB	Bronzed (STB)	255 BRN, 255 AL BRN, 255AL WAL
255-81N WH	White (WH)	255 WH
255-81N ZC	Zinc (ZC)	255 ZC, 233 ZC, 255E, 255AL



☐ Non-stock item – minimum order quantities and additional lead time may apply.

*Standards and brackets meet or exceed ANSI performance standards as established by BHMA testing requirements.

70™ / 71™ / 170™ Regular-Duty Standard and Bracket System

- Single slot system
- 1" vertical slot adjustment

- BHMA Grade 2 Compliant*
- Limited lifetime warranty

70 Series Standards

Dimensions: 5/8" wide x 13/32" deep x selected height
Material: 16 gauge galvanized steel
Finish: Economy Zinc (E)
Origin: Made in the USA
Features: Safety lead-in at top of standard; countersunk screw holes; embossed "up" and arrow to show correct orientation; center aligned slots and screw holes; precision cut lengths

Pack Configurations

Retail (P)	10 per carton, screws not included, UPC label applied
70 Series Standards	
Size	Economy Zinc (E)
24"	P70 E 24
36"	P70 E 36
48"	P70 E 48
72"	P70 E 72



170E Series Brackets

Material: 16 gauge galvanized steel
Finish: Economy Zinc (E)
Origin: Made in the USA
Features: Holds up to 200 lbs. per pair; two locking teeth; shelf retaining lip; embossed "s" stabilizer

Pack Configurations

Standard	50 per carton, no UPC	
Retail (P)	20 per carton, UPC label applied	
170E Series Brackets		
Size	Standard	Poly (P)
8"	170E 8	P170 E 8
10"	170E 10	P170 E 10
12"	170E 12	P170 E 12



71 Series Narrow Standards

Dimensions: 5/16" wide x 13/32" deep x selected height
Material: 13 gauge steel
Finish: Anochrome (ANO)
Origin: Made in the USA
Features: Narrow design to fit between prefabricated wall panels for flush wall mount; countersunk screw holes; center aligned slots and screw holes; precision cut lengths

Pack Configurations

Standard	10 per carton
71 Series Standards	
Size	Anochrome (ANO)
48"	71 ANO 48
60"	71 ANO 60
72"	71 ANO 72
96"	71 ANO 96



170 ANO Series Brackets

Material: 14 gauge steel
Finish: Anochrome (ANO)
Origin: Made in the USA
Features: Holds up to 210 lbs. per pair; two locking teeth; shelf retaining lip; stamped wing stabilizer

Pack Configurations

Standard	10 per carton	
170 ANO Series Brackets		
Size	Anochrome (ANO)	
10"	170 ANO 10	
12"	170 ANO 12	
14"	170 ANO 14	



■ Non-stock item – minimum order quantities and additional lead time may apply.

*Standards and brackets meet or exceed ANSI performance standards as established by BHMA testing requirements.

80™ / 180™ Regular-Duty Standard and Bracket System

- Single slot design
- 1" vertical slot adjustability

- BHMA Grade 2 Compliant*
- Limited lifetime warranty

80 Series Standards

Dimensions: 5/8" wide x 13/32" deep x selected length

Material: 16 gauge steel

Finish: Almond (ALM), Anochrome (ANO), Black (BLK), Brass-look (BR), Brown (BN), Titanium (TI), White (WH)

Origin: Made in the USA

Features: Countersunk screw holes; safety lead-in at top of standards; embossed "up" and arrow to show correct orientation; center aligned slots and screw holes; precision cut lengths

Pack Configurations



Standard	10 standards per carton, with UPC labels						
Builders Pack (BP)	25 standards per carton, no UPC labels						
80 Series Standards Standard Pack							
Size	Almond (ALM)	Anochrome (ANO)	Black (BLK)	Brown (BN)	Brass-look (BR)	Titanium (TI)	White (WH)
12"	80 ALM 12	80 ANO 12	80 BLK 12	80 BN 12	80 BR 12	80 TI 12	80 WH 12
18"	–	80 ANO 18	–	–	–	–	–
24"	80 ALM 24	80 ANO 24	80 BLK 24	80 BN 24	80 BR 24	80 TI 24	80 WH 24
36"	80 ALM 36	80 ANO 36	80 BLK 36	80 BN 36	80 BR 36	80 TI 36	80 WH 36
48"	80 ALM 48	80 ANO 48	80 BLK 48	80 BN 48	80 BR 48	80 TI 48	80 WH 48
60"	80 ALM 60	80 ANO 60	80 BLK 60	80 BN 60	80 BR 60	80 TI 60	80 WH 60
72"	80 ALM 72	80 ANO 72	80 BLK 72	80 BN 72	80 BR 72	80 TI 72	80 WH 72
84"	–	80 ANO 84	–	–	–	–	–
96"	–	80 ANO 96	80 BLK 96	–	–	–	80 WH 96

80 Series Standards Builder Pack (BP)	
Size	Anochrome (ANO)
24"	80BP ANO 24
36"	80BP ANO 36
48"	80BP ANO 48
60"	80BP ANO 60
72"	80BP ANO 72
84"	80BP ANO 84
96"	80BP ANO 96



☐ Non-stock item – minimum order quantities and additional lead time may apply.

*Standards and brackets meet or exceed ANSI performance standards as established by BHMA testing requirements.

80™ / 180™ Regular-Duty Standard and Bracket System

180 Series Brackets

- Material:** 14 and 16 gauge steel
Finish: Almond (ALM), Anochrome (ANO), Black (BLK), Brass-look (BR), Brown (BN), Titanium (TI), White (WH)
Origin: Made in the USA
Features: Holds up to 320 lbs. per pair*; two complete locking teeth; spring steel clip for stability and friction lock; shelf retaining lip

Pack Configurations



Standard	10 brackets per carton with UPC labels attached
Hefty Pack (HP)	40 brackets per display carton, with UPC labels
Builders Pack (BP)	100 brackets per carton, no UPC labels

180 Series Brackets Standard Pack							
Size	Almond (ALM)	Anochrome (ANO)	Black (BLK)	Brown (BN)	Brass-look (BR)	Titanium (TI)	White (WH)
4"	–	180 ANO 4	180 BLK 4	–	–	–	180 WH 4
6"	180 ALM 6	180 ANO 6	180 BLK 6	180 BN 6	180 BR 6	180 TI 6	180 WH 6
8"	180 ALM 8	180 ANO 8	180 BLK 8	180 BN 8	180 BR 8	180 TI 8	180 WH 8
10"	180 ALM 10	180 ANO 10	180 BLK 10	180 BN 10	180 BR 10	180 TI 10	180 WH 10
12"	180 ALM 12	180 ANO 12	180 BLK 12	180 BN 12	180 BR 12	180 TI 12	180 WH 12
14"	180 ALM 14	180 ANO 14	180 BLK 14	–	180 BR 14	–	180 WH 14
16"	180 ALM 16	180 ANO 16	180 BLK 16	180 BN 16	180 BR 16	180 TI 16	180 WH 16
18"	–	180 ANO 18	–	–	–	–	180 WH 18
20"	–	180 ANO 20	–	–	–	–	180 WH 20

180 Series Brackets Hefty Pack (HP)							
6"	–	–	–	–	–	180HP TI 6	180HP WH 6
8"	–	180HP ANO 8	180HP BLK 8	–	–	180HP TI 8	180HP WH 8
10"	–	180HP ANO 10	180HP BLK 10	–	–	180HP TI 10	180HP WH 10
12"	–	180HP ANO 12	180HP BLK 12	–	–	180HP TI 12	180HP WH 12
16"	–	180HP ANO 16	180HP BLK 16	–	–	180HP TI 16	180HP WH 16

180 Series Brackets Builders Pack (BP)		
6"	–	180BP ANO 6
8"	–	180BP ANO 8
10"	–	180BP ANO 10
12"	–	180BP ANO 12
14"	–	180BP ANO 14
16"	–	180BP ANO 16
18"	–	180BP ANO 18

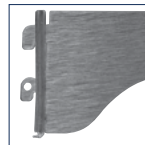

Locking Teeth Side View



Screws and Anchors

- Dimensions:** #6 head, #8 body, 1-1/2" length
Finish: Almond (ALM), Anochrome (ANO), Black (BLK), Brown (BN), Brass-look (BR), Titanium (TI), White (WH), Zinc (ZC)
Features: For proper installation of 80 series standards

Pack Configurations

Display Pack (DP)	20 poly bags per carton; each poly bag contains 6 screws and 6 screw anchors
Standard Pack	50 screws per pack, no anchors
Bulk Pack	1,000 bulk screws per poly; 6,000 per carton

80 Series Screw Packs								
Pack Type	Almond (ALM)	Anochrome (ANO)	Black (BLK)	Brown (BN)	Brass-look (BR)	Titanium (TI)	White (WH)	Zinc (ZC)
Display Pack	80-88DP ALM	80-88DP ANO	80-88DP BLK	80-88DP BN	80-88DP BR	80-88DP TI	80-88DP WH	–
Standard Pack	80-80 ALM	–	80-80 BLK	–	80-80 BR	–	80-80 WH	80-80 ZC
Bulk Pack	200239-4 ALM	–	200230-7 BLK	–	200231-0 BR	200241-1	200235-2 WH	200234-9 ZC

□ Non-stock item – minimum order quantities and additional lead time may apply.

*Standards and brackets meet or exceed ANSI performance standards as established by BHMA testing requirements.

80™/180™ Series Regular-Duty Standard and Bracket System

160LL™ Series Lock Lever Bracket

Material: 14 gauge steel
Finish: Anochrome (ANO), Brass-look (BR)
Origin: Made in the USA
Features: For use with 1" adjustable standards; two locking teeth; lever lock for extra secure mounting and stability; shelf retaining lip

Pack Configurations

Standard	10 per carton, no UPC labels	
160 Series Brackets		
Size	Anochrome (ANO)	Brass-look (BR)
6"	160LL ANO 6	–
8"	160LL ANO 8	160LL BR 8
10"	160LL ANO 10	160LL BR 10
12"	160LL ANO 12	160LL BR 12
14"	160LL ANO 14	–
16"	160LL ANO 16	–
18"	160LL ANO 18	–



179™ Series Adjustable Angle Brackets

Material: 14 and 16 gauge steel
Finish: Anochrome (ANO)
Origin: Made in the USA
Features: For use with 1" adjustment standards; two complete locking teeth; shelf retaining lip; spring clip for stability and friction locking; adjust to 15°, 30°, 45° and level

Pack Configurations

Standard	10 per carton, no UPC labels	
179 Series Brackets		
Size	Anochrome (ANO)	
10"	179 ANO 10	
12"	179 ANO 12	
14"	179 ANO 14	



181™ Series Lipless Brackets

Material: 14 and 16 gauge steel
Finish: Anochrome (ANO)
Origin: Made in the USA
Features: For use with 1" adjustment standards; two complete locking teeth; spring clip provides stability and a friction lock; lipless version of the 180 series bracket to allow for easy concealing of the bracket

Pack Configurations

Standard	10 per carton, no UPC labels	
181 Series Brackets		
Size	Anochrome (ANO)	
8"	181 ANO 8	
10"	181 ANO 10	
12"	181 ANO 12	
14"	181 ANO 14	
16"	181 ANO 16	

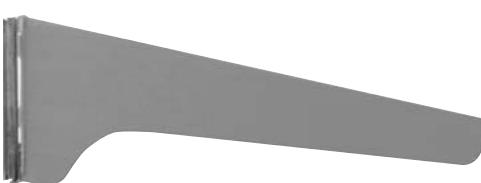

☐ Non-stock item – minimum order quantities and additional lead time may apply.

Customer Service: 1.800.253.1561

80™ / 180™ Series Regular-Duty Standard and Bracket System

79 Series Easy Installation Hang Rail

Dimensions: 2" tall x 1/2" deep

Material: Hardened steel

Finish: Titanium (TI), White (WH)

Features: Holds up to 2,700 lbs. per 80" hang rail, and up to 1,700 lbs. per 48" hang rail; rail has screw holes every 8" for mounting to 16" and 24" stud centers; rigid profile design prevents twisting and bowing; mounts to most wall types and bare studs; anti-dislodge safety features

7980 Standard Links

Dimensions: 6-5/8" tall x 3/4" wide x 4/5" deep

Material: Cast aluminum

Finish: Titanium (TI), White (WH)

Features: Holds up to 200 lbs. per standard link; sleek design for a clean look; mounting screws included

Pack Configurations

Standard	10 per carton	
79 Series Easy Installation Hang Rail		
Size	Titanium (TI)	White (WH)
48"	79 TI 48	79 WH 48
80"	79 TI 80	79 WH 80

Pack Configurations

Standard	12 pairs per carton, with screws	
7980 Series Standard Links		
Titanium (TI)	White (WH)	
7980 TI	7980 WH	

WH



TI



TI



WH



Accessories

Packed: 100 per carton

- 101 PLAS: Clear plastic back rest with divider
- 102 PLAS: Clear plastic front rest with divider
- 103 PLAS: Clear plastic front rest
- 103-1/2L PLAS: Clear plastic front rest left
- 103-1/2R PLAS: Clear plastic front rest right
- 104 ANO: Anochrome (ANO) steel back rest
- 104 PLAS: Clear plastic back rest
- 104-1/2 PLAS: Clear plastic back rest
- 119 RUB: Gray rubber cushion use with metal rests
- 129 RUB: Gray rubber cushion use with plastic rests
- 136 ANO: Socket-#80 standard bottom socket
- 137 ANO: Socket-#80 standard top socket
- 153 ANO: Standard fastener floor mount (bolt and nut not included)
- 154 ANO: Shelf-fastener (fastens shelf to bracket)



82™ /182™ Series Heavy-Duty Standard and Bracket System

- Double slot design
- 1-1/4" vertical slot adjustability
- BHMA Grade 2 Compliant*
- Limited lifetime warranty

82 Series Standards

Dimensions: 1-1/16" wide x 11/16" deep x selected length
Material: 14 gauge steel
Finish: Almond (ALM), Black (BLK), Titanium (TI), White (WH)

Origin: Made in the USA
Features: Strength enhancing ribs; countersunk screw holes; embossed "up" and arrow to show correct orientation; center aligned slots and screw holes; precision cut lengths

Pack Configurations



Standard	10 standards per carton with UPC labels			
Builders Pack (BP)	10 standards per carton, no UPC labels			
82 Series Standards Standard Pack				
Size	Almond (ALM)	Black (BLK)	Titanium (TI)	White (WH)
16.5"	82 ALM 16.5	82 BLK 16.5	82 TI 16.5	82 WH 16.5
28"	82 ALM 28	82 BLK 28	82 TI 28	82 WH 28
39"	82 ALM 39	82 BLK 39	82 TI 39	82 WH 39
48"	82 ALM 48	82 BLK 48	82 TI 48	82 WH 48
63"	82 ALM 63	82 BLK 63	82 TI 63	82 WH 63
78"	82 ALM 78	82 BLK 78	82 TI 78	82 WH 78
94"	82 ALM 94	82 BLK 94	82 TI 94	82 WH 94
82 Series Standards Builders Pack (BP)				
16.5"	82BP ALM 16.5	82BP BLK 16.5	–	82BP WH 16.5
28"	82BP ALM 28	82BP BLK 28	–	82BP WH 28
39"	82BP ALM 39	82BP BLK 39	–	82BP WH 39
48"	82BP ALM 48	82BP BLK 48	–	82BP WH 48
63"	82BP ALM 63	82BP BLK 63	–	82BP WH 63
78"	82BP ALM 78	82BP BLK 78	–	82BP WH 78
94"	82BP ALM 94	82BP BLK 94	–	82BP WH 94

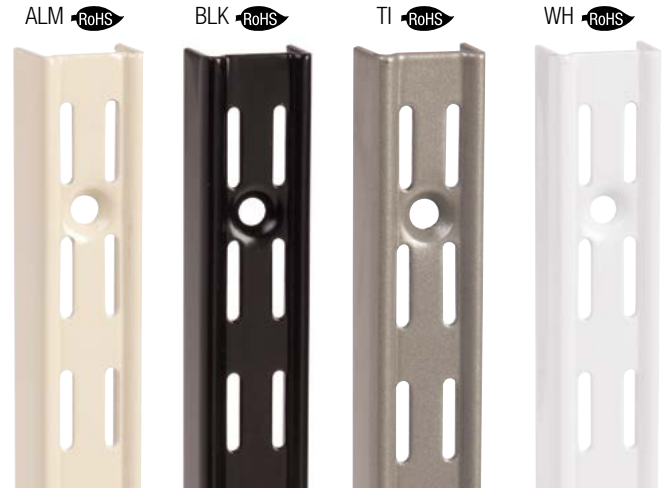

Accessories

182BE Bookend

Finish: White (WH)
Packed: 10 pairs per carton
Origin: Made in the USA

82 Series Bookend Standard Pack	
Size	White (WH)
7"	182BE WH 7
9"	182BE WH 9
10.5"	182BE WH 10.5

82DP SCREW ZC

Finish: Zinc (ZC)
Packed: 20 bags per carton (6 screws + 6 anchors per bag)

182DP LCTR/JNR Shelf Locator Joiner

Finish: Clear plastic (CL)
Packed: 20 bags per carton (4 joiners + 8 screws per bag)

182DP LOCK Bracket Lock

Finish: Black rubber (BLK)
Packed: 20 bags per carton (6 locks per bag)

182BE



82DP SCREW ZC



182DP LCTR/JNR



182DP LOCK



☐ Non-stock item – minimum order quantities and additional lead time may apply.

*Standards and brackets meet or exceed ANSI performance standards as established by BHMA testing requirements.

82™ /182™ Series Heavy-Duty Standard and Bracket System

182 Series Brackets

- Material:** 16 gauge steel
Finish: Almond (ALM), Black (BLK), Titanium (TI), White (WH)
Features: Holds up to 450 lbs. per pair of brackets*; four complete locking teeth; countersunk screw holes to fasten shelves

Pack Configurations



Standard	10 brackets per carton with UPC labels			
Builders Pack (BP)	10 brackets per carton, no UPC labels			
182 Series Brackets Standard Pack				
Size	Almond (ALM)	Black (BLK)	Titanium (TI)	White (WH)
5"	–	–	–	182 WH 5
7"	182 ALM 7	182 BLK 7	182 TI 7	182 WH 7
9"	182 ALM 9	182 BLK 9	182 TI 9	182 WH 9
10.5"	182 ALM 10.5	182 BLK 10.5	182 TI 10.5	182 WH 10.5
12.5"	182 ALM 12.5	182 BLK 12.5	182 TI 12.5	182 WH 12.5
14.5"	182 ALM 14.5	182 BLK 14.5	182 TI 14.5	182 WH 14.5
18.5"	182 ALM 18.5	182 BLK 18.5	182 TI 18.5	182 WH 18.5
24"	182 ALM 24	182 BLK 24	182 TI 24	182 WH 24
182 Series Brackets Builders Pack (BP)				
5"	–	182BP BLK 5	–	182BP WH 5
7"	182BP ALM 7	182BP BLK 7	–	182BP WH 7
9"	182BP ALM 9	182BP BLK 9	182BP TI 9	182BP WH 9
10.5"	182BP ALM 10.5	182BP BLK 10.5	182BP TI 10.5	182BP WH 10.5
12.5"	182BP ALM 12.5	182BP BLK 12.5	182BP TI 12.5	182BP WH 12.5
14.5"	182BP ALM 14.5	182BP BLK 14.5	182BP TI 14.5	182BP WH 14.5
18.5"	182BP ALM 18.5	182BP BLK 18.5	182BP TI 18.5	182BP WH 18.5
24"	182BP ALM 24	182BP BLK 24	182BP TI 24	182BP WH 24

ALM



BLK



TI



WH



79 Easy Installation Hang Rail

- Dimensions:** 2" tall x 1/2" deep x selected length
Material: Hardened steel
Finish: Titanium (TI), White (WH)
Features: Holds up to 2,700 lbs. per 80" hang rail; and 1,700 lbs. per 48" hang rail; hang rail has screw holes every 8" for mounting to 16" and 24" stud centers; hang rail has a rigid profile design that prevents twisting and bowing; mounts to most wall types and bare studs; anti-dislodge safety features

WH



TI



Pack Configurations

Standard	10 per carton	
Size	Titanium (TI)	White (WH)
48"	79 TI 48	79 WH 48
80"	79 TI 80	79 WH 80

7982 Standard Links

- Dimensions:** 4-7/8" tall x 1-1/4" wide x 3/4" deep
Material: Cast aluminum
Finish: Titanium (TI), White (WH)
Features: Holds up to 450 lbs. per standard link; sleek design for a clean look; mounting screws included

TI



WH



Pack Configurations

Standard	12 pairs per carton	
Titanium (TI)	White (WH)	
7982 TI	7982 WH	

*Standards and brackets meet or exceed ANSI performance standards as established by BHMA testing requirements.

83™ / 183™ Series Heavy-Duty Standard and Bracket System

- Single slot design
- 1" vertical slot adjustability

- BHMA Grade 2 Compliant*
- Limited lifetime warranty

83 Series Oversized Standards

Dimensions: 3/4" wide x 1/2" deep x selected length

Material: 16 gauge steel

Finish: Anochrome (ANO)

Origin: Made in the USA

Features: Safety lead-in at top of standard; embossed logo to show correct orientation; countersunk screw holes; center aligned slots and screw holes; precision cut lengths

Pack Configurations

Standard	10 standards per carton, no UPC labels
83 Series Standards Standard Pack	
Size	Anochrome (ANO)
24"	83 ANO 24
36"	83 ANO 36
48"	83 ANO 48
60"	83 ANO 60
72"	83 ANO 72
84"	83 ANO 84
96"	83 ANO 96



Accessories

113L ANO Left-Hand Anochrome (ANO) Panel Clip

113R ANO Right-Hand Anochrome (ANO) Panel Clip

Finish: Anochrome (ANO)

Origin: Made in the USA

Packed: 50 per carton; Left and right clips packed separately

Application: Used to attach display and wall panels into vertical position



119 RUB Gray rubber cushion for use with 183 series brackets

Packed: 100 per carton



134 ANO Socket-#83 Standard Bottom Socket

135 ANO Socket-#83 Standard Top Socket

Origin: Made in the USA

Packed: 100 per carton



159LL ANO Lock Lever Heavy-Duty Support Bracket

Finish: Anochrome (ANO)

Origin: Made in the USA

Packed: 100 per carton

Benefit: Provides extra support for shelves with heavy loads; lever lock for extra secure mounting and stability



191 ANO Hang Rod Saddle

192 ANO Hang Rod Saddle

Finish: Anochrome (ANO)

Origin: Made in the USA

Packed: 10 per carton

Features: 191 bolts to 183L & 183R or 185 brackets to hold 1-1/16" O.D. tubing

192 bolts to 183L & 183R or 185 brackets to hold 1-5/16" O.D. tubing



*Standards and brackets meet or exceed ANSI performance standards as established by BHMA testing requirements.

83™ /183™ Series Heavy-Duty Standard and Bracket System

183 Series Brackets

Part #: 183R: Right Flange Bracket
 183L: Left Flange Bracket
 183C: Center Flange Bracket

Material: 16 gauge steel
Finish: Anochrome (ANO)
Origin: Made in the USA

Features: Holds up to 460 lbs. per pair of brackets*; bracket flanges allow for simple attachment to wooden shelves; brackets may also be used with 85 Series Standards for added support on long shelves

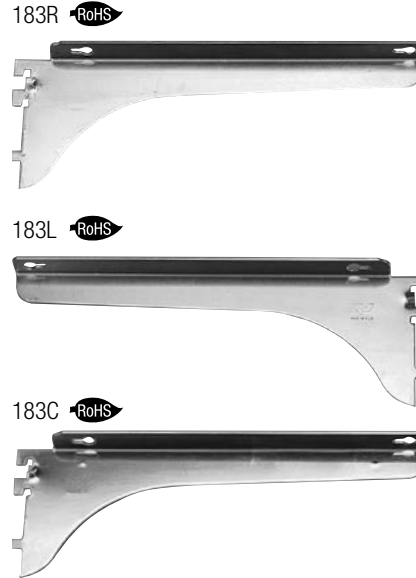

Pack Configurations

Standard	10 brackets per carton, no UPC labels		
183 Series Brackets Standard Pack - Anochrome (ANO) Finish			
Size	Right	Left	Center
8"	183R ANO 8	183L ANO 8	183C ANO 8
10"	183R ANO 10	183L ANO 10	183C ANO 10
12"	183R ANO 12	183L ANO 12	183C ANO 12
14"	183R ANO 14	183L ANO 14	183C ANO 14
16"	183R ANO 16	183L ANO 16	183C ANO 16
18"	183R ANO 18	183L ANO 18	183C ANO 18
20"	183R ANO 20	183L ANO 20	183C ANO 20

161LL Lock Lever Bracket

Material: 14 gauge steel
Finish: Anochrome (ANO)
Origin: Made in the USA
Features: Three locking teeth; lever lock for extra secure mounting and stability; for use with 1" adjustable shelving; shelf retaining lip



Pack Configurations

Standard	10 brackets per carton, no UPC labels
161LL Brackets	
Size	Anochrome
14"	161LL ANO 14
16"	161LL ANO 16
18"	161LL ANO 18
20"	161LL ANO 20
24"	161LL ANO 24

*Standards and brackets meet or exceed ANSI performance standards as established by BHMA testing requirements.

85™ / 185™ Series Extra-Duty Standard and Bracket System

- Single slot design
- 1" vertical slot adjustability
- BHMA Grade 2 Compliant*
- Limited lifetime warranty

85 Series Standards

Dimensions: 1-1/4" wide x 1/2" deep x selected length

Material: 16 gauge steel

Finish: Anochrome (ANO), White (WH)

Origin: Made in the USA

Features: Safety lead-in at top of standard; embossed logo to show correct orientation; countersunk screw holes; center aligned slots and screw holes; precision cut lengths

Pack Configurations



Standard	10 brackets per carton, no UPC labels			
Retail Pack (B)	10 brackets per carton with UPC labels			
85 Series Standards Standard Pack			85 Series Standards Retail Pack	
Size	Anochrome (ANO)	White (WH)	Size	Anochrome (ANO)
24"	85 ANO 24	85 WH 24	24"	–
36"	85 ANO 36	85 WH 36	36"	–
48"	85 ANO 48	85 WH 48	48"	85B ANO 48
60"	85 ANO 60	85 WH 60	60"	–
72"	85 ANO 72	85 WH 72	72"	85B ANO 72
84"	85 ANO 84	85 WH 84	84"	–
96"	85 ANO 96	85 WH 96	96"	–

ANO



WH



Accessories

106 ANO: Shelf Rest

Finish: Anochrome (ANO)

Packed: 100 per carton

Origin: Made in the USA

Application: Used to join two shelves at one bracket

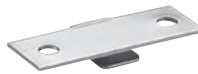

107 ANO: Hang Rod Clamp

Finish: Anochrome (ANO)

Packed: 20 per carton

Origin: Made in the USA

Application: Bolts to 183 and 185 Brackets to hold rods securely



113L ANO: Left-Hand Anochrome (ANO) Panel Clip

113R ANO: Right-Hand Anochrome (ANO) Panel Clip

Finish: Anochrome (ANO)

Packed: 50 per carton; Left and right clips packed separately

Origin: Made in the USA

Application: Used to attach display and wall panels into vertical position



129 RUB: Gray rubber cushion for use with metal and plastic rests

Packed: 100 per carton



159LL ANO: Lock Lever Heavy-Duty Support Bracket

Finish: Anochrome (ANO)

Packed: 100 per carton

Origin: Made in the USA

Benefit: Provides extra support for shelves with heavy loads; lock lever for extra secure mounting and stability



191 ANO: Hang Rod Saddle

192 ANO: Hang Rod Saddle

Finish: Anochrome (ANO)

Packed: 10 per carton

Origin: Made in the USA

Features: 191 bolts to 183L & 183R or 185 brackets to hold 1-1/16" O.D. tubing
192 bolts to 183L & 183R or 185 brackets to hold 1-5/16" O.D. tubing



*Standards and brackets meet or exceed ANSI performance standards as established by BHMA testing requirements.

85™ /185™ Series Extra-Duty Standard and Bracket System

185 Series Brackets

Material: 14 and 16 gauge steel

Finish: Anochrome (ANO), White (WH)

Origin: Made in the USA

Features: Holds up to 680 lbs. per pair of brackets*; shelf retaining lip on brackets; four locking teeth and two lugs for safety and stability; shelf fastening screw holes

Pack Configurations



Standard	10 brackets per carton, no UPC labels	
Retail Pack (B)	10 brackets per carton with UPC labels	
185 Series Brackets Standard Pack		
Size	Anochrome (ANO)	White (WH)
8"	185 ANO 8	185 WH 8
10"	185 ANO 10	185 WH 10
12"	185 ANO 12	185 WH 12
14"	185 ANO 14	185 WH 14
16"	185 ANO 16	185 WH 16
18"	185 ANO 18	185 WH 18
20"	185 ANO 20	185 WH 20
22"	185 ANO 22	185 WH 22
24"	185 ANO 24	185 WH 24
185 Series Brackets Retail Pack (B)		
10"	185B ANO 10	
12"	185B ANO 12	
14"	–	
16"	185B ANO 16	
18"	–	
20"	–	
22"	–	
24"	185B ANO 24	

ANO



WH



NOTE: 180 Anochrome (ANO) brackets and all other KV 1" adjustable brackets can be used with 85 Series double-slotted standards.

*Standards and brackets meet or exceed ANSI performance standards as established by BHMA testing requirements.

87™ /186™ /187™ Series Super-Duty Standard and Bracket System

- Single slot design
- 2" vertical slot adjustability
- Limited lifetime warranty
- BHMA Grade 2 Compliant*

87 Series Standards

Dimensions: 7/8" wide x 11/16" deep x selected height

Material: 12 gauge steel

Finish: Anochrome (ANO), White (WH)

Origin: Made in the USA

Features: Countersunk screw holes; embossed logo to show correct orientation; center aligned slots and screw holes; precision cut lengths

Pack Configurations



Standard	5 per carton, no UPC labels	
87 Series Standards Standard Pack		
Size	Anochrome (ANO)	White (WH)
24"	87 ANO 24	87 WH 24
36"	87 ANO 36	87 WH 36
48"	87 ANO 48	87 WH 48
60"	87 ANO 60	87 WH 60
72"	87 ANO 72	87 WH 72
84"	87 ANO 84	87 WH 84
96"	87 ANO 96	87 WH 96



1987 Series Galvanized Steel Shelving

Material: Galvanized steel

Finish: Galvanized Steel (GALV)

Origin: Made in the USA

Features: Predrilled mounting holes to fasten to brackets



Pack Configurations

Standard	5 per carton; except 20" x 32": 3 per carton
1987 Series Shelving Standard Pack	
Size	Galvanized (GALV)
8" x 32"	1987 GALV 8X32
10" x 32"	1987 GALV 10X32
12" x 32"	1987 GALV 12X32
16" x 32"	1987 GALV 16X32
20" x 32"	1987 GALV 20X32

*Standards and brackets meet or exceed ANSI performance standards as established by BHMA testing requirements.

87™ /186™ /187™ Series Super-Duty Standard and Bracket System

186LL and 187LL Series Lock Lever Brackets

Material: 12 gauge steel
Finish: Anochrome (ANO), White (WH)
Origin: Made in the USA
Features: Holds up to 1,060 lbs. per pair of brackets*; utilizes an easy-to-install unique cam lock that secures brackets to the standard; two or three complete locking teeth; predrilled holes for mounting 1987 Series shelves or attaching shelf rests



Pack Configurations

Standard	10 per carton, no UPC labels	
186 Series Brackets Standard Pack		
Size	Anochrome (ANO)	White (WH)
8"	186LL ANO 8	186LL WH 8
10"	186LL ANO 10	186LL WH 10
187 Series Brackets Standard Pack		
12"	187LL ANO 12	187LL WH 12
14"	187LL ANO 14	187LL WH 14
16"	187LL ANO 16	187LL WH 16
18"	187LL ANO 18	187LL WH 18
20"	187LL ANO 20	187LL WH 20
22"	187LL ANO 22	187LL WH 22
24"	187LL ANO 24	187LL WH 24

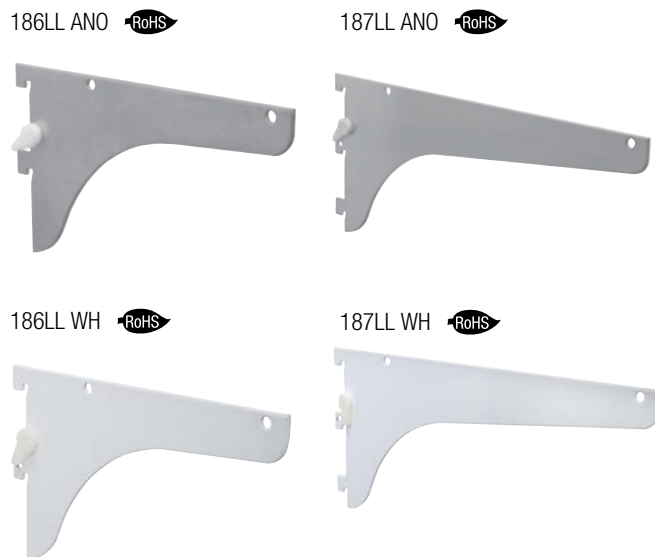

Accessories

87-10 WH 100

Sizes: #10 x 2-3/4" screw
Finish: White (WH)
Packed: 100 per bag



119 RUB: Gray rubber cushion for use with metal rests

Packed: 100 per carton

Recommended for use when supporting glass shelves



129 RUB: Gray rubber cushion for use with metal and plastic rests

Packed: 100 per carton

Recommended for use when supporting glass shelves



210 ANO: Anochrome (ANO) End Rest with screw
210 WH: White (WH) End Rest with screw
211 ANO: Anochrome (ANO) Center Rest with screw
211 WH: White (WH) Center Rest with screw
212 ANO: Anochrome (ANO) Front Rest with screw
212 WH: White (WH) Front Rest with screw
213C ZC: Zinc (ZC) Snap-In Center Rest
Finish: Anochrome (ANO), White (WH), Zinc (ZC)
Packed: 100 per carton

Recommended for use with 186 and 187 Series Brackets for anchoring shelf to brackets to shelves

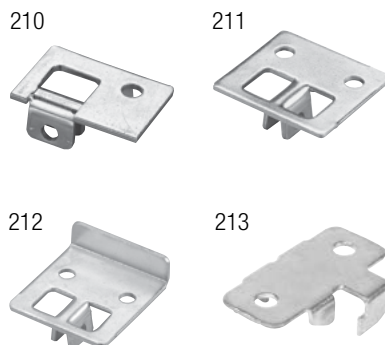

*Standards and brackets meet or exceed ANSI performance standards as established by BHMA testing requirements.

87™ /186™ /187™ Super-Duty Stainless Steel Standard and Bracket System

- Single slot design
- 2" vertical slot adjustability
- Limited lifetime warranty
- BHMA Grade 2 Compliant*

87 Series Standards

Dimensions: 7/8" wide x 11/16" deep
Material: 14 gauge, 304 grade stainless steel
Finish: Stainless Steel (SS)

Origin: Made in the USA
Features: Countersunk screw holes; center aligned slots and screw holes; precision cut lengths

Pack Configurations



Standard	5 per carton, no UPC labels
87 Series Standards Standard Pack	
Size	Stainless Steel (SS)
24"	87 SS 24
36"	87 SS 36
48"	87 SS 48
60"	87 SS 60
72"	87 SS 72



1987 Series Stainless Steel Shelving

Material: 14 gauge, 304 grade stainless steel
Finish: Stainless Steel (SS) with brushed finish
Origin: Made in the USA
Features: Predrilled mounting holes to fasten to brackets; shelves are shipped with protective vinyl wrap

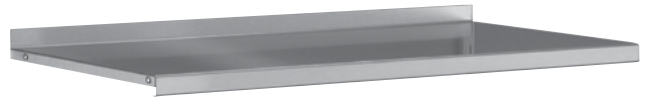

Pack Configurations

Standard	5 per carton; except 20" x 32": 3 per carton
1987 Series Stainless Steel Shelving Standard Pack	
Size	Stainless Steel (SS)
8" x 32"	1987 SS 8X32
10" x 32"	1987 SS 10X32
12" x 32"	1987 SS 12X32
16" x 32"	1987 SS 16X32
20" x 32"	1987 SS 20X32

*Standards and brackets meet or exceed ANSI performance standards as established by BHMA testing requirements.

87™ /186™ /187™ Super-Duty Stainless Steel Standard and Bracket System

186LL and 187LL Series Stainless Steel Lock Lever Brackets

- Material:** 14 gauge 304 grade stainless steel
Finish: Brushed Stainless Steel (SS)
Origin: Made in the USA
Features: Holds up to 560 lbs. per pair of brackets*; lever lock for easy installation, stability and safety; predrilled holes for mounting 1987 Series shelves or attaching shelf rests; two or three complete locking teeth



Pack Configurations

Standard	10 per carton, no UPC labels
186 Series Brackets Standard Pack	
Size	Stainless Steel (SS)
8"	186LL SS 8
10"	186LL SS 10
187 Series Brackets Standard Pack	
12"	187LL SS 12
14"	187LL SS 14
16"	187LL SS 16
18"	187LL SS 18
20"	187LL SS 20
24"	187LL SS 24

NOTE: Stainless Steel brackets do not work with 87 steel standards.

186LL SS



187LL SS



□ Non-stock item – minimum order quantities and additional lead time may apply.

*Standards and brackets meet or exceed ANSI performance standards as established by BHMA testing requirements.

5mm Shelf Supports for Built-In Shelving

326 ANO and 326 BR Grommets

Grommet Diameter: For 7/32" (5.556mm) holes
Pin Diameter: Designed for 5mm pin diameters
Finish: Anochrome (ANO), Brass-look (BR)
Packed: 1000 per bag, 4 bags per carton



339 WH Plastic Locking Shelf Support for 3/4" Shelves

Pin Diameter: Designed for 5mm holes
Pin Length: 1/4"
Finish: White (WH)
Packed: 100 per bag, 25 bags per carton



330 ANO and 330 STB Shelf Supports

Pin Diameter: Designed for 5mm holes
Finish: Anochrome (ANO), Statuary Bronze (STB)
Packed: 2000 per bag, 4 bags per carton



340 WH Plastic Locking Shelf Supports for 1" Shelves

Pin Diameter: Designed for 5mm holes
Pin Length: 1/4"
Finish: White (WH)
Packed: 100 per bag, 5 bags per carton



332 ANO and 332 BR Shelf Supports

Pin Diameter: Designed for 5mm holes
Pin Length: 5/16" (8mm)
Shelf Rest: 5/16" (8mm) wide x 7/16" (11mm) long
Finish: Anochrome (ANO), Brass-look (BR)
Packed: 1000 per bag, 4 bags per carton



345 Series Metal Shelf Pins*

Pin Diameter: Designed for 5mm holes
Pin Length: 5/16" (8mm)
Shelf Rest: 1/2" (13mm) wide x 11/16" (17mm) long
Finish: Nickel Plated (NP), Brass-Look (BR), Walnut (WAL)



338 Series Plastic Shelf Support Pins

Pin Diameter: Designed for 5mm holes
Pin Length: 5/16" (8mm)
Shelf Rest: 7/16" (11mm) wide x 13/32" (10mm) long
Finish: Almond (ALM), Brown (BRN), Clear Plastic (CL), White (WH)



Pack Configurations

Standard	100 pieces per carton		
Poly (P)	12 supports per bag; 10 bags per carton		
345 Series Shelf Support			
Pack Configuration	Nickel Plated (NP)	Brass-Look (BR)	Walnut (WAL)
Standard Pack	345 NP	345 BR	345 WAL
Poly (P) Pack	345P NP	345P BR	345P WAL

Pack Configurations

Standard	100 pieces per carton			
Poly (P)	12 supports per bag; 10 bags per carton			
338 Series Shelf Support				
Pack Configuration	Almond (ALM)	Brown (BRN)	Clear Plastic (CL)	White (WH)
Standard Pack	338 ALM	338 BRN	338 CL	338 WH
Poly (P) Pack	-	-	338P CL	338P WH

348 ALM, 348 BRN and 348 WH Vinyl Coated Shelf Supports

Pin Diameter: Designed for 5mm holes; use 13/64" diameter drill bit
Pin Length: 5/16" (8mm)
Shelf Rest: 1/2" (13mm) wide x 11/16" (17mm) long
Finish: Almond (ALM), Brown (BRN), White (WH)
Packed: 1000 pieces per carton



1/4" and 7/32" Shelf Supports and Grommets

325 ANO and 325 BR Grommets

Grommet Diameter: For 9/32" (7.143mm) holes
Pin Diameter: Designed for 1/4" pin diameters
Finish: Anochrome (ANO), Brass-look (BR)
Packed: 1000 per bag, 4 bags per carton



333 ZC and 333 BR Shelf Supports

Pin Diameter: Designed for 7/32" holes; use 15/64" diameter drill
Pin Length: 1/2" (13mm)
Shelf Rest: 9/16" (14mm) wide x 7/16" (11mm) long
Finish: Zinc (ZC), Brass-look (BR)
Packed: 1000 per carton



331 ANO and 331 BR Shelf Supports

Pin Diameter: Designed for 1/4" holes
Pin Length: 3/8" (9mm)
Shelf Rests: 3/8" (9mm) wide x 1/2" (13mm) long
Finish: Anochrome (ANO), Brass-look (BR)
Packed: 1000 per bag, 4 bags per carton



335 Series Plastic Shelf Support Pins

Pin Diameter: Designed for 1/4" holes
Pin Length: 7/16" (11mm)
Shelf Rest: 1/2" (13mm) wide x 17/32" (14mm) long
Finish: Clear Plastic (CL), Plastic (PLAS), White (WH)



Pack Configurations

Standard	10 pieces per carton
Poly (P)	12 supports per bag; 10 bags per carton
Warehouse Pack (WP)	12 supports per bag; 50 bags per carton
335 Series Shelf Support	
Pack Configuration	Clear Plastic (CL) Plastic (PLAS) White (WH)
Standard Pack	335 CL 335 PLAS 335 WH
Poly (P) Pack	335P CL 335P PLAS 335P WH
Warehouse Pack (WP)	335WP CL - 335WP WH

346 Series Metal Shelf Pins*

Pin Diameter: Designed for 1/4" holes
Pin Length: 3/8" (9mm)
Shelf Rest: 1/2" (13mm) wide x 11/16" (17mm) long
Finish: Anochrome (ANO), Brass-Look (BR), Walnut (WAL)



Pack Configurations

Standard	100 pieces per carton
Poly (P)	12 supports per bag; 10 bags per carton
346 Series Shelf Support	
Pack Configuration	Anochrome (ANO) Brass-Look (BR) Walnut (WAL)
Standard Pack	346 ANO 346 BR 346 WAL
Poly (P) Pack	346P ANO 346P BR 346P WAL

Utility Shelving Brackets

204 Series Reinforced Heavy-Duty L-Bracket

- Material:** 12 gauge steel
Finish: Anochrome (ANO)
Origin: Made in the USA
Features: Shelf retaining lip; keyhole slot for easy installation; predrilled screw holes in top of bracket for easy fastening to wood shelves; BHMA Grade 2 Compliant*



Pack Configurations

Standard	24 per carton
204 Series Brackets	
Size	Anochrome (ANO)
4"	204 ANO 4
6"	204 ANO 6
8"	204 ANO 8
10"	204 ANO 10
12"	204 ANO 12

206 Series Extra-Duty Folding L-Bracket

- Finish:** Zinc (ZC), White (WH)
Features: Holds up to 750 lbs. per pair*; 4 adjustable positions: 90°, 80°, 70°, and 0° (closed position)**; all steel construction with spring-loaded release lever; predrilled screw holes in top of bracket for easy fastening to wood shelves; BHMA Grade 2 Compliant*

206 ZC



206 WH



Pack Configurations

Standard	10 per display carton with UPC labels attached	
206 Series Folding L-Brackets		
Size	Zinc (ZC)	White (WH)
12"	206 ZC 12	206 WH 12
16"	206 ZC 16	206 WH 16

**Angle has a tolerance of +1°. May need to shim for level installations.

*Standards and brackets meet or exceed ANSI performance standards as established by BHMA testing requirements.

Utility Shelving Brackets

208 Series Ultimate L-Bracket

Finish: Black (BLK), Titanium (TI), White (WH)

Features: Holds up to 1,200 lbs. per pair*; super-duty bracket; corrosion resistant Epoxy-Coated finish; 5mm steel bar and 3/4" steel strut; BHMA Grade 2 Compliant*

Pack Configurations

Standard	10 per display carton with UPC labels		
208 Series Bracket			
Size	Black (BLK)	Titanium (TI)	White (WH)
300mm	208 BLK 300	208 TI 300	208 WH 300
400mm	208 BLK 400	208 TI 400	208 WH 400
500mm	208 BLK 500	208 TI 500	208 WH 500
550mm	208 BLK 550	208 TI 550	208 WH 550

208 BLK



208 TI



208 WH



221 Series Utility L-Bracket

Finish: Gray (GRY), White (WH)

Features: Holds up to 120 lbs. per pair*; regular-duty bracket; durable powder coat finish

Pack Configurations

Standard	20 per carton with UPC labels	
221 Series Bracket		
Size	Gray (GRY)	White (WH)
5" x 6"	221 GRY 5X6	221 WH 5X6
6" x 8"	221 GRY 6X8	221 WH 6X8
8" x 10"	221 GRY 8X10	221 WH 8X10
10" x 12"	221 GRY 10X12	221 WH 10X12
12" x 14"	221 GRY 12X14	221 WH 12X14

221 WH



221 GRY

*Standards and brackets meet or exceed ANSI performance standards as established by BHMA testing requirements.

Decorative Shelf Brackets

88 and 888 Series Wood Shelf Anchor

Finish: Almond (ALM), Black (BLK), White (WH)
Features: Regular-duty bracket; 88 anchors for use with 5/8" thick shelves (KV1980); 888 anchors for use with 3/4" thick shelves (KV1990); an almost invisible shelf support; all hardware included

Pack Configurations

Standard	5 per carton		
88 Series Anchor Standard Pack			
Size	Almond (ALM)	Black (BLK)	White (WH)
24"	88 ALM 24	88 BLK 24	88 WH 24
36"	88 ALM 36	88 BLK 36	88 WH 36
48"	88 ALM 48	88 BLK 48	88 WH 48
888 Series Anchor Standard Pack			
24"	—	888 BLK 24	888 WH 24
36"	—	888 BLK 36	888 WH 36

ALM 



BLK 



WH 



216 Series Simplicity™ Shelf Bracket

Finish: White (WH)
Features: BHMA Grade 2 Compliant*; heavy-duty steel; accented with decorative plastic trim that hides mounting hardware

Pack Configurations

Poly	10 pair per carton (all sizes) with header card	
216 Series Bracket Poly Pack (P)		
Size	White (WH)	
8"	216P WH 8	
10"	216P WH 10	



215 Series Slim-Line™ Shelf Bracket

Finish: Black (BLK), White (WH)
Features: BHMA Grade 2 Compliant*; accented with decorative plastic trim that hides mounting hardware

Pack Configurations

Standard	8"–30 per carton; 10"–24 per carton; 12"–18 per carton	
Special Pack	10 per carton (all sizes)	
215 Series Bracket Standard Pack		
Size	Black (BLK)	White (WH)
8"	215 BLK 8	215 WH 8
10"	215 BLK 10	215 WH 10
12"	215 BLK 12	215 WH 12
215 Series Bracket Special Pack (SP)		
8"	215SP BLK 8	215SP WH 8
10"	215SP BLK 10	215SP WH 10
12"	215SP BLK 12	215SP WH 12

BLK



WH



217 Series Silhouette™ Shelf Bracket

Finish: Black (BLK), White (WH)
Features: BHMA Grade 2 Compliant*; heavy-duty steel; center rib for superior strength; countersunk screw holes

Pack Configurations

Standard	8"–30 per carton; 10"–24 per carton; 12"–18 per carton	
Special Pack	10 per carton (all sizes)	
217 Series Bracket Standard Pack		
Size	Black (BLK)	White (WH)
8"	217 BLK 8	217 WH 8
10"	217 BLK 10	217 WH 10
12"	217 BLK 12	217 WH 12
217 Series Bracket Special Pack (SP)		
8"	217SP BLK 8	217SP WH 8
10"	217SP BLK 10	217SP WH 10
12"	217SP BLK 12	217SP WH 12

BLK



WH



*Standards and brackets meet or exceed ANSI performance standards as established by BHMA testing requirements.

200 Series Designer Decorative Shelf Brackets

Concord 200C Series Decorative Brackets

Finish: Antique Bronze (AB), Black (BLK), Satin Nickel (SN), White (WH)
Features: Holds up to 50 lbs. per pair*; BHMA Grade 1 Compliant*; distinct traditional styles fit any decor; screw holes for easy mounting; 6" size for 6"–8" deep shelves; 8" size for 8"–12" shelves

Pack Configurations

Standard	10 carded pieces per carton			
200C Series Concord Decorative Shelf Bracket				
Size	Antique Bronze (AB)	Black (BLK)	Satin Nickel (SN)	White (WH)
6"	200C AB 6	200C BLK 6	200C SN 6	200C WH 6
8"	200C AB 8	200C BLK 8	200C SN 8	200C WH 8

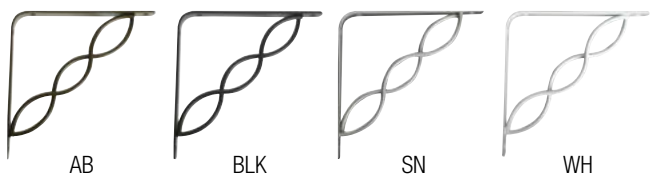

Manchester 200M Series Decorative Brackets

Finish: Antique Bronze (AB), Black (BLK), Satin Nickel (SN), White (WH)
Features: Holds up to 50 lbs. per pair*; BHMA Grade 1 Compliant*; distinct traditional styles fit any decor; screw holes for easy mounting; 6" size for 6"–8" deep shelves; 8" size for 8"–12" shelves

Pack Configurations

Standard	10 carded pieces per carton			
200M Series Manchester Decorative Shelf Bracket				
Size	Antique Bronze (AB)	Black (BLK)	Satin Nickel (SN)	White (WH)
6"	200M AB 6	200M BLK 6	200M SN 6	200M WH 6
8"	200M AB 8	200M BLK 8	200M SN 8	200M WH 8

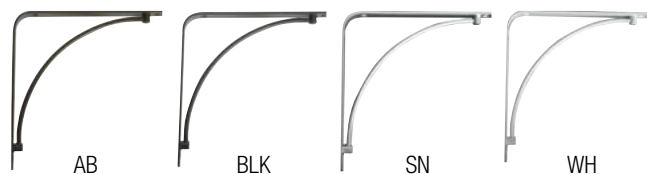

Oak Park 2000P Series Decorative Brackets

Finish: Antique Bronze (AB), Black (BLK), Satin Nickel (SN), White (WH)
Features: Holds up to 100 lbs. per pair*; BHMA Grade 1 Compliant*; distinct contemporary styles fit any decor; screw holes for easy mounting; 6" size for 6"–8" deep shelves; 8" size for 8"–12" shelves; cast zinc insets

Pack Configurations

Standard	10 carded pieces per carton			
2000P Series Oak Park Decorative Shelf Bracket				
Size	Antique Bronze (AB)	Black (BLK)	Satin Nickel (SN)	White (WH)
6"	2000P AB 6	2000P BLK 6	2000P SN 6	2000P WH 6
8"	2000P AB 8	2000P BLK 8	2000P SN 8	2000P WH 8

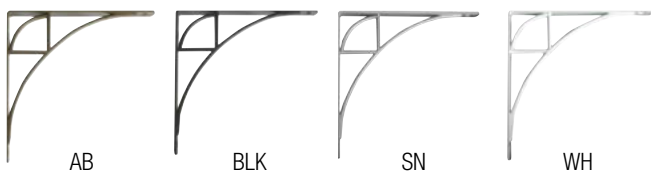

Stockton 200S Series Decorative Brackets

Finish: Antique Bronze (AB), Black (BLK), Satin Nickel (SN), White (WH)
Features: Holds up to 100 lbs. per pair*; BHMA Grade 1 Compliant*; distinct contemporary styles fit any decor; screw holes for easy mounting; 6" size for 6"–8" deep shelves; 8" size for 8"–12" shelves; cast zinc insets

Pack Configurations

Standard	10 carded pieces per carton			
200S Series Stockton Decorative Shelf Bracket				
Size	Antique Bronze (AB)	Black (BLK)	Satin Nickel (SN)	White (WH)
6"	200S AB 6	200S BLK 6	200S SN 6	200S WH 6
8"	200S AB 8	200S BLK 8	200S SN 8	200S WH 8

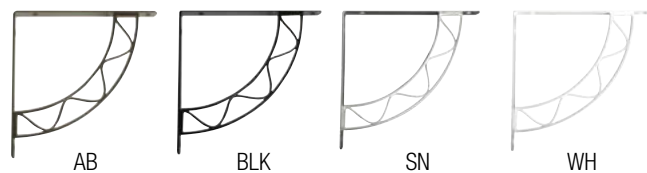

Finish:



*Standards and brackets meet or exceed ANSI performance standards as established by BHMA testing requirements.

200 Series Designer Decorative Shelf Brackets

Baton Rouge 200BR Series Decorative Brackets

Finish: Antique Bronze (AB), Black (BLK), Satin Nickel (SN), White (WH)
Features: Holds up to 200 lbs. per pair*; BHMA Grade 2 Compliant*; distinct elegant styles fit any decor; screw holes for easy mounting; 8" size for 8"-12" shelves; cast zinc insets

Charleston 200CH Series Decorative Brackets

Finish: Antique Bronze (AB), Black (BLK), Satin Nickel (SN), White (WH)
Features: Holds up to 200 lbs. per pair*; BHMA Grade 2 Compliant*; distinct elegant styles fit any decor; screw holes for easy mounting; 8" size for 8"-12" shelves; cast zinc insets

Pack Configurations

Standard	10 carded pieces per carton			
200BR Series Baton Rouge Decorative Shelf Bracket				
Size	Antique Bronze (AB)	Black (BLK)	Satin Nickel (SN)	White (WH)
8"	200BR AB 8	200BR BLK 8	200BR SN 8	200BR WH 8

Pack Configurations

Standard	10 carded pieces per carton			
200CH Series Charleston Decorative Shelf Bracket				
Size	Antique Bronze (AB)	Black (BLK)	Satin Nickel (SN)	White (WH)
8"	200CH AB 8	200CH BLK 8	200CH SN 8	200CH WH 8

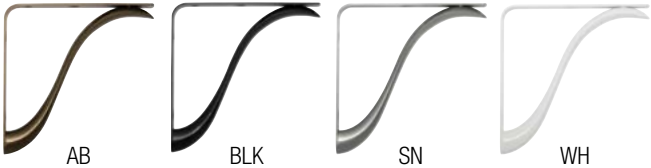
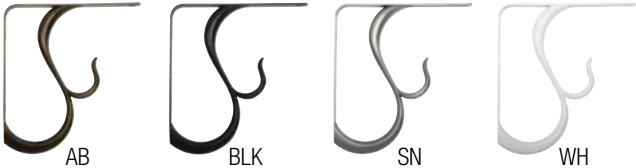

Finish:

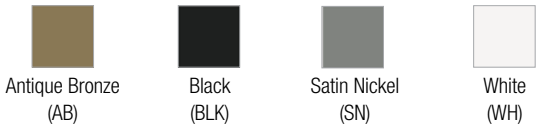

*Standards and brackets meet or exceed ANSI performance standards as established by BHMA testing requirements.

Shelf Board

1980 Series All-Purpose Shelf Board

Finish: Diamond Ash (DA), Espresso (ESP), Maple (MPL), Oak (OK), Walnut (W), White (WH)

Origin: Made in China

Features: Holds up to 200 lbs. when properly installed; 5/8" thick with square corners; scratch and stain resistant for long life; easy to clean surface



Pack Configurations

Standard	5 per carton, with the exception: 12" x 72" packed 3 per carton					
1980 Series Shelving Standard Pack						
Size	Diamond Ash (DA)	Espresso (ESP)	Maple (MPL)	Oak (OK)	Walnut (W)	White (WH)
8" x 24"	1980 DA 8X24	1980 ESP 8X24	1980 MPL 8X24	1980 OK 8X24	1980 W 8X24	1980 WH 8X24
8" x 36"	1980 DA 8X36	1980 ESP 8X36	1980 MPL 8X36	1980 OK 8X36	1980 W 8X36	1980 WH 8X36
8" x 48"	1980 DA 8X48	1980 ESP 8X48	1980 MPL 8X48	1980 OK 8X48	1980 W 8X48	1980 WH 8X48
10" x 24"	1980 DA 10X24	1980 ESP 10X24	1980 MPL 10X24	1980 OK 10X24	1980 W 10X24	1980 WH 10X24
10" x 36"	1980 DA 10X36	1980 ESP 10X36	1980 MPL 10X36	1980 OK 10X36	1980 W 10X36	1980 WH 10X36
10" x 48"	1980 DA 10X48	1980 ESP 10X48	1980 MPL 10X48	1980 OK 10X48	1980 W 10X48	1980 WH 10X48
12" x 24"	1980 DA 12X24	1980 ESP 12X24	1980 MPL 12X24	1980 OK 12X24	1980 W 12X24	1980 WH 12X24
12" x 36"	1980 DA 12X36	1980 ESP 12X36	1980 MPL 12X36	1980 OK 12X36	1980 W 12X36	1980 WH 12X36
12" x 48"	1980 DA 12X48	1980 ESP 12X48	1980 MPL 12X48	1980 OK 12X48	1980 W 12X48	1980 WH 12X48
12" x 72"	-	-	-	-	-	1980 WH 12X72