

*PORTABLE
KEROSENE-HEATER
“OWNER’S MANUAL”*

Kero-World[®]

**MODEL:
KW - 12**



Before the first use of this heater, please read this OWNER'S MANUAL very carefully. This OWNER'S MANUAL has been designed to instruct you as to the proper manner in which to assemble the heater, maintain the heater, store the heater, and most importantly, how to operate the heater in a safe and efficient manner, please keep this manual for future reference.



CALIFORNIA RESIDENTS ONLY-WARNING: This product and the fuel used to operate this product (kerosene), and the products of combustion of such fuel, can expose you to chemicals including benzene, which is known to the State of California to cause cancer and reproductive harm. For more information go to: www.P65Warnings.ca.gov

**World Marketing of America, Inc.
RT.22 West, P.O. Box 192
Mill Creek, PA 17060
Telephone : 814-643-1775 (9AM - 4PM EST)
www.worldmkting.com**

CAUTIONS - SAFETY GUIDE -

1 WARNING!! RISK OF EXPLOSION / RISK OF FIRE

- ! NEVER** use any fuel other than 1-K kerosene.
- ! NEVER** use fuel such as gasoline, benzene, paint thinners or other oil compounds in this heater.
- ! NEVER** refill heater fuel tank when heater is operating or still hot.
- ! NEVER** use heater in areas where flammable vapors or gases may be present.
- ! NEVER** fill heater fuel tank in living space; fill tank outdoors.
- ! NEVER** store or transport kerosene in other than a metal or plastic container that is (1) acceptable for kerosene, (2) non-red in color, and (3) clearly marked "Kerosene". **NEVER** store kerosene in the living space; kerosene should be stored in a well ventilated place outside the living area.

! The unit is EXTREMELY HOT while in operation. Due to high surface temperatures, keep children, clothing, furniture, and other combustible objects at least 36" away from top and front area.

! RISK OF IN DOOR AIR POLLUTION

USE HEATER ONLY IN WELL VENTILATED AREAS. People with breathing problems should consult a physician before using the heater. In a house of typical construction, that is, one that is not of unusually tight construction due to heavy insulation and tight seals against air infiltration, an adequate supply of air for combustion and ventilation is provided through infiltration; however, if the heater is used in a small room where less than 200 cubic feet (5.7 m³) of air space is provided for each 1,000 BTU per hour of heater rating (considering the maximum burner adjustment), the door(s) to adjacent room(s) should be kept open or the window to the outside should be opened at least 1 inch (25.4 mm) to guard against potential buildup of indoor air pollution. **DO NOT** use the heater in a bathroom or any other small room with the door closed.

! NEVER use heater to heat or boil water or use as a cooking appliance.

2 WARNING!!

FAILURE TO INSTALL, MAINTAIN, AND/OR

OPERATE THIS KEROSENE HEATER ACCORDING TO MANUFACTURER'S INSTRUCTIONS MAY

RESULT IN CONDITIONS WHICH CAN PRODUCE BODILY INJURY AND/OR PROPERTY DAMAGE.

NOTE: The **WARNING** and **IMPORTANT** instructions appearing in this manual are not meant to cover all possible conditions and situations that may occur. It must be understood that common sense, caution, and carefulness are factors which cannot be built into this heater. These factors must be supplied by the person(s) installing, maintaining, or operating the kerosene heater.

Always contact your dealer, distributor, service agent, or the manufacturer on any problems or conditions you do not understand.

! NEVER leave heater operating if you intend to leave for any period of time. Always make sure to turn heater off and inspect to insure that it is completely extinguished prior to going to bed.

! NEVER leave heater unattended.

! NEVER use as a source of heat for drying objects.

! NEVER place objects on the top plate.

3 WARNING!! RISK OF BURNS

! NEVER operate the heater without the guard or grille completely attached.

4 IF POOR QUALITY KEROSENE is used a rapid accumulation of carbon and tar is likely. This may cause a strong odor and will destroy the wick. Additional heater damage may occur as the wick becomes more difficult to adjust. The use of poor quality fuel could also make the wick very hard to extinguish. Always make sure the fire is out. (See page 12, Extinguishing the Heater.)

5 ADJUSTMENT OF ROOM TEMPERATURE can not be changed by adjusting the heater. A Kerosene heater is either on or off. There is no temperature adjustment. If heater output is reduced by lowering the wick in any way, improper combustion will occur producing odors and an accumulation of tar and carbon. If your room becomes too hot, open a door or a window or turn off the heater.

SAVE THESE INSTRUCTIONS FOR FUTURE REFERENCE!!

WARNINGS

IMPORTANT : READ AND UNDERSTAND ALL WARNINGS AND OPERATING INSTRUCTIONS PRIOR TO OPERATING THIS HEATER.

WARNING

FAILURE TO INSTALL, MAINTAIN, AND/OR OPERATE THIS KEROSENE HEATER IN ACCORDANCE WITH THE MANUFACTURER'S WARNINGS AND OPERATING INSTRUCTIONS MAY RESULT IN CONDITIONS WHICH CAN PRODUCE SERIOUS BODILY INJURY AND/OR PROPERTY DAMAGE.

NOTE: The **WARNINGS** and **IMPORTANT OPERATING INSTRUCTIONS** appearing in this Manual are not meant to cover all possible conditions and situations that may occur. It must be understood that common sense, caution and care are factors which cannot be built into this heater. These factors must be supplied by the person(s) installing, maintaining, or operating the kerosene heater.

Always contact your dealer, distributor, service agent or the manufacturer on any problems or conditions you do not understand.

FLARE-UP

"Flare-up" has been defined by the U.S. Consumer Product Safety Commission as the sudden uncontrolled eruption of flames beyond the heater's cabinet.

DANGER. Flare-up (i.e., flames erupting outside the heater body) will result if gasoline or other volatile fuel is used in heater. Flare-up can ignite combustible materials close to the heater and start fires. Use only pure, water-clear 1-K kerosene;

NEVER use gasoline in the heater or let it mix with the kerosene. Keep fuels separate, store fuels separately (Fig. A) and never operate heater while it is unattended. (Fig.F)

The usage of Gasoline can lead to flare-up in a kerosene heater leading to a destructive fire.

1. **NEVER** operate the heater without a working fire extinguisher and smoke detector nearby. (Fig.B)
2. **NEVER** use any fuel other than water-clear 1-K kerosene. **ALWAYS** check kerosene for clarity at the point of purchase. **NEVER** use fuels such as gasoline, benzene, paint thinners or other oil compounds in the heater. (For details, see section entitled "Kerosene" in the Owner's Manual.)
3. **ALWAYS** use a **BLUE** container labeled "**KEROSENE**" for the purchase and storage of kerosene for your heater.
4. **NEVER** use a **RED** container for kerosene purchase or storage.

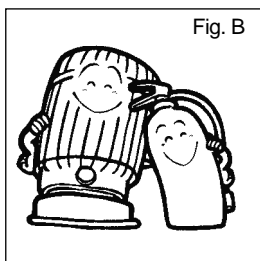
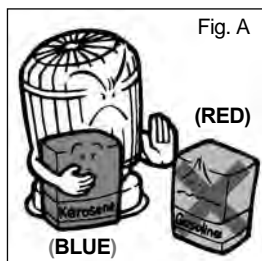

5. **NEVER** operate the heater in a doorway or in any windy place.
6. **NEVER** attach blower units or make any other modifications to the heater.
7. If flare-up occurs, do not attempt to move or carry the heater.
8. **DANGER. NEVER** operate heater at a wick-setting lower than the minimum wick-setting.

FIRES

DANGER. Risk of fire. Keep heater at least 36" away from drapes, furniture or other combustible materials.

Never add fuel indoors and never add fuel while heater is still operating or when it is still hot. (Fig C)

1. **NEVER** use a **RED** container for the purchase and storage of kerosene for your heater.
2. **NEVER** operate the heater without a working fire extinguisher and smoke detector nearby.
3. **NEVER** use the heater in areas where flammable vapors or high dust conditions are present.
4. **NEVER** fill the heater fuel tank in living space; fill fuel tank outdoors. (Fig.D)

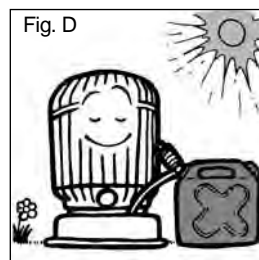
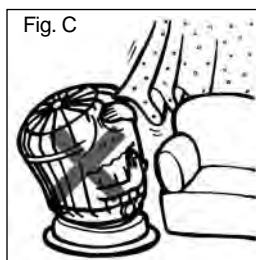

NEVER LEAVE THE HEATER UNATTENDED WHILE BURNING!

5. **NEVER** store or transport kerosene in other than a metal or plastic container that is (1) acceptable for kerosene, (2) **BLUE** in color, and (3) clearly marked "Kerosene". **NEVER** store kerosene in the living space; kerosene should be stored in a well-ventilated place outside the living area.
6. **ALWAYS** keep kerosene in a **BLUE** container in an area where no other fuels, solvents or paint thinners are stored to prevent the accidental fueling of your heater with a dangerous fuel.
7. The heater becomes **EXTREMELY HOT** while in operation. Due to high surface temperatures, keep children away from the heater and keep clothing, furniture, and other combustible objects at least 36" away from the top and sides of the heater.
8. **NEVER** operate the heater in a bathroom or in any other small room where less than 200 cubic feet (5.7m³) of air space is provided for each 1,000 BTU per hour of heater rating. (Fig.E)
9. **NEVER** operate the heater while it is unattended, and **NEVER** leave the heater operating if you intend to leave the room for any period of time. (Fig.F)
10. **NEVER** leave the heater operating when you go to bed. (Fig.G)
11. **ALWAYS** allow heater to cool for at least 15 minutes before you move it, or remove its fuel tank for refueling, or servicing.
12. **ALWAYS** confirm extinguishment of the flame by raising the burner knob and checking visually, 10 to 15 seconds after turning off the heater.
13. **NEVER** place any objects on the top-plate or top-guard of the heater. (Fig.H)
14. **NEVER** permit minors to purchase fuel, do the refueling or operate your kerosene heater without adult supervision.

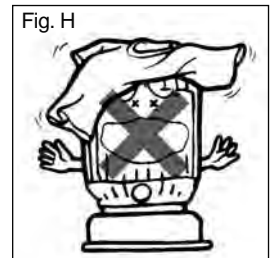
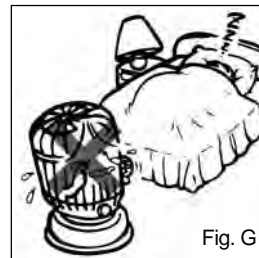
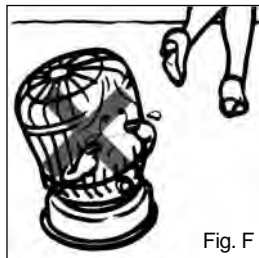
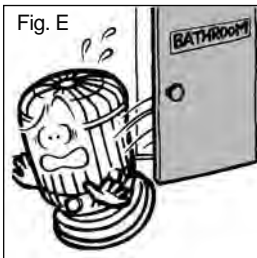

CONTACT BURNS

WARNING. High temperatures are present at top and body of heater. Direct contact with wire top-guard grille or side guards grille will result in serious burn injuries. Utilize protective barrier to restrict access to heater, and carefully supervise children when heater is in use.

1. **NEVER** operate the heater without the top-guard and body-guards (grilles) completely attached. (Fig.I)
2. **NEVER** attempt to move the heater while it is in operation. (Fig.J)
3. **NEVER** allow unsupervised children around or near the heater while it is in operation. (Fig.K)
4. **NEVER** attempt to refill the heater while it is still in operation or still hot. (Fig.L)

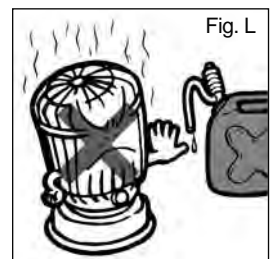
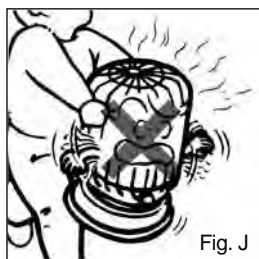
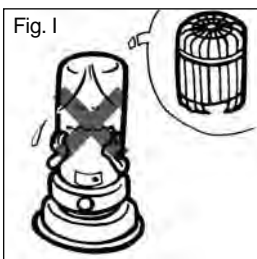

**NEVER LEAVE THE HEATER
UNATTENDED WHILE BURNING!**

ASPHYXIATION AND CARBON MONOXIDE POISONING

WARNING. Unvented heaters consume oxygen and produce carbon monoxide. Asphyxiation may result from breathing high levels of carbon monoxide. Use only in well-ventilated areas, and adjust wick in accordance with instructions in the Owner's Manual. Never operate heater at a wick-setting lower than the minimum wick-stop setting.

1. People with respiratory or circulatory problems should consult a physician before using the heater.
2. Houses with unusually tight construction due to heavy insulation and tight seals may have low levels of fresh air infiltration; therefore, provide an adequate supply of fresh air for combustion and ventilation by keeping the door(s) to adjacent room(s) open or a window to the outside open at least one inch, to guard against the potential build-up of carbon monoxide. (Fig.M)
3. **ALWAYS** make room temperature adjustments by extinguishing the heater or by opening windows, rather than by adjusting the wick.
4. **NEVER** adjust room temperature by means of the wick adjuster knob. This should only be used to maintain the proper flame (See 7 below). If heat is reduced excessively by means of the wick adjuster knob, it will cause imperfect combustion, which may result in the accumulation of carbon on the wick, unpleasant odors, and/or the generation of carbon monoxide.
5. **DANGER. NEVER** operate heater at a wick-setting lower than the minimum wick-setting.
6. **NEVER** operate the heater with the wick improperly adjusted. A low wick setting may produce carbon monoxide, which can cause dizziness, nausea, headaches or even death, in extreme cases.

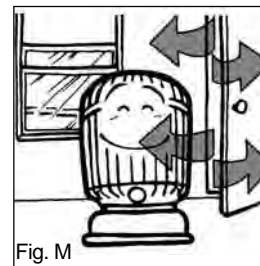

SOOT AND SMOKE

CAUTION. Soot and smoke emissions will result if contaminated kerosene (Never use kerosene that is even slightly colored or cloudy), if carbon deposits accumulate on wick, if wick is not adjusted properly, or if burner unit is not seated properly. Soot and smoke emissions can cause respiratory tract irritation and can damage property. Use only pure 1-K kerosene; remove carbon deposits on the wick periodically, in accordance with the operating instructions in the Owner's Manual; and adjust wick- setting periodically, in accordance with the operating instructions in the Owner's Manual. (Fig.N)

1. **NEVER** operate the heater while it is unattended.
2. **NEVER** operate the heater without a working smoke detector and fire extinguisher nearby.
3. **NEVER** use poor quality kerosene (i.e., kerosene that is aged, discolored, contaminated or that was obtained from an unknown source), which may cause excessive carbon build-up on the wick. Excessive carbon build-up may prevent proper wick retraction and heater extinguishment, resulting in the generation of strong odors and soot or smoke. (For details, see section entitled "Extinguishing The Heater" in the Owner's Manual.)
4. **ALWAYS** check kerosene to be sure it is colorless. **ALWAYS** check kerosene(colorless) for clarity at the point of purchase.
5. **ALWAYS** confirm extinguishment of the flame by lifting the burner knob and checking visually, prior to leaving the room for any period of time and before retiring to bed. (For details, see section entitled "Extinguishing The Heater" in the Owner's Manual.)
6. **ALWAYS** remove carbon build-up from the wick within 5 to 7 days of the first use, and after burning 5 or 6 tankfuls, during periods of regular usage. Carbon build-up on the wick can cause the production of soot and smoke. (For details see section entitled "Carbon Removal Dry Burning" in the Owner's Manual.)
7. **ALWAYS** make periodic adjustments of the wick during heater operation. Use the wick-adjuster knob to make basic adjustments within 5 to 7 minutes after ignition, and again after 30 minutes, if necessary. Because of changes in heater temperature and room temperature, flame height inspections and adjustments must be made periodically, thereafter. (For details, see section entitled "Adjusting the wick" in the Owner's Manual.)
8. **ALWAYS** remove and properly dispose of unused kerosene when storing your heater to avoid using the deteriorated kerosene after long-time storage, resulting in imperfect combustion. Kerosene held over can absorb water that may adversely affect system performance.
9. **NEVER** use an unauthorized replacement wick in this heater.

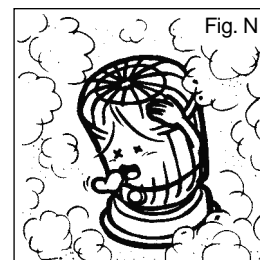

**NEVER LEAVE THE HEATER
UNATTENDED WHILE BURNING!**

CONSUMER PRODUCT SAFETY ALERT

From the U. S. Consumer Product Safety Commission Washington, D. C.

CPSC and NKHA STRESS KEROSENE HEATER SAFETY

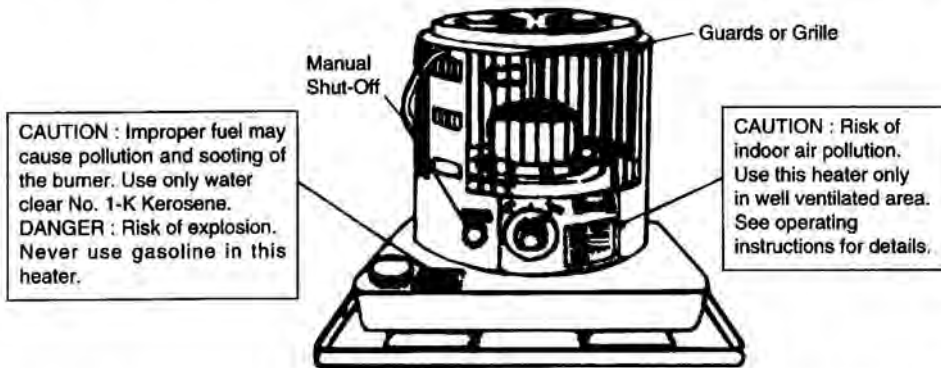

If you are using a kerosene heater, the U. S. Consumer Product Safety Commission and the National Kerosene Heater Association advise you to follow these suggestions in order to minimize the risk of fire and potential health effects from indoor air pollution.

- Use only water-clear 1-K grade kerosene. Never use gasoline. Gasoline is not the same as kerosene. Even small amounts of gasoline or other volatile fuels or solvents mixed with kerosene can substantially increase the risk of a fire or an explosion.
- Always store kerosene in a separate container intended for kerosene, not in a gasoline can or a can that has contained gasoline. This helps you avoid using contaminated fuel or the wrong fuel by mistake. Kerosene containers are usually blue. Gasoline containers are usually red.
- When purchasing kerosene at the pump, make sure to use the kerosene pump, not the gasoline pump. Some service stations have separate islands for kerosene. Some oil companies have also established quality control programs to minimize the chance of gasoline contamination of kerosene.
- 1-K grade kerosene should be purchased from a dealer who can certify that what is being sold is 1-K. State-operated and private sector certification programs that ensure the quality of kerosene are established in some states. Grades other than 1-K can lead to a release of more pollutants in your home, posing a possible health risk. Different grades of kerosene can look the same so it is important that the dealer certify that product sold is 1-K grade kerosene.
- Never refuel the heater inside the home. Fill the tank outdoors, away from combustible materials, and only after the heater has been turned off and allowed to cool down. Do not refuel the heater when it is hot or is in operation. Do not fill the fuel tank above the "full" mark. The space above the "full" mark is to allow the fuel room to expand without causing leakage when the heater is operating.
- In case of flare-up or if uncontrolled flaming occurs, do not attempt to move or carry the heater. This can make the fire worse. If the heater is equipped with a manual shut-off switch, activate the switch to turn off the heater. If this does not extinguish the fire, leave the house immediately and call the fire department. As an added reminder and precaution, install at least one smoke detector near each sleeping area or on each level of the house.
- Reduce your exposure to indoor air pollution by properly operating and maintaining your portable kerosene heater. Although portable kerosene heaters are very efficient in the burning of fuel to produce heat, low levels of certain pollutants such as carbon monoxide and nitrogen dioxide are produced. Exposure to low levels of these pollutants may be harmful, especially to individuals with chronic respiratory or circulatory health problems. To assure that you and your family members are not exposed to significant levels of these pollutants, you should follow carefully the following rules of safe operation.
 - Operate your heater in a room with a door open to the rest of the house.
 - If you must operate your heater in a room with the door closed to the rest of the house, open an outside window approximately an inch to permit fresh air to effectively dilute the pollutants below a level of concern.
 - Always operate your heater according to the manufacturer's instructions, making sure that the wick is set at the proper level as instructed by your manufacturer.
 - Keep the wick in your heater clean and in a good operating condition by following the cleaning and maintenance procedures recommended by the manufacturer.
 - Keep an outside window opened approximately an inch to insure adequate fresh air infiltration. This is true regardless of whether you use a kerosene heater or some other conventional method of heating, if your home is relatively new and tight, or if it is older but has been winterized to reduce air infiltration from the outside.

CONTENTS OF OWNER'S MANUAL

<u>ITEM</u>	<u>PAGE</u>	<u>ITEM</u>	<u>PAGE</u>
CAUTIONS-SAFETY GUIDE	2	10 CARBON REMOVAL / DRY BURNING	13
1 INTRODUCTION	7	11 WICK ASSEMBLY	14
2 FEATURES	7	12 WICK REPLACEMENT	14~16
3 UNPACKING AND ASSEMBLY	8~9	13 EXTINGUISHING THE HEATER	17
4 KEROSENE (1-K ONLY)	9	14 AUTOMATIC SAFETY SHUT-OFF DEVICE	17~18
5 FUELING YOUR HEATER	10	15 LONG TERM STORAGE OF YOUR HEATER	18
6 AUTOMATIC IGNITION SYSTEM	11	16 TROUBLE SHOOTING GUIDE	19
7 CHECKING THE IGNITION SYSTEM	11~12	17 PARTS LIST	20
8 ADJUSTING THE WICK	12~13	18 EXPLODED PARTS DRAWING	20
9 WICK MAINTENANCE	13	19 SPECIFICATIONS	20

1 INTRODUCTION

Please read this OWNER'S MANUAL carefully. It will show you how to assemble, maintain, and operate the heater safely and efficiently to obtain full benefit from its many built-in features.

2 FEATURES

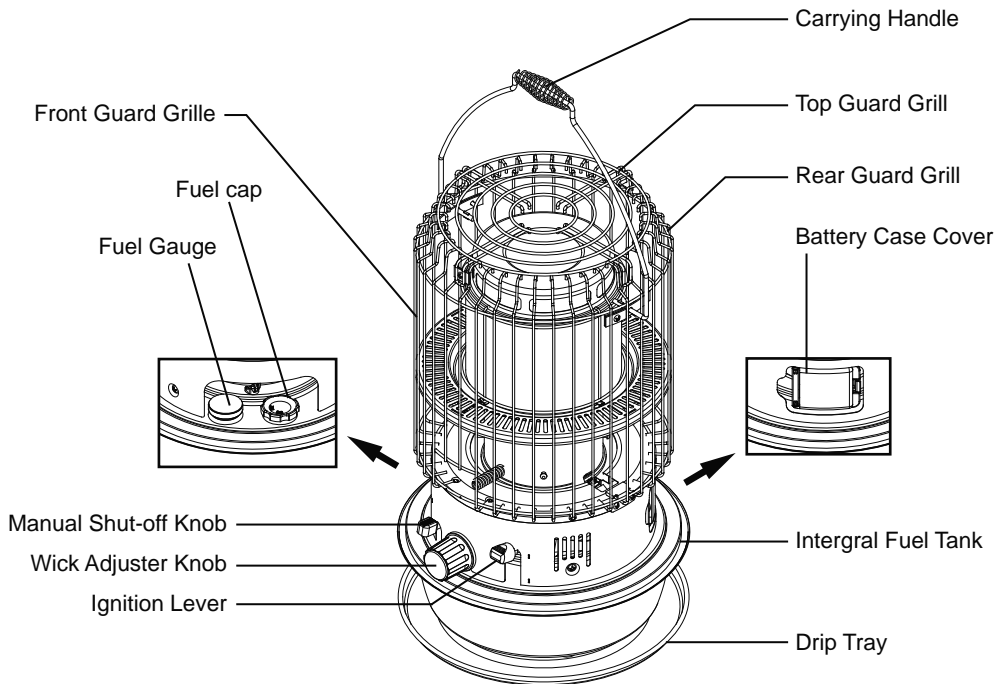

Fig. 1

**NEVER LEAVE THE HEATER
UNATTENDED WHILE BURNING!**

3 UNPACKING AND ASSEMBLY

CAUTION: "RISK OF BURNS"

DO NOT OPERATE HEATER WITHOUT THE PROTECTIVE
GUARD OR GRILLE.

1. REMOVE THE HEATER AND ALL PACKING MATERIALS FROM THE BOX. (Fig.2)

NOTE : Save the shipping carton and packing materials for
future storage.

- Heater
- 2 "C" cell batteries
- Siphon pump
- 2 Screws

2. ASSEMBLING PROCEDURE OF HEATER.

A) REMOVE THE TOP GRILL FROM HEATER AND UPPER PAD.

- Remove the PAD from the heater as described in Fig 3.
- Lift up Glass from Middle plate and remove Lower pad on
Middle plate. (Fig 3)
- FIG 4 related.
- Place the Glass on the Middle plate.
- Place Top plate on the Glass.
- Assemble Grill Glass fix on the Middle plate.
- Align and insert 4 bended rods to Clipped Guides on Middle
plate. (Fig 4)
- Align the 2 holes on Top Grill with the 2 mounting holes on
the Guard Grill as shown in Fig 5.
- Secure each holes with a screw.

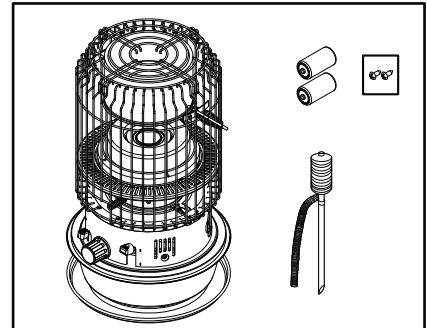

Fig. 2

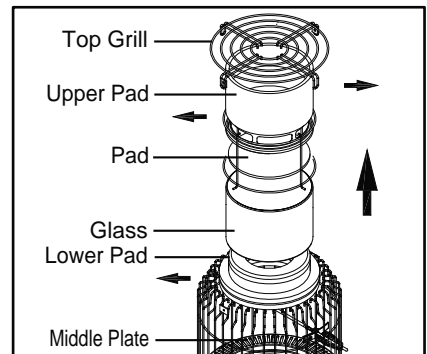

Fig. 3

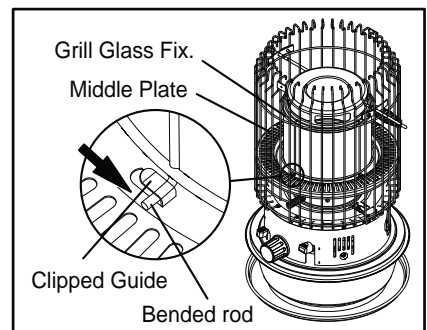

Fig. 4

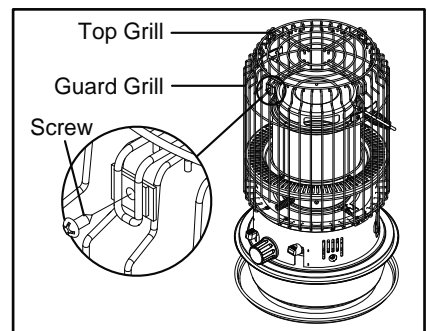

Fig. 5

**NEVER LEAVE THE HEATER
UNATTENDED WHILE BURNING!**

B) INSTALLING BATTERIES (Fig 6)

- Battery holder is located on the back of the heater.
- Open the battery cover from the battery holder.
- Insert two "C" cell batteries according to the plus(+) and minus(-) markings inside of the holder.
- Replace the battery cover to the heater.

C) Now your heater is completely ready to use.

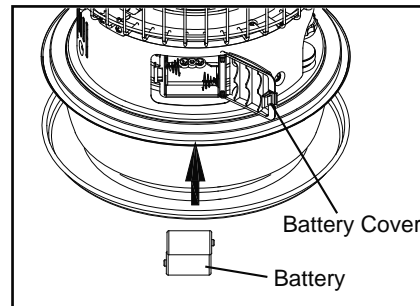

Fig. 6

4 KEROSENE (1-K ONLY)

It is **EXTREMELY IMPORTANT** to the operation of this heater that you use the proper grade of kerosene. The proper grade of kerosene is identified as **1-K Kerosene**. **DO NOT OPERATE THIS HEATER WITH ANY FUEL OTHER THAN 1-K KEROSENE!** 1-K Kerosene has been refined to virtually eliminate contaminants such as sulphur, which can cause a rotten egg odor during operation of the heater. **Due to IRS regulations 1-K kerosene is now dyed red in many areas.**

KEROSENE SHOULD ONLY BE STORED IN A BLUE CONTAINER THAT IS CLEARLY MARKED "KEROSENE". NEVER STORE KEROSENE IN A RED CONTAINER. Red containers are associated with gasoline.

NEVER store kerosene in the living space. Kerosene should be stored in a well ventilated place outside the living area.

NEVER use any fuel other than water-clear 1-K kerosene.

NEVER use fuel such as gasoline, benzene, alcohol, white gas, camp stove fuel, paint thinners, or other oil compounds in this heater. These are volatile fuels that can cause explosion or uncontrolled flames.

The best way to purchase kerosene is in a pre-packaged, metal or plastic, blue colored container. The second choice would be to buy it from a dealer who stores it in a 55 gallon drum. The third choice is to buy kerosene from a dealer who stores it in a large underground (or above ground) tank. Kerosene that is contaminated with even a small amount of water will prevent a kerosene heater from functioning properly. As you move from the first choice in purchasing kerosene (pre-packaged container) to the third choice (large storage tank), the likelihood of water being present from condensation increases. If you purchase kerosene in bulk, know your dealer.

It is normal for a kerosene heater to give off a slight odor upon start-up and shut-down.

After 5-10 minutes of operation, the heater should have reached its normal operating temperature and any odor should be very slight.

NEVER store kerosene in direct sunlight or near a source of heat.

NEVER use kerosene that has been stored from one season to the next.

Kerosene deteriorates over time. **"OLD KEROSENE" WILL NOT BURN PROPERLY IN THIS HEATER.**

A variety of problems can result from using poor quality kerosene --- smoke, odor, low flame, difficult ignition, difficult shut-down, flame flickers and dies, excessive burning down of the wick, reduced wick life, wick adjuster sticking, excessive deposits on the wick, etc.. If you encounter any of the problems listed above, check your kerosene. If you discover that the kerosene is the problem, get a fresh supply of **1-K KEROSENE** before using your heater again.

**NEVER LEAVE THE HEATER
UNATTENDED WHILE BURNING!**

5 FUELING YOUR HEATER

NEVER FILL THE HEATER FUEL TANK IN THE LIVING SPACE: FILL THE TANK OUTDOORS.

Before fueling the heater, take the heater, the kerosene, and the manual siphon pump outdoors. To use the manual siphon pump, tighten the cap on the top of the siphon, place the straight tube into the kerosene container, and insert the flexible tube into the opening of the fuel tank. By squeezing the bulb of the siphon pump, fuel will be transferred from the kerosene container into the heater tank. (Fig. 7) Carefully watch the fuel gauge beside the opening of the fuel tank so that you will know when the tank is getting full. When you approach the full mark, loosen the cap on top of the siphon pump. This will stop the flow of kerosene. **DO NOT OVERFILL YOUR HEATER.** Allow the siphon pump to drain thoroughly before you remove it from the tank and the kerosene container.

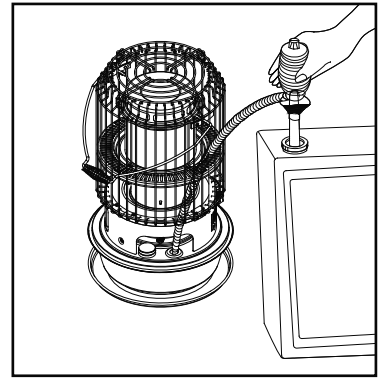

Fig. 7

After fueling the fuel tank of the heater by using siphon pump, make sure that you loosen (counter clock wise) the cap on the siphon pump to drain thoroughly the remaining kerosene in the siphon pump. For the reuse of siphon pump, make sure that you tighten (clock wise) the cap on the siphon pump to transfer the kerosene into the fuel tank properly. (Fig.8)

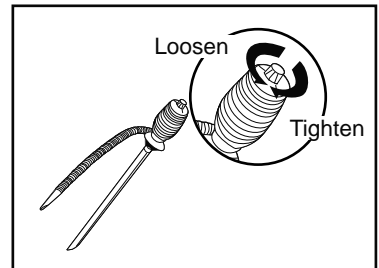

Fig. 8

IMPORTANT NOTICE REGARDING FUELING OF THE HEATER :

When fueling your heater for the first time and any other time when the tank has been completely empty, as in "Dry Burning" (page 13) make sure to **allow the wick to soak a minimum 60 minutes** before you attempt to light the heater. (Take note of the time you started to soak the wick or use a kitchen timer or wrist watch with an alarm feature) Failure to properly soak the wick can trap air pockets in the wick causing the heater to burn poorly. Premature ignition can destroy your wick.

IMPORTANT NOTICE REGARDING FIRST IGNITION OF HEATER

The first time you light your heater there may be some odor due to the burning off of oils used in the manufacturing process. To avoid this you may wish to burn the heater outside on a calm and windless day.

If it's windy consider a porch or garage or other room where the windows can be open to disperse the odor.

6 AUTOMATIC IGNITION SYSTEM

For safety and convenience, this heater features an automatic ignition system.

2 "C" cell batteries, included with the heater, provide the power for the igniter which lights the wick once it has been raised to its maximum height.

To use the automatic ignition system:

- Make sure the batteries have been installed.
- Turn the wick adjuster knob clockwise until the wick has been raised to its maximum height. (Fig. 9)
- Push the ignition lever (Fig. 10) to bring the glowing igniter into contact with the wick. This will cause ignition to occur.
- As soon as you see that the wick has been lit, release the ignition lever. This will automatically lower the burn chamber back down over the wick.
- Rotate the burner knob from side to side a few times to make sure that the burner is positioned properly on the wick adjuster. (Fig. 11)
- Then begin following the steps outlined in "Adjusting the wick" (page. 12)

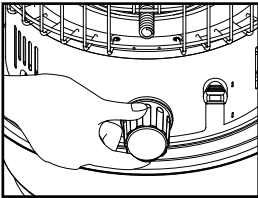

Fig. 9

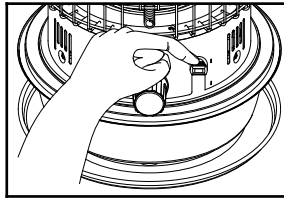

Fig. 10

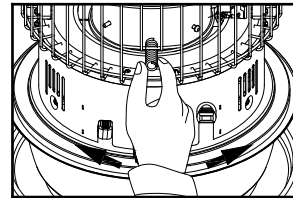

Fig. 11

IGNITION VIA MATCH

If you encounter a problem with the ignition mechanism, or if you have dead batteries, it is possible to light the heater with a match. (Fig.12)

The procedure is as follows:

- Turn the wick adjuster knob clockwise until the wick has been raised to its maximum height.
- Lift the burn chamber by using the burner knob.
- Touch a lighted match to the exposed top edge of the wick.
- Once you see that the wick has been lit, lower the burn chamber back down over the wick.
- Rotate the burner knob from side to side a few times to make sure that the burner is positioned properly on the wick adjuster.
- Then begin following the steps outlined in "Adjusting the wick" (page. 12)

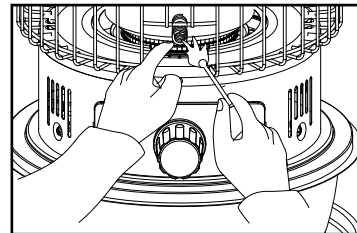

Fig. 12

CAUTION : Make sure that you do not leave the match, or any portion of it (match head, etc.) in the burner area. Debris left from the match can cause an uneven alignment of the burner and may result in smoke, incomplete combustion, odor, or fire.

7 CHECKING THE IGNITION SYSTEM

If the automatic ignition system fails to operate properly,

perform the following checks:

- **BATTERIES -2 "C"** cell batteries are located at the rear of the heater. Replace with new batteries. (Fig. 15)
- **IGNITER PLUG** - If the automatic ignition system still doesn't work after replacing the batteries, check the igniter plug. If the glow coil filament is broken, bent, or doesn't glow when engaged via the ignition lever, it must be replaced.

CAUTION: Be sure igniter plug is Type "B", 2.5V DC, 1A only.

NEVER LEAVE THE HEATER UNATTENDED WHILE BURNING!

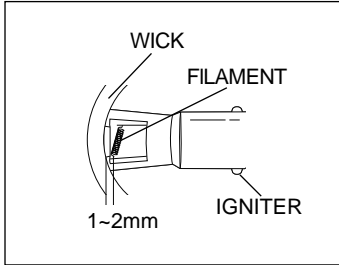

Fig. 13

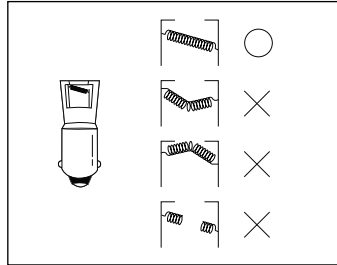

Fig. 14

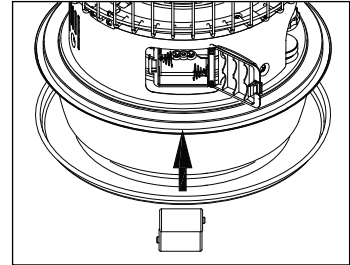

Fig. 15

To replace the igniter plug (Fig. 16):

- Remove the batteries.
- Remove the 2 Guard Bracket by removing 4 Screws and lift off the Guard grill assembly.
- Remove burner chamber and push the ignition lever to raise the igniter plug.
- Pull the igniter plug in and turn in a **clockwise** direction to remove.
- Install a new igniter plug (Type "B", 2.5V DC, 1A only) by pushing it in and turning it in a **counter-clockwise** direction.
- Reassemble the heater and replace the batteries.

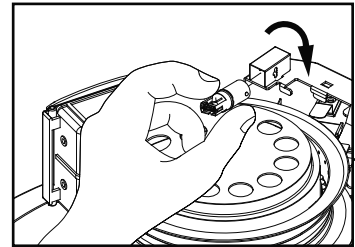

Fig. 16

- TEST IGNITION

Using the wick adjuster knob, raise the wick to its maximum height.

Push the ignition lever.

The igniter plug should be within 1~2mm of the wick when the ignition lever is fully engaged. (Fig. 13)

8 ADJUSTING THE WICK

After lighting the heater, it is important to check the heater flame within the first 5-7 minutes of operation. During the first 5 minutes after ignition, the burner chamber warms up and flames will become visible at the top of burner. These flames will gradually build up. After 5-7 minutes of operation, you should use the wick adjuster knob to obtain the proper flame height. The proper flame height is a 1/2" flame above the center flame spreader disk, with even distribution of flame around the flame spreader disk visible through the glass cylinder of the heater. See pictures below for reference.

As you continue to operate the heater, the temperature of the heater and the temperature of the room will continue to change. As the heater warms up, the kerosene in the tank will vaporize faster, and this could require adjusting the wick adjuster down in order to maintain the desired 1/2" flame height. Therefore, it is necessary to continue to monitor the flame height, and to make adjustments using the wick adjuster knob to keep the proper flame height. It is recommended that the heater be checked every 30 minutes in order to keep the proper adjustment because periodic adjustment is required.

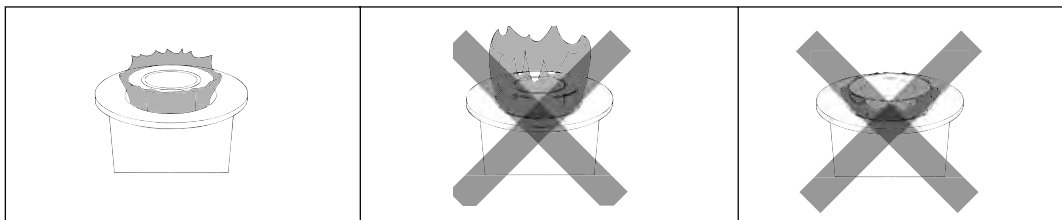

CORRECT FLAME
Proper combustion

FLAME TOO HIGH
Can Produce smoke
and soot

FLAME TOO LOW
Can produce odor
and carbon monoxide

IMPORTANT NOTE : NEVER LEAVE THE HEATER UNATTENDED WHILE BURNING.

Always make sure to turn the heater off and inspect it to insure that it is completely extinguished prior to going to bed.

**NEVER LEAVE THE HEATER
UNATTENDED WHILE BURNING!**

NOTE : During start-up, small adjustments to the flame can be performed by using the burner knob on the front of the burner and **MOVING THE BURNER FROM SIDE TO SIDE** until the flame at the top of burner is as even as possible. **DO NOT TOUCH THE BURNER KNOB ONCE THE HEATER HAS REACHED NORMAL OPERATING TEMPERATURE AND THE FLAME HAS STABILIZED. THE BURNER KNOB IS VERY HOT DURING OPERATION.**

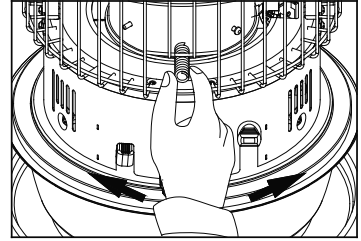

Fig. 17

IMPORTANT NOTE : This heater is designed to operate with a flame height of a 1/2" above the flame spreader disk at the top of the burner. For proper combustion to occur, it is **very important** that the flame height be adjusted so that it is neither too high, nor too low. Operating the heater at a wick setting below the minimum recommended setting (the wick-stop setting) could result in the risk of fire and / or carbon monoxide poisoning.

NOTE : If you find that the wick will not raise, push the safety reset lever (see diagram on P.2) to engage the safety shut-off device. Then dial the wick up via the wick adjuster knob.

WARNING : RISK OF INDOOR AIR POLLUTION AND FIRE, DO NOT OPERATE HEATER AT WICK SETTING LOWER THAN MINIMUM WICK-STOP SETTING.

9 WICK MAINTENANCE / DRY BURN

Wick maintenance is necessary to prevent soot production, low heat output and performance issues. Carbon and tar will build up on the top of the wick during regular use of this product. Wick maintenance is required within the first seven (7) days of your first use of the heater and every 2 tankfuls of fuel and/or every week during the heating season. If the wick feels hard and brittle, this indicates that wick maintenance is necessary in order to keep your heater performing accordingly.

Check Your Wick Often!

- ✓ If the wick is **hard to light** using the heater's ignition system...
- ✓ If the wick is **hard to raise** or difficult to adjust by turning the knob...
- ✓ If the wick fails to drop completely when you push the shut-off knob...
- ✓ If the top of the wick is **stiff & hard** like a bristle brush...
It is **time to DRY BURN** your heater. A wick that is in **good** condition will feel **soft** to the touch will light easily and extinguish quickly.

Note: Poor fuel or fuel contaminated with water will also turn the wick **hard**.

10 PERFORMING WICK DRY BURN / REMOVING CARBON FROM THE WICK

"Dry burning" your heater will cause a strong odor. For this reason it is best to "dry burn" your heater outdoors on a day that is completely calm and windless. If it's too windy outside you can consider a porch, breezeway or other room with all of the windows open to disperse the strong odor.

Step 1 With your fuel tank nearly empty, burn your heater (without refilling) until the flame starts to burn out then raise the wick to its highest possible setting and leave it there until it burns out completely. Wait 60 minutes, then re-light the wick (with a match if necessary) and allow it to burn out again. Once the heater is cool to the touch, remove the cabinet and brush the top of the wick with an old tooth brush or other stiff bristle brush to remove any remaining ash. A canister type vacuum cleaner may be a useful tool in removing this ash.

Step 2 The first step should remove most carbon and your wick should feel softer to the touch. If any part still feels hard, you can use small pliers to pinch these hard spots and break up the carbon into pieces. After doing this, replace the cabinet, add a small amount of fuel, wait at least one hour and then repeat step 1.

Carry out Carbon Removal / Dry Burning within (7) seven days after your first use of your new heater to reduce carbon build-up on the wick's burning surface, after every two tankfuls of fuel and/or every week during the heating season. Afterwards, dry burn your heater anytime the wick appears to be hard. **CHECK YOUR WICK OFTEN!** Dry burn your wick and remove all fuel from your heater at the end of the heating season.

Note: Burn your heater dry, as noted above, weekly during the heating season or necessary thereafter. Check your wick often to see if CARBON REMOVAL / DRY BURNING is necessary. Carbon removal will NOT be effective if your fuel has been contaminated by water or any other liquid. In this case you must clean the fuel tank, replace the wick and soak it for 60 MINUTES in fresh, K-1 Kerosene.

**NEVER LEAVE THE HEATER
UNATTENDED WHILE BURNING!**

11 WICK ASSEMBLY- Check at least once a month!!

The burner assembly sits on top of the wick guide. Over time, tar deposits can accumulate on the wick guide, and this can prevent the burner assembly from seating properly. This can result in poor combustion, smoke, odor, etc.. To prevent this from happening, tar deposits on the wick guide can be removed as follows:

- Making sure that the heater is both cool and turned off, lower the wick to the "off" position.
- Remove the batteries (located at the rear of the heater).
- Remove the 2 guard bracket by removing 4 screws and lift off the grill assembly as shown in illustration. (Fig. A)
- Remove burner chamber.
- Using the wick adjuster knob, raise the top of the wick until it is even with the top of the wick guide. Using a flat-edge screwdriver, scrape off the tar deposits. Be careful not to allow any of the tar deposits to drop into the grooves of the wick guide. A small vacuum cleaner can be used to remove the tar deposits that have been scraped off (Fig.B).
- Reassemble the heater and replace the batteries.

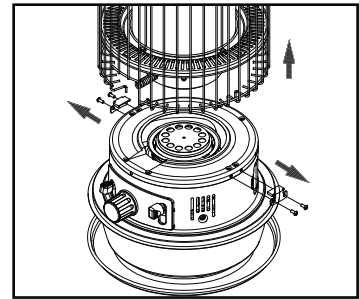

Fig.A

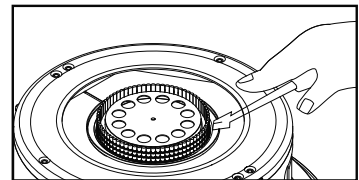

Fig.B

12 WICK REPLACEMENT

The wick in your heater needs replacing if, after repeated cleanings, any of the following conditions still exist: slow to light, hard movement of the wick adjuster knob, kerosene odor while burning, low heat output, slow warm up, damaged wick.

Use only a genuine replacement wick.

REPLACEMENT WICK NUMBER : Dura Heat : DH-249, Pick-A-Wick : PW-79, Kero World : 20430

If cleaning the Wick does not improve performance, you will need to replace the Wick Refer to the "TROUBLE SHOOTING GUIDE", see page 14. which outlines conditions under which the Wick should be replaced.

CAUTION : Use ONLY a genuine Replacement Wick. DO NOT attempt to substitute any other type of Wick device or a Wick designed for another brand or model heater You could damage the heater and create a potential fire hazard.

Call customer service at 814-643-1775, to order wick.

Visit our website at www.worldmktng.com for a link to detailed wick replacing directions.

ATTENTION : The only tools needed to replace the Wick are :

- A Pair of Pliers
- A Cross Screwdriver
- A Plastic Bag with a Twist Tie

1. Push down the manual shut-off Knob and turn the Wick Adjustment Knob **COUNTERCLOCKWISE** in the direction of "OFF".

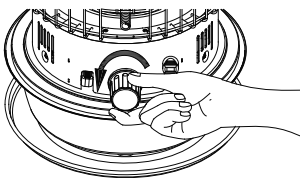

2. Use screwdriver to loosen and remove 3 screws that fix cabinet base to fuel tank. Remove the Wick-Adjuster Knob and Ignition Knob.

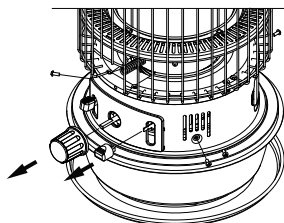

3. Tilt slightly and lift up the Cabinet & Grill assembly using both hands and lift away from the heater.

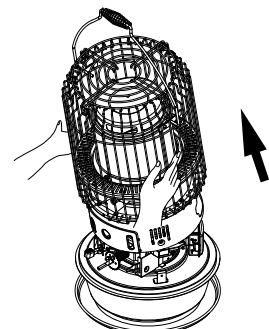

NEVER LEAVE THE HEATER UNATTENDED WHILE BURNING!

4. Remove 4 wing nuts with flat blade screw driver.

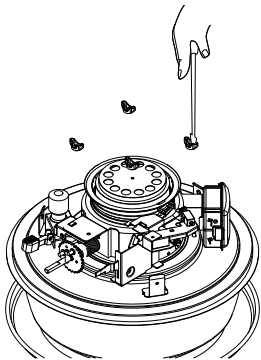

5. Lift the wick adjuster assembly straight up and away from the heater.

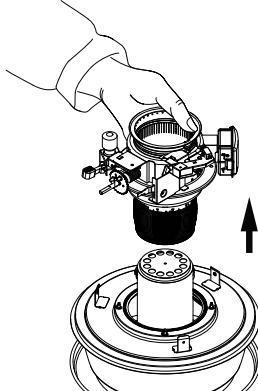

6. Hold the wick assembly up-side-down, using caution, grasp the wick cover firmly PULL it off with a sharp tug. If you have difficulty doing so, try loosening the wick cover with a flat blade screwdriver. CAUTION : The inside of wick cover has sharp teeth. The use of work gloves is suggested to avoid injury.

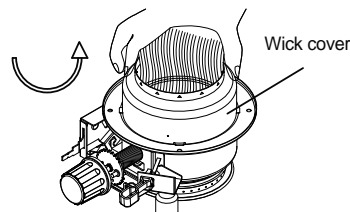

7. Remove the wick by folding it to the inside. Then remove the wick sleeve from the bottom of the assembly

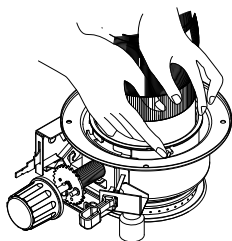

8. Install the new wick and insert the 3 pins on a new wick into the 3 holes on the wick sleeve in the upward direction. (See the arrow marked "up" on the wick sleeve)

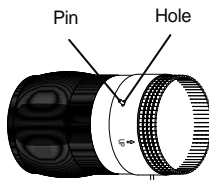

9. Push the new wick into the retainer teeth of the wick sleeve so that the wick adheres tightly around the inside of the wick sleeve, smoothing out any wrinkles.

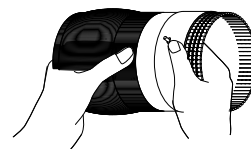

10. Line up the pins with the slotted holes inside the wick adjuster. Then lightly press each of the three pins of the wick (now attached to the wick sleeve) toward the center, away from the slanted grooves of the wick adjuster allowing the wick to drop slightly. Once the pins line up with each hole, press firmly on each pin toward the slanted grooves securely through each hole.

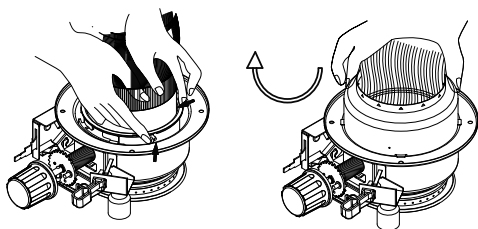

11. 1) Turn the wick adjustment knob to the fully raised position.
2) Pull lightly on the skirt of the wick to remove any slack.
3) Press lightly to secure the skirt to the retaining and remove any slack.
4) You will need to hold the knob to keep the wick at the highest position.

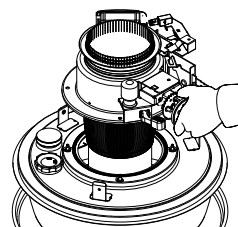

**NEVER LEAVE THE HEATER
UNATTENDED WHILE BURNING!**

- 12.** Snug 4 wing nuts on the mounting stud, but do not tighten.

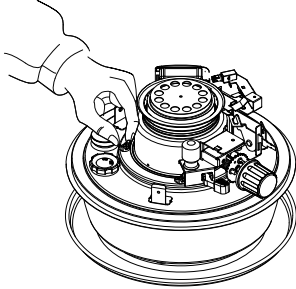

- 13.** Raise the wick to the full "up" position, and evenly tighten wing nuts in several steps.

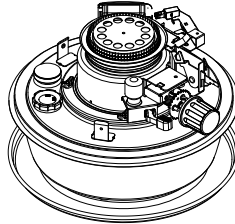

- 14.** Check height of wick. It should be 5/16" above collar.

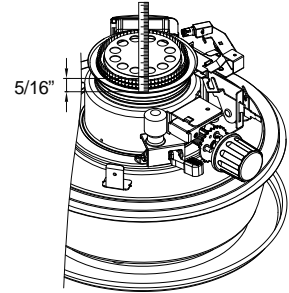

- 15.** Check for correct clearance between wick holder and draft tube. It should be the same all around.

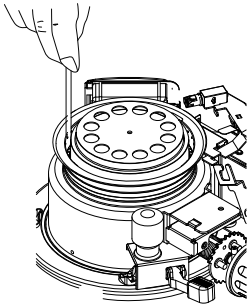

- 16.** Check the function of safety shut-off mechanism by pushing the extinguish button to upset the pendulum.

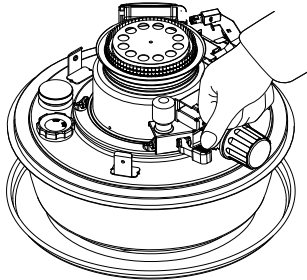

- 17.** Tilt the Cabinet & Grill assembly slightly using both hand and replace on heater from front to rear.

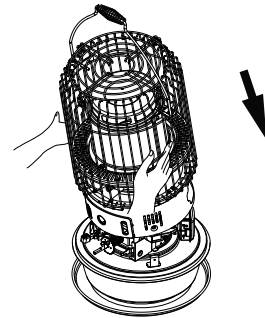

- 18.** Fasten the Cabinet & Grill assembly to the heater with 3 screws. Replace the Wick-Adjuster Knob and ignition Knob to the heater.

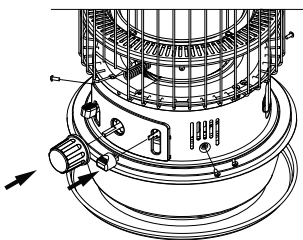

13 EXTINGUISHING THE HEATER

To extinguish the heater, push down on the manual shut-off knob(Fig.18) with one hand while holding the wick adjuster knob in the other hand. You will feel the pressure of spring action attempting to turn the wick adjuster knob in a counter-clockwise direction in your hand. By slowly relaxing your grip on the wick adjuster knob, you will allow the spring to gradually lower the wick and extinguish the flame. When there is no further pressure from the spring action, confirm that the wick has been fully lowered by turning the wick adjuster knob in a counter-clockwise direction as far as it will go. After 10-15 seconds, open the door on the body of the heater, lift the burner using the burner knob, and visually confirm that there are no flames present. This will confirm that the heater is completely extinguished.

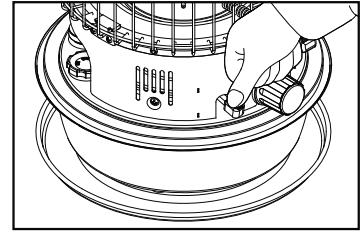

Fig. 18

CAUTION : After extinguishing the heater, **allow at least 10 minutes before reigniting the heater.** This allows the heater time to cool off and return to a normal temperature. Failure to allow the 10 minute cooling off period before reigniting the heater will result in the creation of a strong odor and possible flare-up.

WARNING : Carbon and tar can build up on the wick after the heater has been in use for a while. This can interfere with the ability of the wick to be lowered into the body of heater, and can result in the flame not extinguishing completely. It is the responsibility of the owner to inspect the wick, to maintain proper maintenance of the wick, and to replace the wick when necessary in order to prevent the build up of carbon and tar from creating a dangerous situation where the heater does not fully extinguish.

14 AUTOMATIC SAFETY SHUT-OFF DEVICE

This heater is equipped with an automatic safety shut-off device. The purpose of this device is to quickly and efficiently shut-off the heater should the heater be jarred or tipped over while in operation. This is the main safety system that is built into the heater, and it functions to prevent the flame from spreading if the heater is knocked over.

The automatic safety shut-off device is built into the mechanism that raises and lowers the wick. It has been designed so that if the pendulum is jarred by a shock of some sort, it retracts a latch from the wick control shaft ratchet, and a torsion spring reacts to drop the wick to its fully lowered position. This rapid lowering of the wick extinguishes the flame.

If you find that the wick will not raise, push the manual shut-off knob (see diagram on P.2) to engage the automatic safety shut-off device. Then dial the wick up via the wick adjuster knob.

IMPORTANT NOTICE : For the safety shut-off device to function properly, the wick must be free of carbon and tar deposits. Regularly performing the "Carbon Removal / Dry burning" procedure described in the "Wick Maintenance" and "Carbon Removal / Dry Burning" sections on page 13 is very important to the proper functioning of this important safety device.

IMPORTANT NOTICE : PLEASE CHECK THE SAFETY SHUT-OFF DEVICE ONCE A WEEK DURING THE HEATING SEASON TO INSURE THAT IT IS FUNCTIONING PROPERLY.

IMPORTANT NOTICE : EVERY TIME THE WICK IS REMOVED OR REPLACED, THE SAFETY SHUT-OFF DEVICE MUST BE TESTED TO INSURE THAT IT IS FUNCTIONING PROPERLY.

**NEVER LEAVE THE HEATER
UNATTENDED WHILE BURNING!**

TESTING THE SAFETY SHUT-OFF DEVICE : At least once a week during the heating season, it is important to test the safety shut-off device to be sure that it is operating properly. **WITH THE HEATER TURNED OFF**, raise the wick using the wick adjuster knob to the fully raised position. Grabbing the protective grille, give the heater a firm shake. If the safety shut-off device is working properly, you will hear a loud noise as the ratchet is disengaged and the torsion spring drops the wick into the body of the heater. To verify that the wick has been completely lowered, turn the wick adjuster knob in a counterclockwise direction. If the safety shut-off device is functioning properly, the wick will have been completely lowered. If you are able to lower the wick further using the wick adjuster knob, this means that it is time to perform the "Carbon Removal Dry Burning" procedure described on page 13 again.

15 LONG TERM STORAGE OF YOUR HEATER

Carefully following the instructions for storage given below will insure that your heater will operate efficiently and safely next season (Fig.19/ Fig.20).

- Using a small amount of kerosene, swirl and rinse the inside of the tank. **NEVER mix water with the kerosene** as it will cause rust inside the tank. Pour the kerosene out making sure that you remove it all.
- With the fuel tank empty, ignite the heater. With the wick at its maximum height, keep the wick burning until it burns out completely (about 1 hour). It is a good idea to do this outside or in an extremely well- ventilated area.
- Remove the batteries. Remove the 2 cabinet screws and lift off the the cabinet and grille assembly. Remove the burner. Remove the wick adjuster from the fuel reservoir. Thoroughly dry the inside of the fuel tank. Using a screwdriver and/or a brush, remove any carbon, tar or soot that might have accumulated on the wick adjuster, wick guide or burner.
- After a thorough cleaning, reassemble the heater. It is important when reassembling the wick adjuster to be sure to maintain an equal gap between the wick adjuster and the wick guide cylinder all around. See "Wick Replacement" on page 14 for reference.
- Remove the batteries from the battery case before storing the heater to prevent leakage and corrosion.
- Store the heater with the wick in the fully lowered position and the safety shut-off device deactivated.
- Store the heater in the original box with the original packing material and keep the **OWNER'S MANUAL** with the heater. Store in an area that is well- ventilated.

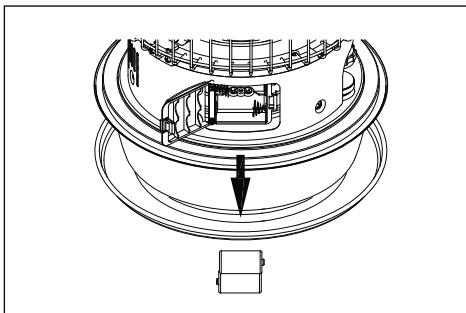

Fig. 19

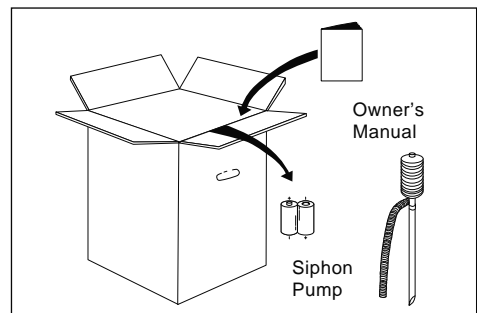

Fig. 20

16 TROUBLE SHOOTING GUIDE

TROUBLE	CORRECTIVE ACTION
<p><u>Heater Will Not Light ;</u></p> <ol style="list-style-type: none"> 1. Fuel tank is empty 2. Water present in kerosene 3. Igniter plug fails to glow 4. Igniter plug makes contact with side of wick 	<ol style="list-style-type: none"> 1. Fill tank with 1-K kerosene. 2. Drain tank. Remove wick assembly & replace wick. Reinstall wick assembly. Fill tank with 1-K kerosene. 3. Replace batteries. Replace igniter plug. Check for broken or disconnected wire. 4. Lower wick using wick adjuster knob until igniter plug makes contact with top of wick.
<p><u>Heater Produces Smoke or Odor ;</u></p> <ol style="list-style-type: none"> 1. Flame is too high 2. Heater is in an air draft 3. Burner is not level 4. Carbon or tar built up on wick 5. Contaminated kerosene 	<ol style="list-style-type: none"> 1. Using wick adjuster knob, lower wick to desired 1/2" flame. 2. Move heater out of air draft. 3. Using burner knob, rotate burner from side to side until it seats properly over wick. 4. Perform "Carbon Removal / Dry Burning" procedure. Replace wick if necessary. 5. Drain tank. Remove wick assembly & replace wick. Reinstall wick assembly. Fill tank with 1-K kerosene.
<p><u>Flame Flickers or Dies ;</u></p> <ol style="list-style-type: none"> 1. Water present in kerosene 2. Carbon or tar built up on wick 	<ol style="list-style-type: none"> 1. Drain tank. Remove wick assembly & replace wick. Reinstall wick assembly. Fill tank with 1-K kerosene. 2. Perform "Carbon Removal / Dry Burning" procedure. Replace wick if necessary.
<p><u>Wick Burning Down Excessively ;</u></p> <ol style="list-style-type: none"> 1. Dangerous, volatile fuel mixed with kerosene (gasoline, benzene, alcohol, white gas, paint thinner, camp, stove fuel, oil compound) 	<ol style="list-style-type: none"> 1. Drain and clean tank <ul style="list-style-type: none"> - Remove and replace wick - Fill tank with -K kerosene.
<p><u>Wick Adjuster Sticks ;</u></p> <ol style="list-style-type: none"> 1. Water present in kerosene 2. Carbon or tar built up 	<ol style="list-style-type: none"> 1. Drain tank. Remove wick assembly & replace wick. Reinstall wick assembly. Fill tank with 1-K kerosene. 2. Perform "Carbon Removal / Dry Burning" procedure. Replace wick if necessary.
<p><u>Wick will not raise ;</u></p>	<ul style="list-style-type: none"> - Push the safety reset lever (see diagram on P.2) to engage the automatic safety shut-off device. Then dial the wick up via the wick adjuster knob.
<p><u>Heater is enveloped in flames ;</u></p>	<ul style="list-style-type: none"> - Call Fire Department. - Smother flames with fire extinguisher or sand. Otherwise smother flames with blankets and then throw water on blankets. Do not throw water directly on the heater itself.

**NEVER LEAVE THE HEATER
UNATTENDED WHILE BURNING!**

17 PARTS LIST

DRAWING NUMBER	DESCRIPTION	PART NUMBER
1	TANK ASS'Y	2111-0066-01
2	GASKET-TANK	3321-0035-00
3	FUEL-INDICATOR ASS'Y	2112-0017-00
4	FILL CAP ASS'Y	2121-0007-00
5	WICK CASE ASS'Y	2113-0028-00
6	SAFETY SHUT-OFF ASS'Y	2116-0005-00
7	IGNITION ASS'Y	2117-0011-00
8	BATTERY CASE ASS'Y	2118-0031-00
9	WICK ADJUSTER KNOB	2117-0009-00
10	KNOB IGNITION	3231-0150-00
11	WICK HOLDER	3121-0508-00
12	WICK	See Specs Below
13	CABINET BASE	3111-0291-00
14	PANEL-NAME PLATE	3121-0509-02
15	CABINET BASE TOP	3111-0292-00
16	BURNER ASS'Y	2112-0043-00
17	MIDDLE PLATE	3111-0293-01
18	GRILLE - GLASS FIX	3561-0073-00
19	GLASS - CYLINDER	3631-0021-00
20	TOP PLATE	3111-0295-01
21	GRILLE FRONT	2114-0021-01
22	GRILLE REAR	2114-0022-01
23	TOP GRILL	2114-0023-01
24	HANDLE HANGER	3561-0074-01
25	DRIP TRAY	3111-0245-00

18 EXPLODED PARTS DRAWING

NOTE : SPECIFY MODEL NUMBER AND PART NUMBER WHEN ORDERING PARTS.

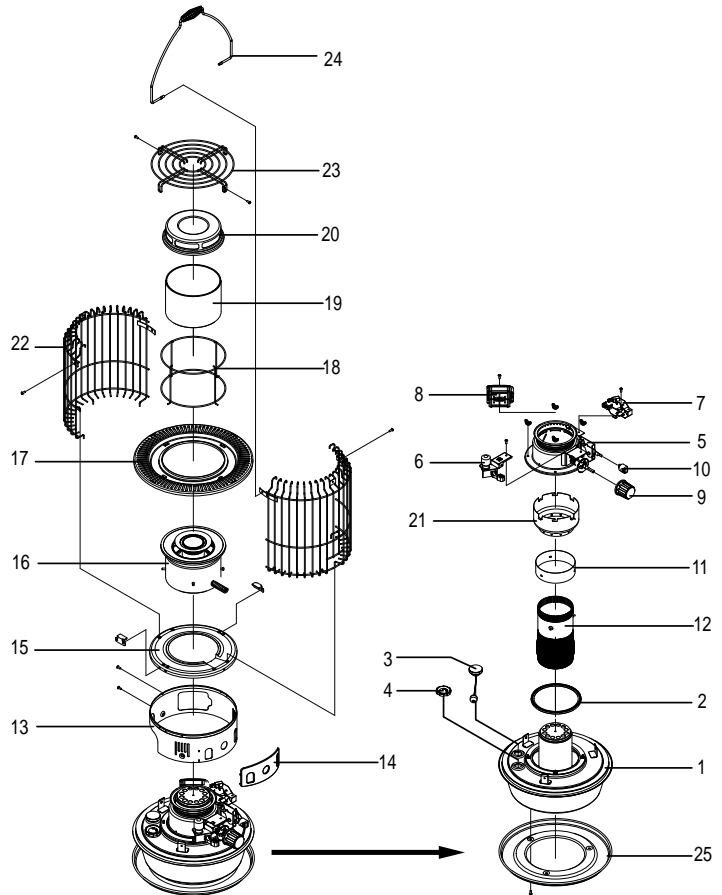

19 SPECIFICATIONS

Model No.	KW-12	
Type of Heater	Convection	
Heat Output	Max. 10,500 BTU/hr	
Fuel Tank	Integral	
Tank Capacity	1.1 U.S. gallons	
Continuous Combustion Time	Approx. 12~15 hr	
Max. Fuel Consumption	0.079 U.S. gallons/hr.	
Ignition Method	Battery-C Cell x2, Igniter Type "B"	
Weight(empty)	Approx. 14 lbs	
Dimensions	Height	21.3 inches
	Width	12.6 inches
	Depth	12.6 inches
Wick Height	5/16 IN. (8mm)	
Replacement Wick Number	Dura Heat : DH-249, Pick-A-Wick : PW-79, Kero World : 20430	