

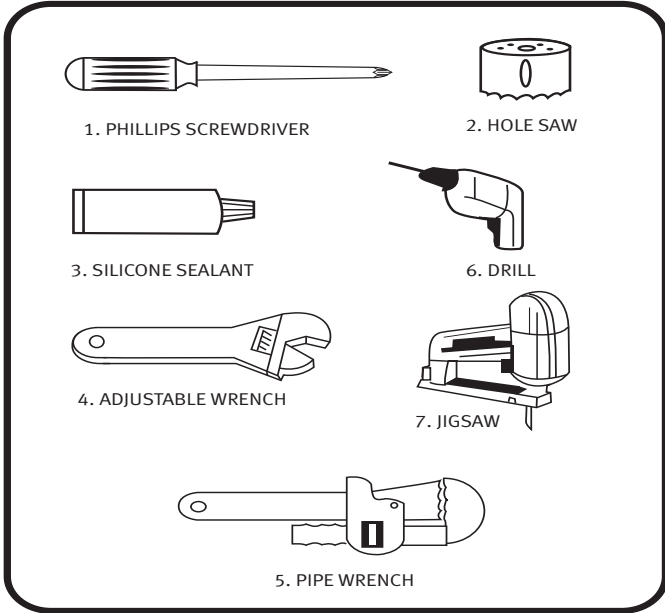

Tectonite Topmount Installation & Care Instructions



CONGRATULATIONS!

You have purchased a quality product designed for long lasting beauty and easy installation. The following instructions will take you step-by-step through the installation process and care of your product. We recommend reading the entire instruction booklet before beginning.

TOOLS AND MATERIALS

1. Long phillips head screwdriver
2. 2" Hole saw if you are installing a new countertop
3. Tube of silicone sealant for mounting the faucet, strainers and sink
4. Adjustable wrench
5. Pipe wrench if steel pipe is used
6. Drill
7. Jigsaw

BUYER PROTECTION LIMITED WARRANTY

SINKS

Franke Consumer Products, Inc. warrants its sinks to be free of manufacturing defects in material and workmanship under normal residential usage for the lifetime of the sink.

AUTHORIZED RESELLERS

Warranties are not applicable to products sold by unauthorized resellers. The consumer accepts responsibility to research the integrity and reputation of the reseller to ensure they are authorized to sell and provide appropriate pre purchase and post purchase service. Internet resellers should be particularly scrutinized as they are very difficult to evaluate and often provide very limited or no customer service.

GENERAL

This warranty applies only to the original owner, providing the product has been installed in accordance with our installation instructions, used as recommended and in a normal residential application. In the event of a warranty claim, the owner will be required to provide proof of purchase, a sales receipt.

This warranty covers all components which make the product operational. Franke Consumer Products, Inc., at its option, may repair or replace the product or components necessary to restore the product to good working condition. Franke reserves the right to inspect the installation prior to the actual replacement of the product or component part.

This warranty does not cover misuse or abuse, accidental damages, scuffs or scratches, improper installation, abnormal usage, negligence or damage caused by improper maintenance or cleaning. Normal wear of parts is excluded from the warranty. Damage caused by impurities or acts beyond our control are not covered. **Any product or part which has been repaired or altered in any manner outside of Franke's factory, unless previously authorized in writing by Franke, will void warranty. Any replacement excludes transportation and any labor re-installation costs.** This warranty does not allow recovery of incidental or consequential damages such as loss of use, delay, property damage or other consequential damage, and Franke accepts no liability for such damages.

The Franke warranty is limited to the above conditions and to the warranty period specified herein and is exclusive. Franke DISCLAIMS all other warranties, expressed or implied, including IMPLIED WARRANTIES OF MERCHANTABILITY AND/OR FITNESS FOR AS PARTICULAR PURPOSE. This warranty gives you specific legal rights that may vary from state to state.

WARRANTY:

Limited Lifetime Warranty

For additional products and accessories, please visit our website or call our customer service at 1.800.637.6485

www.frankeusa.com



Step 1

REMOVING EXISTING SINK

1. Leave the faucet and drain outlet in place.
2. Shut off water supply valves. (Usually under sink)
3. Relieve pressure by opening hot and cold faucet valves. Let water run until it stops flowing.
4. Disconnect the supply lines from the water supply valves.
5. Disconnect the drain fitting from the waste trap.
6. Remove frame or rim fasteners around underside of old sink.
7. Lift sink out with faucet and drain fitting still in place.

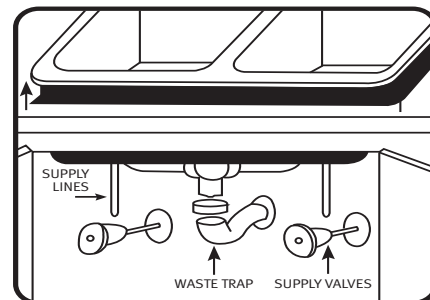

Step 2

PREPARING AN EXISTING COUNTERTOP

1. Make sure existing countertop cutout opening is the proper size. Set the new sink into opening. The sink rim should rest evenly on the countertop. (Slight adjustments can be made using a file or a saber saw)
2. Use caution not to chip or crack the counter top when filing or sawing.
3. After final fitting, remove the new sink from cut-out.
4. For new countertop instructions see the following instructions.

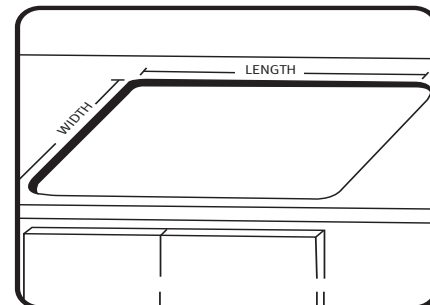

PREPARING A NEW COUNTERTOP USING THE SINK AS A TEMPLATE

1. Carefully place the sink upside down on the countertop at the desired position. Trace the sink outline on the countertop. (Do not cut along this line)
2. Draw a line $\frac{3}{8}$ " inside the sink outline. Measure the cut-out line you just drew and compare to all sink dimensions. The cut-out line should be approximately $\frac{3}{4}$ " smaller than the overall sink dimensions.
3. Double check both measurements.
4. Drill a pilot hole inside the cutting line.
5. Using a jigsaw, cut along the inside line to cut the opening in the countertop.

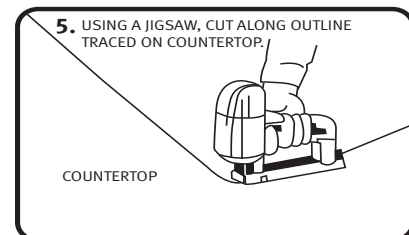
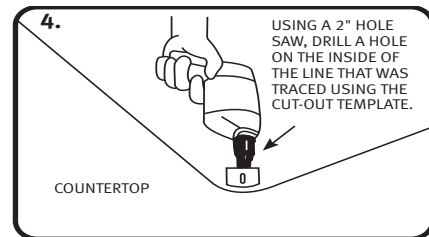
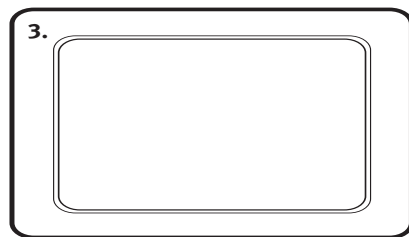
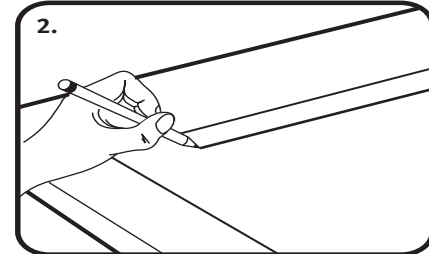
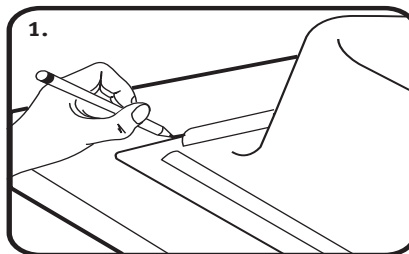

PREPARING A NEW COUNTERTOP USING THE CUT-OUT TEMPLATE PROVIDED

(Included in or on the carton)

1. If template is located on the outside of the carton cut along dotted line.
2. If template is not located on the outside of the carton use template provided in the carton. Measure the cutout line and compare to all sink dimensions. The cutout line should be $\frac{3}{4}$ " smaller than overall sink dimension.
3. Trace on the countertop completely around the edge of the template.
4. Drill a pilot hole inside the cutting line.
5. Using a jigsaw, cut along the inside line to cut the opening in the countertop.

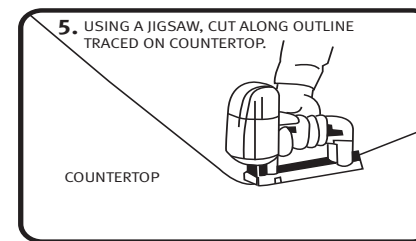
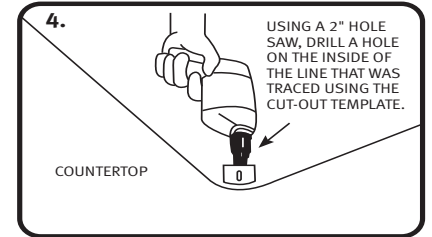
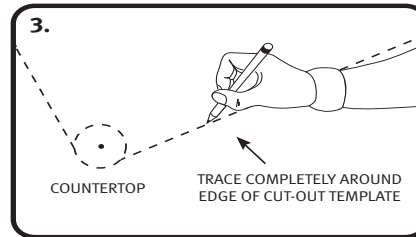
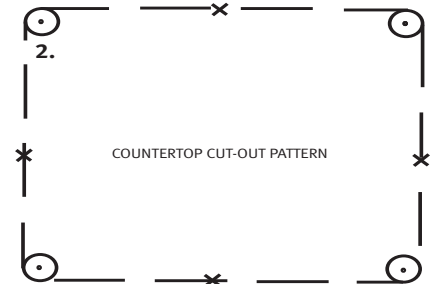
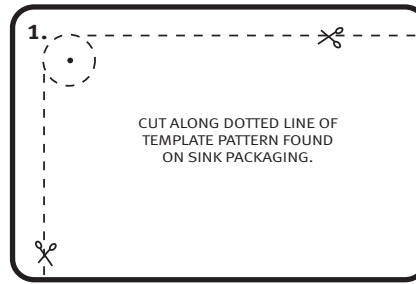

Step 3

INSTALLING ACCESSORIES

Now is the time to attach your faucet and drains to your new sink. Use plumber's putty or silicone sealant under the faucet base and under the top flange of the drain to provide a leak proof seal.

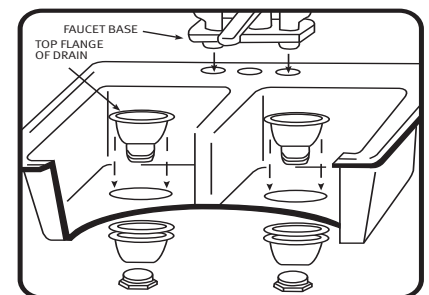

Step 4

INSERTING SINK AND TIGHTENING MOUNTING CLIPS

1. With sink in the upside down position, place a continuous and generous bead of silicone sealant around the entire perimeter of the rim. This serves as a watertight seal.
2. Lift sink, turn face up, and lower into the countertop cutout opening.
3. Line up front rim with the front edge of the counter.
4. The clip is adjustable to countertop thickness by flipping the clip over to provide a tight seal.
5. Underneath the countertop begin tightening clips with a screwdriver in an even fashion, alternating sides while tightening, until the entire rim is sealed.
6. Do not over tighten. It is only necessary to draw the rim down snugly to the countertop.
7. Wipe excess sealant from perimeter with a wet cloth.

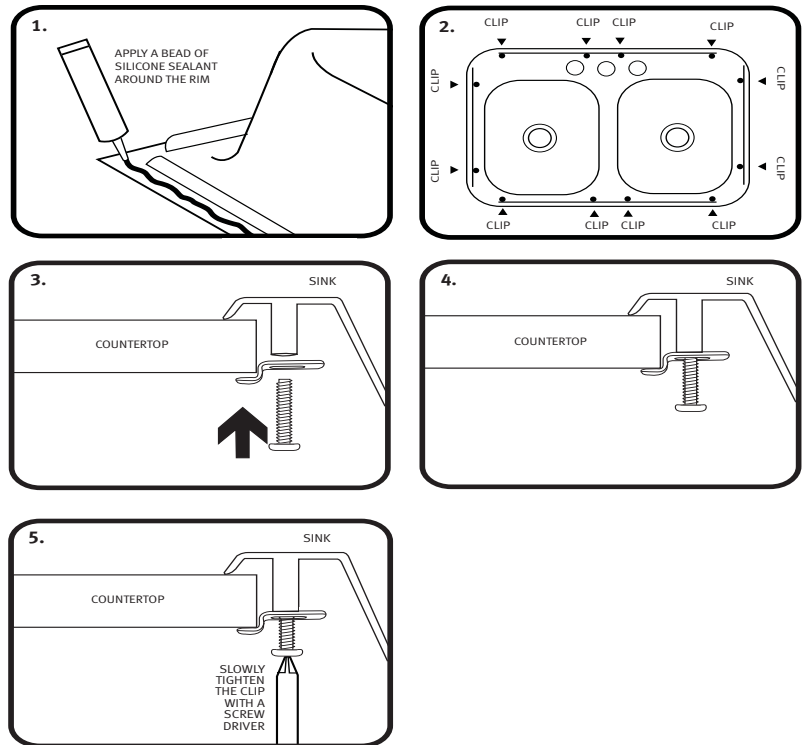

Step 5

FINISHING

1. Re-connect and tighten hot and cold faucet supply lines, strainer, drain, and trap assembly.
NOTE: Depending on the location of sink drain holes it may be necessary to adjust the drain pipe fittings under the sink to accommodate the new sink installation.
2. Turn on water supply, check all connections for leaks. If leak appears, tighten joint slightly. Do not over tighten.
3. With stopper in place fill sink and check for leaks under sink and around drain flange.
4. Remove stopper and let water drain while checking drain connections.

CARE INSTRUCTIONS

To insure long-lasting beauty the best preventative maintenance is to ensure that the sink is clean, dry and exposed to room atmosphere when not in use. Rinse and towel dry to keep it relatively free of water spots, especially if you have hard water.

To clean your sink, use the mildest procedure that will do the job, generally liquid detergent and water. Rinse and dry.

STAINS. To avoid hard water spots wipe sink dry with clean soft towel after use.

CAUTION. Steel wool pads leave tiny particles that may cause rust spots. Rubber mats are acceptable if removed after each use.



CÓMO INSERTAR EL FREGADERO Y APRETAR LAS GRAPS DE INSTALACIÓN

1. Con el fregadero boca abajo, coloque una línea continua y abundante del sellador de silicona a lo largo de todo el perímetro del borde. Esto logrará un sello impermeable.
2. Levante el fregadero, póngalo boca arriba y déjelo deslizar dentro de la abertura recortada en la cubierta.
3. Alinee el reborde frontal con el borde frontal de la cubierta.
4. La grapa se puede ajustar al grueso de la cubierta del mostrador dando vuelta a la grapa para lograr un sello hermético.
5. Comience a atornillar las grapas debajo de la cubierta del mostrador en forma uniforme con un destornillador, alternando de lado mientras se aprietan, hasta que se selle todo el borde.
6. No apriete demasiado. Sólo es necesario que el reborde se acomode bien sobre la cubierta.
7. Usando un trapo húmedo limpie el sobrante de sellador por todo el perímetro.

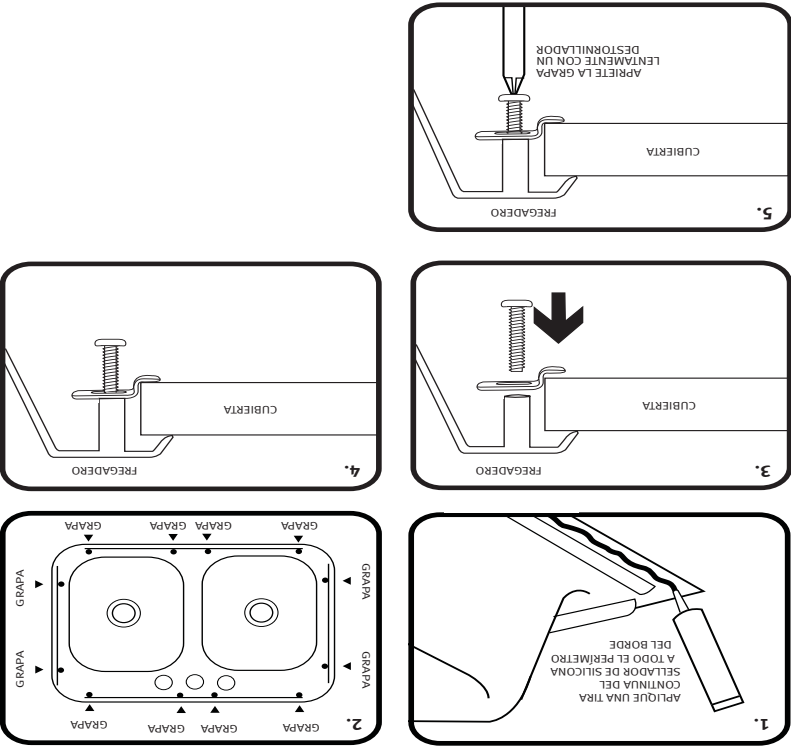

Paso 5

PARA TERMINAR

1. Vuelva a conectar y apretar las líneas de suministro de agua caliente y fría al grifo, el cedazo, drenaje y el ensamble de la trampa de desechos. NOTA: Según la ubicación de los orificios de drenaje del fregadero podrá ser necesario ajustar los accesorios de la tubería del drenaje debajo del fregadero para ajustarse a la instalación del fregadero nuevo.
2. Abra el suministro de agua y verifique que no haya fugas en ninguna de las conexiones. Si apareciera una fuga, apriete un poco más la conexión. Pero no apriete demasiado.
3. Con el tapón en su sitio, llene el fregadero y verifique que no haya fugas debajo del fregadero y alrededor del reborde del drenaje.
4. Quite el tapón y deje desaguar, siempre verificando que no haya fugas en las conexiones del drenaje.

INSTRUCCIONES DE CUIDADO

El mejor mantenimiento preventivo para asegurar una belleza duradera es conservar el fregadero limpio y seco, y expuesto a temperatura de ambiente cuando se usa. Enjuague y limpie con una toalla para conservarlo libre de manchas de agua, particularmente si tiene agua dura.

Use el procedimiento más suave posible para limpiar su fregadero, usualmente un detergente líquido y agua. Enjuague y seque.

MANCHAS. Para evitar las manchas de agua dura seque el fregadero con una toalla suave y limpie luego de utilizarlo.

PRECAUCIÓN. Las almohadillas de lana de acero pueden ocasionar manchas de oxidación. Se puede utilizar tapetes de hule, siempre y cuando los quite después de usarlos cada vez.



CÓMO PREPARAR UNA CUBIERTA NUEVA COMO USAR LA PLANTILLA DE RECORTE

PROVISTA

(Viene impresa en el cartón de empaque o se incluye en el interior del mismo)

1. Si la plantilla viene impresa en el cartón, recórtela siguiendo la línea punteada.
2. Si la plantilla no viene colocada en el lado exterior del empaque, utilice la plantilla que se incluye dentro del empaque. Mida la línea de corte y compare con todas las dimensiones del fregadero. La línea de corte deberá ser 1/2" más pequeña que la dimensión total del fregadero.
3. Trace todo el contorno de la plantilla de la cubierta.
4. Taladre un orificio piloto por la parte interna de la línea de recorte.
5. Con la sierra de vaivén, recorra a todo lo largo la línea interna para recortar la abertura de la cubierta.

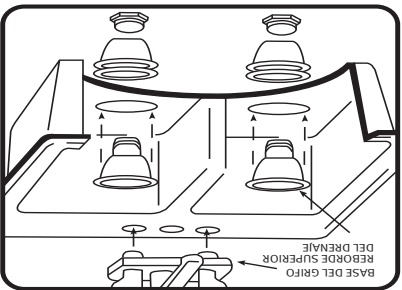
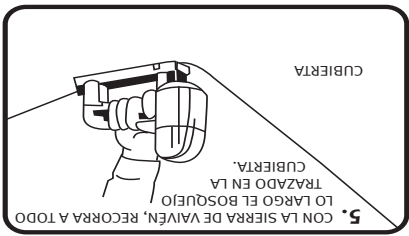
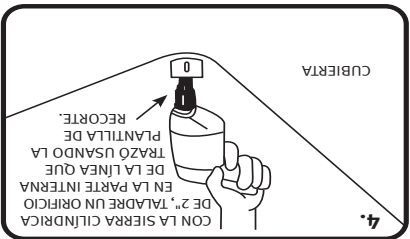
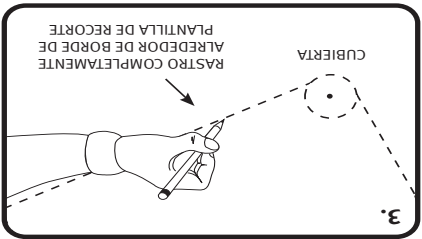
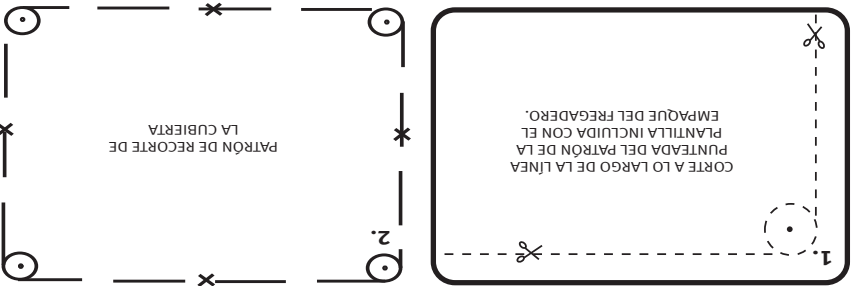

CÓMO INSTALAR LOS ACCESORIOS

Ahora es el momento de colocar sus nuevos grifos y drenajes en su nuevo fregadero. Utilice masilla de plomero o sellador de silicona debajo de la base del grifo y debajo del reborde superior del drenaje para lograr un sello a prueba de fugas.

Paso 3

Paso 1

CÓMO QUITAR EL FREGADERO EXISTENTE

1. Deje en su sitio el grifo y la salida del drenaje.
2. Cierre las válvulas de corte del suministro de agua. (Normalmente se encuentran debajo de fregadero.)
3. Libere la presión dejando abiertas las válvulas del agua fría y caliente. Deje correr el agua hasta que acabe de fluir.
4. Desconecte las líneas de alimentación de las válvulas de suministro de agua.
5. Desconecte el accesorio del drenaje de la trampa de desechos.
6. Quite el marco o los sujetadores del borde que se encuentra alrededor de la parte inferior del fregadero antiguo.
7. Extraiga el fregadero con todo y el grifo y el accesorio de drenaje.

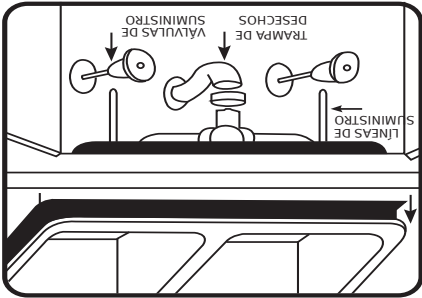

Paso 2

CÓMO PREPARAR UNA CUBIERTA EXISTENTE

1. Cerciórese de que la abertura recortada en la cubierta existente es del tamaño correcto. Deslice el fregadero nuevo por la abertura. El borde del fregadero deberá apoyarse uniformemente sobre la cubierta. (Se pueden hacer pequeños ajustes con una lima o una sierra de vaivén)
2. Tenga cuidado de no astillar o romper la cubierta si usa la lima o corta con la sierra.
3. Después del ajuste final, extraiga el nuevo fregadero de la abertura recortada.
4. Para las instrucciones de la cubierta nueva consulte las instrucciones siguientes.

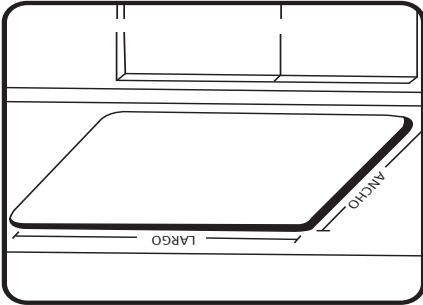

CÓMO PREPARAR UNA CUBIERTA NUEVA USE EL FREGADERO COMO PLANTILLA

1. Cuidadosamente coloque el fregadero boca abajo sobre la cubierta en la ubicación deseada. Trace el contorno del fregadero en la cubierta. (No corte a lo largo de este trazo)
2. Trace una línea a 3/8" (9.5 mm) dentro del contorno de la plantilla del fregadero. Mida la línea de corte que acaba de trazar y compare con todas las dimensiones del fregadero. La línea de corte debe ser cerca de 3/4" (19 mm) más pequeña que la dimensión total del fregadero.
3. Compruebe ambas mediciones dos veces.
4. Taladre un orificio piloto por la parte interna de la línea de recorte.
5. Con la sierra de vaivén recorra a todo lo largo la línea interna para recortar la abertura de la cubierta.

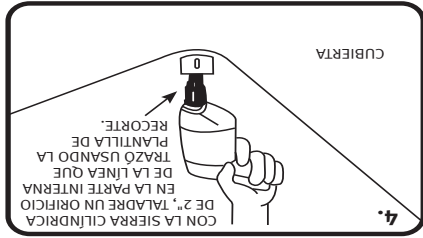
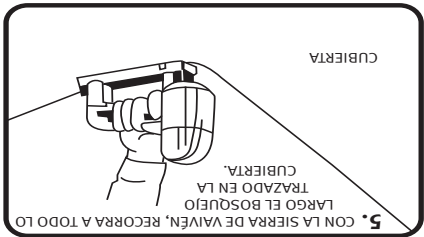
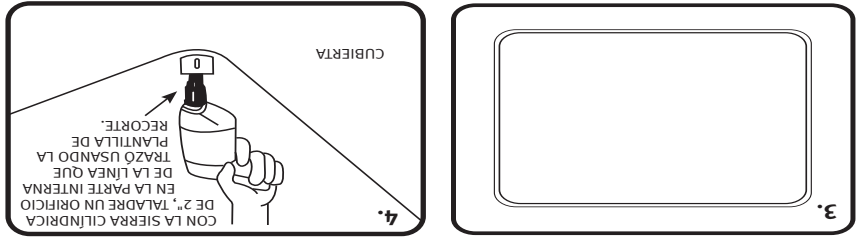
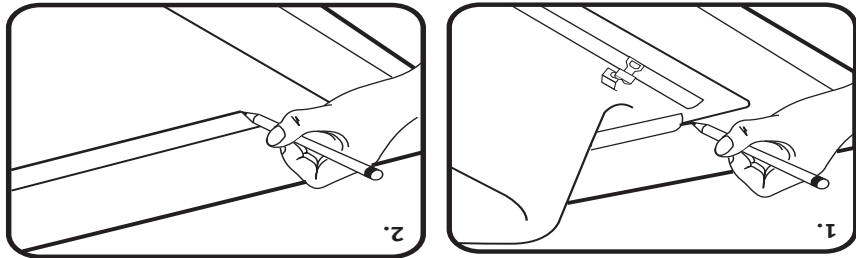



Instrucciones de instalación y cuidado de Tectonite Topmount

¡FELICITACIONES!

Ha comprado un producto de calidad y diseñado para brindar belleza duradera y muy fácil de instalar. Las instrucciones que aparecen a continuación le van a guiar paso a paso por el proceso de instalación y cuidado de su producto. Le sugerimos que lea todo el manual de instrucciones antes de seguir adelante.

HERRAMIENTAS Y MATERIALES

1. Destornillador largo de cabeza Phillips
2. Sierra cilíndrica de 2 pulg Si es que va a instalar una cubierta nueva
3. Tubo de sellador de silicona para instalar el grifo, coladeras y fregadero
4. Llave inglesa ajustable
5. Llave de tuercas para tubería si usa tubería de acero
6. Taladro
7. Sierra de vaivén
8. Guantes

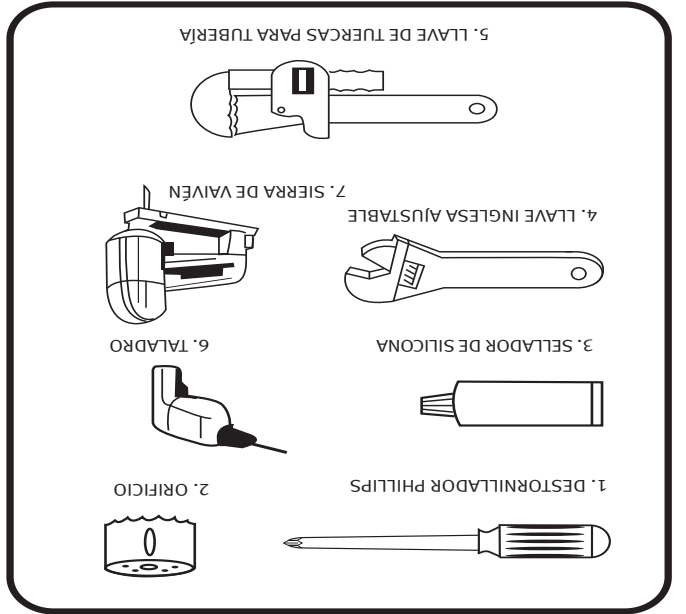

SINKS

Franke Consumer Products, Inc. warrants its sinks to be free of manufacturing defects in material and workmanship under normal residential usage for the lifetime of the sink.

AUTHORIZED RESELLERS

Warranties are not applicable to products sold by unauthorized resellers. The consumer accepts responsibility to research the integrity and reputation of the reseller to ensure they are authorized to sell and provide appropriate pre purchase and post purchase service. Internet resellers should be particularly scrutinized as they are very difficult to evaluate and often provide very limited or no customer service.

GENERAL

This warranty applies only to the original owner, providing the product has been installed in accordance with our installation instructions, used as recommended and in a normal residential application. In the event of a warranty claim, the owner will be required to provide proof of purchase, a sales receipt.

This warranty covers all components which make the product operational. Franke Consumer Products, Inc., at its option, may repair or replace the product or components necessary to restore the product to good working condition. Franke reserves the right to inspect the installation prior to the actual replacement of the product or component part.

www.frankeusa.com

For additional products and accessories, please visit our website or call our customer service at 1.800.637.6485

Limited Lifetime Warranty

WARRANTY:

The Franke warranty is limited to the above conditions and to the warranty period specified herein and is exclusive. Franke DISCLAIMS all other warranties, expressed or implied, including IMPLIED WARRANTIES OF MERCHANTABILITY AND/OR FITNESS FOR AS PARTICULAR PURPOSE. This warranty gives you specific legal rights that may vary from state to state.

WARRANTY:
The Franke warranty is limited to the above conditions and to the warranty period specified herein and is exclusive. Franke DISCLAIMS all other warranties, expressed or implied, including IMPLIED WARRANTIES OF MERCHANTABILITY AND/OR FITNESS FOR AS PARTICULAR PURPOSE. This warranty gives you specific legal rights that may vary from state to state.

This warranty does not cover misuse or abuse, accidental damages, scuffs or scratches, improper installation, abnormal usage, negligence or damage caused by improper maintenance or cleaning. Normal wear or parts is excluded from the warranty. Damage caused by impurities or acts beyond our control are not covered. **Any product or part which has been repaired or altered in any manner outside of Franke's factory, unless previously authorized in writing by Franke, will void warranty. Any replacement excludes transportation and any labor re-installation costs.** This warranty does not allow recovery of incidental or consequential damages such as loss of use, delay, property damage or other consequential damage, and Franke accepts no liability for such damages.

Need New UPC Code

