

ICS  **Cutting Tools, Inc.**

REVISED MAR 2023

THREADING TOOLS

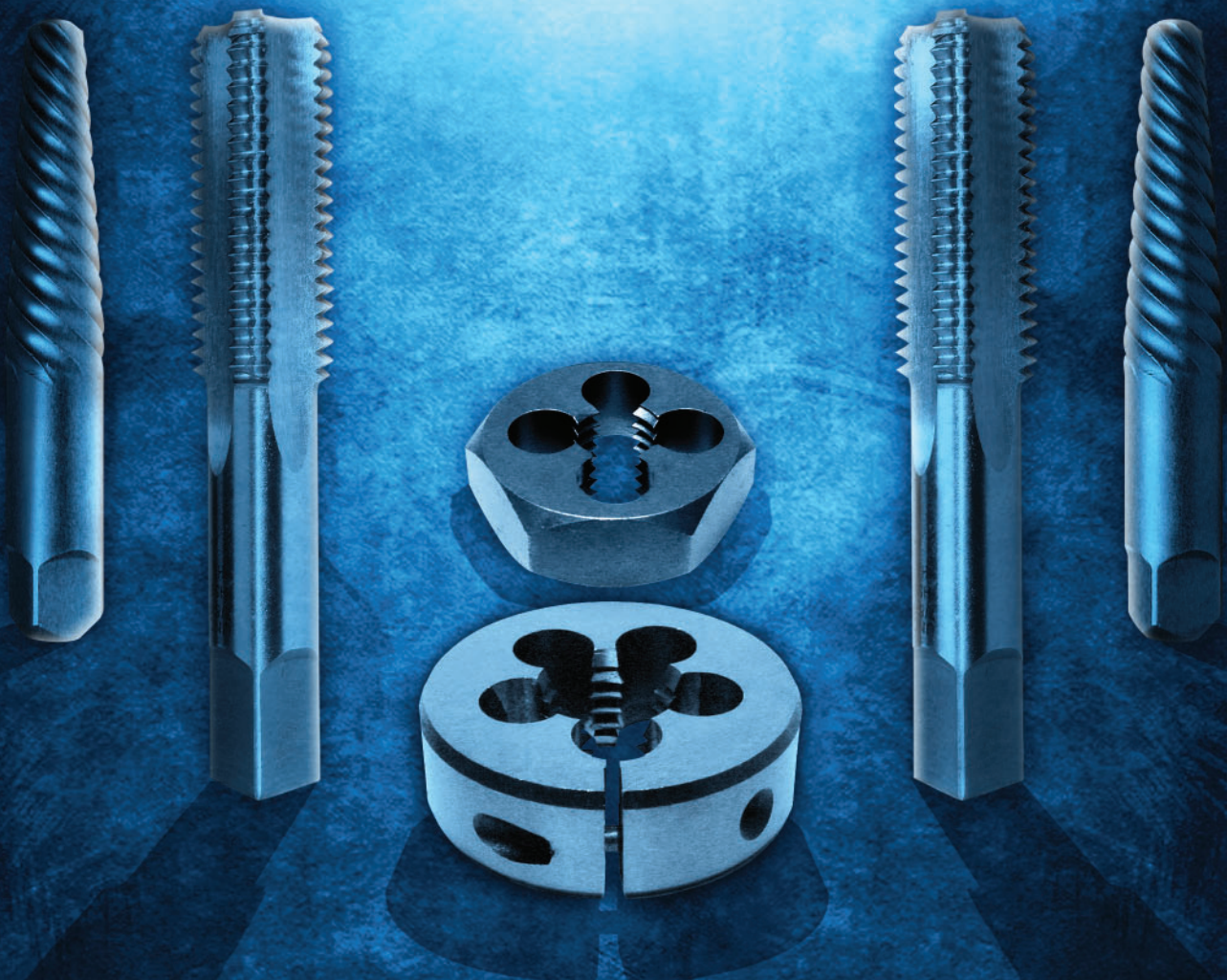

ICS CUTTING TOOLS, INC
511 Main Street • Casco, WI 54205-0125 USA
(920) 837-2526 • Fax (920) 837-2530
www.icscuttingtools.com • info@icscuttingtools.com

THREADING TOOLS

TAPS

Carbon Steel

Automotive Rethreading.....	31
Fractional	17
Machine Screw	17
Metric	17
Pipe	
Taper.....	37
Taper (British Standard)	37
Spark Plug Rethreading	31

Cobalt

Spiral Flute (CNC)	29
Spiral Point.....	22

High Speed Steel

Fractional	5
Left Hand	7
Left Hand - Metric	15
Special Thread.....	10-12
Machine Screw	5
Metric	13
Metric - Special Thread	
M1.4 to M19	14
M19 to M52	15

8 Pitch	8
10 Pitch (Sucker Rod).....	8
Automotive	62

British Standard Pipe	
Parallel (G or Rp).....	36
Taper (Rc)	36
Taper (Long).....	36
Metric	36

Coil Rod Thread	9
Lead Taps (Double, Triple & Quad).....	6
Nut Taps	28
Oversize +.005	7
Oversize - Special	7

Pipe	
Left Hand	36
Interrupted.....	35
Straight.....	35
Taper.....	35

Pulley.....	28
Spiral Point.....	27
Screw Thread Insert.....	19

Spiral Flute	
High Performance.....	26
Fast Spiral	29
Regular Spiral.....	29

Spiral Point	
Fractional.....	20
High Performance.....	26
High Performance - Long Length.....	26
Screw Thread Insert.....	19
Oversize +.005.....	22
Pulley	27
Metric	21

Spiral Point Extension Taps	22
Tandem "Acme" Thread Taps	33
Spiral Flute	34
Thread Forming Taps.....	30

Solid Carbide

Left Hand	24
Right Hand.....	24
Left Hand - Metric	25
Right Hand - Metric	25

Pipe (Taper)	23
Spiral Point.....	23

TiN Coated

Fractional	5
Machine Screw	5
Thread Forming Taps.....	30

Tap Extensions	38
Tap Guide	80

DIES

Carbon Steel

2 Piece Adjustable.....	61
Hexagon Rethreading	58
Bearing Locknut.....	49
British	51
Pipe.....	58
Solid Square Bolt Dies.....	65

Cobalt

Automatic Thread	50
------------------------	----

High Speed Steel

Cone (Acorn).....	63
Holder	63
Coil Rod Thread	9
Hexagon Rethreading	
Acme Thread.....	64
Automatic	62
Bearing Locknut	49

Hexagon Threading	
Hex Nut Diameter	60
Hex Nut Diameter - NPT	60
Standard Diameter	59
Standard Diameter - NPT.....	59
Round Adjustable.....	50
Bearing Locknut	50
British Standard.....	51
Parallel Pipe.....	48
Taper Pipe	48
Left Hand	41
Right Hand.....	40
Metric	42

Pipe	
Straight Pipe.....	47
Taper Pipe.....	47
Special Thread	
#4 to 5/8".....	44
5/8" to 1-3/16"	45
1-3/16" to 3-1/2".....	46
Special Thread - Metric	43

Tool Steel

Hexagon Rethreading	
Hex Nut Diameter	
Left Hand	52
Right hand.....	52
Metric.....	55
Metric (Special Thread).....	55
Pipe	
NPS.....	53
NPT	53
Special Thread.....	54

Die Adapters.....	79
Die Holders (Floating Round)	79
Die Stocks.....	79
Die Stock Screwdriver	80
Hex Die Stock Tap Adapter.....	80

SCREW EXTRACTORS

Helical Flute	1
Straight Flute	
Round Shank.....	1
Square Shank.....	2
Broken Tap Extractors	4

SETS

Carbon Steel

3 pc (Taper, Plug & Bottoming Chamfer)	5
117 pc (Taps, Dies, Drills, Screw Extractors).....	69

Pipe	
British Standard.....	39
Taper.....	39

Tap and Hex Die	
12 pc Pipe (1/8 to 1)	57
40 pc (#4 to 1/2)	67
40 pc Metric (M3 to M12)	67
58 pc (#6 to 1)	68
65 pc (#4 to 1)	68
Automotive Rethreading	73

Tap & Round Adjustable Die	
45 pc Fractional (1/4-20 to 1-14)	70
45 pc Metric (M6 to M24)	70

High Speed Steel

Miniature	
30 pc (#00 to #3)	74
30 pc - Metric (M1 to M2.5).....	74

Pipe	
British Standard.....	39
Taper.....	39

Tap and Hex Die	
12 pc Pipe (1/8 to 1)	57
40 pc (#4 to 1/2)	67
58 pc (#6 to 1)	68
65 pc (#4 to 1)	68

Tap & Round Adjustable Die	
21 pc (1/4 to 3/4)	72
21 pc Metric (M6 to M20)	72
45 pc Fractional (1/4-20 to 1-14)	70
45 pc Metric (M6 to M24)	70

TiN Coated

Tap & Round Adjustable Die	
21 pc (1/4 to 3/4).....	72
21 pc Metric (M6 to M20)	72

Tool Steel

Hexagon Rethreading	
Die	56
Pipe Die	56
Hexagon Threading	
Die	66

Bolt And Nut Extractor.....	3
Broken Tap Extractor.....	4
Model Airplane Tap.....	74
Multi-Spline Screw Extractor	3
Ratcheting	
5 pc Tap And Die.....	76
7 pc Pipe Threader	75
8 pc Pipe Threader	75
Tap And Drill Sets.....	71

Screw Extractor Sets	2
Screw Extractor And Drill Sets.....	2

Thread Box And Tap Set	81
Tap And Drill Dispenser	71
Tap Dispensers.....	71

OTHER

Screw Pitch Gauges	80
T-Handle Tap Wrenches	
3/8" Square Drive Type	78
Piloted Spindle	78
Plain Type	78
Ratchet Type.....	78
Tap And Reamer Wrenches (Adjustable)	77
Threadlock Plug Gauges	32
Thread Restoring Files	72
Valve Core Tool.....	82

HELICAL FLUTE SCREW EXTRACTORS

ICS WIS

SPECIAL PURPOSE

LEFT HAND CUT

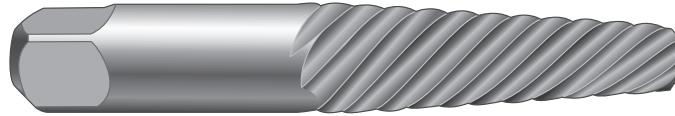
ROUND
SHANKHELICAL
FLUTE

Round Shank Helical Flute Screw Extractors are used to remove broken screws, bolts, studs, pipe, and lubrication fittings without damage to the threaded hole. They are designed with a left hand helical flute to firmly grip and remove any right hand threaded screw or bolt from 3/16" to 3-1/2" in size. They can also be used for turning threaded pipe sections. Sizes #1 to #5 have ground center punch points. Meets Government Specs. GGG-E936B.

SIZE	DRILL SIZE	TAP WRENCH	FOR SCREW	FOR PIPE	ITEM NO.	PRICE EACH	
	TO USE	TO USE	& BOLT SIZES	SIZES		BULK	PKG.
1	5/64	TW-0	3/16 - 1/4	-	SXHF#01	1.64	2.10
2	7/64	TW-0	1/4 - 5/16	-	SXHF#02	1.68	2.14
3	5/32	TW-0	5/16 - 7/16	-	SXHF#03	1.84	2.30
4	1/4	TW-4	7/16 - 9/16	-	SXHF#04	2.18	2.68
5	19/64	TW-5	9/16 - 3/4	1/8 - 1/4	SXHF#05	2.68	3.14
5-1/4	23/64	TW-6	11/16 - 15/16	1/4	SXHF#05.25	5.26	5.74
6	13/32	TW-6	3/4 - 1	3/8	SXHF#06	6.04	6.52
6-3/8	31/64	TW-6	15/16 - 1-1/8	3/8	SXHF#06.375	8.40	8.88
7	17/32	TW-7	1 - 1-3/8	1/2	SXHF#07	10.26	10.72
7-1/2	39/64	TW-7	1-1/8 - 1-1/2	1/2	SXHF#07.5	13.12	13.64
8	13/16	TW-7	1-3/8 - 1-3/4	3/4	SXHF#08	17.20	17.68
9	1-1/16	TW-7.5	1-3/4 - 2-1/8	1	SXHF#09	24.12	24.60
10	1-5/16	TW-8	2-1/8 - 2-1/2	1-1/4	SXHF#10	42.34	-
11	1-9/16	TW-9.5	2-1/2 - 3	1-1/2	SXHF#11	63.48	-
12	1-15/16	TW-9.5	3 - 3-1/2	2	SXHF#12	102.66	-

Please specify Bulk or Packaged when ordering.

STRAIGHT FLUTE SCREW EXTRACTORS

ICS WIS

SPECIAL PURPOSE

RIGHT or LEFT HAND CUT

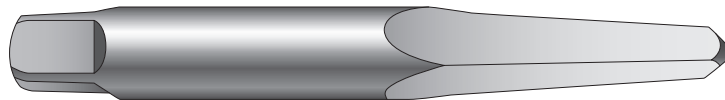
ROUND
SHANKSTRAIGHT
FLUTE

Round Shank Straight Flute Screw Extractors are used to remove broken right or left hand threaded screws, bolts, studs, pipe, and lubrication fittings without damage to the threaded hole. They are designed with four sharp cutting edges to give a right or left hand positive gripping action without binding or chewing. They are preferred for soft metals and thin walled parts as they do not expand the part being removed. Meets Government Specs. GGG-E936C.

SIZE	DRILL SIZE	TAP WRENCH	FOR SCREW	FOR PIPE	ITEM NO.	PRICE EACH	
	TO USE	TO USE	& BOLT SIZES	SIZES		BULK	PKG.
1	5/64	TW-0	1/4 - 5/16	-	SXSFRL#01	2.10	2.58
2	7/64	TW-0	3/8	-	SXSFRL#02	2.24	2.70
3	5/32	TW-0	7/16	1/8	SXSFRL#03	2.42	2.88
4	1/4	TW-4	1/2 - 9/16	1/4	SXSFRL#04	2.90	3.38
5	19/64	TW-5	5/8	3/8	SXSFRL#05	3.44	3.92
6	13/32	TW-6	3/4	1/2	SXSFRL#06	5.66	6.14
7	17/32	TW-7	7/8	-	SXSFRL#07	7.38	7.84

Please specify Bulk or Packaged when ordering.

TOOL STEEL

STRAIGHT FLUTE SCREW EXTRACTORS

ICS WIS

SPECIAL PURPOSE

LEFT HAND CUT

SQUARE SHANK



STRAIGHT FLUTE

Square Shank Straight Flute Screw Extractors are used to remove broken screws, bolts, studs, pipe, and lubrication fittings without damage to the threaded hole. They are designed with four sharp edges to give a positive gripping action without binding or chewing. They are preferred for soft metals and thin walled parts as they do not expand the part being removed. Meets Government Specs. GGG-E936C.

SIZE	DRILL SIZE	TAP WRENCH	FOR SCREW	FOR PIPE	ITEM NO.	PRICE EACH	
	TO USE	TO USE	& BOLT SIZES	SIZES		BULK	PKG.
1	9/64	TW-0	1/4 - 5/16	-	SXSF#01	2.10	2.58
2	3/16	TW-0	3/8	-	SXSF#02	2.24	2.70
3	15/64	TW-0	7/16	1/8	SXSF#03	2.42	2.88
4	5/16	TW-4	1/2 - 9/16	1/4	SXSF#04	2.90	3.38
5	3/8	TW-5	5/8	3/8	SXSF#05	3.44	3.92
6	15/32	TW-6	3/4	1/2	SXSF#06	5.66	6.14
7	9/16	TW-7	7/8	-	SXSF#07	7.38	7.84

Please specify Bulk or Packaged when ordering.

SCREW EXTRACTOR SETS

PLASTIC CASE

ILLUSTRATION	CONTENTS	TYPE	ITEM NO.	PRICE
	Sizes #1 to #9	Helical Flute - Round Shank	SXS-HF-9	100.56
	Sizes #1 to #7		SXS-HF-07	30.00
	Sizes #1 to #6		SXS-HF-06	26.80
	Sizes #1 to #7	Straight Flute - Straight Shank	SXS-SF-07	44.04

VINYL POUCH

5 PC SCREW EXTRACTOR SETS (VINYL POUCH)	Sizes #1 to #5	Helical Flute - Round Shank	SXS-HF-5	12.28
	Sizes #1 to #5	Straight Flute - Square Shank	SXS-SF-5	15.40
	Sizes #1 to #5	Straight Flute - Round Shank	SXS-SFR-5	17.34

SCREW EXTRACTOR AND DRILL SETS

METAL CASE

CONTENTS	TYPE OF SCREW EXTRACTOR & DRILLS	ITEM NO.	PRICE
10 PC SCREW EXTRACTOR SET One each Sizes #1 to #5 Screw Extractors One each 5/64, 7/64, 5/32, 1/4, 19/64 Screw Machine Drills with RH or LH cut	Helical Flute Screw Extractors Screw Machine Drills - RH cut	SXDS-10	23.52
	Helical Flute Screw Extractors Screw Machine Drills - LH cut	SXDS-10L	36.50

10 PC MULTI-SPLINE SCREW EXTRACTOR SET

PLASTIC CASE

Hex Head Multi-Spline Screw Extractors are used to remove broken studs, bolts, socket screws, and lubrication fittings. They are designed with an aggressive left hand spiral design for maximum gripping power and can be used with a socket or flat wrench.

ILLUSTRATION	DESCRIPTION	ITEM NO.	PRICE																					
 <p>10 PC MULTI-SPLINE SCREW EXTRACTOR SET</p>	<p>Each set contains the following multi-spline screw extractor sizes:</p> <p>1/8, 5/32, 3/16, 7/32, 1/4, 9/32, 5/16, 11/32, 3/8, 13/32</p>	MSSXS-10	32.30																					
	<table border="1"> <thead> <tr> <th>MULTI-SPLINE SCREW EXTRACTOR</th> <th>FOR BOLT SIZE</th> <th>MULTI-SPLINE SCREW EXTRACTOR</th> <th>FOR BOLT SIZE</th> </tr> </thead> <tbody> <tr> <td>1/8</td> <td>#12</td> <td>9/32</td> <td>1/2</td> </tr> <tr> <td>5/32</td> <td>1/4</td> <td>5/16</td> <td>9/16</td> </tr> <tr> <td>3/16</td> <td>5/16</td> <td>11/32</td> <td>5/8</td> </tr> <tr> <td>7/32</td> <td>3/8</td> <td>3/8</td> <td>11/16</td> </tr> <tr> <td>1/4</td> <td>7/16</td> <td>13/32</td> <td>3/4</td> </tr> </tbody> </table>			MULTI-SPLINE SCREW EXTRACTOR	FOR BOLT SIZE	MULTI-SPLINE SCREW EXTRACTOR	FOR BOLT SIZE	1/8	#12	9/32	1/2	5/32	1/4	5/16	9/16	3/16	5/16	11/32	5/8	7/32	3/8	3/8	11/16	1/4
MULTI-SPLINE SCREW EXTRACTOR	FOR BOLT SIZE	MULTI-SPLINE SCREW EXTRACTOR	FOR BOLT SIZE																					
1/8	#12	9/32	1/2																					
5/32	1/4	5/16	9/16																					
3/16	5/16	11/32	5/8																					
7/32	3/8	3/8	11/16																					
1/4	7/16	13/32	3/4																					

10 PC BOLT AND NUT EXTRACTOR SET

ALUMINUM CASE

Hex Head Bolt and Nut Extractors are used for removing damaged fasteners and rounded-off hex bolts and nuts. They are designed with a reverse spiral flute to grip a damaged fastener as you turn the tool and they can be used with most wrenches or a ratchet socket. They will remove both metric and inch size fasteners from 9-19mm or 3/8" to 3/4".

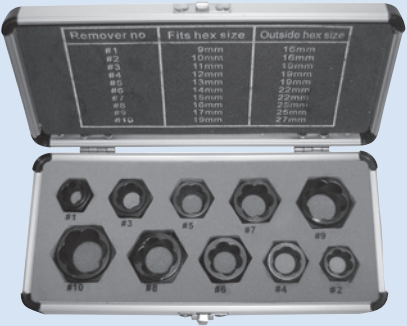
ILLUSTRATION	DESCRIPTION	ITEM NO.	PRICE																					
 <p>10 PC MULTI-SPLINE SCREW EXTRACTOR SET</p>	<p>Each set contains one each:</p> <p>#1 to #10 extractor</p>	BNXS-10M	32.56																					
	<table border="1"> <thead> <tr> <th>BOLT & NUT EXTRACTOR</th> <th>FITS HEX SIZE</th> <th>BOLT & NUT EXTRACTOR</th> <th>FITS HEX SIZE</th> </tr> </thead> <tbody> <tr> <td>#1</td> <td>9mm 3/8</td> <td>#6</td> <td>14mm 9/16</td> </tr> <tr> <td>#2</td> <td>10mm</td> <td>#7</td> <td>15mm</td> </tr> <tr> <td>#3</td> <td>11mm 7/16</td> <td>#8</td> <td>16mm 5/8</td> </tr> <tr> <td>#4</td> <td>12mm</td> <td>#9</td> <td>17mm</td> </tr> <tr> <td>#5</td> <td>13mm 1/2</td> <td>#10</td> <td>19mm 3/4</td> </tr> </tbody> </table>			BOLT & NUT EXTRACTOR	FITS HEX SIZE	BOLT & NUT EXTRACTOR	FITS HEX SIZE	#1	9mm 3/8	#6	14mm 9/16	#2	10mm	#7	15mm	#3	11mm 7/16	#8	16mm 5/8	#4	12mm	#9	17mm	#5
BOLT & NUT EXTRACTOR	FITS HEX SIZE	BOLT & NUT EXTRACTOR	FITS HEX SIZE																					
#1	9mm 3/8	#6	14mm 9/16																					
#2	10mm	#7	15mm																					
#3	11mm 7/16	#8	16mm 5/8																					
#4	12mm	#9	17mm																					
#5	13mm 1/2	#10	19mm 3/4																					

10 PC BROKEN TAP EXTRACTOR SET

ICS WIS

PLASTIC CASE

ICS Broken Tap Extractors are used to remove broken taps without damage to the threaded hole. They have hardened steel fingers to fit in the flutes of a broken tap to turn it out safely, and can be used with a socket or tap wrench.

ILLUSTRATION	DESCRIPTION	ITEM NO.	PRICE	
	Each set contains tap extractors #1 to #10	BTXS-10	51.24	
	TAP EXTRACTOR	FOR TAP SIZE		NO. OF FLUTES
	SIZE	INCH	METRIC	
	#1	#6	4mm	3
	#2	#8-10	5mm	3
	#3	1/4	6mm	4
	#4	5/16	8mm	4
	#5	3/8	10mm	4
	#6	1/2	12mm	4
	#7	9/16	14mm	4
#8	5/8	16mm	4	
#9	3/4	18-20mm	4	
#10	7/8	22mm	4	

BROKEN TAP EXTRACTORS

ICS WIS

SPECIAL PURPOSE

ICS Broken Tap Extractors are used to remove broken taps without damage to the threaded hole. They have hardened steel fingers to fit in the flutes of a broken tap to turn it out safely, and can be used with a socket or tap wrench.



ITEM NO.	TAP EXTRACTOR SIZE	FOR TAP SIZE		NO. OF FLUTES	PRICE
		INCH	METRIC		
BTX#00	#0	#5	3mm	3	5.26
BTX#01	#1	#6	4mm	3	4.52
BTX#02	#2	#8-10	5mm	3	4.52
BTX#03	#3	1/4	6mm	4	4.52
BTX#04	#4	5/16	8mm	4	4.62
BTX#05	#5	3/8	10mm	4	4.94
BTX#06	#6	1/2	12mm	4	6.08
BTX#07	#7	9/16	14mm	4	6.90
BTX#08	#8	5/8	16mm	4	7.66
BTX#09	#9	3/4	18-20mm	4	9.48
BTX#10	#10	7/8	22mm	4	10.86
BTX#11	#11	1	24mm	4	20.48
BTX#12	#12	1-1/8	27mm	4	31.50
BTX#13	#13	1-1/4	30mm	4	39.38

HIGH SPEED STEEL - TITANIUM NITRIDE COATED STANDARD HAND TAPS

ICS **WIS**

GENERAL PURPOSE

GROUND THREAD

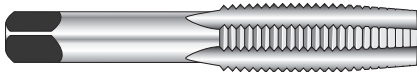

TAPER TAP
7-10 Thread Chamfer
at 5 degrees per side

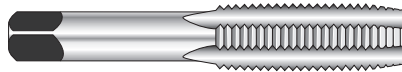

PLUG TAP
3-5 Thread Chamfer
at 8 degrees per side

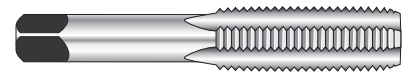

BOTTOMING TAP
1-2 Thread Chamfer
at 18 degrees per side

High Speed Steel Hand Taps with straight flutes are designed for general purpose hand tapping or in production machines where ground thread accuracy and performance are required. They are suitable for tapping most materials in through or blind holes. Hand taps retain chips in the flutes during use and work best on materials that produce chips and the swarf breaks easily. They are also known as Straight Flute Taps.

SIZE	THREADS PER INCH					NO. OF FLUTES	LIMIT NO.	PRICE EACH			TAP DRILL SIZE APPROXIMATELY 75% THREAD		
	NC UNC	NF UNF	NS	NO.	HIGH SPEED STEEL			TIN COATED					
					TAPER, PLUG or BOTTOMING			TAPER, PLUG & BOTTOMING (3 PC SET)	TAPER, PLUG or BOTTOMING				
					SHT			SHTS	SHTT				
0	-	80	-	2	H1	11.60	34.78	13.94	-	3/64	-		
1	64	72	-	2	H1	10.78	32.32	13.12	53	53	-		
2	56	64	-	3	H2	8.82	26.46	11.18	50	50	-		
3	48	56	-	3	H2	7.18	21.56	9.54	47	45	-		
4	40	48	36	3	H2	5.66	18.90	8.00	43	44	42		
5	40	44	-	3	H2	5.66	16.96	8.00	38	37	-		
6	32	40	-	3	H3	4.24	12.74	6.48	36	33	-		
8	32	36	-	4	H3	4.58	13.74	8.68	29	29	-		
10	24	32	-	4	H3	4.58	13.74	8.68	25	21	-		
12	24	28	-	4	H3	6.14	18.40	10.36	16	14	-		
1/4	20	28	-	4	H3	4.80	14.36	9.02	7	3	-		
5/16	18	24	-	4	H3	6.30	18.90	12.08	"F"	"I"	-		
3/8	16	24	-	4	H3	8.20	24.60	13.76	5/16	"Q"	-		
7/16	14	20	-	4	H3	12.28	36.84	18.74	"U"	25/64	-		
1/2	13	20	-	4	H3	12.78	38.30	19.68	27/64	29/64	-		
9/16	12	18	-	4	H3	15.76	47.26	27.24	31/64	33/64	-		
5/8	11	18	-	4	H3	19.70	59.10	30.84	17/32	37/64	-		
11/16	-	-	11	4	H3	23.10	69.30	33.60	-	-	19/32		
11/16	-	-	16	4	H3	23.10	69.30	33.60	-	-	5/8		
3/4	10	16	-	4	H3	26.72	80.14	39.66	21/32	11/16	-		
7/8	9	14	-	4	H4	36.94	110.82	55.04	49/64	13/16	-		
1	8	12	14	4	H4	56.46	169.34	83.40	7/8	15/16	59/64		
1-1/8	7	12	-	4	H4	84.28	252.82	138.04	63/64	1-3/64	-		
1-1/4	7	12	-	4-6	H4	106.92	320.72	160.66	1-7/64	1-11/64	-		
1-3/8	6	12	-	4-6	H4	134.42	403.26	188.16	1-7/32	1-19/64	-		
1-1/2	6	12	-	4-6	H4	169.12	507.34	222.86	1-11/32	1-27/64	-		
1-3/4	5	-	-	6	H4				1-9/16	-	-		
2	4-1/2	-	-	6	H4	CALL	CALL	CALL	1-25/32	-	-		
2-1/4	4-1/2	-	-	6	H6	FOR	FOR	FOR	2-1/32	-	-		
2-1/2	4	-	-	6	H6	PRICE	PRICE	PRICE	2-1/4	-	-		
3	4	-	-	6	H10				2-3/4	-	-		
3-1/2	4	-	-	6	H10				3-1/4	-	-		

PITCH DIAMETER LIMIT SYMBOLS
H: (High) Pitch Dia. is above basic. The number following "H" is the number of .0005" steps above the basic pitch diameter. Taps larger than 1" dia. have .0010" steps.
LIMITS FOR TAPS TO 1" DIAMETER
H1 = Basic to Basic + .0005"
H2 = Basic + .0005" to basic + .0010"
H3 = Basic + .0010" to basic + .0015"
H4 = Basic + .0015" to basic + .0020"
LIMITS FOR TAPS TO 1" DIAMETER
H4 = Basic + .001" to basic .002"

PACKAGING

#6 to 1/2 - 12 taps/box
 9/16 to 1 - 3 taps/box
 1-1/8 to 1-3/4 - 1 tap/tube

THREAD FORM SYMBOLS
NC American National Coarse Thread Series
UNC Unified Coarse Thread Series
NF American National Fine Thread Series
UNF Unified Fine Thread Series
NS American National Thread - Special

• Please specify Taper (T), Plug (P) or Bottoming (B) chamfer. Examples: SHT#06-32T, SHT#06-32P, SHT#06-32B.

HIGH SPEED STEEL DOUBLE, TRIPLE & QUAD LEAD TAPS

ICS USA

SPECIAL PURPOSE

GROUND THREAD

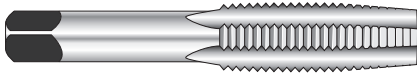

TAPER TAP
7-10 Thread Chamfer
at 5 degrees per side

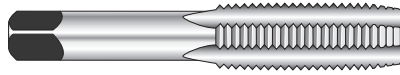

PLUG TAP
3-5 Thread Chamfer
at 8 degrees per side

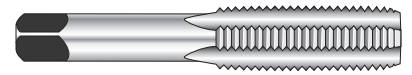

BOTTOMING TAP
1-2 Thread Chamfer
at 18 degrees per side

Multiple Lead Taps are designed for use in adjusting mechanisms where a clockwise turn will make a linear distance movement 2, 3 or 4 times the distance of a single lead tap. Most standard and special sizes and different leads are available or can be manufactured. Please inquire for pricing. Multiple Lead Taps are also known as Multiple Start Taps.

THREADS SIZE	NO. OF PER INCH FLUTES	LIMIT NO.	ITEM NO.									
			DOUBLE LEAD			TRIPLE LEAD			QUAD LEAD			
NC - UNC Coarse Thread												
			BOTTOM	PLUG	TAPER	BOTTOM	PLUG	TAPER	BOTTOM	PLUG	TAPER	
6	32	3	H3	HT2L#06-32B	HT2L#06-32P	HT2L#06-32T	HT3L#06-32B	HT3L#06-32P	HT3L#06-32T	HT4L#06-32B	HT4L#06-32P	HT4L#06-32T
8	32	4	H3	HT2L#08-32B	HT2L#08-32P	HT2L#08-32T	HT3L#08-32B	HT3L#08-32P	HT3L#08-32T	HT4L#08-32B	HT4L#08-32P	HT4L#08-32T
10	24	4	H3	HT2L#10-24B	HT2L#10-24P	HT2L#10-24T	HT3L#10-24B	HT3L#10-24P	HT3L#10-24T	HT4L#10-24B	HT4L#10-24P	HT4L#10-24T
12	24	4	H3	HT2L#12-24B	HT2L#12-24P	HT2L#12-24T	HT3L#12-24B	HT3L#12-24P	HT3L#12-24T	HT4L#12-24B	HT4L#12-24P	HT4L#12-24T
1/4	20	4	H3	HT2L016-20B	HT2L016-20P	HT2L016-20T	HT3L016-20B	HT3L016-20P	HT3L016-20T	HT4L016-20B	HT4L016-20P	HT4L016-20T
5/16	18	4	H3	HT2L020-18B	HT2L020-18P	HT2L020-18T	HT3L020-18B	HT3L020-18P	HT3L020-18T	HT4L020-18B	HT4L020-18P	HT4L020-18T
3/8	16	4	H3	HT2L024-16B	HT2L024-16P	HT2L024-16T	HT3L024-16B	HT3L024-16P	HT3L024-16T	HT4L024-16B	HT4L024-16P	HT4L024-16T
7/16	14	4	H3	HT2L028-14B	HT2L028-14P	HT2L028-14T	HT3L028-14B	HT3L028-14P	HT3L028-14T	HT4L028-14B	HT4L028-14P	HT4L028-14T
1/2	13	4	H3	HT2L032-13B	HT2L032-13P	HT2L032-13T	HT3L032-13B	HT3L032-13P	HT3L032-13T	HT4L032-13B	HT4L032-13P	HT4L032-13T
5/8	11	4	H3	HT2L040-11B	HT2L040-11P	HT2L040-11T	HT3L040-11B	HT3L040-11P	HT3L040-11T	HT4L040-11B	HT4L040-11P	HT4L040-11T
3/4	10	4	H3	HT2L048-10B	HT2L048-10P	HT2L048-10T	HT3L048-10B	HT3L048-10P	HT3L048-10T	HT4L048-10B	HT4L048-10P	HT4L048-10T
1	8	4	H4	HT2L100-08B	HT2L100-08P	HT2L100-08T	HT3L100-08B	HT3L100-08P	HT3L100-08T	HT4L100-08B	HT4L100-08P	HT4L100-08T
NF - UNF Fine Thread												
				BOTTOM	PLUG	TAPER	BOTTOM	PLUG	TAPER	BOTTOM	PLUG	TAPER
6	40	3	H3	HT2L#06-40B	HT2L#06-40P	HT2L#06-40T	HT3L#06-40B	HT3L#06-40P	HT3L#06-40T	HT4L#06-40B	HT4L#06-40P	HT4L#06-40T
8	36	4	H3	HT2L#08-36B	HT2L#08-36P	HT2L#08-36T	HT3L#08-36B	HT3L#08-36P	HT3L#08-36T	HT4L#08-36B	HT4L#08-36P	HT4L#08-36T
10	32	4	H3	HT2L#10-32B	HT2L#10-32P	HT2L#10-32T	HT3L#10-32B	HT3L#10-32P	HT3L#10-32T	HT4L#10-32B	HT4L#10-32P	HT4L#10-32T
12	28	4	H3	HT2L#12-28B	HT2L#12-28P	HT2L#12-28T	HT3L#12-28B	HT3L#12-28P	HT3L#12-28T	HT4L#12-28B	HT4L#12-28P	HT4L#12-28T
1/4	28	4	H3	HT2L016-28B	HT2L016-28P	HT2L016-28T	HT3L016-28B	HT3L016-28P	HT3L016-28T	HT4L016-28B	HT4L016-28P	HT4L016-28T
5/16	24	4	H3	HT2L020-24B	HT2L020-24P	HT2L020-24T	HT3L020-24B	HT3L020-24P	HT3L020-24T	HT4L020-24B	HT4L020-24P	HT4L020-24T
3/8	24	4	H3	HT2L024-24B	HT2L024-24P	HT2L024-24T	HT3L024-24B	HT3L024-24P	HT3L024-24T	HT4L024-24B	HT4L024-24P	HT4L024-24T
7/16	20	4	H3	HT2L028-20B	HT2L028-20P	HT2L028-20T	HT3L028-20B	HT3L028-20P	HT3L028-20T	HT4L028-20B	HT4L028-20P	HT4L028-20T
1/2	20	4	H3	HT2L032-20B	HT2L032-20P	HT2L032-20T	HT3L032-20B	HT3L032-20P	HT3L032-20T	HT4L032-20B	HT4L032-20P	HT4L032-20T
5/8	18	4	H3	HT2L040-18B	HT2L040-18P	HT2L040-18T	HT3L040-18B	HT3L040-18P	HT3L040-18T	HT4L040-18B	HT4L040-18P	HT4L040-18T
3/4	16	4	H3	HT2L048-16B	HT2L048-16P	HT2L048-16T	HT3L048-16B	HT3L048-16P	HT3L048-16T	HT4L048-16B	HT4L048-16P	HT4L048-16T
1	12	4	H4	HT2L100-12B	HT2L100-12P	HT2L100-12T	HT3L100-12B	HT3L100-12P	HT3L100-12T	HT4L100-12B	HT4L100-12P	HT4L100-12T

CALL FOR PRICING

LEAD TAP COMPARISON EXAMPLE

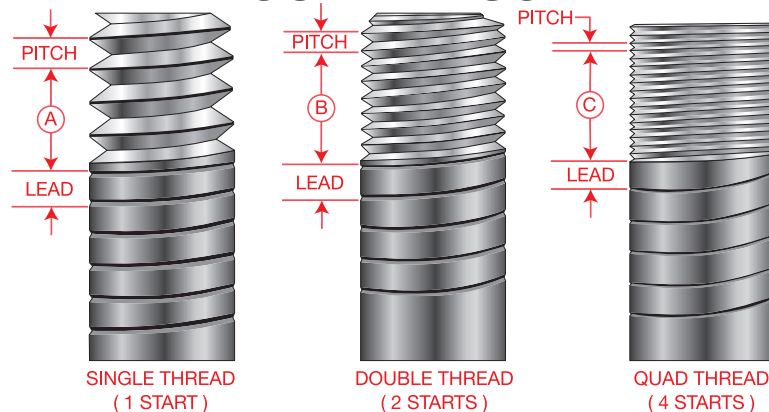

Multiple Lead Taps are also known as Multiple Start Taps.

NOTES

- 1) Small multiple lead taps should be double checked that they are centered in the hole.
- 2) Use a long lead chamfer and low speed to reduce pressure.
- 3) Consider doing threading in two steps using a roughing and finisher tap.

HIGH SPEED STEEL LEFT HAND TAPS

ICS USA

SPECIAL PURPOSE

GROUND THREAD

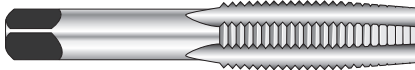

TAPER TAP
7-10 Thread Chamfer
at 5 degrees per side

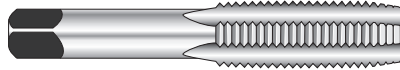

PLUG TAP
3-5 Thread Chamfer
at 8 degrees per side

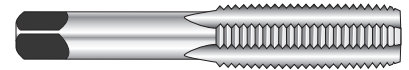

BOTTOMING TAP
1-2 Thread Chamfer
at 18 degrees per side

High Speed Steel Left Hand Taps with straight flutes are designed to cut threads with a left hand rotation and are commonly used in applications where left hand studs and fasteners are needed. They can be used by hand or in production machines where ground thread accuracy and performance are required. They are suitable for tapping most materials in through or blind holes.

SIZE	THREADS PER INCH			NO. OF FLUTES	LIMIT NO.	PRICE	
	NC UNC	NF UNF	NS			TAPER PLUG or BOTTOM	TAPER, PLUG & BOTTOM 3 PC SET
						SHTL	SHTLS
6	32	-	-	3	H3	7.42	22.26
8	32	-	-	4	H3	7.42	22.26
10	24	32	-	4	H3	7.42	22.26
1/4	20	28	-	4	H3	7.70	23.10
5/16	18	24	-	4	H3	8.62	25.86
3/8	16	24	-	4	H3	10.38	31.14
7/16	14	20	-	4	H3	15.36	46.08
1/2	13	20	-	4	H3	18.06	54.18
9/16	12	18	-	4	H3	23.46	70.38

SIZE	THREADS PER INCH			NO. OF FLUTES	LIMIT NO.	PRICE	
	NC UNC	NF UNF	NS			TAPER PLUG or BOTTOM	TAPER, PLUG & BOTTOM 3 PC SET
						SHTL	SHTLS
5/8	11	18	-	4	H3	29.06	87.18
3/4	10	16	-	4	H3	40.70	122.10
7/8	9	14	12	4	H4	55.80	167.40
1	8	12	14	4	H4	76.52	229.56
1-1/8	7	12	8	4	H4	111.50	-
1-1/4	7	12	8	4-6	H4	149.30	-
1-3/8	6	12	8	4-6	H4	184.94	-
1-1/2	6	12	8	4-6	H4	219.68	-
1-3/4	-	-	8	6	H4	239.86	-

HIGH SPEED STEEL +.005 OVERSIZE HAND TAPS

ICS USA

SPECIAL PURPOSE

GROUND THREAD

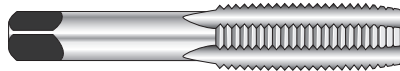

PLUG CHAMFER

High Speed Steel +.005 Oversize Hand Taps are designed to be used where a part will be plated or heat treated after tapping or where a loss of size is expected. They produce threads with a pitch diameter that is .005 larger than the basic pitch diameter. They are suitable for most materials in through or blind holes, especially plastics and synthetic resins. They are also referred to as Pre-Plate Taps.

SIZE	THREADS PER INCH			NO. OF FLUTES	PRICE	
	NC UNC	NF UNF	NS		HSS	SHTO
6	32	40	-	3	7.34	7.34
8	32	36	-	4	7.34	7.34
10	24	32	-	4	7.34	7.34
1/4	20	28	-	4	7.34	7.34
5/16	18	24	-	4	8.62	8.62
3/8	16	24	-	4	10.44	10.44
7/16	14	20	-	4	17.40	17.40
1/2	13	20	-	4	18.08	18.08

SIZE	THREADS PER INCH			NO. OF FLUTES	PRICE	
	NC UNC	NF UNF	NS		HSS	SHTO
5/8	11	18	-	4	35.46	35.46
3/4	10	16	-	4	49.66	49.66
7/8	9	14	-	4	58.94	58.94
1	8	12	14	4	78.54	78.54
1-1/8	7	12	-	4-6	101.40	101.40
1-1/4	7	12	-	4-6	128.84	128.84
1-3/8	6	12	-	4-6	158.40	158.40
1-1/2	6	12	-	4-6	186.04	186.04

HIGH SPEED STEEL SPECIAL OVERSIZE HAND TAPS

ICS USA

SPECIAL PURPOSE

GROUND THREAD

**STEAM HOMO
THREAD PROTECTION**

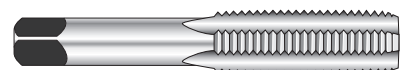

**SPECIAL BOTTOM
CHAMFER**

Special Oversize Hand Taps are used for tough dirty jobs. Profiled (flame cut) parts, with scale, and punched holes with burrs. The parts are subsequently shot-blasted and hot dip galvanized. The amount of oversize is to allow for heavy zinc deposition in the threads. They are also referred to as Pre-Plate Taps.

SIZE	THREADS PER INCH	NO. OF FLUTES	DECIMAL OVERSIZE	PRICE	
				HSS	OHT
1/4	20	4	+.015	-	-
5/16	18	4	+.015	CALL FOR PRICE	-
3/8	16	4	+.015	CALL FOR PRICE	-
1/2	13	4	+.020	-	-
5/8	11	4	+.020	-	-
3/4	10	4	+.020	-	-

SIZE	THREADS PER INCH	NO. OF FLUTES	DECIMAL OVERSIZE	PRICE	
				HSS	OHT
1	8	4	+.020	-	-
1-1/8	7	4	+.030	CALL FOR PRICE	-
1-1/4	7	4	+.030	CALL FOR PRICE	-
1-3/8	6	6	+.030	-	-
1-1/2	6	6	+.030	-	-

* Inquire for special oversize hand taps not listed.

* Price quoted upon request.

HIGH SPEED STEEL EIGHT PITCH HAND TAPS

ICS **WIS**

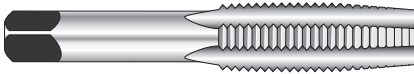

TAPER TAP
7-10 Thread Chamfer
at 5 degrees per side

SPECIAL PURPOSE

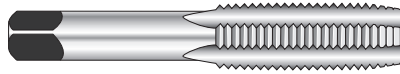

PLUG TAP
3-5 Thread Chamfer
at 8 degrees per side

GROUND THREAD

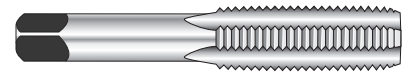

BOTTOMING TAP
1-2 Thread Chamfer
at 18 degrees per side

Eight Pitch Hand Taps are classified as coarse pitch series taps. They were originally designed for threading large diameter, high pressure joint bolts and nuts and are now used mainly by oil related industries, utilities, and general construction.

SIZE	THREADS PER INCH	NO. OF FLUTES	LIMIT NO.	ITEM NO.			PRICE
				TAPER	PLUG	BOTTOMING	
1-1/16	8	4	H4	STHT104-08T	STHT104-08P	STHT104-08B	89.60
1-1/8	8	4	H4	STHT108-08T	STHT108-08P	STHT108-08B	103.18
1-3/16	8	4	H4	STHT112-08T	STHT112-08P	STHT112-08B	124.32
1-1/4	8	4	H4	STHT116-08T	STHT116-08P	STHT116-08B	132.20
1-5/16	8	4	H4	STHT120-08T	STHT120-08P	STHT120-08B	167.74
1-3/8	8	4	H4	STHT124-08T	STHT124-08P	STHT124-08B	167.74
1-7/16	8	4	H5	STHT128-08T	STHT128-08P	STHT128-08B	194.20
1-1/2	8	4	H4	STHT132-08T	STHT132-08P	STHT132-08B	192.84
1-5/8	8	6	H6	STHT140-08T	STHT140-08P	STHT140-08B	221.44
1-3/4	8	6	H6	STHT148-08T	STHT148-08P	STHT148-08B	285.36
1-7/8	8	6	H6	STHT156-08T	STHT156-08P	STHT156-08B	390.62
2	8	6	H6	STHT200-08T	STHT200-08P	STHT200-08B	-
2-1/8	8	6	H6	STHT208-08T	STHT208-08P	STHT208-08B	-
2-1/4	8	6	H6	STHT216-08T	STHT216-08P	STHT216-08B	-
2-3/8	8	6	H6	STHT224-08T	STHT224-08P	STHT224-08B	-
2-1/2	8	6	H8	STHT232-08T	STHT232-08P	STHT232-08B	-
2-5/8	8	6	H8	STHT240-08T	STHT240-08P	STHT240-08B	-
2-3/4	8	6	H8	STHT248-08T	STHT248-08P	STHT248-08B	CALL FOR PRICE
2-7/8	8	6	H8	STHT256-08T	STHT256-08P	STHT256-08B	-
3	8	6	H8	STHT300-08T	STHT300-08P	STHT300-08B	-
3-1/8	8	6	H8	STHT308-08T	STHT308-08P	STHT308-08B	-
3-1/4	8	6	H8	STHT316-08T	STHT316-08P	STHT316-08B	-
3-3/8	8	6	H8	STHT324-08T	STHT324-08P	STHT324-08B	-
3-1/2	8	6	H8	STHT332-08T	STHT332-08P	STHT332-08B	-
3-3/4	8	6	H8	STHT348-08T	STHT348-08P	STHT348-08B	-
4	8	6	H10	STHT400-08T	STHT400-08P	STHT400-08B	-

HIGH SPEED STEEL TEN PITCH SUCKER ROD HAND TAPS

ICS **WIS**

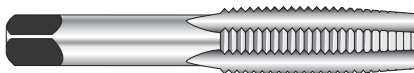

TAPER TAP
7-10 Thread Chamfer
at 5 degrees per side

SPECIAL PURPOSE

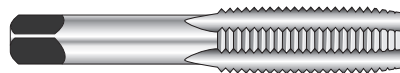

PLUG TAP
3-5 Thread Chamfer
at 8 degrees per side

GROUND THREAD

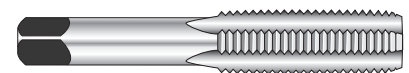

BOTTOMING TAP
1-2 Thread Chamfer
at 18 degrees per side

High Speed Steel Ten Pitch Sucker Rod Hand Taps were designed for use by oil pumping stations to thread sucker rod and other applications requiring quick assembly. They are made specifically for this purpose and should not be considered the same as regular ten pitch intermediate series taps.

SIZE	THREADS PER INCH	SIZE OF ROD	NO. OF FLUTES	LIMIT NO.	ITEM NO.			PRICE
					TAPER	PLUG	BOTTOMING	
3/4	10	1/2	4	H3	SRHT048-10T	SRHT048-10P	SRHT048-10B	-
15/16	10	5/8	4	H4	SRHT060-10T	SRHT060-10P	SRHT060-10B	CALL FOR PRICE
1-1/16	10	3/4	4	H5	SRHT104-10T	SRHT104-10P	SRHT104-10B	-
1-3/16	10	7/8	4	H5	SRHT112-10T	SRHT112-10P	SRHT112-10B	CALL FOR PRICE
1-3/8	10	1	4	H5	SRHT124-10T	SRHT124-10P	SRHT124-10B	-
1-9/16	10	1-1/8	6	H5	SRHT136-10T	SRHT136-10P	SRHT136-10B	-

HIGH SPEED STEEL COIL ROD THREAD TAPS

ICS USA

SPECIAL PURPOSE

GROUND THREAD

**EXTRA
LONG LIFE**

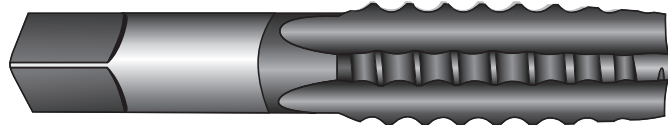

**TiALN
COATED**

High Speed Steel Coil Rod Thread Taps are designed for threading or rethreading holes for coil threaded rod used in concrete forming applications. These taps are coated with Titanium Aluminum Nitride (TiALN) to last up to 10 times longer than uncoated taps.

NOMINAL THREAD SIZE	SIZE OF COIL ROD	NO. OF FLUTES	TAP DRILL SIZE	ITEM NO.	PRICE
3/8 - 7	3/8	2	21/64	CRTT024-07	-
1/2 - 6	1/2	3-4	7/16	CRTT032-06	-
3/4 - 4-1/2	3/4	4	21/32	CRTT048-04.5	CALL PRICE
1 - 3-1/2	1	4	7/8	CRTT100-03.5	PRICE
1-1/4 - 3-1/2	1-1/4	4	1-1/8	CRTT116-03.5	-

HIGH SPEED STEEL COIL ROD THREADING HEX DIES

ICS USA

SPECIAL PURPOSE

GROUND THREAD

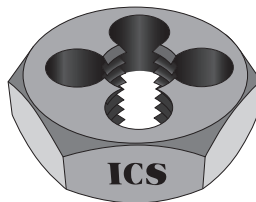

High Speed Steel Coil Rod Thread Hexagon Dies are of heavy duty extra thick construction for the rethreading and threading of coil thread rods, bolts and studs.

SIZE OF COIL ROD	THREAD SIZE	DIAMETER ACROSS FLATS	DIE THICKNESS	ITEM NO.	PRICE
1/2	1/2 - 6	1-1/16	.800	CRTTHTD032-06	CALL FOR PRICE
3/4	3/4 - 4-1/2	1-7/16	1.000	CRTTHTD048-04.5	
1	1 - 3-1/2	1-13/16	1.200	CRTTHTD100-03.5	
1-1/4	1-1/4 - 3-1/2	2-3/16	1.300	CRTTHTD116-03.5	

HIGH SPEED STEEL SPECIAL THREAD HAND TAPS

ICS WIS

SPECIAL PURPOSE

GROUND THREAD

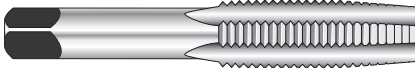

TAPER TAP (T)
7-10 Thread Chamfer
at 5 degrees per side

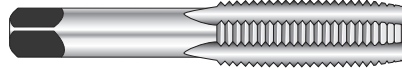

PLUG TAP (P)
3-5 Thread Chamfer
at 8 degrees per side

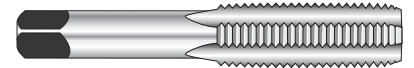

BOTTOMING TAP (B)
1-2 Thread Chamfer
at 18 degrees per side

Special Thread Hand Taps are designed for applications where standard coarse, fine, or extra-fine thread taps are not applicable or where design considerations require non-standard pitches. Most sizes are available in taper, bottoming or plug chamfer. When taper or bottoming chamfer taps are not available in size ordered, plug chamfer taps will be substituted to complete order.

SIZES #6 - 36 to 11/16" - 27

SIZE	T.P.I.	CHAMFER	ITEM NO.	PRICE
#6	36	BOTTOM	STHT#06-36B	10.30
#6	36	PLUG	STHT#06-36P	10.30
#6	36	TAPER	STHT#06-36T	10.30
#6	48	BOTTOM	STHT#06-48B	10.30
#6	48	PLUG	STHT#06-48P	10.30
#6	48	TAPER	STHT#06-48T	10.30
#7	36	BOTTOM	STHT#07-36B	10.30
#7	36	PLUG	STHT#07-36P	10.30
#7	36	TAPER	STHT#07-36T	10.30
#7	40	BOTTOM	STHT#07-40B	10.30
#7	40	PLUG	STHT#07-40P	10.30
#7	40	TAPER	STHT#07-40T	10.30
#7	48	BOTTOM	STHT#07-48B	10.30
#7	48	PLUG	STHT#07-48P	10.30
#7	48	TAPER	STHT#07-48T	10.30
#8	24	BOTTOM	STHT#08-24B	10.30
#8	24	PLUG	STHT#08-24P	10.30
#8	24	TAPER	STHT#08-24T	10.30
#8	40	BOTTOM	STHT#08-40B	10.30
#8	40	PLUG	STHT#08-40P	10.30
#8	40	TAPER	STHT#08-40T	10.30
#8	48	BOTTOM	STHT#08-48B	10.30
#8	48	PLUG	STHT#08-48P	10.30
#8	48	TAPER	STHT#08-48T	10.30
#10	28	BOTTOM	STHT#10-28B	10.30
#10	28	PLUG	STHT#10-28P	10.30
#10	28	TAPER	STHT#10-28T	10.30
#10	36	BOTTOM	STHT#10-36B	10.30
#10	36	PLUG	STHT#10-36P	10.30
#10	36	TAPER	STHT#10-36T	10.30
#10	40	BOTTOM	STHT#10-40B	10.30
#10	40	PLUG	STHT#10-40P	10.30
#10	40	TAPER	STHT#10-40T	10.30
#10	48	BOTTOM	STHT#10-48B	10.30
#10	48	PLUG	STHT#10-48P	10.30
#10	48	TAPER	STHT#10-48T	10.30
#12	32	BOTTOM	STHT#12-32B	10.30
#12	32	PLUG	STHT#12-32P	10.30
#12	32	TAPER	STHT#12-32T	10.30
#12	36	BOTTOM	STHT#12-36B	10.30
#12	36	PLUG	STHT#12-36P	10.30
#12	36	TAPER	STHT#12-36T	10.30
#12	40	BOTTOM	STHT#12-40B	10.30
#12	40	PLUG	STHT#12-40P	10.30
#12	40	TAPER	STHT#12-40T	10.30
#12	48	BOTTOM	STHT#12-48B	10.30
#12	48	PLUG	STHT#12-48P	10.30
#12	48	TAPER	STHT#12-48T	10.30
1/4	24	BOTTOM	STHT016-24B	8.92
1/4	24	PLUG	STHT016-24P	8.92
1/4	24	TAPER	STHT016-24T	8.92
1/4	26	BOTTOM	STHT016-26B	8.92
1/4	26	PLUG	STHT016-26P	8.92
1/4	26	TAPER	STHT016-26T	8.92
1/4	27	BOTTOM	STHT016-27B	8.92
1/4	27	PLUG	STHT016-27P	8.92
1/4	32	BOTTOM	STHT016-32B	8.92
1/4	32	PLUG	STHT016-32P	8.92
1/4	32	TAPER	STHT016-32T	8.92
1/4	36	BOTTOM	STHT016-36B	8.92
1/4	36	PLUG	STHT016-36P	8.92
1/4	36	TAPER	STHT016-36T	8.92
1/4	40	BOTTOM	STHT016-40B	8.92
1/4	40	PLUG	STHT016-40P	8.92
1/4	40	TAPER	STHT016-40T	8.92
1/4	48	BOTTOM	STHT016-48B	8.92
1/4	48	PLUG	STHT016-48P	8.92
1/4	48	TAPER	STHT016-48T	8.92
9/32	27	PLUG	STHT018-27P	13.12
9/32	32	BOTTOM	STHT018-32B	13.12
9/32	32	PLUG	STHT018-32P	13.12
9/32	32	TAPER	STHT018-32T	13.12
9/32	40	BOTTOM	STHT018-40B	13.12
9/32	40	PLUG	STHT018-40P	13.12
9/32	40	TAPER	STHT018-40T	13.12

SIZE	T.P.I.	CHAMFER	ITEM NO.	PRICE
5/16	20	BOTTOM	STHT020-20B	10.42
5/16	20	PLUG	STHT020-20P	10.42
5/16	20	TAPER	STHT020-20T	10.42
5/16	22	BOTTOM	STHT020-22B	10.42
5/16	22	PLUG	STHT020-22P	10.42
5/16	22	TAPER	STHT020-22T	10.42
5/16	27	PLUG	STHT020-27P	CALL
5/16	32	BOTTOM	STHT020-32B	10.42
5/16	32	PLUG	STHT020-32P	10.42
5/16	32	TAPER	STHT020-32T	10.42
5/16	36	BOTTOM	STHT020-36B	10.42
5/16	36	PLUG	STHT020-36P	10.42
5/16	36	TAPER	STHT020-36T	10.42
5/16	40	BOTTOM	STHT020-40B	10.42
5/16	40	PLUG	STHT020-40P	10.42
5/16	40	TAPER	STHT020-40T	10.42
11/32	32	BOTTOM	STHT022-32B	10.42
11/32	32	PLUG	STHT022-32P	10.42
11/32	32	TAPER	STHT022-32T	10.42
3/8	14	BOTTOM	STHT024-14B	9.44
3/8	14	PLUG	STHT024-14P	9.44
3/8	14	TAPER	STHT024-14T	9.44
3/8	18	BOTTOM	STHT024-18B	9.44
3/8	18	PLUG	STHT024-18P	9.44
3/8	18	TAPER	STHT024-18T	9.44
3/8	20	BOTTOM	STHT024-20B	9.44
3/8	20	PLUG	STHT024-20P	9.44
3/8	20	TAPER	STHT024-20T	9.44
3/8	28	BOTTOM	STHT024-28B	9.44
3/8	28	PLUG	STHT024-28P	9.44
3/8	28	TAPER	STHT024-28T	9.44
3/8	32	BOTTOM	STHT024-32B	9.44
3/8	32	PLUG	STHT024-32P	9.44
3/8	32	TAPER	STHT024-32T	9.44
7/16	24	BOTTOM	STHT028-24B	14.24
7/16	24	PLUG	STHT028-24P	14.24
7/16	24	TAPER	STHT028-24T	14.24
7/16	27	BOTTOM	STHT028-27B	14.24
7/16	27	PLUG	STHT028-27P	14.24
7/16	27	TAPER	STHT028-27T	14.24
7/16	28	BOTTOM	STHT028-28B	14.24
7/16	28	PLUG	STHT028-28P	14.24
7/16	28	TAPER	STHT028-28T	14.24
7/16	32	BOTTOM	STHT028-32B	14.24
7/16	32	PLUG	STHT028-32P	14.24
7/16	32	TAPER	STHT028-32T	14.24
7/16	40	BOTTOM	STHT028-40B	CALL
7/16	40	PLUG	STHT028-40P	FOR
7/16	40	TAPER	STHT028-40T	PRICE
15/32	32	BOTTOM	STHT030-32B	18.20
15/32	32	PLUG	STHT030-32P	18.20
15/32	32	TAPER	STHT030-32T	18.20
1/2	12	BOTTOM	STHT032-12B	18.20
1/2	12	PLUG	STHT032-12P	18.20
1/2	12	TAPER	STHT032-12T	18.20
1/2	14	BOTTOM	STHT032-14B	18.20
1/2	14	PLUG	STHT032-14P	18.20
1/2	14	TAPER	STHT032-14T	18.20
1/2	16	BOTTOM	STHT032-16B	18.20
1/2	16	PLUG	STHT032-16P	18.20
1/2	16	TAPER	STHT032-16T	18.20
1/2	18	BOTTOM	STHT032-18B	18.20
1/2	18	PLUG	STHT032-18P	18.20
1/2	18	TAPER	STHT032-18T	18.20
1/2	24	BOTTOM	STHT032-24B	18.20
1/2	24	PLUG	STHT032-24P	18.20
1/2	24	TAPER	STHT032-24T	18.20
1/2	27	BOTTOM	STHT032-27B	18.20
1/2	27	PLUG	STHT032-27P	18.20
1/2	27	TAPER	STHT032-27T	18.20
1/2	28	BOTTOM	STHT032-28B	18.20
1/2	28	PLUG	STHT032-28P	18.20
1/2	28	TAPER	STHT032-28T	18.20
1/2	32	BOTTOM	STHT032-32B	18.20
1/2	32	PLUG	STHT032-32P	18.20

SIZE	T.P.I.	CHAMFER	ITEM NO.	PRICE
1/2	32	TAPER	STHT032-32T	18.20
1/2	40	BOTTOM	STHT032-40B	18.20
1/2	40	PLUG	STHT032-40P	18.20
1/2	40	TAPER	STHT032-40T	18.20
9/16	16	BOTTOM	STHT036-16B	21.84
9/16	16	PLUG	STHT036-16P	21.84
9/16	16	TAPER	STHT036-16T	21.84
9/16	20	BOTTOM	STHT036-20B	21.84
9/16	20	PLUG	STHT036-20P	21.84
9/16	20	TAPER	STHT036-20T	21.84
9/16	24	BOTTOM	STHT036-24B	21.84
9/16	24	PLUG	STHT036-24P	21.84
9/16	24	TAPER	STHT036-24T	21.84
9/16	27	BOTTOM	STHT036-27B	21.84
9/16	27	PLUG	STHT036-27P	21.84
9/16	27	TAPER	STHT036-27T	21.84
9/16	28	BOTTOM	STHT036-28B	21.84
9/16	28	PLUG	STHT036-28P	21.84
9/16	28	TAPER	STHT036-28T	21.84
9/16	30	BOTTOM	STHT036-30B	21.84
9/16	30	PLUG	STHT036-30P	21.84
9/16	30	TAPER	STHT036-30T	21.84
9/16	32	BOTTOM	STHT036-32B	21.84
9/16	32	PLUG	STHT036-32P	21.84
9/16	32	TAPER	STHT036-32T	21.84
9/16	40	BOTTOM	STHT036-40B	21.84
9/16	40	PLUG	STHT036-40P	21.84
9/16	40	TAPER	STHT036-40T	21.84
5/8	12	BOTTOM	STHT040-12B	25.52
5/8	12	PLUG	STHT040-12P	25.52
5/8	12	TAPER	STHT040-12T	25.52
5/8	14	BOTTOM	STHT040-14B	25.52
5/8	14	PLUG	STHT040-14P	25.52
5/8	14	TAPER	STHT040-14T	25.52
5/8	16	BOTTOM	STHT040-16B	25.52
5/8	16	PLUG	STHT040-16P	25.52
5/8	16	TAPER	STHT040-16T	25.52
5/8	20	BOTTOM	STHT040-20B	25.52
5/8	20	PLUG	STHT040-20P	25.52
5/8	20	TAPER	STHT040-20T	25.52
5/8	24	BOTTOM	STHT040-24B	25.52
5/8	24	PLUG	STHT040-24P	25.52
5/8	24	TAPER	STHT040-24T	25.52
5/8	26	BOTTOM	STHT040-26B	25.52
5/8	26	PLUG	STHT040-26P	25.52
5/8	26	TAPER	STHT040-26T	25.52
5/8	27	BOTTOM	STHT040-27B	25.52
5/8	27	PLUG	STHT040-27P	25.52
5/8	27	TAPER	STHT040-27T	25.52
5/8	28	BOTTOM	STHT040-28B	25.52
5/8	28	PLUG	STHT040-28P	25.52
5/8	28	TAPER	STHT040-28T	25.52
5/8	32	BOTTOM	STHT040-32B	25.52
5/8	32	PLUG	STHT040-32P	25.52
5/8	32	TAPER	STHT040-32T	25.52
5/8	36	PLUG	STHT040-36P	25.52
5/8	36	TAPER	STHT040-36T	25.52
5/8	40	BOTTOM	STHT040-40B	25.52
5/8	40	PLUG	STHT040-40P	25.52
5/8	40	TAPER	STHT040-40T	25.52
11/16	12	BOTTOM	STHT044-12B	35.18
11/16	12	PLUG	STHT044-12P	35.18
11/16	12	TAPER	STHT044-12T	35.18
11/16	18	BOTTOM	STHT044-18B	35.18
11/16	18	PLUG	STHT044-18P	35.18
11/16	18	TAPER	STHT044-18T	35.18
11/16	20	BOTTOM	STHT044-20B	35.18
11/16	20	PLUG	STHT044-20P	35.18
11/16	20	TAPER	STHT044-20T	35.18
11/16	24	BOTTOM	STHT044-24B	35.18
11/16	24	PLUG	STHT044-24P	35.18
11/16	24	TAPER	STHT044-24T	35.18
11/16	27	BOTTOM	STHT044-27B	35.18
11/16	27	PLUG	STHT044-27P	35.18

HIGH SPEED STEEL SPECIAL THREAD HAND TAPS

ICS **WIS**

SPECIAL PURPOSE

GROUND THREAD

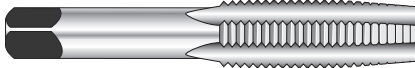

TAPER TAP (T)
7-10 Thread Chamfer
at 5 degrees per side

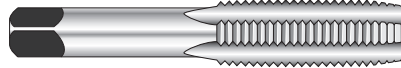

PLUG TAP (P)
3-5 Thread Chamfer
at 8 degrees per side

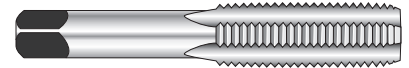

BOTTOMING TAP (B)
1-2 Thread Chamfer
at 18 degrees per side

SIZES 11/16" - 27 to 1-3/8" - 14

SIZE	T.P.I.	CHAMFER	ITEM NO.	PRICE
11/16	27	TAPER	STHT044-27T	35.18
11/16	32	BOTTOM	STHT044-32B	35.18
11/16	32	PLUG	STHT044-32P	35.18
11/16	32	TAPER	STHT044-32T	35.18
3/4	11-1/2	BOTTOM	STHT048-11.5B	CALL
3/4	12	BOTTOM	STHT048-12B	42.48
3/4	12	PLUG	STHT048-12P	42.48
3/4	12	TAPER	STHT048-12T	42.48
3/4	14	BOTTOM	STHT048-14B	42.48
3/4	14	PLUG	STHT048-14P	42.48
3/4	14	TAPER	STHT048-14T	42.48
3/4	18	BOTTOM	STHT048-18B	42.48
3/4	18	PLUG	STHT048-18P	42.48
3/4	18	TAPER	STHT048-18T	42.48
3/4	20	BOTTOM	STHT048-20B	42.48
3/4	20	PLUG	STHT048-20P	42.48
3/4	20	TAPER	STHT048-20T	42.48
3/4	24	BOTTOM	STHT048-24B	42.48
3/4	24	PLUG	STHT048-24P	42.48
3/4	24	TAPER	STHT048-24T	42.48
3/4	26	BOTTOM	STHT048-26B	42.48
3/4	26	PLUG	STHT048-26P	42.48
3/4	26	TAPER	STHT048-26T	42.48
3/4	27	BOTTOM	STHT048-27B	42.48
3/4	27	PLUG	STHT048-27P	42.48
3/4	27	TAPER	STHT048-27T	42.48
3/4	28	BOTTOM	STHT048-28B	42.48
3/4	28	PLUG	STHT048-28P	42.48
3/4	28	TAPER	STHT048-28T	42.48
3/4	32	BOTTOM	STHT048-32B	42.48
3/4	32	PLUG	STHT048-32P	42.48
3/4	32	TAPER	STHT048-32T	42.48
3/4	36	BOTTOM	STHT048-36B	42.48
3/4	36	PLUG	STHT048-36P	42.48
3/4	36	TAPER	STHT048-36T	42.48
13/16	12	BOTTOM	STHT052-12B	52.18
13/16	12	PLUG	STHT052-12P	52.18
13/16	12	TAPER	STHT052-12T	52.18
13/16	14	BOTTOM	STHT052-14B	52.18
13/16	14	PLUG	STHT052-14P	52.18
13/16	14	TAPER	STHT052-14T	52.18
13/16	16	BOTTOM	STHT052-16B	52.18
13/16	16	PLUG	STHT052-16P	52.18
13/16	16	TAPER	STHT052-16T	52.18
13/16	18	BOTTOM	STHT052-18B	52.18
13/16	18	PLUG	STHT052-18P	52.18
13/16	18	TAPER	STHT052-18T	52.18
13/16	20	BOTTOM	STHT052-20B	52.18
13/16	20	PLUG	STHT052-20P	52.18
13/16	20	TAPER	STHT052-20T	52.18
13/16	24	BOTTOM	STHT052-24B	52.18
13/16	24	PLUG	STHT052-24P	52.18
13/16	24	TAPER	STHT052-24T	52.18
13/16	26	BOTTOM	STHT052-26B	52.18
13/16	26	PLUG	STHT052-26P	52.18
13/16	26	TAPER	STHT052-26T	52.18
13/16	28	BOTTOM	STHT052-28B	52.18
13/16	28	PLUG	STHT052-28P	52.18
13/16	28	TAPER	STHT052-28T	52.18
13/16	32	BOTTOM	STHT052-32B	52.18
13/16	32	PLUG	STHT052-32P	52.18
13/16	32	TAPER	STHT052-32T	52.18
13/16	36	BOTTOM	STHT052-36B	52.18
13/16	36	PLUG	STHT052-36P	52.18
13/16	36	TAPER	STHT052-36T	52.18
7/8	12	BOTTOM	STHT056-12B	60.70
7/8	12	PLUG	STHT056-12P	60.70
7/8	12	TAPER	STHT056-12T	60.70
7/8	16	BOTTOM	STHT056-16B	60.70
7/8	16	PLUG	STHT056-16P	60.70
7/8	16	TAPER	STHT056-16T	60.70
7/8	18	BOTTOM	STHT056-18B	60.70
7/8	18	PLUG	STHT056-18P	60.70
7/8	18	TAPER	STHT056-18T	60.70
7/8	20	BOTTOM	STHT056-20B	60.70

SIZE	T.P.I.	CHAMFER	ITEM NO.	PRICE
7/8	20	PLUG	STHT056-20P	60.70
7/8	20	TAPER	STHT056-20T	60.70
7/8	24	BOTTOM	STHT056-24B	60.70
7/8	24	PLUG	STHT056-24P	60.70
7/8	24	TAPER	STHT056-24T	60.70
7/8	27	BOTTOM	STHT056-27B	60.70
7/8	27	PLUG	STHT056-27P	60.70
7/8	27	TAPER	STHT056-27T	60.70
7/8	32	BOTTOM	STHT056-32B	60.70
7/8	32	PLUG	STHT056-32P	60.70
7/8	32	TAPER	STHT056-32T	60.70
7/8	40	BOTTOM	STHT056-40B	60.70
7/8	40	PLUG	STHT056-40P	60.70
7/8	40	TAPER	STHT056-40T	60.70
15/16	12	BOTTOM	STHT060-12B	64.32
15/16	12	PLUG	STHT060-12P	64.32
15/16	12	TAPER	STHT060-12T	64.32
15/16	14	BOTTOM	STHT060-14B	CALL
15/16	14	PLUG	STHT060-14P	FOR
15/16	14	TAPER	STHT060-14T	PRICE
15/16	16	BOTTOM	STHT060-16B	64.32
15/16	16	PLUG	STHT060-16P	64.32
15/16	16	TAPER	STHT060-16T	64.32
15/16	18	BOTTOM	STHT060-18B	64.32
15/16	18	PLUG	STHT060-18P	64.32
15/16	18	TAPER	STHT060-18T	64.32
15/16	20	BOTTOM	STHT060-20B	64.32
15/16	20	PLUG	STHT060-20P	64.32
15/16	20	TAPER	STHT060-20T	64.32
15/16	24	BOTTOM	STHT060-24B	64.32
15/16	24	PLUG	STHT060-24P	64.32
15/16	24	TAPER	STHT060-24T	64.32
15/16	27	BOTTOM	STHT060-27B	64.32
15/16	27	PLUG	STHT060-27P	64.32
15/16	27	TAPER	STHT060-27T	64.32
15/16	32	BOTTOM	STHT060-32B	64.32
15/16	32	PLUG	STHT060-32P	64.32
15/16	32	TAPER	STHT060-32T	64.32
1	16	BOTTOM	STHT100-16B	78.88
1	16	PLUG	STHT100-16P	78.88
1	16	TAPER	STHT100-16T	78.88
1	18	BOTTOM	STHT100-18B	78.88
1	18	PLUG	STHT100-18P	78.88
1	18	TAPER	STHT100-18T	78.88
1	20	BOTTOM	STHT100-20B	78.88
1	20	PLUG	STHT100-20P	78.88
1	20	TAPER	STHT100-20T	78.88
1	24	BOTTOM	STHT100-24B	78.88
1	24	PLUG	STHT100-24P	78.88
1	24	TAPER	STHT100-24T	78.88
1	26	BOTTOM	STHT100-26B	78.88
1	26	PLUG	STHT100-26P	78.88
1	26	TAPER	STHT100-26T	78.88
1	27	BOTTOM	STHT100-27B	78.88
1	27	PLUG	STHT100-27P	78.88
1	27	TAPER	STHT100-27T	78.88
1	28	BOTTOM	STHT100-28B	78.88
1	28	PLUG	STHT100-28P	78.88
1	28	TAPER	STHT100-28T	78.88
1	32	BOTTOM	STHT100-32B	78.88
1	32	PLUG	STHT100-32P	78.88
1	32	TAPER	STHT100-32T	78.88
1	36	BOTTOM	STHT100-36B	78.88
1	36	PLUG	STHT100-36P	78.88
1	36	TAPER	STHT100-36T	78.88
1	40	BOTTOM	STHT100-40B	78.88
1	40	PLUG	STHT100-40P	78.88
1	40	TAPER	STHT100-40T	78.88
1-1/16	12	BOTTOM	STHT104-12B	89.60
1-1/16	12	PLUG	STHT104-12P	89.60
1-1/16	12	TAPER	STHT104-12T	89.60
1-1/8	14	BOTTOM	STHT108-14B	103.18
1-1/8	14	PLUG	STHT108-14P	103.18
1-1/8	14	TAPER	STHT108-14T	103.18
1-1/8	16	BOTTOM	STHT108-16B	103.18

SIZE	T.P.I.	CHAMFER	ITEM NO.	PRICE
1-1/8	16	PLUG	STHT108-16P	103.18
1-1/8	16	TAPER	STHT108-16T	103.18
1-1/8	18	BOTTOM	STHT108-18B	103.18
1-1/8	18	PLUG	STHT108-18P	103.18
1-1/8	18	TAPER	STHT108-18T	103.18
1-1/8	20	BOTTOM	STHT108-20B	103.18
1-1/8	20	PLUG	STHT108-20P	103.18
1-1/8	20	TAPER	STHT108-20T	103.18
1-1/8	24	BOTTOM	STHT108-24B	103.18
1-1/8	24	PLUG	STHT108-24P	103.18
1-1/8	24	TAPER	STHT108-24T	103.18
1-1/8	27	BOTTOM	STHT108-27B	103.18
1-1/8	27	PLUG	STHT108-27P	103.18
1-1/8	27	TAPER	STHT108-27T	103.18
1-1/8	32	BOTTOM	STHT108-32B	103.18
1-1/8	32	PLUG	STHT108-32P	103.18
1-1/8	32	TAPER	STHT108-32T	103.18
1-3/16	12	BOTTOM	STHT112-12B	113.82
1-3/16	12	PLUG	STHT112-12P	113.82
1-3/16	12	TAPER	STHT112-12T	113.82
1-3/16	14	BOTTOM	STHT112-14B	113.82
1-3/16	14	PLUG	STHT112-14P	113.82
1-3/16	14	TAPER	STHT112-14T	113.82
1-3/16	16	BOTTOM	STHT112-16B	113.82
1-3/16	16	PLUG	STHT112-16P	113.82
1-3/16	16	TAPER	STHT112-16T	113.82
1-3/16	18	BOTTOM	STHT112-18B	113.82
1-3/16	18	PLUG	STHT112-18P	113.82
1-3/16	18	TAPER	STHT112-18T	113.82
1-3/16	20	BOTTOM	STHT112-20B	113.82
1-3/16	20	PLUG	STHT112-20P	113.82
1-3/16	20	TAPER	STHT112-20T	113.82
1-3/16	24	BOTTOM	STHT112-24B	113.82
1-3/16	24	PLUG	STHT112-24P	113.82
1-3/16	24	TAPER	STHT112-24T	113.82
1-3/16	32	BOTTOM	STHT112-32B	113.82
1-3/16	32	PLUG	STHT112-32P	113.82
1-3/16	32	TAPER	STHT112-32T	113.82
1-1/4	14	BOTTOM	STHT116-14B	132.20
1-1/4	14	PLUG	STHT116-14P	132.20
1-1/4	14	TAPER	STHT116-14T	132.20
1-1/4	16	BOTTOM	STHT116-16B	132.20
1-1/4	16	PLUG	STHT116-16P	132.20
1-1/4	16	TAPER	STHT116-16T	132.20
1-1/4	18	BOTTOM	STHT116-18B	132.20
1-1/4	18	PLUG	STHT116-18P	132.20
1-1/4	18	TAPER	STHT116-18T	132.20
1-1/4	20	BOTTOM	STHT116-20B	132.20
1-1/4	20	PLUG	STHT116-20P	132.20
1-1/4	20	TAPER	STHT116-20T	132.20
1-1/4	24	BOTTOM	STHT116-24B	132.20
1-1/4	24	PLUG	STHT116-24P	132.20
1-1/4	24	TAPER	STHT116-24T	132.20
1-1/4	26	BOTTOM	STHT116-26B	132.20
1-1/4	26	PLUG	STHT116-26P	132.20
1-1/4	26	TAPER	STHT116-26T	132.20
1-1/4	32	BOTTOM	STHT116-32B	132.20
1-1/4	32	PLUG	STHT116-32P	132.20
1-1/4	32	TAPER	STHT116-32T	132.20
1-5/16	12	BOTTOM	STHT120-12B	167.74
1-5/16	12	PLUG	STHT120-12P	167.74
1-5/16	12	TAPER	STHT120-12T	167.74
1-5/16	14	BOTTOM	STHT120-14B	167.74
1-5/16	14	PLUG	STHT120-14P	167.74
1-5/16	14	TAPER	STHT120-14T	167.74
1-5/16	16	BOTTOM	STHT120-16B	167.74
1-5/16	16	PLUG	STHT120-16P	167.74
1-5/16	16	TAPER	STHT120-16T	167.74
1-5/16	18	BOTTOM	STHT120-18B	167.74
1-5/16	18	PLUG	STHT120-18P	167.74
1-5/16	18	TAPER	STHT120-18T	167.74

HIGH SPEED STEEL SPECIAL THREAD HAND TAPS

ICS WIS

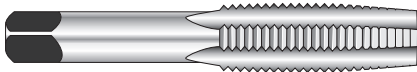

TAPER TAP (T)
7-10 Thread Chamfer
at 5 degrees per side

SPECIAL PURPOSE

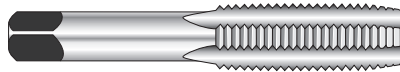

PLUG TAP (P)
3-5 Thread Chamfer
at 8 degrees per side

GROUND THREAD

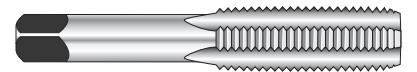

BOTTOMING TAP (B)
1-2 Thread Chamfer
at 18 degrees per side

SIZES 1-3/8" - 14 to 4" - 12

SIZE	T.P.I.	CHAMFER	ITEM NO.	PRICE
1-3/8	14	PLUG	STHT124-14P	167.74
1-3/8	14	TAPER	STHT124-14T	167.74
1-3/8	16	BOTTOM	STHT124-16B	167.74
1-3/8	16	PLUG	STHT124-16P	167.74
1-3/8	16	TAPER	STHT124-16T	167.74
1-3/8	18	BOTTOM	STHT124-18B	167.74
1-3/8	18	PLUG	STHT124-18P	167.74
1-3/8	18	TAPER	STHT124-18T	167.74
1-3/8	20	BOTTOM	STHT124-20B	167.74
1-3/8	20	PLUG	STHT124-20P	167.74
1-3/8	20	TAPER	STHT124-20T	167.74
1-3/8	24	BOTTOM	STHT124-24B	167.74
1-3/8	24	PLUG	STHT124-24P	167.74
1-3/8	24	TAPER	STHT124-24T	167.74
1-7/16	12	BOTTOM	STHT128-12B	194.20
1-7/16	12	PLUG	STHT128-12P	194.20
1-7/16	12	TAPER	STHT128-12T	194.20
1-7/16	16	BOTTOM	STHT128-16B	194.20
1-7/16	16	PLUG	STHT128-16P	194.20
1-7/16	16	TAPER	STHT128-16T	194.20
1-7/16	18	BOTTOM	STHT128-18B	194.20
1-7/16	18	PLUG	STHT128-18P	194.20
1-7/16	18	TAPER	STHT128-18T	194.20
1-7/16	20	BOTTOM	STHT128-20B	194.20
1-7/16	20	PLUG	STHT128-20P	194.20
1-7/16	20	TAPER	STHT128-20T	194.20
1-1/2	14	BOTTOM	STHT132-14B	192.84
1-1/2	14	PLUG	STHT132-14P	192.84
1-1/2	14	TAPER	STHT132-14T	192.84
1-1/2	16	BOTTOM	STHT132-16B	192.84
1-1/2	16	PLUG	STHT132-16P	192.84
1-1/2	16	TAPER	STHT132-16T	192.84
1-1/2	18	BOTTOM	STHT132-18B	192.84
1-1/2	18	PLUG	STHT132-18P	192.84
1-1/2	18	TAPER	STHT132-18T	192.84
1-1/2	20	BOTTOM	STHT132-20B	192.84
1-1/2	20	PLUG	STHT132-20P	192.84
1-1/2	20	TAPER	STHT132-20T	192.84
1-1/2	24	BOTTOM	STHT132-24B	192.84
1-1/2	24	PLUG	STHT132-24P	192.84
1-1/2	24	TAPER	STHT132-24T	192.84
1-1/2	32	BOTTOM	STHT132-32B	192.84
1-1/2	32	PLUG	STHT132-32P	192.84
1-1/2	32	TAPER	STHT132-32T	192.84
1-9/16	12	BOTTOM	STHT136-12B	226.62
1-9/16	12	PLUG	STHT136-12P	226.62
1-9/16	12	TAPER	STHT136-12T	226.62
1-9/16	16	BOTTOM	STHT136-16B	226.62
1-9/16	16	PLUG	STHT136-16P	226.62
1-9/16	16	TAPER	STHT136-16T	226.62
1-9/16	18	BOTTOM	STHT136-18B	226.62
1-9/16	18	PLUG	STHT136-18P	226.62
1-9/16	18	TAPER	STHT136-18T	226.62
1-9/16	20	BOTTOM	STHT136-20B	262.22
1-9/16	20	PLUG	STHT136-20P	262.22
1-9/16	20	TAPER	STHT136-20T	262.22
1-5/8	5-1/2	BOTTOM	STHT140-05.5B	221.44
1-5/8	5-1/2	PLUG	STHT140-05.5P	221.44
1-5/8	5-1/2	TAPER	STHT140-05.5T	221.44
1-5/8	12	BOTTOM	STHT140-12B	293.16
1-5/8	12	PLUG	STHT140-12P	293.16
1-5/8	12	TAPER	STHT140-12T	293.16
1-5/8	16	BOTTOM	STHT140-16B	221.44
1-5/8	16	PLUG	STHT140-16P	221.44
1-5/8	16	TAPER	STHT140-16T	221.44
1-5/8	18	BOTTOM	STHT140-18B	221.44
1-5/8	18	PLUG	STHT140-18P	221.44
1-5/8	18	TAPER	STHT140-18T	221.44
1-11/16	12	BOTTOM	STHT144-12B	285.28
1-11/16	12	PLUG	STHT144-12P	285.28
1-11/16	12	TAPER	STHT144-12T	285.28
1-11/16	16	BOTTOM	STHT144-16B	285.28
1-11/16	16	PLUG	STHT144-16P	285.28
1-11/16	16	TAPER	STHT144-16T	285.28
1-11/16	18	BOTTOM	STHT144-18B	285.28

SIZE	T.P.I.	CHAMFER	ITEM NO.	PRICE
1-11/16	18	PLUG	STHT144-18P	285.28
1-11/16	18	TAPER	STHT144-18T	285.28
1-11/16	20	BOTTOM	STHT144-20B	285.28
1-11/16	20	PLUG	STHT144-20P	285.28
1-11/16	20	TAPER	STHT144-20T	285.28
1-3/4	6	BOTTOM	STHT148-06B	285.36
1-3/4	6	PLUG	STHT148-06P	285.36
1-3/4	6	TAPER	STHT148-06T	285.36
1-3/4	12	BOTTOM	STHT148-12B	285.36
1-3/4	12	PLUG	STHT148-12P	285.36
1-3/4	12	TAPER	STHT148-12T	285.36
1-3/4	14	BOTTOM	STHT148-14B	285.36
1-3/4	14	PLUG	STHT148-14P	285.36
1-3/4	14	TAPER	STHT148-14T	285.36
1-3/4	16	BOTTOM	STHT148-16B	285.36
1-3/4	16	PLUG	STHT148-16P	285.36
1-3/4	16	TAPER	STHT148-16T	285.36
1-3/4	18	BOTTOM	STHT148-18B	285.36
1-3/4	18	PLUG	STHT148-18P	285.36
1-3/4	18	TAPER	STHT148-18T	285.36
1-3/4	20	BOTTOM	STHT148-20B	285.36
1-3/4	20	PLUG	STHT148-20P	285.36
1-3/4	20	TAPER	STHT148-20T	285.36
1-3/4	24	BOTTOM	STHT148-24B	285.36
1-3/4	24	PLUG	STHT148-24P	285.36
1-3/4	24	TAPER	STHT148-24T	285.36
1-13/16	16	BOTTOM	STHT152-16B	214.58
1-13/16	16	PLUG	STHT152-16P	214.58
1-13/16	16	TAPER	STHT152-16T	214.58
1-7/8	5	BOTTOM	STHT156-05B	390.62
1-7/8	5	PLUG	STHT156-05P	390.62
1-7/8	5	TAPER	STHT156-05T	390.62
1-7/8	12	BOTTOM	STHT156-12B	390.62
1-7/8	12	PLUG	STHT156-12P	390.62
1-7/8	12	TAPER	STHT156-12T	390.62
1-7/8	16	BOTTOM	STHT156-16B	390.62
1-7/8	16	PLUG	STHT156-16P	390.62
1-7/8	16	TAPER	STHT156-16T	390.62
1-7/8	18	BOTTOM	STHT156-18B	390.62
1-7/8	18	PLUG	STHT156-18P	390.62
1-7/8	18	TAPER	STHT156-18T	390.62
1-7/8	20	BOTTOM	STHT156-20B	390.62
1-7/8	20	PLUG	STHT156-20P	390.62
1-7/8	20	TAPER	STHT156-20T	390.62
1-15/16	12	BOTTOM	STHT160-12B	390.62
1-15/16	12	PLUG	STHT160-12P	390.62
1-15/16	12	TAPER	STHT160-12T	390.62
1-15/16	16	BOTTOM	STHT160-16B	390.62
1-15/16	16	PLUG	STHT160-16P	390.62
1-15/16	16	TAPER	STHT160-16T	390.62
1-15/16	18	BOTTOM	STHT160-18B	390.62
1-15/16	18	PLUG	STHT160-18P	390.62
1-15/16	18	TAPER	STHT160-18T	390.62
2	6	BOTTOM	STHT200-06B	394.28
2	6	PLUG	STHT200-06P	394.28
2	6	TAPER	STHT200-06T	394.28
2	12	BOTTOM	STHT200-12B	394.28
2	12	PLUG	STHT200-12P	394.28
2	12	TAPER	STHT200-12T	394.28
2	14	BOTTOM	STHT200-14B	394.28
2	14	PLUG	STHT200-14P	394.28
2	14	TAPER	STHT200-14T	394.28
2	16	BOTTOM	STHT200-16B	394.28
2	16	PLUG	STHT200-16P	394.28
2	16	TAPER	STHT200-16T	394.28
2	18	BOTTOM	STHT200-18B	394.28
2	18	PLUG	STHT200-18P	394.28
2	18	TAPER	STHT200-18T	394.28
2	20	BOTTOM	STHT200-20B	394.28
2	20	PLUG	STHT200-20P	394.28
2	20	TAPER	STHT200-20T	394.28
2-1/16	12	BOTTOM	STHT204-12B	CALL FOR PRICE
2-1/16	12	PLUG	STHT204-12P	CALL FOR PRICE
2-1/16	12	TAPER	STHT204-12T	CALL FOR PRICE
2-1/8	12	BOTTOM	STHT208-12B	402.72

SIZE	T.P.I.	CHAMFER	ITEM NO.	PRICE
2-1/8	12	PLUG	STHT208-12P	402.72
2-1/8	12	TAPER	STHT208-12T	402.72
2-1/4	12	BOTTOM	STHT216-12B	527.68
2-1/4	12	PLUG	STHT216-12P	527.68
2-1/4	12	TAPER	STHT216-12T	527.68
2-1/4	14	BOTTOM	STHT216-14B	-
2-1/4	14	PLUG	STHT216-14P	-
2-1/4	14	TAPER	STHT216-14T	-
2-1/4	16	BOTTOM	STHT216-16B	-
2-1/4	16	PLUG	STHT216-16P	-
2-1/4	16	TAPER	STHT216-16T	-
2-1/4	18	BOTTOM	STHT216-18B	-
2-1/4	18	PLUG	STHT216-18P	CALL FOR PRICE
2-1/4	18	TAPER	STHT216-18T	CALL FOR PRICE
2-5/16	14	BOTTOM	STHT220-14B	-
2-5/16	14	PLUG	STHT220-14P	-
2-5/16	14	TAPER	STHT220-14T	-
2-5/16	16	BOTTOM	STHT220-16B	-
2-5/16	16	PLUG	STHT220-16P	-
2-5/16	16	TAPER	STHT220-16T	-
2-5/16	18	BOTTOM	STHT220-18B	-
2-5/16	18	PLUG	STHT220-18P	-
2-5/16	18	TAPER	STHT220-18T	-
2-3/8	12	BOTTOM	STHT224-12B	527.68
2-3/8	12	PLUG	STHT224-12P	527.68
2-3/8	12	TAPER	STHT224-12T	527.68
2-3/8	16	BOTTOM	STHT224-16B	527.68
2-3/8	16	PLUG	STHT224-16P	527.68
2-3/8	16	TAPER	STHT224-16T	527.68
2-3/8	18	BOTTOM	STHT224-18B	527.68
2-3/8	18	PLUG	STHT224-18P	527.68
2-3/8	18	TAPER	STHT224-18T	527.68
2-1/2	12	BOTTOM	STHT232-12B	775.96
2-1/2	12	PLUG	STHT232-12P	775.96
2-1/2	12	TAPER	STHT232-12T	775.96
2-1/2	16	BOTTOM	STHT232-16B	775.96
2-1/2	16	PLUG	STHT232-16P	775.96
2-1/2	16	TAPER	STHT232-16T	775.96
2-5/8	12	BOTTOM	STHT240-12B	-
2-5/8	12	PLUG	STHT240-12P	-
2-5/8	12	TAPER	STHT240-12T	-
2-5/8	16	BOTTOM	STHT240-16B	-
2-5/8	16	PLUG	STHT240-16P	-
2-5/8	16	TAPER	STHT240-16T	-
2-3/4	12	BOTTOM	STHT248-12B	CALL FOR PRICE
2-3/4	12	PLUG	STHT248-12P	CALL FOR PRICE
2-3/4	12	TAPER	STHT248-12T	CALL FOR PRICE
2-3/4	16	BOTTOM	STHT248-16B	-
2-3/4	16	PLUG	STHT248-16P	-
2-3/4	16	TAPER	STHT248-16T	-
2-7/8	12	BOTTOM	STHT256-12B	-
2-7/8	12	PLUG	STHT256-12P	-
2-7/8	12	TAPER	STHT256-12T	-
3	12	BOTTOM	STHT300-12B	966.00
3	12	PLUG	STHT300-12P	966.00
3	12	TAPER	STHT300-12T	966.00
3	16	BOTTOM	STHT300-16B	966.00
3	16	PLUG	STHT300-16P	966.00
3	16	TAPER	STHT300-16T	966.00
3	18	BOTTOM	STHT300-18B	966.00
3	18	PLUG	STHT300-18P	966.00
3	18	TAPER	STHT300-18T	966.00
3-1/8	12	BOTTOM	STHT308-12B	-
3-1/8	12	PLUG	STHT308-12P	-
3-1/8	12	TAPER	STHT308-12T	-
3-1/4	12	BOTTOM	STHT316-12B	-
3-1/4	12	PLUG	STHT316-12P	-
3-1/4	12	TAPER	STHT316-12T	CALL FOR PRICE
3-1/2	12	BOTTOM	STHT332-12B	-
3-1/2	12			

HIGH SPEED STEEL METRIC THREAD HAND TAPS

ICS **WIS**

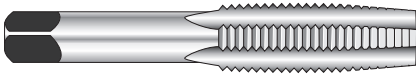

TAPER TAP (T)
7-10 Thread Chamfer
at 5 degrees per side

GENERAL PURPOSE

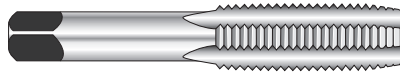

PLUG TAP (P)
3-5 Thread Chamfer
at 8 degrees per side

GROUND THREAD

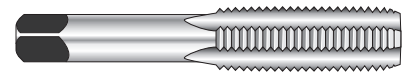

BOTTOMING TAP (B)
1-2 Thread Chamfer
at 18 degrees per side

High Speed Steel Metric Thread Hand Taps with straight flutes are designed for general purpose hand tapping or in production machines where ground thread accuracy and performance are required. They are suitable for tapping most materials in through or blind holes. Hand taps retain chips in the flutes during use and work best on materials that produce chips and the swarf breaks easily. They are also known as Straight Flute Taps.

SIZE mm	PITCH mm	NO. OF FLUTES	PRICE		TAP DRILL SIZES mm
			TAPER, PLUG or BOTTOM	TAPER, PLUG & BOTTOM (3 PC SET)	
			SHTM	SHTMS	
M1.5	0.35	2	15.48	46.44	M1.15
M1.6	0.35	2	15.48	46.44	M1.25
M1.8	0.35	2	15.48	46.44	M1.45
M2	0.40	3	12.42	37.26	M1.60
M2	0.45	3	10.50	31.50	M2.05
M2.2	0.45	3	10.50	31.50	M1.75
M2.3	0.40	3	10.50	31.50	M1.90
M2.5	0.45	3	10.50	31.50	M2.05
M2.6	0.45	3	10.50	31.50	M2.20
M3	0.50	3	7.78	23.34	M2.50
M3	0.60	3	8.60	25.80	M2.40
M3.5	0.60	3	8.60	25.80	M2.90
M4	0.70	4	6.82	20.46	M3.30
M4	0.50	4	7.88	23.64	M3.50
M4.5	0.75	4	8.60	25.80	M3.70
M5	0.80	4	6.82	20.46	M4.20
M5	0.90	4	6.82	20.46	M4.10
M5.5	0.90	4	6.82	20.46	M4.60
M6	1.00	4	6.62	19.86	M5.00
M6.3	1.00	4	7.04	21.12	M5.30
M7	1.00	4	7.18	21.54	M6.00
M8	1.25	4	7.32	21.96	M6.80
M8	1.00	4	7.90	23.70	M7.00
M9	1.25	4	9.30	27.90	M7.80
M10	1.50	4	9.30	27.90	M8.50
M10	1.25	4	10.26	30.78	M8.80
M10	1.00	4	10.26	30.78	M9.00
M11	1.50	4	10.26	30.78	M9.50
M12	1.75	4	15.18	45.54	M10.20
M12	1.50	4	16.72	50.16	M10.50
M12	1.25	4	16.72	50.16	M10.80
M14	2.00	4	23.68	71.04	M12.00
M14	1.50	4	26.04	78.12	M12.50
M14	1.25	4	26.04	78.12	M12.80

SIZE mm	PITCH mm	NO. OF FLUTES	PRICE		TAP DRILL SIZES mm
			TAPER, PLUG or BOTTOM	TAPER, PLUG & BOTTOM (3 PC SET)	
			SHTM	SHTMS	
M16	2.00	4	31.52	94.56	M14.00
M16	1.50	4	31.52	94.56	M14.50
M18	2.50	4	34.86	104.58	M15.50
M18	2.00	4	38.30	114.90	M16.00
M18	1.00	4	38.30	114.90	M17.00
M18	1.50	4	38.30	114.90	M16.50
M20	2.50	4	39.46	118.38	M17.50
M20	1.50	4	43.34	130.02	M18.50
M20	1.00	4	43.34	130.02	M19.00
M20	2.00	4	43.34	130.02	M18.00
M22	2.50	4	54.98	164.94	M19.50
M22	1.50	4	60.42	181.26	M20.50
M24	3.00	4	73.50	220.50	M21.00
M24	2.00	4	80.82	242.46	M22.00
M24	1.50	4	80.82	242.46	M22.50
M27	3.00	4	97.50	292.50	M24.00
M27	2.00	4	107.20	321.60	M25.00
M30	3.50	4	146.38	439.14	M26.50
M30	2.00	4	146.38	439.14	M28.00
M30	1.50	4	146.38	439.14	M28.50
M32	2.00	4	146.38	439.14	M30.00
M33	3.50	4	158.60	475.80	M29.50
M33	2.00	4	174.44	523.32	M31.00
M36	4.00	4	191.06	573.18	M32.00
M36	3.00	4	276.50	829.50	M33.00
M39	4.00	6	220.46	661.38	M35.00
M39	3.00	6	242.44	727.32	M36.00
M42	4.50	6	261.24	783.72	M37.50
M42	1.50	6	261.24	783.72	M40.50
M45	4.50	6	295.16	885.48	M40.50
M45	1.50	6	295.16	885.48	M43.50
M48	5.00	6	299.34	898.02	M43.00
M48	1.50	6	329.24	987.72	M46.50
M52	5.00	6	386.64	1159.92	M47.00
M52	1.50	6	391.36	1174.08	M50.50

Metric pitches in **bold type** are **coarse thread** form.

- Please specify Taper (T), Plug (P) or Bottoming (B) chamfer. Examples: SHTM04X.70T, SHTM10X1.50P, SHTM24X1.50B.

PACKAGING

M1.5 -M14 -12 Taps/Box • M16 - M24 - 3 Taps/Box • M27 - M52 - 1 Tap/Tub

NOTE: Titanium Nitride Coated Metric Hand Taps are available upon request.
Tap pitch diameter limits are those recommended for Class 6H tolerances.

HIGH SPEED STEEL METRIC (SPECIAL THREAD) HAND TAPS

ICS **WIS**

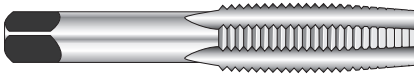

TAPER TAP (T)
7-10 Thread Chamfer
at 5 degrees per side

GENERAL PURPOSE

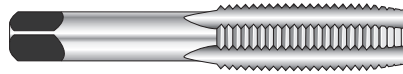

PLUG TAP (P)
3-5 Thread Chamfer
at 8 degrees per side

GROUND THREAD

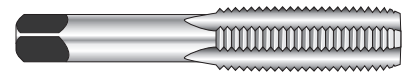

BOTTOMING TAP (B)
1-2 Thread Chamfer
at 18 degrees per side

Metric Special Thread Hand Taps are designed for applications where standard coarse, fine, or extra-fine thread taps are not applicable or where design considerations require non-standard pitches. Most sizes are available in taper, bottoming or plug chamfer. When taper or bottoming chamfer taps are not available in size ordered, plug chamfer taps will be substituted to complete order.

Sizes 1.4mm to 19mm

SIZE	PITCH	CHAMFER	ITEM NO.	PRICE
1.4	0.3	BOTTOM	STTM01.4X0.30B	16.00
1.4	0.3	PLUG	STTM01.4X0.30P	16.00
1.4	0.3	TAPER	STTM01.4X0.30T	16.00
1.7	0.2	BOTTOM	STTM01.7X0.20B	16.00
1.7	0.2	PLUG	STTM01.7X0.20P	16.00
1.7	0.2	TAPER	STTM01.7X0.20T	16.00
1.7	0.35	BOTTOM	STTM01.7X0.35B	16.00
1.7	0.35	PLUG	STTM01.7X0.35P	16.00
1.7	0.35	TAPER	STTM01.7X0.35T	16.00
2	0.25	BOTTOM	STTM02.0X0.25B	12.82
2	0.25	PLUG	STTM02.0X0.25P	12.82
2	0.25	TAPER	STTM02.0X0.25T	12.82
2	0.45	BOTTOM	STTM02.0X0.45B	12.82
2	0.45	PLUG	STTM02.0X0.45P	12.82
2	0.45	TAPER	STTM02.0X0.45T	12.82
2.2	0.4	BOTTOM	STTM02.2X0.40B	10.36
2.2	0.4	PLUG	STTM02.2X0.40P	10.36
2.2	0.4	TAPER	STTM02.2X0.40T	10.36
2.5	0.5	BOTTOM	STTM02.5X0.50B	10.36
2.5	0.5	PLUG	STTM02.5X0.50P	10.36
2.5	0.5	TAPER	STTM02.5X0.50T	10.36
2.6	0.35	BOTTOM	STTM02.6X0.35B	10.36
2.6	0.35	PLUG	STTM02.6X0.35P	10.36
2.6	0.35	TAPER	STTM02.6X0.35T	10.36
2.6	0.45	BOTTOM	STTM02.6X0.45B	CALL
2.6	0.45	PLUG	STTM02.6X0.45P	FOR
2.6	0.45	TAPER	STTM02.6X0.45T	PRICE
3	0.35	BOTTOM	STTM03.0X0.35B	8.00
3	0.35	PLUG	STTM03.0X0.35P	8.00
3	0.35	TAPER	STTM03.0X0.35T	8.00
3	0.6	BOTTOM	STTM03.0X0.60B	8.00
3	0.6	PLUG	STTM03.0X0.60P	8.00
3	0.6	TAPER	STTM03.0X0.60T	8.00
3.5	0.5	BOTTOM	STTM03.5X0.50B	8.00
3.5	0.5	PLUG	STTM03.5X0.50P	8.00
3.5	0.5	TAPER	STTM03.5X0.50T	8.00
4	0.5	BOTTOM	STTM04.0X0.50B	6.82
4	0.5	PLUG	STTM04.0X0.50P	6.82
4	0.5	TAPER	STTM04.0X0.50T	6.82
4	0.75	BOTTOM	STTM04.0X0.75B	6.82
4	0.75	PLUG	STTM04.0X0.75P	6.82
4	0.75	TAPER	STTM04.0X0.75T	6.82
4.5	0.5	BOTTOM	STTM04.5X0.50B	6.82
4.5	0.5	PLUG	STTM04.5X0.50P	6.82
4.5	0.5	TAPER	STTM04.5X0.50T	6.82
5	0.5	BOTTOM	STTM05.0X0.50B	6.82
5	0.5	PLUG	STTM05.0X0.50P	6.82
5	0.5	TAPER	STTM05.0X0.50T	6.82
5	0.7	BOTTOM	STTM05.0X0.70B	6.82
5	0.7	PLUG	STTM05.0X0.70P	6.82
5	0.7	TAPER	STTM05.0X0.70T	6.82
5	0.9	BOTTOM	STTM05.0X0.90B	6.82
5	0.9	PLUG	STTM05.0X0.90P	6.82
5	0.9	TAPER	STTM05.0X0.90T	6.82
5.5	0.7	BOTTOM	STTM05.5X0.70B	6.82
5.5	0.7	PLUG	STTM05.5X0.70P	6.82
5.5	0.7	TAPER	STTM05.5X0.70T	6.82
5.5	0.9	BOTTOM	STTM05.5X0.90B	6.82
5.5	0.9	PLUG	STTM05.5X0.90P	6.82
5.5	0.9	TAPER	STTM05.5X0.90T	6.82
6	0.5	BOTTOM	STTM06.0X0.50B	6.82
6	0.5	PLUG	STTM06.0X0.50P	6.82
6	0.5	TAPER	STTM06.0X0.50T	6.82
6	0.75	BOTTOM	STTM06.0X0.75B	6.96
6	0.75	PLUG	STTM06.0X0.75P	6.96
6	0.75	TAPER	STTM06.0X0.75T	6.96
7	0.5	BOTTOM	STTM07.0X0.50B	7.40
7	0.5	PLUG	STTM07.0X0.50P	7.40
7	0.5	TAPER	STTM07.0X0.50T	7.40
7	0.75	BOTTOM	STTM07.0X0.75B	7.40
7	0.75	PLUG	STTM07.0X0.75P	7.40
7	0.75	TAPER	STTM07.0X0.75T	7.40
7	1.25	BOTTOM	STTM07.0X1.25B	7.40
7	1.25	PLUG	STTM07.0X1.25P	7.40
7	1.25	TAPER	STTM07.0X1.25T	7.40

SIZE	PITCH	CHAMFER	ITEM NO.	PRICE
8	0.5	BOTTOM	STTM08.0X0.50B	8.20
8	0.5	PLUG	STTM08.0X0.50P	8.20
8	0.5	TAPER	STTM08.0X0.50T	8.20
8	0.75	BOTTOM	STTM08.0X0.75B	8.20
8	0.75	PLUG	STTM08.0X0.75P	8.20
8	0.75	TAPER	STTM08.0X0.75T	8.20
8	1.5	BOTTOM	STTM08.0X1.50B	8.20
8	1.5	PLUG	STTM08.0X1.50P	8.20
8	1.5	TAPER	STTM08.0X1.50T	8.20
9	0.5	BOTTOM	STTM09.0X0.50B	9.56
9	0.5	PLUG	STTM09.0X0.50P	9.56
9	0.5	TAPER	STTM09.0X0.50T	9.56
9	0.75	BOTTOM	STTM09.0X0.75B	9.56
9	0.75	PLUG	STTM09.0X0.75P	9.56
9	0.75	TAPER	STTM09.0X0.75T	9.56
9	1	BOTTOM	STTM09.0X1.00B	9.56
9	1	PLUG	STTM09.0X1.00P	9.56
9	1	TAPER	STTM09.0X1.00T	9.56
9	1.25	BOTTOM	STTM09.0X1.25B	9.56
9	1.25	PLUG	STTM09.0X1.25P	9.56
9	1.25	TAPER	STTM09.0X1.25T	9.56
10	0.5	BOTTOM	STTM10.0X0.50B	10.54
10	0.5	PLUG	STTM10.0X0.50P	10.54
10	0.5	TAPER	STTM10.0X0.50T	10.54
10	0.75	BOTTOM	STTM10.0X0.75B	10.54
10	0.75	PLUG	STTM10.0X0.75P	10.54
10	0.75	TAPER	STTM10.0X0.75T	10.54
10	1	BOTTOM	STTM10.0X1.00B	10.54
10	1	PLUG	STTM10.0X1.00P	10.54
10	1	TAPER	STTM10.0X1.00T	10.54
11	0.5	BOTTOM	STTM11.0X0.50B	12.70
11	0.5	PLUG	STTM11.0X0.50P	12.70
11	0.5	TAPER	STTM11.0X0.50T	12.70
11	0.75	BOTTOM	STTM11.0X0.75B	12.70
11	0.75	PLUG	STTM11.0X0.75P	12.70
11	0.75	TAPER	STTM11.0X0.75T	12.70
11	1	BOTTOM	STTM11.0X1.00B	12.70
11	1	PLUG	STTM11.0X1.00P	12.70
11	1	TAPER	STTM11.0X1.00T	12.70
11	1.25	BOTTOM	STTM11.0X1.25B	12.70
11	1.25	PLUG	STTM11.0X1.25P	12.70
11	1.25	TAPER	STTM11.0X1.25T	12.70
12	0.5	BOTTOM	STTM12.0X0.50B	18.74
12	0.5	PLUG	STTM12.0X0.50P	18.74
12	0.5	TAPER	STTM12.0X0.50T	18.74
12	0.75	BOTTOM	STTM12.0X0.75B	18.74
12	0.75	PLUG	STTM12.0X0.75P	18.74
12	0.75	TAPER	STTM12.0X0.75T	18.74
12	1	BOTTOM	STTM12.0X1.00B	18.74
12	1	PLUG	STTM12.0X1.00P	18.74
12	1	TAPER	STTM12.0X1.00T	18.74
12	1.5	BOTTOM	STTM12.0X1.50B	18.74
12	1.5	PLUG	STTM12.0X1.50P	18.74
12	1.5	TAPER	STTM12.0X1.50T	18.74
13	0.5	BOTTOM	STTM13.0X0.50B	26.44
13	0.5	PLUG	STTM13.0X0.50P	26.44
13	0.5	TAPER	STTM13.0X0.50T	26.44
13	1	BOTTOM	STTM13.0X1.00B	26.44
13	1	PLUG	STTM13.0X1.00P	26.44
13	1	TAPER	STTM13.0X1.00T	26.44
13	1.25	BOTTOM	STTM13.0X1.25B	26.44
13	1.25	PLUG	STTM13.0X1.25P	26.44
13	1.25	TAPER	STTM13.0X1.25T	26.44
13	1.5	BOTTOM	STTM13.0X1.50B	26.44
13	1.5	PLUG	STTM13.0X1.50P	26.44
13	1.5	TAPER	STTM13.0X1.50T	26.44
13	1.75	PLUG	STTM13.0X1.75P	26.44
13	2	BOTTOM	STTM13.0X2.00B	26.44
13	2	PLUG	STTM13.0X2.00P	26.44
13	2	TAPER	STTM13.0X2.00T	26.44
14	0.5	BOTTOM	STTM14.0X0.50B	28.00
14	0.5	PLUG	STTM14.0X0.50P	28.00
14	0.5	TAPER	STTM14.0X0.50T	28.00
14	0.75	BOTTOM	STTM14.0X0.75B	28.00
14	0.75	PLUG	STTM14.0X0.75P	28.00

SIZE	PITCH	CHAMFER	ITEM NO.	PRICE
14	0.75	TAPER	STTM14.0X0.75T	28.00
14	1	BOTTOM	STTM14.0X1.00B	28.00
14	1	PLUG	STTM14.0X1.00P	28.00
14	1	TAPER	STTM14.0X1.00T	28.00
14	1.25	BOTTOM	STTM14.0X1.25B	28.00
14	1.25	PLUG	STTM14.0X1.25P	28.00
14	1.25	TAPER	STTM14.0X1.25T	28.00
14	1.75	BOTTOM	STTM14.0X1.75B	28.00
14	1.75	PLUG	STTM14.0X1.75P	28.00
14	1.75	TAPER	STTM14.0X1.75T	28.00
15	0.5	BOTTOM	STTM15.0X0.50B	28.00
15	0.5	PLUG	STTM15.0X0.50P	28.00
15	0.5	TAPER	STTM15.0X0.50T	28.00
15	1	BOTTOM	STTM15.0X1.00B	28.00
15	1	PLUG	STTM15.0X1.00P	28.00
15	1	TAPER	STTM15.0X1.00T	28.00
15	1.5	BOTTOM	STTM15.0X1.50B	28.00
15	1.5	PLUG	STTM15.0X1.50P	28.00
15	1.5	TAPER	STTM15.0X1.50T	28.00
15	2	BOTTOM	STTM15.0X2.00B	28.00
15	2	PLUG	STTM15.0X2.00P	28.00
15	2	TAPER	STTM15.0X2.00T	28.00
16	0.5	BOTTOM	STTM16.0X0.50B	32.58
16	0.5	PLUG	STTM16.0X0.50P	32.58
16	0.5	TAPER	STTM16.0X0.50T	32.58
16	0.75	BOTTOM	STTM16.0X0.75B	32.58
16	0.75	PLUG	STTM16.0X0.75P	32.58
16	0.75	TAPER	STTM16.0X0.75T	32.58
16	1	BOTTOM	STTM16.0X1.00B	32.58
16	1	PLUG	STTM16.0X1.00P	32.58
16	1	TAPER	STTM16.0X1.00T	32.58
16	1.25	BOTTOM	STTM16.0X1.25B	32.58
16	1.25	PLUG	STTM16.0X1.25P	32.58
16	1.25	TAPER	STTM16.0X1.25T	32.58
16	1.75	BOTTOM	STTM16.0X1.75B	32.58
16	1.75	PLUG	STTM16.0X1.75P	32.58
16	1.75	TAPER	STTM16.0X1.75T	32.58
16	2.5	BOTTOM	STTM16.0X2.50B	CALL
16	2.5	PLUG	STTM16.0X2.50P	FOR
16	2.5	TAPER	STTM16.0X2.50T	PRICE
17	0.5	BOTTOM	STTM17.0X0.50B	33.80
17	0.5	PLUG	STTM17.0X0.50P	33.80
17	0.5	TAPER	STTM17.0X0.50T	33.80
17	1	BOTTOM	STTM17.0X1.00B	33.80
17	1	PLUG	STTM17.0X1.00P	33.80
17	1	TAPER	STTM17.0X1.00T	33.80
17	1.5	BOTTOM	STTM17.0X1.50B	33.80
17	1.5	PLUG	STTM17.0X1.50P	33.80
17	1.5	TAPER	STTM17.0X1.50T	33.80
17	2	BOTTOM	STTM17.0X2.00B	33.80
17	2	PLUG	STTM17.0X2.00P	33.80
17	2	TAPER	STTM17.0X2.00T	33.80
18	0.5	BOTTOM	STTM18.0X0.50B	38.68
18	0.5	PLUG	STTM18.0X0.50P	38.68
18	0.5	TAPER	STTM18.0X0.50T	38.68
18	1	BOTTOM	STTM18.0X1.00B	38.68
18	1	PLUG	STTM18.0X1.00P	38.68
18	1	TAPER	STTM18.0X1.00T	38.68
18	1.25	BOTTOM	STTM18.0X1.25B	38.68
18	1.25	PLUG	STTM18.0X1.25P	38.68
18	1.25	TAPER	STTM18.0X1.25T	38.68
18	1.75	BOTTOM	STTM18.0X1.75B	38.68
18	1.75	PLUG	STTM18.0X1.75P	38.68
18	1.75	TAPER	STTM18.0X1.75T	38.68
18	2	BOTTOM	STTM18.0X2.00B	38.68

HIGH SPEED STEEL METRIC (SPECIAL THREAD) HAND TAPS

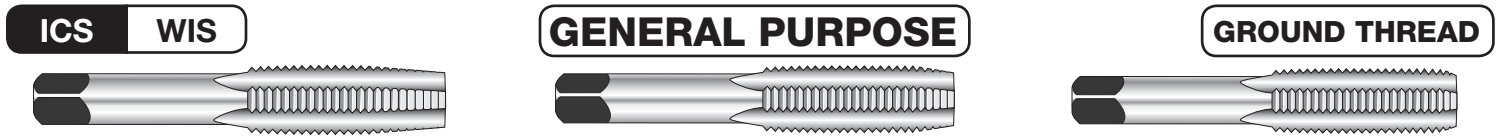

TAPER TAP (T)
7-10 Thread Chamfer
at 5 degrees per side

PLUG TAP (P)
3-5 Thread Chamfer
at 8 degrees per side

BOTTOMING TAP (B)
1-2 Thread Chamfer
at 18 degrees per side

Sizes 19mm to 52mm

SIZE	PITCH	CHAMFER	ITEM NO.	PRICE	SIZE	PITCH	CHAMFER	ITEM NO.	PRICE	SIZE	PITCH	CHAMFER	ITEM NO.	PRICE
19	1.5	TAPER	STTM19.0X1.50T	40.48	25	2	TAPER	STTM25.0X2.0T	89.82	36	1.5	BOTTOM	STTM36.0X1.50B	172.56
19	2	BOTTOM	STTM19.0X2.0B	40.48	25	3	BOTTOM	STTM25.0X3.0B	89.82	36	1.5	PLUG	STTM36.0X1.50P	172.56
19	2	PLUG	STTM19.0X2.0P	40.48	25	3	PLUG	STTM25.0X3.0P	89.82	36	1.5	TAPER	STTM36.0X1.50T	172.56
19	2	TAPER	STTM19.0X2.0T	40.48	25	3	TAPER	STTM25.0X3.0T	89.82	38	1.5	BOTTOM	STTM38.0X1.50B	220.02
20	1	BOTTOM	STTM20.0X1.00B	44.80	26	1.5	BOTTOM	STTM26.0X1.5B	88.04	38	1.5	PLUG	STTM38.0X1.50P	220.02
20	1	PLUG	STTM20.0X1.00P	44.80	26	1.5	PLUG	STTM26.0X1.5P	88.04	38	1.5	TAPER	STTM38.0X1.50T	220.02
20	1	TAPER	STTM20.0X1.00T	44.80	26	1.5	TAPER	STTM26.0X1.5T	88.04	39	1.5	BOTTOM	STTM39.0X1.50B	228.02
20	1.25	BOTTOM	STTM20.0X1.25B	44.80	26	2	BOTTOM	STTM26.0X2.0B	88.04	39	1.5	PLUG	STTM39.0X1.50P	228.02
20	1.25	PLUG	STTM20.0X1.25P	44.80	26	2	PLUG	STTM26.0X2.0P	88.04	39	1.5	TAPER	STTM39.0X1.50T	228.02
20	1.25	TAPER	STTM20.0X1.25T	44.80	26	2	TAPER	STTM26.0X2.0T	88.04	40	1.5	BOTTOM	STTM40.0X1.50B	247.16
20	2	BOTTOM	STTM20.0X2.00B	44.80	27	1	BOTTOM	STTM27.0X1.0B	110.88	40	1.5	PLUG	STTM40.0X1.50P	247.16
20	2	PLUG	STTM20.0X2.00P	44.80	27	1	PLUG	STTM27.0X1.0P	110.88	40	1.5	TAPER	STTM40.0X1.50T	247.16
20	2	TAPER	STTM20.0X2.00T	44.80	27	1	TAPER	STTM27.0X1.0T	110.88	42	1.5	BOTTOM	STTM42.0X1.50B	247.16
21	1	BOTTOM	STTM21.0X1.0B	47.14	27	1.5	BOTTOM	STTM27.0X1.5B	110.88	42	1.5	PLUG	STTM42.0X1.50P	247.16
21	1	PLUG	STTM21.0X1.0P	47.14	27	1.5	PLUG	STTM27.0X1.5P	110.88	42	1.5	TAPER	STTM42.0X1.50T	247.16
21	1	TAPER	STTM21.0X1.0T	47.14	27	1.5	TAPER	STTM27.0X1.5T	110.88	42	3	BOTTOM	STTM42.0X3.0B	247.16
21	1.5	BOTTOM	STTM21.0X1.50B	47.14	27	2.5	BOTTOM	STTM27.0X2.5B	110.88	42	3	PLUG	STTM42.0X3.0P	247.16
21	1.5	PLUG	STTM21.0X1.50P	47.14	27	2.5	PLUG	STTM27.0X2.5P	110.88	42	3	TAPER	STTM42.0X3.0T	247.16
21	1.5	TAPER	STTM21.0X1.50T	47.14	27	2.5	TAPER	STTM27.0X2.5T	110.88	42	4.5	BOTTOM	STTM42.0X4.50B	247.16
21	2	BOTTOM	STTM21.0X2.0B	47.14	27	2.5	TAPER	STTM27.0X2.5T	110.88	42	4.5	PLUG	STTM42.0X4.50P	247.16
21	2	PLUG	STTM21.0X2.0P	47.14	28	1.5	BOTTOM	STTM28.0X1.5B	127.16	42	4.5	TAPER	STTM42.0X4.50T	247.16
21	2	TAPER	STTM21.0X2.0T	47.14	28	1.5	PLUG	STTM28.0X1.5P	127.16	45	1.5	BOTTOM	STTM45.0X1.50B	266.88
21	2.5	BOTTOM	STTM21.0X2.5B	47.14	28	1.5	TAPER	STTM28.0X1.5T	127.16	45	1.5	PLUG	STTM45.0X1.50P	266.88
21	2.5	PLUG	STTM21.0X2.5P	47.14	28	2	BOTTOM	STTM28.0X2.0B	127.16	45	1.5	TAPER	STTM45.0X1.50T	266.88
21	2.5	TAPER	STTM21.0X2.5T	47.14	28	2	PLUG	STTM28.0X2.0P	127.16	45	3	BOTTOM	STTM45.0X3.0B	266.88
22	1	BOTTOM	STTM22.0X1.0B	61.34	28	2	TAPER	STTM28.0X2.0T	127.16	45	3	PLUG	STTM45.0X3.0P	266.88
22	1	PLUG	STTM22.0X1.0P	61.34	30	1	BOTTOM	STTM30.0X1.0B	150.68	45	3	TAPER	STTM45.0X3.0T	266.88
22	1	TAPER	STTM22.0X1.0T	61.34	30	1	PLUG	STTM30.0X1.0P	150.68	45	3	BOTTOM	STTM45.0X4.50B	266.88
22	2	BOTTOM	STTM22.0X2.0B	61.34	30	1	TAPER	STTM30.0X1.0T	150.68	45	4.5	PLUG	STTM45.0X4.50P	266.88
22	2	PLUG	STTM22.0X2.0P	61.34	30	2.5	BOTTOM	STTM30.0X2.50B	150.68	45	4.5	TAPER	STTM45.0X4.50T	266.88
22	2	TAPER	STTM22.0X2.0T	61.34	30	2.5	PLUG	STTM30.0X2.50P	150.68	48	1.5	BOTTOM	STTM48.0X1.50B	288.94
23	1	BOTTOM	STTM23.0X1.00B	62.66	30	2.5	TAPER	STTM30.0X2.50T	150.68	48	1.5	PLUG	STTM48.0X1.50P	288.94
23	1	PLUG	STTM23.0X1.00P	62.66	30	3	BOTTOM	STTM30.0X3.0B	150.68	48	1.5	TAPER	STTM48.0X1.50T	288.94
23	1	TAPER	STTM23.0X1.00T	62.66	30	3	PLUG	STTM30.0X3.0P	150.68	48	3	BOTTOM	STTM48.0X3.0B	288.94
23	1.5	BOTTOM	STTM23.0X1.50B	62.66	30	3	TAPER	STTM30.0X3.0T	150.68	48	3	PLUG	STTM48.0X3.0P	288.94
23	1.5	PLUG	STTM23.0X1.50P	62.66	32	1.5	BOTTOM	STTM32.0X1.50B	162.02	48	3	TAPER	STTM48.0X3.0T	288.94
23	1.5	TAPER	STTM23.0X1.50T	62.66	32	1.5	PLUG	STTM32.0X1.50P	162.02	48	4.5	BOTTOM	STTM48.0X4.50B	288.94
23	2	BOTTOM	STTM23.0X2.0B	62.66	32	1.5	TAPER	STTM32.0X1.50T	162.02	48	4.5	PLUG	STTM48.0X4.50P	288.94
23	2	PLUG	STTM23.0X2.0P	62.66	32	2	BOTTOM	STTM32.0X2.00B	162.02	48	4.5	TAPER	STTM48.0X4.50T	288.94
23	2	TAPER	STTM23.0X2.0T	62.66	32	2	PLUG	STTM32.0X2.00P	162.02	48	5	BOTTOM	STTM48.0X5.00B	288.94
23	2.5	BOTTOM	STTM23.0X2.50B	62.66	32	2	TAPER	STTM32.0X2.00T	162.02	48	5	PLUG	STTM48.0X5.00P	288.94
23	2.5	PLUG	STTM23.0X2.50P	62.66	33	1.5	BOTTOM	STTM33.0X1.50B	145.60	48	5	TAPER	STTM48.0X5.00T	288.94
23	2.5	TAPER	STTM23.0X2.50T	62.66	33	1.5	PLUG	STTM33.0X1.50P	145.60	50	1.5	BOTTOM	STTM50.0X1.50B	355.54
23	3	BOTTOM	STTM23.0X3.0B	62.66	33	1.5	TAPER	STTM33.0X1.50T	145.60	50	1.5	PLUG	STTM50.0X1.50P	355.54
23	3	PLUG	STTM23.0X3.0P	62.66	33	2	BOTTOM	STTM33.0X2.00B	145.60	50	1.5	TAPER	STTM50.0X1.50T	355.54
23	3	TAPER	STTM23.0X3.0T	62.66	33	2	PLUG	STTM33.0X2.00P	145.60	50	3	BOTTOM	STTM50.0X3.0B	355.54
24	1	BOTTOM	STTM24.0X1.00B	69.64	33	2	TAPER	STTM33.0X2.00T	145.60	50	3	PLUG	STTM50.0X3.0P	355.54
24	1	PLUG	STTM24.0X1.00P	69.64	33	3	BOTTOM	STTM33.0X3.0B	CALL	50	3	TAPER	STTM50.0X3.0T	355.54
24	1	TAPER	STTM24.0X1.00T	69.64	33	3	PLUG	STTM33.0X3.0P	FOR	52	1.5	BOTTOM	STTM52.0X1.50B	355.54
25	1	BOTTOM	STTM25.0X1.00B	89.82	33	3	TAPER	STTM33.0X3.0T	PRICE	52	1.5	PLUG	STTM52.0X1.50P	355.54
25	1	PLUG	STTM25.0X1.00P	89.82	33	3.5	BOTTOM	STTM33.0X3.5B		52	1.5	TAPER	STTM52.0X1.50T	355.54
25	1	TAPER	STTM25.0X1.00T	89.82	33	3.5	PLUG	STTM33.0X3.5P		52	3	BOTTOM	STTM52.0X3.0B	355.54
25	1.5	BOTTOM	STTM25.0X1.50B	89.82	33	3.5	TAPER	STTM33.0X3.5T		52	3	PLUG	STTM52.0X3.0P	355.54
25	1.5	PLUG	STTM25.0X1.50P	89.82	34	1.5	BOTTOM	STTM34.0X1.50B	193.36	52	3	TAPER	STTM52.0X3.0T	355.54
25	1.5	TAPER	STTM25.0X1.50T	89.82	34	1.5	PLUG	STTM34.0X1.50P	193.36	52	5	BOTTOM	STTM52.0X5.00B	355.54
25	2	BOTTOM	STTM25.0X2.00B	89.82	34	1.5	TAPER	STTM34.0X1.50T	193.36	52	5	PLUG	STTM52.0X5.00P	355.54
25	2	PLUG	STTM25.0X2.00P	89.82	35	1.5	BOTTOM	STTM35.0X1.50B	204.70	52	5	TAPER	STTM52.0X5.00T	355.54
					35	1.5	PLUG	STTM35.0X1.50P	204.70					
					35	1.5	TAPER	STTM35.0X1.50T	204.70					

HIGH SPEED STEEL LEFT HAND THREAD METRIC TAPS



Metric Left Hand Taps are designed to cut threads with a left hand rotation and are commonly used in applications where left hand studs and fasteners are needed.

SIZE	PITCH	ITEM NO.	SIZE	PITCH	ITEM NO.	SIZE	PITCH	ITEM NO.	SIZE	PITCH	ITEM NO.
M2.0	.40	HTML02.0X0.40	M7.0	1.00	HTML07.0X1.00	M12	1.75	HTML12.0X1.75	M18	1.50	HTML18.0X1.50
M3.0	.50	HTML03.0X0.50	M8.0	1.25	HTML08.0X1.25	M14	1.50	HTML14.0X1.50	M18	2.00	HTML18.0X2.00
M4.0	.70	HTML04.0X0.70	M10	1.25	HTML10.0X1.25	M14	2.00	HTML14.0X2.00	M18	2.50	HTML18.0X2.50
M5.0	.80	HTML05.0X0.80	M10	1.50	HTML10.0X1.50	M16	1.50	HTML16.0X1.50	M20	1.50	HTML20.0X1.50
M6.0	1.00	HTML06.0X1.00	M12	1.25	HTML12.0X1.25	M16	2.00	HTML16.0X2.00	M20	2.50	HTML20.0X2.50

Metric pitches in **bold type** are **coarse thread** form. CALL FOR PRICING

HIGH SPEED STEEL BRITISH STANDARD HAND TAPS

ICS USA

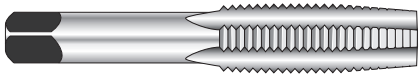

(B.S.W.)

The British Standard Whitworth Thread form is a coarse thread and its use is similar to the UNC or NC thread series. The sides of the thread form an angle of 55° with one another.

GENERAL PURPOSE

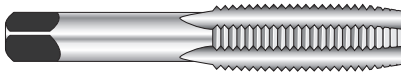

(B.S.F.)

The British Standard Fine Thread form is a fine thread and its use is similar to the UNF or NF thread series. The sides of the thread form an angle of 55° with one another.

RIGHT HAND CUTTING

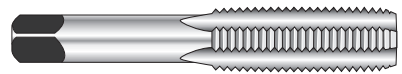

(B.A.)

The British Association Thread form is an extra fine thread and its use is similar to the NEF thread series. The sides of the thread form an angle of 47.5° with one another.

ITEM NO. BSTW

ITEM NO. BSTF

ITEM NO. BSTA

All British Standard Hand Taps are available with a Taper, Plug, or Bottom chamfer

Tap pricing quoted upon request

SIZE	THREADS PER INCH			NO. OF FLUTES	TAP DRILL SIZES APPROX. 75-80% THREAD (mm)		
	(B.S.W.)	(B.S.F.)	(B.A.)		(B.S.W.)	(B.S.F.)	(B.A.)
0	-	-	25.4	3	-	-	M05.10
1	-	-	28.2	3	-	-	M04.50
2	-	-	31.4	3	-	-	M04.00
3	-	-	34.8	3	-	-	M03.40
4	-	-	38.5	3	-	-	M03.00
5	-	-	43.0	3	-	-	M02.65
6	-	-	47.9	3	-	-	M02.30
7	-	-	52.9	3	-	-	M02.05
8	-	-	59.1	3	-	-	M01.80
9	-	-	65.1	3	-	-	M01.55
10	-	-	72.6	3	-	-	M01.40
12	-	-	90.7	3	-	-	M01.05
1/8	40	-	-	3	M02.55	-	-
3/16	24	32	-	3	M03.70	M04.00	-
1/4	20	26	-	3	M05.10	M05.30	-
5/16	18	22	-	4	M06.50	M06.80	-
3/8	16	20	-	4	M07.90	M08.30	-
7/16	14	18	-	4	M09.30	M09.70	-
1/2	12	16	-	4	M10.50	M11.10	-
9/16	12	16	-	4	M12.10	M12.70	-
5/8	11	14	-	4	M13.50	M14.00	-
3/4	10	12	-	4	M16.25	M16.75	-
7/8	9	11	-	4	M19.25	M19.75	-
1	8	10	-	4	M22.00	M22.75	-
1-1/8	7	9	-	4	M24.75	M25.50	-
1-1/4	7	9	-	4	M28.00	M28.50	-
1-3/8	6	8	-	4	M30.50	M31.50	-
1-1/2	6	8	-	4	M33.50	M34.50	-
2	4-1/2	7	-	6	M44.50	M47.00	-

British Thread Spiral Point and Spiral Flute Taps can also be supplied to order.

PACKAGING

- #0 to 12 - 12 Taps/Box
- 1/8 to 1/2 - 12 Taps/Box
- 9/16 to 1 - 3 Taps/Box
- 1-1/8 to 2 - 1 Tap/Tube

Tap pitch diameter limits are in accordance with BS 949 Part 2 - 1979

CARBON STEEL STANDARD HAND TAPS

ICS USA

GENERAL PURPOSE

CUT THREAD

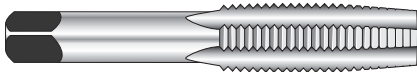

TAPER TAP
7-10 Thread Chamfer
at 5 degrees per side

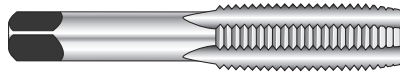

PLUG TAP
3-5 Thread Chamfer
at 8 degrees per side

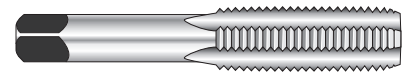

BOTTOMING TAP
1-2 Thread Chamfer
at 18 degrees per side

Carbon Steel Hand Taps with straight flutes are designed for general purpose hand tapping operations where ground thread accuracy and performance is not required. They can also be used for rethreading damaged threads. Carbon steel hand taps are the most cost effective threading tap available.

SIZE	THREADS PER INCH			NO. OF FLUTES	TAPER, PLUG, or BOTTOM		PKG. QTY.	TAPER, PLUG, & BOTTOM 3 pc set	
	NC - UNC	NF - UNF	NS		CHT			CHTS	
#0	-	80	-	3	3.50		12	10.50	
#1	64	72	-	3	3.50		12	10.50	
#2	56	64	-	3	3.50		12	10.50	
#3	48	-	-	3	3.26		12	9.78	
#4	40	48	-	3	2.62		12	7.86	
#5 - 1/8	40	44	-	3	2.40		12	7.20	
#6	32	40	-	3	2.40		12	7.20	
#8 - 5/32	32	36	-	4	2.40		12	7.20	
#10 - 3/16	24	32	-	4	2.40		12	7.20	
#12 - 7/32	24	28	-	4	2.50		12	7.50	
1/4	20	28	-	4	2.44		12	7.32	
5/16	18	24	-	4	3.36		12	10.08	
3/8	16	24	-	4	3.72		12	11.16	
7/16	14	20	-	4	4.28		12	12.84	
1/2	13	20	-	4	4.78		12	14.34	
9/16	12	18	-	4	6.86		3	20.58	
5/8	11	18	-	4	8.42		3	25.26	
3/4	10	16	-	4	11.32		3	33.96	
7/8	9	14	-	4	16.26		3	48.78	
1	8	12	14	4	19.84		3	59.52	
1-1/8	7	12	-	4	24.96		1	74.88	
1-1/4	7	12	-	4-6	33.18		1	99.54	
1-3/8	6	12	-	4-6	41.64		1	124.92	
1-1/2	6	12	-	4-6	49.94		1	149.82	

CARBON STEEL METRIC HAND TAPS

ICS USA

GENERAL PURPOSE

CUT THREAD

SIZE	PITCH	ITEM NO.	PRICE
M3	0.50	CHTM03X.50()	2.90
*M3	0.60	CHTM03X.60P	2.90
*M3.5	0.60	CHTM03.5X.60P	2.90
M4	0.70	CHTM04X.70()	2.40
*M4	0.75	CHTM04X.75P	2.40
M5	0.80	CHTM05X.80()	2.44
*M5	0.90	CHTM05X.90P	2.44
*M5.5	0.90	CHTM05.5X.90P	2.44
M6	1.00	CHTM06X1.0()	2.72
*M6.3	1.00	CHTM06.3X1.0P	2.72
M7	1.00	CHTM07X1.0()	3.02
M8	1.00	CHTM08X1.0()	3.36
M8	1.25	CHTM08X1.25()	3.36

SIZE	PITCH	ITEM NO.	PRICE
*M9	0.75	CHTM09X0.75P	4.04
*M9	1.00	CHTM09X1.0P	4.04
M9	1.25	CHTM09X1.25()	4.04
M10	1.00	CHTM10X1.00()	4.66
M10	1.25	CHTM10X1.25()	4.66
M10	1.50	CHTM10X1.50()	4.66
*M11	1.50	CHTM11X1.50P	5.02
M12	1.25	CHTM12X1.25()	5.66
M12	1.50	CHTM12X1.50()	5.66
M12	1.75	CHTM12X1.75()	5.66
M14	1.25	CHTM14X1.25()	7.14
M14	1.50	CHTM14X1.50()	7.14
M14	2.00	CHTM14X2.00()	7.14

SIZE	PITCH	ITEM NO.	PRICE
*M16	1.00	CHTM16X1.00P	8.72
M16	1.50	CHTM16X1.50()	8.72
M16	2.00	CHTM16X2.00()	8.72
M18	1.50	CHTM18X1.50()	10.04
M18	2.50	CHTM18X2.50()	10.04
M20	1.50	CHTM20X1.50()	14.42
M20	2.50	CHTM20X2.50()	14.42
M22	1.50	CHTM22X1.50()	15.04
M22	2.50	CHTM22X2.50()	15.04
*M24	1.50	CHTM24X1.50P	18.42
M24	2.00	CHTM24X2.00()	18.42
M24	3.00	CHTM24X3.00()	18.42

Metric pitches in **bold type** are **coarse thread** form.

- Please specify Taper (T), Plug (P) or Bottoming (B) chamfer. Examples: CHTM04X.70T, CHTM10X1.50P, CHTM24X1.50B.
- * Plug only

HIGH SPEED STEEL COMBINED DRILL AND TAPS

TT-18

ICS USA

HEAVY DUTY

118° NOTCHED POINT

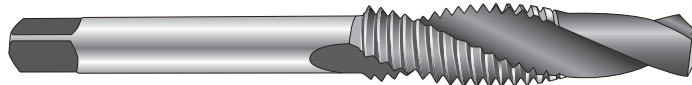

**RIGHT HAND
CUT**

High Speed Steel Fractional Combined Drill and Taps are designed to drill and tap a threaded hole up to two times the tap diameter in one operation. Drill should protrude through material before tapping. The tap section has ground threads and a bottoming chamfer for easier tapping. They are designed to operate at speeds between the normal tapping speed and drilling speed for the specific type of material it is used in.

Machine Screw and Fractional Sizes (#4 To 3/4" Dia.)

TAP SIZE	THREADS PER INCH	NO. OF FLUTES	THREAD LENGTH	OVERALL LENGTH	DRILL DIAMETER	DRILL LENGTH	ITEM NO.	PRICE
4	40	2	9/16	1-7/8	.0930	1/4	CDT#04-40	-
4	48	2	9/16	1-7/8	.0930	1/4	CDT#04-48	-
5	40	2	5/8	1-15/16	.1040	9/32	CDT#05-40	-
5	44	2	5/8	1-15/16	.1040	9/32	CDT#05-44	-
6	32	2	11/16	2	.1150	5/16	CDT#06-32	-
6	40	2	11/16	2	.1150	5/16	CDT#06-40	-
8	32	2	7/16	2-1/8	.1385	5/16	CDT#08-32	-
8	36	2	3/4	2-1/8	.1385	3/8	CDT#08-36	-
10	24	2	5/8	2-3/8	.1535	3/8	CDT#10-24	-
10	32	2	5/8	2-3/8	.1535	3/8	CDT#10-32	-
12	24	2	5/8	2-3/8	.1772	3/8	CDT#12-24	-
12	28	2	7/8	2-3/8	.1772	15/32	CDT#12-28	-
1/4	20	2	11/16	2-3/8	.2008	1/2	CDT016-20	CALL FOR PRICE
1/4	28	2	11/16	2-1/2	.2008	1/2	CDT016-28	CALL FOR PRICE
5/16	18	2	13/16	3	.2559	5/8	CDT020-18	CALL FOR PRICE
5/16	24	2	13/16	3	.2559	5/8	CDT020-24	CALL FOR PRICE
3/8	16	2	7/8	3-1/2	.3150	3/4	CDT024-16	CALL FOR PRICE
3/8	24	2	7/8	3-1/2	.3150	3/4	CDT024-24	CALL FOR PRICE
7/16	14	2	1	3-7/8	.3622	7/8	CDT028-14	CALL FOR PRICE
7/16	20	2	1	3-7/8	.3622	7/8	CDT028-20	CALL FOR PRICE
1/2	13	2	1-1/8	4-1/4	.4252	1	CDT032-13	CALL FOR PRICE
1/2	20	2	1-1/8	4-1/4	.4252	1	CDT032-20	CALL FOR PRICE
9/16	12	2	1-3/16	4-7/8	.4803	1-3/16	CDT036-12	CALL FOR PRICE
9/16	18	2	1-3/16	4-7/8	.4803	1-3/16	CDT036-18	CALL FOR PRICE
5/8	11	2	1-1/4	5-1/4	.5315	1-1/4	CDT040-11	CALL FOR PRICE
5/8	18	2	1-1/4	5-1/4	.5315	1-1/4	CDT040-18	CALL FOR PRICE
3/4	10	2	1-3/8	5-5/8	.6920	1-3/8	CDT048-10	CALL FOR PRICE
3/4	16	2	1-3/8	5-5/8	.6920	1-3/8	CDT048-16	CALL FOR PRICE

NOTE: Combined Drill and Taps are available in longer lengths. Inquire for sizes and pricing.

High Speed Steel Metric Combined Drill and Taps are designed to drill and tap a threaded hole up to two times the tap diameter in one operation. Drill should protrude through material before tapping. The tap section has ground threads and a bottoming chamfer for easier tapping. They are designed to operate at speeds between the normal tapping speed and drilling speed for the specific type of material it is used in.

Metric Sizes (4.0mm To 12.0mm Dia.)

TAP SIZE	THREADS PER INCH	NO. OF FLUTES	THREAD LENGTH	OVERALL LENGTH	DRILL DIAMETER	DRILL LENGTH	ITEM NO.	PRICE
M4	0.70	2	7/16	2-9/16	.1299	5/16	CDTM04.0X0.70	-
M5	0.80	2	5/8	2-3/4	.1654	3/8	CDTM05.0X0.80	CALL FOR PRICE
M6	1.00	2	11/16	3-3/8	.1969	1/2	CDTM06.0X1.00	CALL FOR PRICE
M8	1.25	2	13/16	3-3/4	.2677	5/8	CDTM08.0X1.25	CALL FOR PRICE
M10	1.50	2	7/8	4-3/16	.3346	3/4	CDTM10.0X1.50	CALL FOR PRICE
M12	1.75	2	1-1/8	4-1/2	.4016	1	CDTM12.0X1.75	CALL FOR PRICE

HIGH SPEED STEEL (STI) SCREW THREAD INSERT HAND TAPS

ICS USA

SPECIAL PURPOSE

GROUND THREAD

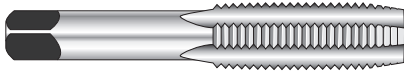

PLUG TAP
3-5 Thread Chamfer
at 8 degrees per side

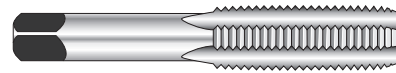

BOTTOMING TAP
1-2 Thread Chamfer
at 18 degrees per side

High Speed Steel STI (Screw Thread Insert) Hand Taps are oversize taps designed to produce threads that will accommodate a "Helicoil" or screw thread inserts of the same nominal size and pitch.

SIZE	NO. OF FLUTES	LIMIT NO.	NC UNC - COARSE THREAD			NF UNF - FINE THREAD			PRICE EACH
			TPI	ITEM NO.		TPI	ITEM NO.		
				PLUG	BOTTOMING		PLUG	BOTTOMING	
4	3	H2	40	STIT#04-40P	STIT#04-40B				21.46
6	3	H3	32	STIT#06-40P	STIT#06-40B				21.46
8	3	H3	32	STIT#08-32P	STIT#08-32B				23.42
10	3	H3	24	STIT#10-24P	STIT#10-24B	32	STIT#10-32P	STIT#10-32B	24.12
1/4	3	H3	20	STIT016-20P	STIT016-20B	28	STIT016-28P	STIT016-28B	23.46
5/16	4	H3	18	STIT020-18P	STIT020-18B	24	STIT020-24P	STIT020-24B	27.64
3/8	4	H3	16	STIT024-16P	STIT024-16B	24	STIT024-24P	STIT024-24B	35.88
7/16	4	H3	14	STIT028-14P	STIT028-14B	20	STIT028-20P	STIT028-20B	39.48
1/2	4	H3	13	STIT032-13P	STIT032-13B	20	STIT032-20P	STIT032-20B	46.12
3/4	4	H3	10	STIT048-10P	STIT048-10B				66.18

HIGH SPEED STEEL (STI) SCREW THREAD INSERT SPIRAL POINT PLUG TAPS

ICS USA

SPECIAL PURPOSE

GROUND THREAD

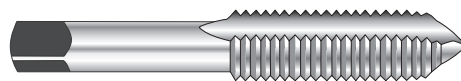

PLUG CHAMFER

High Speed Steel STI (Screw Thread Insert) Spiral Point Taps are oversize taps designed to produce threads that will accommodate a "Helicoil" or screw thread inserts of the same nominal size and pitch.

SIZE	NO. OF FLUTES	LIMIT NO.	NC UNC - COARSE THREAD		NF UNF - FINE THREAD		PRICE EACH
			TPI	ITEM NO.	TPI	ITEM NO.	
				PLUG		PLUG	
4	2	H2	40	STISPT#04-40			22.94
6	2	H3	32	STISPT#06-40			22.94
8	2	H3	32	STISPT#08-32			24.70
10	2	H3	24	STISPT#10-24	32	STISPT#10-32	25.62
1/4	2	H3	20	STISPT016-20	28	STISPT016-28	25.26
5/16	3	H3	18	STISPT020-18	24	STISPT020-24	29.24
3/8	3	H3	16	STISPT024-16	24	STISPT024-24	38.48
7/16	3	H3	14	STISPT028-14	20	STISPT028-20	45.86
1/2	3	H3	13	STISPT032-13	20	STISPT032-20	49.98

HIGH SPEED STEEL SPIRAL POINT TAPS (GUN TAPS)

ICS **WIS**

GENERAL PURPOSE

GROUND THREAD

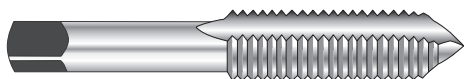

HSS UNCOATED (Bright Finish)

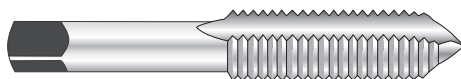

CHROME PLATED (Silver Finish)

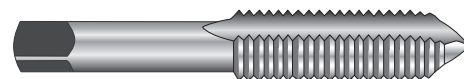

TiN COATED (Gold Finish)

High Speed Steel Spiral Point Taps are designed primarily for machine tapping in through holes with adequate bottom clearance for chips to accumulate. The cutting face of the first few threads are ground back relative to the axis of the tap to force the chips ahead of the tap. This reduces loading and clogging in flutes and allows a free flow of coolant to reach the cutting edge. The shallow straight flutes are not ground as deep as a hand tap, which gives the tap greater strength and can be run at higher speeds with less power. Ideal for tapping most ductile materials, aluminum, brass, copper die castings, soft steels, etc. They are also known as Gun Taps, Gun Nose Taps, Bull Nose Taps, or Chipdriver Taps.

Chrome Plated High Speed Steel Spiral Point Taps are plated with a very thin layer of hard chrome to produce a surface hardness of RC 72. Chrome plating reduces friction, improves lubrication, has excellent wear resistance, and prevents galling. Often used where lubrication is not possible or available. Can be operated at higher speeds. Chrome plated taps have a bright silver finish. Ideal for tapping most ferrous, non-ferrous, and non-metallic surfaces.

Titanium Nitride Coated High Speed Steel Spiral Point Taps have a bright gold coating of Titanium Nitride about .0001 thick to produce a surface hardness of RC 86. It refracts heat and acts as a thermal barrier between the chips and the tap. Titanium Nitride reduces friction and chip welding and can be operated at higher speeds. Ideal for tapping most ferrous, non-ferrous, and non-metallic materials.

THREAD SIZE	NO. OF FLUTES	LIMIT NO.	HSS UNCOATED (Bright Finish)		CHROME PLATED (Silver Finish)		TiN COATED (Gold Finish)	
			ITEM NO.	PRICE	ITEM NO.	PRICE	ITEM NO.	PRICE
0-80	2	H2	SPT#00-80PH2	-	SPTCP#00-80PH2	-	SPTT#00-80PH2	-
1-64	2	H2	SPT#01-64PH2	-	SPTCP#01-64PH2	-	SPTT#01-64PH2	-
1-72	2	H2	SPT#01-72PH2	-	SPTCP#01-72PH2	-	SPTT#01-72PH2	-
2-56	2	H2	SPT#02-56PH2	-	SPTCP#02-56PH2	-	SPTT#02-56PH2	-
2-64	2	H2	SPT#02-64PH2	-	SPTCP#02-64PH2	-	SPTT#02-64PH2	-
3-48	2	H2	SPT#03-48PH2	-	SPTCP#03-48PH2	-	SPTT#03-48PH2	-
3-56	2	H2	SPT#03-56PH2	-	SPTCP#03-56PH2	-	SPTT#03-56PH2	-
4-40	2	H2	SPT#04-40PH2	-	SPTCP#04-40PH2	-	SPTT#04-40PH2	-
4-48	2	H2	SPT#04-48PH2	-	SPTCP#04-48PH2	-	SPTT#04-48PH2	-
5-40	2	H2	SPT#05-40PH2	-	SPTCP#05-40PH2	-	SPTT#05-40PH2	-
5-44	2	H2	SPT#05-44PH2	-	SPTCP#05-44PH2	-	SPTT#05-44PH2	-
6-32	2	H3	SPT#06-32PH3	-	SPTCP#06-32PH3	-	SPTT#06-32PH3	-
6-40	2	H3	SPT#06-40PH3	-	SPTCP#06-40PH3	-	SPTT#06-40PH3	-
8-32	2	H3	SPT#08-32PH3	-	SPTCP#08-32PH3	-	SPTT#08-32PH3	-
8-36	2	H3	SPT#08-36PH3	-	SPTCP#08-36PH3	-	SPTT#08-36PH3	-
10-24	2	H3	SPT#10-24PH3	-	SPTCP#10-24PH3	-	SPTT#10-24PH3	-
10-32	2	H3	SPT#10-32PH3	CALL FOR PRICE	SPTCP#10-32PH3	CALL FOR PRICE	SPTT#10-32PH3	CALL FOR PRICE
12-24	2	H3	SPT#12-24PH3	CALL FOR PRICE	SPTCP#12-24PH3	CALL FOR PRICE	SPTT#12-24PH3	CALL FOR PRICE
12-32	2	H3	SPT#12-32PH3	CALL FOR PRICE	SPTCP#12-32PH3	CALL FOR PRICE	SPTT#12-32PH3	CALL FOR PRICE
1/4-20	2	H3	SPT016-20PH3	-	SPTCP016-20PH3	-	SPTT016-20PH3	-
1/4-28	2	H3	SPT016-28PH3	-	SPTCP016-28PH3	-	SPTT016-28PH3	-
5/16-18	2	H3	SPT020-18PH3	-	SPTCP020-18PH3	-	SPTT020-18PH3	-
5/16-24	2	H3	SPT020-24PH3	-	SPTCP020-24PH3	-	SPTT020-24PH3	-
3/8-16	3	H3	SPT024-16PH3	-	SPTCP024-16PH3	-	SPTT024-16PH3	-
3/8-24	3	H3	SPT024-24PH3	-	SPTCP024-24PH3	-	SPTT024-24PH3	-
7/16-14	3	H3	SPT028-14PH3	-	SPTCP028-14PH3	-	SPTT028-14PH3	-
7/16-20	3	H3	SPT028-20PH3	-	SPTCP028-20PH3	-	SPTT028-20PH3	-
1/2-13	3	H3	SPT032-13PH3	-	SPTCP032-13PH3	-	SPTT032-13PH3	-
1/2-20	3	H3	SPT032-20PH3	-	SPTCP032-20PH3	-	SPTT032-20PH3	-
9/16-12	3	H3	SPT036-12PH3	-	SPTCP036-12PH3	-	SPTT036-12PH3	-
9/16-18	3	H3	SPT036-18PH3	-	SPTCP036-18PH3	-	SPTT036-18PH3	-
5/8-11	3	H3	SPT040-11PH3	-	SPTCP040-11PH3	-	SPTT040-11PH3	-
5/8-18	3	H3	SPT040-18PH3	-	SPTCP040-18PH3	-	SPTT040-18PH3	-
11/16-11	3	H3	SPT044-11PH3	-	SPTCP044-11PH3	-	SPTT044-11PH3	-
11/16-16	3	H3	SPT044-16PH3	-	SPTCP044-16PH3	-	SPTT044-16PH3	-
3/4-10	3	H3	SPT048-10PH3	-	SPTCP048-10PH3	-	SPTT048-10PH3	-
3/4-16	3	H3	SPT048-16PH3	-	SPTCP048-16PH3	-	SPTT048-16PH3	-
7/8-9	3	H3	SPT056-09PH3	-	SPTCP056-09PH3	-	SPTT056-09PH3	-
7/8-14	3	H3	SPT056-14PH3	-	SPTCP056-14PH3	-	SPTT056-14PH3	-
1-8	3	H3	SPT100-08PH3	-	SPTCP100-08PH3	-	SPTT100-08PH3	-
1-12	3	H3	SPT100-12PH3	-	SPTCP100-12PH3	-	SPTT100-12PH3	-
1-14	3	H3	SPT100-14PH3	-	SPTCP100-14PH3	-	SPTT100-14PH3	-

HIGH SPEED STEEL METRIC SPIRAL POINT TAPS (GUN TAPS)

ICS **WIS**

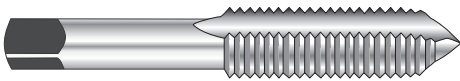

HSS UNCOATED (Bright Finish)

GENERAL PURPOSE

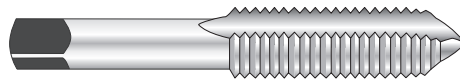

CHROME PLATED (Silver Finish)

GROUND THREAD

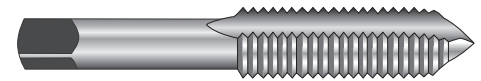

TiN COATED (Gold Finish)

High Speed Steel Metric Spiral Point Taps are designed primarily for machine tapping in through holes with adequate bottom clearance for chips to accumulate. The cutting face of the first few threads are ground back relative to the axis of the tap to force the chips ahead of the tap. This reduces loading and clogging in flutes and allows a free flow of coolant to reach the cutting edge. The shallow straight flutes are not ground as deep as a hand tap, which gives the tap greater strength and can be run at higher speeds with less power. Ideal for tapping most ductile materials, aluminum, brass, copper die castings, soft steels, etc. They are also known as Metric Gun Taps, Metric Gun Nose Taps, Metric Bull Nose Taps, or Metric Chipdriver Taps.

Chrome Plated High Speed Steel Metric Spiral Point Taps are plated with a very thin layer of hard chrome to produce a surface hardness of RC 72. Chrome plating reduces friction, improves lubrication, has excellent wear resistance, and prevents galling. Often used where lubrication is not possible or available. Can be operated at higher speeds. Chrome plated taps have a bright silver finish. Ideal for tapping most ferrous, non-ferrous, and non-metallic surfaces.

Titanium Nitride Coated High Speed Steel Metric Spiral Point Taps have a bright gold coating of Titanium Nitride about .0001 thick to produce a surface hardness of RC 86. It refracts heat and acts as a thermal barrier between the chips and the tap. Titanium Nitride reduces friction and chip welding and can be operated at higher speeds. Ideal for tapping most ferrous, non-ferrous, and non-metallic materials.

THREAD		NO. OF FLUTES	HSS UNCOATED (Bright Finish)		CHROME PLATED (Silver Finish)		TiN COATED (Gold Finish)	
SIZE	PITCH		ITEM NO.	PRICE	ITEM NO.	PRICE	ITEM NO.	PRICE
M1.6	.35	2	SPTM01.6X.35	-	SPTMCP01.6X.35	-	SPTMT01.6X.35	-
M1.8	.35	2	SPTM01.8X.35	-	SPTMCP01.8X.35	-	SPTMT01.8X.35	-
M2.0	.40	2	SPTM02.0X.40	-	SPTMCP02.0X.40	-	SPTMT02.0X.40	-
M2.2	.45	2	SPTM02.2X.45	-	SPTMCP02.2X.45	-	SPTMT02.2X.45	-
M2.5	.45	2	SPTM02.5X.45	-	SPTMCP02.5X.45	-	SPTMT02.5X.45	-
M3.0	.50	2	SPTM03.0X.50	-	SPTMCP03.0X.50	-	SPTMT03.0X.50	-
M3.5	.60	2	SPTM03.5X.60	-	SPTMCP03.5X.60	-	SPTMT03.5X.60	-
M4.0	.70	2	SPTM04.0X.70	-	SPTMCP04.0X.70	-	SPTMT04.0X.70	-
M4.5	.75	2	SPTM04.5X.75	-	SPTMCP04.5X.75	-	SPTMT04.5X.75	-
M5.0	.80	2	SPTM05.0X.80	-	SPTMCP05.0X.80	-	SPTMT05.0X.80	-
M6.0	1.00	2	SPTM06.0X1.0	-	SPTMCP06.0X1.0	-	SPTMT06.0X1.0	-
M6.3	1.00	2	SPTM06.3X1.0	CALL	SPTMCP06.3X1.0	CALL	SPTMT06.3X1.0	CALL
M7.0	1.00	2	SPTM07.0X1.0	FOR	SPTMCP07.0X1.0	FOR	SPTMT07.0X1.0	FOR
M8.0	1.25	2	SPTM08.0X1.25	PRICE	SPTMCP08.0X1.25	PRICE	SPTMT08.0X1.25	PRICE
M8.0	1.00	2	SPTM08.0X1.0	-	SPTMCP08.0X1.0	-	SPTMT08.0X1.0	-
M10.0	1.50	3	SPTM10.0X1.5	-	SPTMCP10.0X1.5	-	SPTMT10.0X1.5	-
M10.0	1.25	3	SPTM10.0X1.25	-	SPTMCP10.0X1.25	-	SPTMT10.0X1.25	-
M12.0	1.75	3	SPTM12.0X1.75	-	SPTMCP12.0X1.75	-	SPTMT12.0X1.75	-
M12.0	1.25	3	SPTM12.0X1.25	-	SPTMCP12.0X1.25	-	SPTMT12.0X1.25	-
M14.0	2.00	3	SPTM14.0X2.0	-	SPTMCP14.0X2.0	-	SPTMT14.0X2.0	-
M14.0	1.50	3	SPTM14.0X1.5	-	SPTMCP14.0X1.5	-	SPTMT14.0X1.5	-
M16.0	2.00	3	SPTM16.0X2.0	-	SPTMCP16.0X2.0	-	SPTMT16.0X2.0	-
M16.0	1.50	3	SPTM16.0X1.5	-	SPTMCP16.0X1.5	-	SPTMT16.0X1.5	-
M18.0	1.50	3	SPTM18.0X1.5	-	SPTMCP18.0X1.5	-	SPTMT18.0X1.5	-
M18.0	2.50	3	SPTM18.0X2.5	-	SPTMCP18.0X2.5	-	SPTMT18.0X2.5	-
M20.0	1.50	3	SPTM20.0X1.5	-	SPTMCP20.0X1.5	-	SPTMT20.0X1.5	-
M20.0	2.50	3	SPTM20.0X2.5	-	SPTMCP20.0X2.5	-	SPTMT20.0X2.5	-
M24.0	3.00	3	SPTM24.0X3.0	-	SPTMCP24.0X3.0	-	SPTMT24.0X3.0	-

PACKAGING

M1.6 - M14 - 12 Taps/Box

M16 - M24 - 3 Taps/Box

Metric pitches in **bold type** are **coarse thread** form.

HIGH SPEED STEEL +.005 OVERSIZE SPIRAL POINT TAPS

ICS WIS

GENERAL PURPOSE

GROUND THREAD

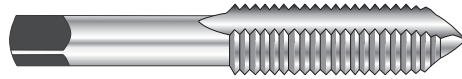

PLUG CHAMFER

Oversize Spiral Point Taps are used primarily where a piece will be plated or heat treated after tapping. They are also used when tapping plastics or zinc alloys where it is difficult to maintain the proper tapped hole size because of abrasion or shrinkage.

SIZE	NO. OF FLUTES	NC UNC - COARSE THREAD		NF UNF - FINE THREAD		NS - SPECIAL THREAD		PRICE EACH
		TPI	ITEM NO.	TPI	ITEM NO.	TPI	ITEM NO.	
4	2	40	SPTO#04-40					8.14
5	2	40	SPTO#05-40					8.34
6	2	32	SPTO#06-32					6.96
8	2	32	SPTO#08-32					6.96
10	2	24	SPTO#10-24	32	SPTO#10-32			6.96
1/4	2	20	SPTO016-20	28	SPTO016-28			6.96
5/16	2	18	SPTO020-18	24	SPTO020-24			7.50
3/8	3	16	SPTO024-16	24	SPTO024-24			9.10
7/16	3	14	SPTO028-14	20	SPTO028-20			15.26
1/2	3	13	SPTO032-13	20	SPTO032-20			15.52
5/8	3	11	SPTO040-11	18	SPTO040-18			29.86
3/4	3	10	SPTO048-10	16	SPTO048-16			41.90
7/8	3	9	SPTO056-09	14	SPTO056-14			57.58
1	3	8	SPTO100-08	12	SPTO100-12	14	SPTO100-14	77.18

COBALT SPIRAL POINT TAPS

ICS WIS

HEAVY DUTY

GROUND THREAD

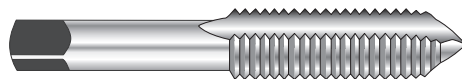

PLUG CHAMFER

Cobalt Spiral Point Taps are designed for tapping difficult applications such as heat treated steels up to 45 RC, tool steels, and other tough alloys.

SIZE	NO. OF FLUTES	LIMIT NO	NC UNC - COARSE THREAD		NF UNF - FINE THREAD		PRICE EACH
			TPI	ITEM NO.	TPI	ITEM NO.	
2	2	H3	56	SPTC#02-56	64	SPTC#02-64	12.88
3	2	H3	48	SPTC#03-48	56	SPTC#03-56	12.88
4	2	H3	40	SPTC#04-40	48	SPTC#04-48	11.26
6	2	H3	40	SPTC#06-40	32	SPTC#06-32	11.26
8	2	H3	32	SPTC#08-32	36	SPTC#08-36	11.26
10	2	H3	24	SPTC#10-24	32	SPTC#10-32	11.26
1/4	2	H3	20	SPTC016-20	28	SPTC016-28	12.60
5/16	2	H3	18	SPTC020-18	24	SPTC020-24	14.70
3/8	3	H3	16	SPTC024-16	24	SPTC024-24	17.18
7/16	3	H3	14	SPTC028-14	20	SPTC028-20	18.90
1/2	3	H3	13	SPTC032-13	20	SPTC032-20	20.36
5/8	3	H3	11	SPTC040-11	18	SPTC040-18	47.66
3/4	3	H3	10	SPTC048-10	16	SPTC048-16	72.30

HIGH SPEED STEEL SPIRAL POINT EXTENSION TAPS

ICS WIS

SPECIAL PURPOSE

GROUND THREAD

DROP THRU SHANK



PLUG CHAMFER

Spiral Point Extension Taps are designed for deep hole tapping where the work requires an undercut shank to follow through hole.

SIZE	NO. OF FLUTES	LIMIT NO	NC UNC - COARSE THREAD		NF UNF - FINE THREAD		PRICE EACH	NC UNC - COARSE THREAD		NF UNF - FINE THREAD		PRICE EACH
			TPI	ITEM NO.	TPI	ITEM NO.		TPI	ITEM NO.	TPI	ITEM NO.	
6	2	H3	32	SPET#06-32X06			30.92	32	SPET#06-32X12			-
8	2	H3	32	SPET#08-32X06			30.92	32	SPET#08-32X12			-
10	2	H3	24	SPET#10-24X06	32	SPET#10-32X06	30.92	24	SPET#10-24X12	32	SPET#10-32X12	CALL FOR PRICE
1/4	2	H3	20	SPET016-20X06	28	SPET016-28X06	30.92	20	SPET016-20X12	28	SPET016-28X12	FOR PRICE
5/16	2	H3	18	SPET020-18X06	24	SPET020-24X06	39.20	18	SPET020-18X12	24	SPET020-24X12	-
3/8	3	H3	16	SPET024-16X06	24	SPET024-24X06	43.90	16	SPET024-16X12	24	SPET024-24X12	-
7/16	3	H3	14	SPET028-14X06	20	SPET028-20X06	44.46	14	SPET028-14X12	20	SPET028-20X12	-
1/2	3	H3	13	SPET032-13X06	20	SPET032-20X06	46.98	13	SPET032-13X12	20	SPET032-20X12	-

**PREMIUM (10% COBALT) MICROGRAIN
SOLID CARBIDE SPIRAL POINT TAPS**

ICS USA

HEAVY DUTY

CNC GROUND

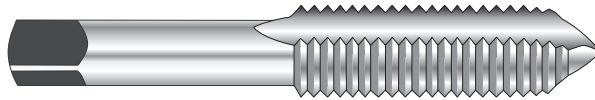

**PLUG
CHAMFER**

Micrograin Solid Carbide Spiral Point Taps are designed for machine tapping through holes or blind holes in difficult to machine materials and tough work hardening metals such as stainless steel, titanium alloys, Inconel, powdered metals, cast iron, plastics, and steels up to Rockwell hardness C45. Used whenever high speed steel spiral point taps cannot handle the job. Solid Carbide Spiral Point Taps have a plug chamfer and must have a rigid setup for use. Do not use for hand tapping.

SIZE	THREADS PER INCH	NO. OF FLUTES	LIMIT NO.	ITEM NO.	PRICE
6	32	2	H3	SCSPT#06-32	-
8	32	2	H3	SCSPT#08-32	-
10	24	2	H3	SCSPT#10-24	-
10	32	2	H3	SCSPT#10-32	-
12	24	2	H3	SCSPT#12-24	-
12	28	2	H3	SCSPT#12-28	CALL
1/4	20	2	H3	SCSPT016-20	FOR
1/4	28	2	H3	SCSPT016-28	PRICE
5/16	18	2	H3	SCSPT020-18	-
5/16	24	2	H3	SCSPT020-24	-
3/8	16	3	H3	SCSPT024-16	-
3/8	24	3	H3	SCSPT024-24	-
7/16	14	3	H3	SCSPT028-14	-
7/16	20	3	H3	SCSPT028-20	-

Special Thread Solid Carbide Spiral Point Taps can be made to your requirements. Consult factory for price and quick delivery.

**PREMIUM (10% COBALT) MICROGRAIN
SOLID CARBIDE TAPER (NPT) PIPE TAPS**

ICS USA

HEAVY DUTY

CNC GROUND

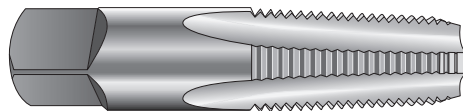

Micrograin Solid Carbide Taper Pipe Taps are designed to tap pipe fittings made of difficult to machine materials and tough work hardening metals such as stainless steel, titanium alloys, Inconel, powdered metals, cast iron, plastics, and steels up to Rockwell hardness C45. Use when high speed steel taper pipe taps (NPT) cannot handle the job. Solid Carbide Taper Pipe Taps (NPT) have a taper chamfer and must have a rigid setup for use.

SIZE	THREADS PER INCH	NO. OF FLUTES	ITEM NO.	PRICE
1/4	18	4	SCNPT016-18	-
3/8	18	4	SCNPT024-18	CALL
1/2	14	4	SCNPT032-18	FOR
3/4	14	5	SCNPT048-14	PRICE
1	11-1/2	5	SCNPT100-11.5	-

PREMIUM (10% COBALT) MICROGRAIN SOLID CARBIDE HAND TAPS

ICS USA

HEAVY DUTY

CNC GROUND

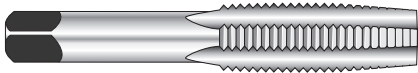

TAPER TAP
7-10 Thread Chamfer
at 5 degrees per side

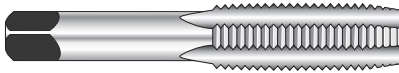

PLUG TAP
3-5 Thread Chamfer
at 8 degrees per side

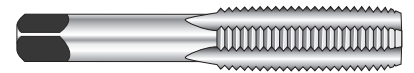

BOTTOMING TAP
1-2 Thread Chamfer
at 18 degrees per side

Micrograin Solid Carbide Hand Taps are designed for threading difficult to machine materials and tough work hardening metals such as stainless steel, titanium alloys, Inconel, powdered metals, cast iron, plastics, and steels up to Rockwell hardness C45. Used whenever high speed steel hand taps cannot handle the job. Solid Carbide Hand Taps must have a rigid setup for use.

Right Hand Thread Sizes (#6 to 5/8" Dia.)

SIZE	THREADS PER INCH	NO. OF FLUTES	LIMIT NO.	ITEM NO.		
				(TAPER)	(PLUG)	(BOTTOMING)
6	32	3	H3	SCHT#06-32T	SCHT#06-32P	SCHT#06-32B
8	32	4	H3	SCHT#08-32T	SCHT#08-32P	SCHT#08-32B
10	24	4	H3	SCHT#10-24T	SCHT#10-24P	SCHT#10-24B
10	32	4	H3	SCHT#10-32T	SCHT#10-32P	SCHT#10-32B
12	24	4	H3	SCHT#12-24T	SCHT#12-24P	SCHT#12-24B
12	28	4	H3	SCHT#12-28T	SCHT#12-28P	SCHT#12-28B
12	32	4	H3	SCHT#12-32T	SCHT#12-32P	SCHT#12-32B
1/4	20	4	H3	SCHT016-20T	SCHT016-20P	SCHT016-20B
1/4	28	4	H3	SCHT016-28T	SCHT016-28P	SCHT016-28B
1/4	32	4	H3	SCHT016-32T	SCHT016-32P	SCHT016-32B
5/16	18	4	H3	SCHT020-18T	SCHT020-18P	SCHT020-18B
5/16	24	4	H3	SCHT020-24T	SCHT020-24P	SCHT020-24B
5/16	32	4	H3	SCHT020-32T	SCHT020-32P	SCHT020-32B
3/8	16	4	H3	SCHT024-16T	SCHT024-16P	SCHT024-16B
3/8	24	4	H3	SCHT024-24T	SCHT024-24P	SCHT024-24B
3/8	32	4	H3	SCHT024-32T	SCHT024-32P	SCHT024-32B
7/16	14	4	H3	SCHT028-14T	SCHT028-14P	SCHT028-14B
7/16	20	4	H3	SCHT028-20T	SCHT028-20P	SCHT028-20B
7/16	28	4	H3	SCHT028-28T	SCHT028-28P	SCHT028-28B
1/2	13	4	H3	SCHT032-13T	SCHT032-13P	SCHT032-13B
1/2	20	4	H3	SCHT032-20T	SCHT032-20P	SCHT032-20B
1/2	28	4	H3	SCHT032-28T	SCHT032-28P	SCHT032-28B
9/16	12	4	H3	SCHT036-12T	SCHT036-12P	SCHT036-12B
9/16	18	4	H3	SCHT036-18T	SCHT036-18P	SCHT036-18B
5/8	11	4	H3	SCHT040-11T	SCHT040-11P	SCHT040-11B
5/8	18	4	H3	SCHT040-18T	SCHT040-18P	SCHT040-18B

Left Hand Thread Sizes (#6 to 5/8" Dia.)

SIZE	THREADS PER INCH	NO. OF FLUTES	LIMIT NO.	ITEM NO.		
				(TAPER)	(PLUG)	(BOTTOMING)
6	32	3	H3	SCHTL#06-32T	SCHTL#06-32P	SCHTL#06-32B
8	32	4	H3	SCHTL#08-32T	SCHTL#08-32P	SCHTL#08-32B
10	24	4	H3	SCHTL#10-24T	SCHTL#10-24P	SCHTL#10-24B
10	32	4	H3	SCHTL#10-32T	SCHTL#10-32P	SCHTL#10-32B
12	24	4	H3	SCHTL#12-24T	SCHTL#12-24P	SCHTL#12-24B
12	28	4	H3	SCHTL#12-28T	SCHTL#12-28P	SCHTL#12-28B
12	32	4	H3	SCHTL#12-32T	SCHTL#12-32P	SCHTL#12-32B
1/4	20	4	H3	SCHTL016-20T	SCHTL016-20P	SCHTL016-20B
1/4	28	4	H3	SCHTL016-28T	SCHTL016-28P	SCHTL016-28B
1/4	32	4	H3	SCHTL016-32T	SCHTL016-32P	SCHTL016-32B
5/16	18	4	H3	SCHTL020-18T	SCHTL020-18P	SCHTL020-18B
5/16	24	4	H3	SCHTL020-24T	SCHTL020-24P	SCHTL020-24B
5/16	32	4	H3	SCHTL020-32T	SCHTL020-32P	SCHTL020-32B
3/8	16	4	H3	SCHTL024-16T	SCHTL024-16P	SCHTL024-16B
3/8	24	4	H3	SCHTL024-24T	SCHTL024-24P	SCHTL024-24B
3/8	32	4	H3	SCHTL024-32T	SCHTL024-32P	SCHTL024-32B
7/16	14	4	H3	SCHTL028-14T	SCHTL028-14P	SCHTL028-14B
7/16	20	4	H3	SCHTL028-20T	SCHTL028-20P	SCHTL028-20B
7/16	28	4	H3	SCHTL028-28T	SCHTL028-28P	SCHTL028-28B
1/2	13	4	H3	SCHTL032-13T	SCHTL032-13P	SCHTL032-13B
1/2	20	4	H3	SCHTL032-20T	SCHTL032-20P	SCHTL032-20B
1/2	28	4	H3	SCHTL032-28T	SCHTL032-28P	SCHTL032-28B
9/16	12	4	H3	SCHTL036-12T	SCHTL036-12P	SCHTL036-12B
9/16	18	4	H3	SCHTL036-18T	SCHTL036-18P	SCHTL036-18B
5/8	11	4	H3	SCHTL040-11T	SCHTL040-11P	SCHTL040-11B
5/8	18	4	H3	SCHTL040-18T	SCHTL040-18P	SCHTL040-18B

PREMIUM (10% COBALT) MICROGRAIN
SOLID CARBIDE METRIC HAND TAPS

ICS USA

HEAVY DUTY

CNC GROUND

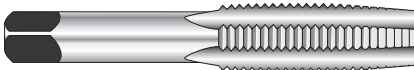

TAPER TAP
7-10 Thread Chamfer
at 5 degrees per side

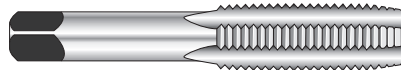

PLUG TAP
3-5 Thread Chamfer
at 8 degrees per side

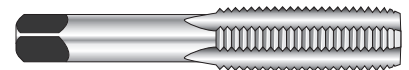

BOTTOMING TAP
1-2 Thread Chamfer
at 18 degrees per side

Micrograin Solid Carbide Metric Hand Taps are designed for threading difficult to machine materials and tough work hardening metals such as stainless steel, titanium alloys, Inconel, powdered metals, cast iron, plastics, and steels up to Rockwell hardness C45. Used whenever high speed steel hand taps cannot handle the job. Solid Carbide Hand Taps must have a rigid setup for use.

Right Hand Metric Thread Sizes (3.50mm to 16.00mm Dia.)

SIZE	PITCH	NO. OF FLUTES	LIMIT NO.	ITEM NO.		
				(TAPER)	(PLUG)	(BOTTOMING)
M3.5	0.60	3	H3	SCHTM03.5X.60T	SCHTM03.5X.60P	SCHTM03.5X.60B
M4.0	0.70	4	H3	SCHTM04.0X.70T	SCHTM04.0X.70P	SCHTM04.0X.70B
M4.5	0.75	4	H3	SCHTM04.5X.75T	SCHTM04.5X.75P	SCHTM04.5X.75B
M5.0	0.80	4	H3	SCHTM05.0X.80T	SCHTM05.0X.80P	SCHTM05.0X.80B
M5.0	0.90	4	H3	SCHTM05.0X.90T	SCHTM05.0X.90P	SCHTM05.0X.90B
M6.0	1	4	H3	SCHTM06.0X1.0T	SCHTM06.0X1.0P	SCHTM06.0X1.0B
M6.3	1	4	H3	SCHTM06.3X1.0T	SCHTM06.3X1.0P	SCHTM06.3X1.0B
M7.0	1	4	H3	SCHTM07X1.00T	SCHTM07X1.00P	SCHTM07X1.00B
M8.0	1	4	H3	SCHTM08X1.00T	SCHTM08X1.00P	SCHTM08X1.00B
M8.0	1.25	4	H3	SCHTM08X1.25T	SCHTM08X1.25P	SCHTM08X1.25B
M9.0	1.25	4	H3	SCHTM09X1.25T	SCHTM09X1.25P	SCHTM09X1.25B
M10	1	4	H3	SCHTM10X1.00T	SCHTM10X1.00P	SCHTM10X1.00B
M10	1.25	4	H3	SCHTM10X1.25T	SCHTM10X1.25P	SCHTM10X1.25B
M10	1.50	4	H3	SCHTM10X1.50T	SCHTM10X1.50P	SCHTM10X1.50B
M12	1.25	4	H3	SCHTM12X1.25T	SCHTM12X1.25P	SCHTM12X1.25B
M12	1.50	4	H3	SCHTM12X1.50T	SCHTM12X1.50P	SCHTM12X1.50B
M12	1.75	4	H3	SCHTM12X1.75T	SCHTM12X1.75P	SCHTM12X1.75B
M14	1.25	4	H3	SCHTM14X1.25T	SCHTM14X1.25P	SCHTM14X1.25B
M14	1.50	4	H3	SCHTM14X1.50T	SCHTM14X1.50P	SCHTM14X1.50B
M14	2	4	H3	SCHTM14X2.00T	SCHTM14X2.00P	SCHTM14X2.00B
M16	1.50	4	H3	SCHTM16X1.50T	SCHTM16X1.50P	SCHTM16X1.50B
M16	2	4	H3	SCHTM16X2.00T	SCHTM16X2.00P	SCHTM16X2.00B

Left Hand Metric Thread Sizes (3.50mm to 16.00mm Dia.)

SIZE	PITCH	NO. OF FLUTES	LIMIT NO.	ITEM NO.		
				(TAPER)	(PLUG)	(BOTTOMING)
M3.5	0.60	3	H3	SCHTML03.5X.60T	SCHTML03.5X.60P	SCHTML03.5X.60B
M4.0	0.70	4	H3	SCHTML04.0X.70T	SCHTML04.0X.70P	SCHTML04.0X.70B
M4.5	0.75	4	H3	SCHTML04.5X.75T	SCHTML04.5X.75P	SCHTML04.5X.75B
M5.0	0.80	4	H3	SCHTML05.0X.80T	SCHTML05.0X.80P	SCHTML05.0X.80B
M5.0	0.90	4	H3	SCHTML05.0X.90T	SCHTML05.0X.90P	SCHTML05.0X.90B
M6.0	1	4	H3	SCHTML06.0X1.0T	SCHTML06.0X1.0P	SCHTML06.0X1.0B
M6.3	1	4	H3	SCHTML06.3X1.0T	SCHTML06.3X1.0P	SCHTML06.3X1.0B
M7.0	1	4	H3	SCHTML07X1.00T	SCHTML07X1.00P	SCHTML07X1.00B
M8.0	1	4	H3	SCHTML08X1.00T	SCHTML08X1.00P	SCHTML08X1.00B
M8.0	1.25	4	H3	SCHTML08X1.25T	SCHTML08X1.25P	SCHTML08X1.25B
M9.0	1.25	4	H3	SCHTML09X1.25T	SCHTML09X1.25P	SCHTML09X1.25B
M10	1	4	H3	SCHTML10X1.00T	SCHTML10X1.00P	SCHTML10X1.00B
M10	1.25	4	H3	SCHTML10X1.25T	SCHTML10X1.25P	SCHTML10X1.25B
M10	1.50	4	H3	SCHTML10X1.50T	SCHTML10X1.50P	SCHTML10X1.50B
M12	1.25	4	H3	SCHTML12X1.25T	SCHTML12X1.25P	SCHTML12X1.25B
M12	1.50	4	H3	SCHTML12X1.50T	SCHTML12X1.50P	SCHTML12X1.50B
M12	1.75	4	H3	SCHTML12X1.75T	SCHTML12X1.75P	SCHTML12X1.75B
M14	1.25	4	H3	SCHTML14X1.25T	SCHTML14X1.25P	SCHTML14X1.25B
M14	1.50	4	H3	SCHTML14X1.50T	SCHTML14X1.50P	SCHTML14X1.50B
M14	2	4	H3	SCHTML14X2.00T	SCHTML14X2.00P	SCHTML14X2.00B
M16	1.50	4	H3	SCHTML16X1.50T	SCHTML16X1.50P	SCHTML16X1.50B
M16	2	4	H3	SCHTML16X2.00T	SCHTML16X2.00P	SCHTML16X2.00B

CALL FOR PRICING

Metric pitches in **bold type** are **coarse thread** form.

- Special Thread Solid Carbide Metric Hand Taps can be made to your requirements. Consult factory for price and quick delivery.

HIGH PERFORMANCE SPIRAL POINT TAPS

ICS USA

SPECIAL PURPOSE

GROUND THREAD

STEAM OXIDE FINISH



PLUG CHAMFER

Premium Vanadium High Speed High Performance Spiral Point Taps are designed for through hole tapping in heat treated steels up to 45 RC, tough alloys, and stainless steels. They are manufactured with a reduced neck design specifically for use on CNC equipment.

SIZE	THREADS PER INCH	NO. OF FLUTES	LIMIT NO.	ITEM NO. (TAPER)	PRICE
4	40	2	2	HPSPT#04-40	15.76
6	32	2	2	HPSPT#06-32	13.12
8	32	3	3	HPSPT#08-32	13.12
10	24	3	3	HPSPT#10-24	13.12
10	32	3	3	HPSPT#10-32	13.12
1/4	20	3	3	HPSPT016-20	14.56
1/4	28	3	3	HPSPT016-28	14.56
5/16	18	3	3	HPSPT020-18	16.38
5/16	24	3	3	HPSPT020-24	16.38
3/8	16	3	3	HPSPT024-16	18.48
3/8	24	3	3	HPSPT024-24	18.48

SIZE	THREADS PER INCH	NO. OF FLUTES	LIMIT NO.	ITEM NO. (TAPER)	PRICE
7/16	14	3	3	HPSPT028-14	24.16
7/16	20	3	3	HPSPT028-20	24.16
1/2	13	3	3	HPSPT032-13	27.82
1/2	20	3	3	HPSPT032-20	27.82
5/8	11	3	3	HPSPT040-11	50.40
5/8	18	3	3	HPSPT040-18	50.40
3/4	10	3	3	HPSPT048-10	78.76
3/4	16	3	3	HPSPT048-16	78.76
7/8	9	4	4	HPSPT056-09	117.60
7/8	14	4	4	HPSPT056-14	117.60
1	8	4	4	HPSPT100-08	156.46

HSS - V PREMIUM VANADIUM

LONG LENGTH HIGH PERFORMANCE SPIRAL POINT TAPS

ICS USA

SPECIAL PURPOSE

GROUND THREAD

STEAM OXIDE FINISH



PLUG CHAMFER

Long Length Premium Vanadium High Speed High Performance Spiral Point Taps are designed for through hole tapping in heat treated steels up to 45 RC, tough alloys, and stainless steels. They are manufactured with a reduced neck design specifically for use on CNC equipment.

SIZE	TPI	NO. OF FLUTES	LIMIT NO.	OAL	ITEM NO. (TAPER)	PRICE
4	40	2	2	6	HPSPT06L#04-40	35.70
6	32	2	2	6	HPSPT06L#06-32	33.60
8	32	3	3	6	HPSPT06L#08-32	33.60
10	24	3	3	6	HPSPT06L#10-24	33.60
10	32	3	3	6	HPSPT06L#10-32	33.60
1/4	20	3	3	6	HPSPT06L016-20	34.86
1/4	28	3	3	6	HPSPT06L016-28	34.86
5/16	18	3	3	6	HPSPT06L020-18	36.34

SIZE	TPI	NO. OF FLUTES	LIMIT NO.	OAL	ITEM NO. (TAPER)	PRICE
5/16	24	3	3	6	HPSPT06L020-24	36.34
3/8	16	3	3	6	HPSPT06L024-16	37.80
3/8	24	3	3	6	HPSPT06L024-24	37.80
7/16	14	3	3	6	HPSPT06L028-14	42.00
7/16	20	3	3	6	HPSPT06L028-20	42.00
1/2	13	3	3	6	HPSPT06L032-13	45.36
1/2	20	3	3	6	HPSPT06L032-20	45.36
5/8	11	3	3	6	HPSPT06L040-11	CALL

Special Thread Solid Carbide Spiral Point Taps can be made to your requirements. Consult factory for price and quick delivery.

HSS - V PREMIUM VANADIUM

HIGH PERFORMANCE SPIRAL FLUTE TAPS

ICS USA

SPECIAL PURPOSE

GROUND THREAD

STEAM OXIDE FINISH

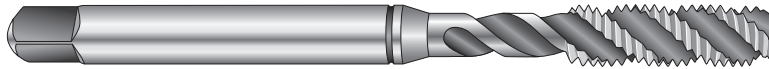

SEMI-BOTTOMING CHAMFER

Premium Vanadium High Speed High Performance Spiral Flute Taps are designed for through hole tapping in heat treated steels up to 45 RC, tough alloys, and stainless steels. Ideally suited for blind hole tapping. They are manufactured with a reduced neck design specifically for use on CNC equipment.

SIZE	THREADS PER INCH	NO. OF FLUTES	LIMIT NO.	ITEM NO. (TAPER)	PRICE
4	40	2	2	HPSFT#04-40	25.30
6	32	2	2	HPSFT#06-32	20.48
8	32	3	3	HPSFT#08-32	20.48
10	24	3	3	HPSFT#10-24	20.48
10	32	3	3	HPSFT#10-32	20.48
1/4	20	3	3	HPSFT016-20	22.24
1/4	28	3	3	HPSFT016-28	22.24
5/16	18	3	3	HPSFT020-18	27.30
5/16	24	3	3	HPSFT020-24	27.30
3/8	16	3	3	HPSFT024-16	31.74
3/8	24	3	3	HPSFT024-24	31.74

SIZE	THREADS PER INCH	NO. OF FLUTES	LIMIT NO.	ITEM NO. (TAPER)	PRICE
7/16	14	3	3	HPSFT028-14	47.42
7/16	20	3	3	HPSFT028-20	47.42
1/2	13	3	3	HPSFT032-13	55.88
1/2	20	3	3	HPSFT032-20	55.88
5/8	11	4	3	HPSFT040-11	98.44
5/8	18	4	3	HPSFT040-18	98.44
3/4	10	4	3	HPSFT048-10	126.60
3/4	16	4	3	HPSFT048-16	126.60
7/8	9	4	4	HPSFT056-09	175.78
7/8	14	4	4	HPSFT056-14	184.00
1	8	4	4	HPSFT100-08	222.48

HIGH SPEED STEEL SPIRAL POINT PULLEY TAPS

ICS **WIS**

SPECIAL PURPOSE

GROUND THREAD



**PLUG
CHAMFER**

Spiral Point Pulley Taps are used for machine tapping the hubs of pulleys for oil caps or set screws. The long shank is also ideal for reaching holes inaccessible with standard length taps. Thread length is the same length as a standard hand tap.

SIZE	NO. OF FLUTES	LIMIT NO	OVERALL LENGTH	NC UNC - COARSE THREAD		NF UNF - FINE THREAD		PRICE EACH
				TPI	ITEM NO.	TPI	ITEM NO.	
6	2	H3	6	32	SPPT#06-32			30.92
8	2	H3	6	32	SPPT#08-32			30.92
10	2	H3	6	24	SPPT#10-24	32	SPPT#10-32	30.92
1/4	2	H3	6	20	SPPT016-20	28	SPPT016-28	30.92
5/16	3	H3	6	18	SPPT020-18	24	SPPT020-24	39.20
3/8	3	H3	6	16	SPPT024-16	24	SPPT024-24	43.90
7/16	3	H3	6	14	SPPT028-14	20	SPPT028-20	44.46
1/2	3	H3	6	13	SPPT032-13	20	SPPT032-20	46.98

HIGH SPEED STEEL METRIC SPIRAL POINT PULLEY TAPS

ICS **WIS**

SPECIAL PURPOSE

GROUND THREAD



**PLUG
CHAMFER**

Metric Spiral Point Pulley Taps are used for machine tapping the hubs of pulleys for oil caps or set screws. The long shank is also ideal for reaching holes inaccessible with standard length taps. Thread length is the same length as a standard hand tap.

SIZE (mm)	PITCH (mm)	NO. OF FLUTES	OVERALL LENGTH	ITEM NO.	PRICE
M3.5	.60	2	6	SPPTM03.5X0.60	37.28
M4	.70	2	6	SPPTM04.0X0.70	37.28
M4.5	.75	2	6	SPPTM04.5X0.75	37.28
M5	.80	2	6	SPPTM05.0X0.80	37.28
M6	1.00	2	6	SPPTM06.0X1.00	37.28
M7	1.00	2	6	SPPTM07.0X1.00	40.14
M8	1.25	2	6	SPPTM08.0X1.25	40.14
M10	1.50	3	6	SPPTM10.0X1.50	43.66
M12	1.75	3	6	SPPTM10.0X1.75	43.66

HIGH SPEED STEEL PULLEY TAPS

ICS WIS

SPECIAL PURPOSE

GROUND THREAD

**6", 8", 10" & 12"
LENGTHS**



**PLUG
CHAMFER**

Pulley Taps are used for tapping the hubs of pulleys for oil caps or set screws. The long shank is also ideal for reaching holes inaccessible with standard length taps. Thread length is the same length as a standard hand tap. Tap shanks will not follow through on sizes below 7/16".

ITEM NO.		THREADS PER INCH		NO	PRICE EACH							
ALPHA PREFIX	NUMERIC SUFFIX			SIZE	NC UNC	NF UNF	NO OF FLUTES	LIMIT NO	OVERALL LENGTH			
	SIZE	- TPI	X LENGTH						6"	8"	10"	12"
PT	#05	- (TPI)	x (lgth)	5	-	40	3	H3	27.60	30.70	-	-
PT	#06	- (TPI)	x (lgth)	6	32	40	3	H3	27.60	30.70	-	-
PT	#08	- (TPI)	x (lgth)	8	32	36	4	H3	27.60	30.70	-	-
PT	#10	- (TPI)	x (lgth)	10	24	32	4	H3	27.60	30.70	-	-
PT	016	- (TPI)	x (lgth)	1/4	20	28	4	H3	34.06	30.70	37.80	57.76
PT	020	- (TPI)	x (lgth)	5/16	18	24	4	H3	38.22	40.82	47.26	59.86
PT	024	- (TPI)	x (lgth)	3/8	16	24	4	H3	40.94	45.66	53.52	63.00
PT	028	- (TPI)	x (lgth)	7/16	14	20	4	H3	41.68	54.20	58.52	74.26
PT	032	- (TPI)	x (lgth)	1/2	13	20	4	H3	61.16	54.20	75.76	90.68
PT	040	- (TPI)	x (lgth)	5/8	11	18	4	H3	89.48	75.76	94.86	111.18
PT	048	- (TPI)	x (lgth)	3/4	10	16	4	H3	85.22	102.02	116.26	132.02

HIGH SPEED STEEL METRIC PULLEY TAPS

ICS WIS

SPECIAL PURPOSE

GROUND THREAD

**6"
LENGTH**



**PLUG
CHAMFER**

Metric Pulley Taps are used for tapping the hubs of pulleys for oil caps or set screws. The long shank is also ideal for reaching holes inaccessible with standard length taps. Thread length is the same length as a standard hand tap. Tap shanks will not follow through on sizes below 7/16". (Only 12mm will follow through.)

SIZE (mm)	PITCH (mm)	NO. OF FLUTES	OVERALL LENGTH	ITEM NO.	PRICE
M3.5	.60	3	6	PTM03.5X0.60	32.68
M4	.70	4	6	PTM04.0X0.70	32.68
M4.5	.75	4	6	PTM04.5X0.75	32.68
M5	.80	4	6	PTM05.0X0.80	32.68
M6	1.00	4	6	PTM06.0X1.00	32.68
M7	1.00	4	6	PTM07.0X1.00	34.92
M8	1.25	4	6	PTM08.0X1.25	34.92
M10	1.50	4	6	PTM10.0X1.50	38.46
M12	1.75	4	6	PTM12.0X1.75	49.00

HIGH SPEED STEEL NUT TAPS

ICS WIS

SPECIAL PURPOSE

GROUND THREAD

**DROP THRU
SHANK**



**TAPER
CHAMFER**

Nut taps, as the name implies, were designed for tapping nuts. Now most large production nut tapping jobs are done with bent shank nut taps. These taps are now used mainly for deep hole tapping where the work requires a tap with a long undercut shank and greater thread length.

SIZE	NO OF FLUTES	LIMIT. NO	OVERALL LENGTH	NC UNC - COARSE THREAD			NF UNF - FINE THREAD			PRICE EACH
				TPI	THREAD LENGTH	ITEM NO.	TPI	THREAD LENGTH	ITEM NO.	
1/4	4	H3	5	20	1-5/8	NT016-20	28	1-5/8	NT016-28	38.50
5/16	4	H3	5-1/2	18	1-13/16	NT020-18	24	1-13/16	NT020-24	44.06
3/8	4	H3	6	16	2	NT024-16	24	2	NT024-24	51.66
7/16	4	H3	6-1/2	14	2-3/8	NT028-14	20	2-3/8	NT028-20	55.02
1/2	4	H3	7	13	2-1/2	NT032-13	20	2-1/2	NT032-20	68.78
9/16	4	H3	7-3/4	12	2-3/4	NT036-12	18	2-3/4	NT036-18	82.54
5/8	4	H3	8-1/4	11	3	NT040-11	18	3	NT040-18	90.78
3/4	4	H3	9	10	3-3/4	NT048-10	16	3-3/4	NT048-16	110.26

HIGH SPEED STEEL SPIRAL FLUTED (FAST) TAPS

ICS **WIS**

SPECIAL PURPOSE

GROUND THREAD

**FAST SPIRAL
(APPROX. 52°)**

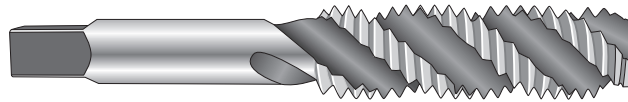

**PLUG & BOTTOMING
CHAMFER**

Fast Spiral Fluted Taps have continuous spiral flutes to lift and discharge chips from deep blind holes in softer metals.

SIZE	THREADS PER INCH		NO. OF FLUTES	LIMIT NO.	PRICE	
	NC UNC	NF UNF			HSS	SFTF
	4	40			-	2
5	40	-	2	H2	14.84	
6	32	-	2	H3	12.00	
8	32	-	3	H3	12.00	
10	24	32	3	H3	12.00	
12	24	-	3	H3	12.00	

SIZE	THREADS PER INCH		NO. OF FLUTES	LIMIT NO.	PRICE	
	NC UNC	NF UNF			HSS	SFTF
	1/4	20			28	3
5/16	18	24	3	H3	16.36	
3/8	16	24	3	H3	18.54	
7/16	14	20	3	H3	27.70	
1/2	13	20	3	H3	33.42	
5/8	11	18	4	H3	51.70	
3/4	10	16	4	H3	66.36	

HIGH SPEED STEEL SPIRAL FLUTED (REGULAR) TAPS

ICS **WIS**

SPECIAL PURPOSE

GROUND THREAD

**REGULAR SPIRAL
(APPROX. 30°)**

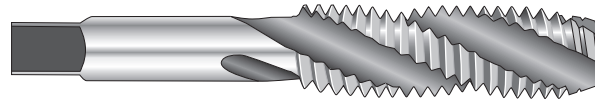

**PLUG & BOTTOMING
CHAMFER**

Regular Spiral Fluted Taps have continuous 30° spiral flutes to lift and discharge chips from deep blind holes in steels and tough grades of aluminum.

SIZE	THREADS PER INCH		NO. OF FLUTES	LIMIT NO.	PRICE	
	NC UNC	NF UNF			HSS	SFTR
	4	40			-	2
5	40	-	2	H2	14.84	
6	32	-	2	H3	12.00	
8	32	-	3	H3	12.00	
10	24	32	3	H3	12.00	
12	24	-	3	H3	12.00	

SIZE	THREADS PER INCH		NO. OF FLUTES	LIMIT NO.	PRICE	
	NC UNC	NF UNF			HSS	SFTR
	1/4	20			28	3
5/16	18	24	3	H3	16.36	
3/8	16	24	3	H3	18.54	
7/16	14	20	3	H3	27.70	
1/2	13	20	3	H3	33.42	
5/8	11	18	4	H3	51.70	
3/4	10	16	4	H3	66.36	

HIGH SPEED STEEL - TITANIUM NITRIDE COATED THREAD FORMING TAPS

ICS WIS

SPECIAL PURPOSE

GROUND THREAD

**CLASS 2B
FIT**

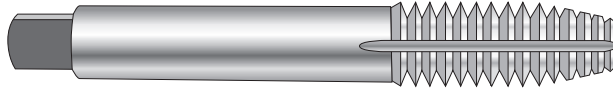

**PLUG & BOTTOMING
CHAMFER**

Thread Forming Taps are designed for cold forming threads in ductile materials such as aluminum, copper, brass, zinc, low carbon steels, and 302, 303 stainless steels. They displace metal rather than remove it, therefore, countersinking before or after tapping is recommended.

SIZE	THREADS PER INCH		LIMIT NO.	PRICE EACH		TAP DRILL SIZE APPROX. 75% THREAD	
	NC	NF		HSS	TiN COATED	NC	NF
				TFT	TFTT		
* 0	-	80	H2	19.90	22.24	-	M1.35
* 1	64	72	H2	19.90	22.24	#52	M1.65
* 2	56	64	H2	19.90	22.24	M1.95	5/64
* 3	48	56	H2	19.90	22.24	M2.25	#43
4	40	48	H3	18.24	20.58	#39	#38
5	40	-	H3	18.24	20.58	#34	-
6	32	40	H3	15.12	17.48	M3.10	1/8
8	32	36	H3	15.12	19.34	M3.75	#25
10	24	32	H4	15.12	19.34	M4.30	M4.40
12	24	28	H4	14.84	19.08	#10	M5.00
1/4	20	28	H4	14.84	19.08	M5.70	M5.80
5/16	18	24	H5	17.62	24.10	M7.20	M7.40
3/8	16	24	H5	19.90	26.36	M8.70	M9.00
7/16	14	20	H5	31.12	37.60	"X"	"Z"
1/2	13	20	H5	35.18	41.64	M11.70	M12.00
9/16	12	18	H7	40.32	52.08	33/64	M13.50
5/8	11	18	H7	49.58	61.34	37/64	19/32
3/4	10	16	H7	65.40	78.34	M17.75	23/32

* Available in Bottoming Chamfer only.

CARBON STEEL
AUTOMOTIVE RETHREADING TAPS

ICS USA

GENERAL PURPOSE

CUT THREAD

HEX SHANK

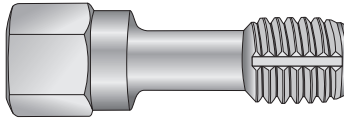

Automotive Rethreading Taps are used to repair and clean out damaged internal threads without undercutting good threads. Good for removing nicks and burs. They are not designed for cutting new threads or renewing hardened threads.

Fractional Sizes (1/4" to 9/16" Dia.)

SIZE	THREADS PER INCH	HEX SHANK	ITEM NO.	PRICE
1/4	20	7/16	ART016-20	2.98
1/4	28	7/16	ART016-28	2.98
5/16	18	7/16	ART020-18	3.10
5/16	24	7/16	ART020-24	3.10
3/8	16	1/2	ART024-16	3.28
3/8	24	1/2	ART024-24	3.28

SIZE	THREADS PER INCH	HEX SHANK	ITEM NO.	PRICE
7/16	14	1/2	ART028-14	3.36
7/16	20	1/2	ART028-20	3.36
1/2	13	5/8	ART032-13	4.02
1/2	20	5/8	ART032-20	4.02
9/16	12	5/8	ART036-12	4.12
9/16	18	5/8	ART036-18	4.12

Metric Sizes (6.0mm To 14.0mm Dia.)

SIZE	PITCH	HEX SHANK	ITEM NO.	PRICE
M6	1.00	7/16	ARTM06.0X1.00	3.10
M8	1.25	7/16	ARTM08.0X1.25	3.18
M8	1.50	7/16	ARTM08.0X1.50	3.18
M10	1.00	1/2	ARTM10.0X1.00	3.64
M10	1.25	1/2	ARTM10.0X1.25	3.64
M10	1.50	1/2	ARTM10.0X1.50	3.64

SIZE	PITCH	HEX SHANK	ITEM NO.	PRICE
M11	1.50	1/2	ARTM11.0X1.50	4.30
M12	1.25	1/2	ARTM12.0X1.25	4.30
M12	1.50	1/2	ARTM12.0X1.50	4.30
M12	1.75	1/2	ARTM12.0X1.75	4.30
M14	1.25	5/8	ARTM14.0X1.25	4.48
M14	1.50	5/8	ARTM14.0X1.50	4.48

CARBON STEEL
METRIC SPARK PLUG TAPS

ICS USA

SPECIAL PURPOSE

CUT THREAD

PLUG CHAMFER

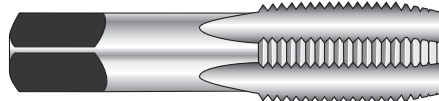

Carbon Steel Metric Spark Plug Taps are designed to clean threads of carbon build-up, metal particles, dirt, and for rethreading damaged threads so that the spark plug can fit properly in the spark plug hole.

SIZE	PITCH	FLUTES	ITEM NO.	PRICE
M10	1.00	4	CSPTM10.0X1.00	4.16
M12	1.25	4	CSPTM12.0X1.25	4.50
M14	1.25	4	CSPTM14.0X1.25	6.20
M18	1.50	4	CSPTM18.0X1.50	8.10

CARBON STEEL
METRIC SPARK PLUG TAP - DOUBLE END

ICS USA

SPECIAL PURPOSE

CUT THREAD

**M18 x 1.50
THREAD SIZE**

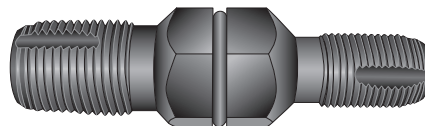

**M14 x 1.25
THREAD SIZE**

Carbon Steel Double End Metric Spark Plug Taps are designed to clean threads of carbon build-up, metal particles, and dirt. Two sizes in one. Tap services most autos. Rubber ring holds tap firmly in 13/16" socket.

SPARK PLUG THREAD SIZES	SOCKET SIZE	ITEM NO.	PRICE
M14 x 1.25 • M18 x 1.50	13/16	SPRTM14X18	14.18

HIGH SPEED STEEL THREADLOCK PLUG GAUGES

TT-32

ICS WIS

SPECIAL PURPOSE

PRECISION GROUND



CLASS 2B

Taperlock Thread Plug Gauges are designed for inspecting internal threads for rejection or acceptance of the finished threaded product. The GO end (member) is longer than the NO GO (H1) end and has a chip groove to clean out debris such as chips and dirt. Taper Shank Thread Plugs are designed to lock into taper holes in the handle. Double End GO and NO GO Threadlock Plug Gauges pricing includes handle.

THREAD SIZE	PITCH DIAMETERS		ITEM NO.	PRICE
	GO min. (Basic)	NO GO (H1) (Maximum)		
	All Classes	Unified 2B		
0-80	.0519	.0542	TTPGDE2B#00-80	89.92
1-64	.0629	.0655	TTPGDE2B#01-64	77.94
1-72	.0640	.0665	TTPGDE2B#01-72	86.92
2-56	.0744	.0772	TTPGDE2B#02-56	63.00
2-64	.0759	.0786	TTPGDE2B#02-56	70.44
3-48	.0855	.0885	TTPGDE2B#03-48	60.90
3-56	.0874	.0902	TTPGDE2B#03-56	70.44
4-40	.0958	.0991	TTPGDE2B#04-40	52.42
4-48	.0985	.1016	TTPGDE2B#04-48	52.42
5-40	.1088	.1121	TTPGDE2B#05-40	52.42
5-44	.1102	.1134	TTPGDE2B#05-44	52.42
6-32	.1177	.1214	TTPGDE2B#06-32	52.42
6-40	.1218	.1252	TTPGDE2B#06-40	52.42
8-32	.1437	.1475	TTPGDE2B#08-32	52.42
8-36	.1460	.1496	TTPGDE2B#08-36	52.42
10-24	.1629	.1672	TTPGDE2B#10-24	52.42
10-32	.1697	.1736	TTPGDE2B#10-32	52.42
12-24	.1889	.1933	TTPGDE2B#12-24	52.42
12-28	.1928	.1970	TTPGDE2B#12-28	52.42
1/4-20	.2175	.2224	TTPGDE2B016-20	48.38
1/4-28	.2268	.2311	TTPGDE2B016-28	52.42
1/4-32	.2297	.2339	TTPGDE2B016-32	52.42
5/16-18	.2764	.2817	TTPGDE2B020-18	48.38
5/16-24	.2854	.2902	TTPGDE2B020-24	52.42

THREAD SIZE	PITCH DIAMETERS		ITEM NO.	PRICE
	GO min. (Basic)	NO GO (H1) (Maximum)		
	All Classes	Unified 2B		
5/16-32	.2922	.2964	TTPGDE2B020-32	63.00
3/8-16	.3344	.3401	TTPGDE2B024-16	52.42
3/8-24	.3479	.3528	TTPGDE2B024-24	52.42
3/8-32	.3547	.3591	TTPGDE2B024-32	63.00
7/16-14	.3911	.3972	TTPGDE2B028-14	52.42
7/16-20	.4050	.4104	TTPGDE2B028-20	52.42
7/16-28	.4143	.4189	TTPGDE2B028-28	63.00
1/2-13	.4500	.4565	TTPGDE2B032-13	55.90
1/2-20	.4675	.4731	TTPGDE2B032-20	55.90
1/2-28	.4768	.4816	TTPGDE2B032-28	67.10
9/16-12	.5084	.5152	TTPGDE2B036-12	67.10
9/16-18	.5264	.5323	TTPGDE2B036-18	67.10
9/16-24	.5354	.5405	TTPGDE2B036-24	79.38
5/8-11	.5660	.5732	TTPGDE2B040-11	70.88
5/8-18	.5889	.5949	TTPGDE2B040-18	70.88
5/8-24	.5979	.6031	TTPGDE2B040-24	96.40
3/4-10	.6850	.6927	TTPGDE2B048-10	77.18
3/4-16	.7094	.7159	TTPGDE2B048-16	77.18
3/4-20	.7175	.7232	TTPGDE2B048-20	96.40
7/8-9	.8028	.8110	TTPGDE2B056-09	82.96
7/8-14	.8286	.8356	TTPGDE2B056-14	82.96
7/8-20	.8425	.8482	TTPGDE2B056-20	109.00
1-8	.9188	.9276	TTPGDE2B100-08	89.26
1-12	.9459	.9535	TTPGDE2B100-12	89.26

All Taperlock Thread Gauges conform to ANSI B1.2 screw thread standards with class "X" tolerance in every respect.

ICS can also supply the following standard and special screw gauges to your specifications.

- Extra Length
- Acme
- Modified Acme
- Metric
- BSW, BSF, Whitworth
- Special Thread Forms
- Left Hand
- Double Lead
- Triple Lead
- NPSL, NPSM, NPSF, ANPT

HIGH SPEED STEEL TANDEM "ACME" THREAD TAPS

ICS USA

SPECIAL PURPOSE

GROUND THREAD

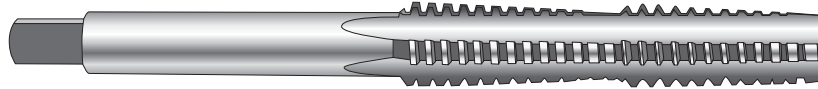
ROUGHING AND
FINISHINGCLASS
2G FIT

High Speed Steel Tandem Acme Thread Taps are designed with a roughing and finishing section to produce threads from a 10° to 30° included angle in a single pass without a leadscrew. The last few threads on the roughing section act as a guide for the finishing section, which corrects the thread angles and size. The original purpose of Acme threads was to convert rotary motion to traversing motion on machine leadscrews, valves, jack lift screws, drive gears and other mechanisms where heavy loads are encountered. They have four flutes and are to be used for through holes only. Designed to produce a class 2G thread fit.

Right Hand Thread Sizes (3/8" to 2" Dia.)

THREAD SIZE	THREAD LENGTH	OVERALL LENGTH	ITEM NO.
3/8 - 12	2-1/2	5	TAT024-12
1/2 - 10	2-9/16	5	TAT032-10
5/8 - 8	3-3/16	6-1/4	TAT040-08
3/4 - 6	4-5/16	7-15/16	TAT048-06
3/4 - 8	4-15/16	7-15/16	TAT048-08
7/8 - 6	4-3/8	8-5/8	TAT056-06

THREAD SIZE	THREAD LENGTH	OVERALL LENGTH	ITEM NO.
1 - 5	5-1/4	10-1/8	TAT100-05
1-1/8 - 5	5-1/4	10-3/4	TAT108-05
1-1/4 - 5	5-1/4	11-1/8	TAT116-05
1-3/8 - 4	5-7/8	12-1/4	TAT124-04
1-1/2 - 4	5-7/8	12-5/8	TAT132-04
2 - 4	6-1/2	14-7/8	TAT200-04

CALL FOR PRICE

Left Hand Thread Sizes (3/8" to 2" Dia.)

THREAD SIZE	THREAD LENGTH	OVERALL LENGTH	ITEM NO.
3/8 - 12	2-1/2	5	TATL024-12
1/2 - 10	2-9/16	5	TATL032-10
5/8 - 8	3-3/16	6-1/4	TATL040-08
3/4 - 6	4-5/16	7-15/16	TATL048-06
3/4 - 8	4-15/16	7-15/16	TATL048-08
7/8 - 6	4-3/8	8-5/8	TATL056-06

THREAD SIZE	THREAD LENGTH	OVERALL LENGTH	ITEM NO.
1 - 5	5-1/4	10-1/8	TATL100-05
1-1/8 - 5	5-1/4	10-3/4	TATL108-05
1-1/4 - 5	5-1/4	11-1/8	TATL116-05
1-3/8 - 4	5-7/8	12-1/4	TATL124-04
1-1/2 - 4	5-7/8	12-5/8	TATL132-04
2 - 4	6-1/2	14-7/8	TATL200-04

CALL FOR PRICE

- Acme Hexagon Rethreading Dies are also available.

TANDEM "ACME" THREAD (SPIRAL FLUTE) TAPS

ICS USA

SPECIAL PURPOSE

GROUND THREAD

ROUGHING AND FINISHING

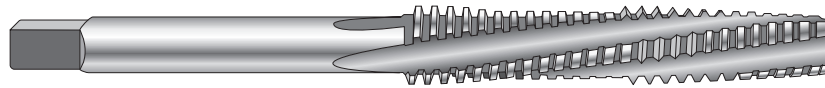

CLASS 2G FIT

High Speed Steel Tandem Acme Thread Spiral Flute Taps are designed with a roughing and finishing section to produce threads from a 10° to 30° included angle in a single pass without a leadscrew. The last few threads on the roughing section act as a guide for the finishing section, which corrects the thread angles and size. Spiral Fluted Tandem Acme Thread Taps have continuous spiral flutes to lift and discharge chips in deep holes. They have black steam oxidized flutes to improve finish and produce a class 2G thread fit.

Right Hand Thread Sizes (1/2" to 2" Dia.)

THREAD SIZE	THREAD LENGTH	OVERALL LENGTH	ITEM NO.
1/2 - 10	2-9/16	5	TATS032-10
5/8 - 8	3-3/16	6-1/4	TATS040-08
3/4 - 6	4-5/16	7-15/16	TATS048-06
3/4 - 8	4-5/16	7-15/16	TATS048-08
7/8 - 6	4-3/8	8-5/8	TATS056-06
1 - 5	5-1/4	10-1/8	TATS100-05

THREAD SIZE	THREAD LENGTH	OVERALL LENGTH	ITEM NO.
1-1/8 - 5	5-1/4	10-3/4	TATS108-05
1-1/4 - 5	5-1/4	11-1/8	TATS116-05
1-3/8 - 4	5-7/8	12-1/4	TATS124-04
1-1/2 - 4	5-7/8	12-5/8	TATS132-04
2 - 4	6-1/2	14-7/8	TATS200-04
2 - 4	6-1/2	14-7/8	TAT200-04

CALL FOR PRICE

Left Hand Thread Sizes (1/2" To 2" Dia.)

THREAD SIZE	THREAD LENGTH	OVERALL LENGTH	ITEM NO.
1/2 - 10	2-9/16	5	TATSL032-10
5/8 - 8	3-3/16	6-1/4	TATSL040-08
3/4 - 6	4-5/16	7-15/16	TATSL048-06
3/4 - 8	4-5/16	7-15/16	TATSL048-08
7/8 - 6	4-3/8	8-5/8	TATSL056-06
1 - 5	5-1/4	10-1/8	TATSL100-05

THREAD SIZE	THREAD LENGTH	OVERALL LENGTH	ITEM NO.
1-1/8 - 5	5-1/4	10-3/4	TATSL108-05
1-1/4 - 5	5-1/4	11-1/8	TATSL116-05
1-3/8 - 4	5-7/8	12-1/4	TATSL124-04
1-1/2 - 4	5-7/8	12-5/8	TATSL132-04
2 - 4	6-1/2	14-7/8	TATSL200-04

CALL FOR PRICE

- Special Acme Taps and other translating thread taps can be made to your requirements. Consult factory for price and and delivery.
- Acme Hexagon Rethreading Dies are also available.

TANDEM "ACME" TAP DRILL SIZES AND MAXIMUM DEPTH OF NUT

ACME TAP THREAD SIZE	ACME TAP DRILL SIZE	MAX. DEPTH OF NUT	
		BRONZE AND STEEL	BRASS AND CAST IRON
1/4 - 16	#10	1	1-1/2
5/16 - 18	17/64	1	1-1/2
3/8 - 12	N	1	1-1/2
7/16 - 12	U	1	1-1/2
1/2 - 10	Z	1	1-1/2
5/8 - 8	13.00MM	1-1/4	1-7/8
3/4 - 6	39/64	1-1/2	2-1/4
3/4 - 8	41/64	1-1/2	2-1/4

ACME TAP THREAD SIZE	ACME TAP DRILL SIZE	MAX. DEPTH OF NUT	
		BRONZE AND STEEL	BRASS AND CAST IRON
7/8 - 6	47/64	1-3/4	2-5/8
1 - 5	49/64	2	3
1-1/8 - 5	24.00MM	2-1/4	3-5/8
1-1/4 - 5	1-1/64	2-1/2	3-3/4
1-3/8 - 5	1-3/32	2-3/4	4-1/8
1-1/2 - 5	32.50MM	3	4-1/2
2 - 4	45.00MM	3	4-1/2

HIGH SPEED STEEL NPT & NPTF TAPER PIPE TAPS

ICS **WIS**

GENERAL PURPOSE

GROUND THREAD

Taper Thread

**MEDIUM
HOOK**

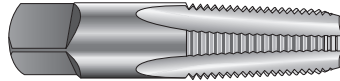

**RIGHT HAND
CUT**

NPT (Regular) Ground • NPTF (Dryseal) Ground

High Speed Steel Taper Pipe Taps (NPT) are designed for tapping ferrous and non-ferrous fittings used to connect pipes carrying fluids or gases and other places where very tight fits are needed. NPT threads taper 3/4" per foot and all of the threads on this tap do the cutting as compared to a (NPS) straight pipe tap where only the non-chamfered threads do the cutting. They require a sealant such as Teflon tape or pipe joint compound to prevent leakage of fluids or gases. NPT pipe taps can be used to tap threads to military aeronautical thread specifications (ANPT) and for work requiring ground thread accuracy and performance. (NPTF) Taper Thread Pipe Taps do not require sealants. Dryseal is attained by metal to metal contact.

NOMINAL SIZE	THREADS PER INCH	NO. OF FLUTES	LENGTH OF THREADS	OVERALL LENGTH	HIGH SPEED STEEL		TiN COATED		PIPE TAP DRILL SIZES
					TAPER REGULAR	TAPER REGULAR (DRYSEAL)	TAPER REGULAR	TAPER REGULAR (DRYSEAL)	
					NPT	NPTF	NPTT	NPTFT	
1/16	27	4	11/16	2-1/8	18.66	18.66	33.26	33.26	"C"
*1/8	27	4	3/4	2-1/8	18.66	18.66	33.26	33.26	"Q"
1/4	18	4	1-1/16	2-7/16	20.62	20.62	36.78	36.78	7/16
3/8	18	4	1-1/16	2-9/16	29.48	26.80	45.76	45.76	9/16
1/2	14	4	1-3/8	3-1/8	47.36	43.06	62.02	62.02	45/64
3/4	14	5	1-3/8	3-1/4	66.74	66.74	94.98	94.98	29/32
1	11-1/2	5	1-3/4	3-3/4	101.26	101.26	158.08	158.08	1-9/64
1-1/4	11-1/2	5	1-3/4	4	144.10	144.10	270.28	270.28	1-31/64
1-1/2	11-1/2	7	1-3/4	4-1/4	193.40	193.40	319.58	319.58	1-23/32
2	11-1/2	7	1-3/4	4-1/2	263.36	263.36	381.28	381.28	2-3/16
2-1/2	8	8	2-9/16	5-1/2	559.58	559.58	-	-	2-39/64
3	8	8	2-5/8	6	785.22	785.22	-	-	3-15/64
3-1/2	8	8	2-11/16	6-1/2	825.16	-	-	-	3-3/4
4	8	8	2-3/4	6-3/4	1120.48	-	-	-	4-1/4

* Available in large [.4375] or small [.3125] diameter shank. If not specified, large will be shipped.

NPT & NPTF Interrupted Thread Pipe Taps

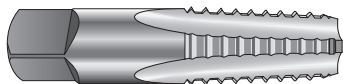

NPT (Regular) Ground • NPTF (Dryseal) Ground

**MEDIUM
HOOK**

NPS, NPSM & NPSC Straight Thread Pipe Taps

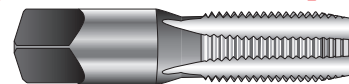

NPS (Regular) Ground • NPSF (Dryseal) Ground

High Speed Steel Interrupted Thread Pipe Taps (NPTI) are designed for tapping soft or tough stringy metals that tend to load threads with chips. Interrupted Thread Pipe Taps start with a few full threads and then have every other thread removed along the thread helix to provide more chip space, better lubrication, and to reduce drag. (NPTIF) Dryseal Interrupted Thread Pipe Taps do not require a sealant. Dryseal is attained by metal to metal contact. The interrupted thread design prevents tearing of material as tap threads only cut one side at a time.

High Speed Steel Straight Thread Pipe Taps (NPS) are designed for tapping holes or couplings for low pressure work that will adjust at assembly to the taper of external threads. A sealant must be used to secure a pressure tight joint. They may be used to produce NPSC and NPSM threads. (NPSF) Straight Thread Pipe Dryseal Taps do not require a sealant. Dryseal is attained by metal to metal contact. They are primarily used to tap holes that connect oil and fuel lines.

NOMINAL SIZE	THREADS PER INCH	NO. OF FLUTES	HIGH SPEED STEEL	
			TAPER INTERRUPTED	TAPER INTERRUPTED (DRYSEAL)
			NPTI	NPTIF
1/16	27	4	25.54	25.54
*1/8	27	4	25.54	25.54
1/4	18	4	28.12	28.12
3/8	18	4	35.78	35.78
1/2	14	4	56.94	56.94
3/4	14	5	89.64	89.64
1	11-1/2	5	137.36	137.36
1-1/4	11-1/2	5	193.12	193.12
1-1/2	11-1/2	7	259.42	259.42
2	11-1/2	7	351.58	351.58

NOMINAL SIZE	THREADS PER INCH	NO. OF FLUTES	HIGH SPEED STEEL	
			STRAIGHT	STRAIGHT (DRYSEAL)
			NPS	NPSF
1/16	27	4	18.86	26.14
*1/8	27	4	18.86	26.14
1/4	18	4	22.00	29.20
3/8	18	4	27.40	38.18
1/2	14	4	49.66	60.88
3/4	14	5	69.92	85.36
1	11-1/2	5	110.32	129.78
1-1/4	11-1/2	5	159.10	177.98
1-1/2	11-1/2	7	283.88	283.88
2	11-1/2	7	387.28	387.28

NOTE: All drilled holes should be reamed before tapping with a pipe reamer having a taper of 3/4" inch per foot – see Pipe Reamers page in Reaming Tools Catalog for correct size.

HIGH SPEED STEEL NPT & NPTF TAPER PIPE TAPS

ICS WIS

GENERAL PURPOSE

GROUND THREAD

Left Hand Thread

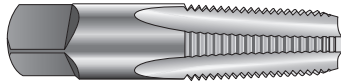

NPT (L.H. Regular) Ground

**MEDIUM
HOOK**

Long Taper Thread



NPT (Regular) Ground

NOMINAL SIZE	THREADS PER INCH	NO. OF FLUTES	HSS	PIPE TAP DRILL SIZES
			TAPER REGULAR (LEFT HAND) NPTLH	
1/16	27	4	30.32	"C"
*1/8	27	4	30.32	"Q"
1/4	18	4	35.34	7/16
3/8	18	4	45.54	9/16
1/2	14	4	65.82	45/64
3/4	14	5	101.32	29/32
1	11-1/2	5	172.08	1-9/64
1-1/4	11-1/2	5	283.10	1-31/64
1-1/2	11-1/2	7	344.64	1-23/32
2	11-1/2	7	557.62	2-3/16

NOMINAL SIZE	THREADS PER INCH	NO. OF FLUTES	HIGH SPEED STEEL	
			6" LENGTH NPT-06L	12" LENGTH NPT-12L
1/16	27	4	32.66	-
*1/8	27	4	32.66	-
1/4	18	4	36.90	57.82
3/8	18	4	49.30	74.58
1/2	14	4	63.50	108.46
3/4	14	5	100.62	136.90
1	11-1/2	5	128.70	185.82

HIGH SPEED STEEL BRITISH (METRIC) STANDARD PIPE TAPS

ICS USA

GENERAL PURPOSE

GROUND THREAD

British (Taper) Standard (Rc)

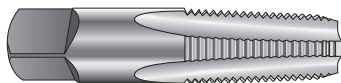

BSPT (Regular) Ground

**MEDIUM
HOOK**

British (Parallel) Standard (G or Rp)



BSPP (Regular) Ground

High Speed Steel British Standard Pipe Taper Taps (BSPT) are the European equivalent of American Standard Taper Pipe Taps (NPT) and are sometimes referred to as Metric Taper Pipe Taps. They are designed for tapping ferrous and non-ferrous pipe fittings used to connect pipes carrying fluids or gases. They require a sealant such as Teflon tape or pipe joint compound to prevent leakage of fluids or gases. (BSPT) taps are used for work requiring ground thread accuracy and performance.

High Speed Steel British Standard Pipe Parallel Taps (BSPP) are the European equivalent of American Standard Straight Pipe Taps (NPS) and are sometimes referred to as Metric Straight or Parallel Pipe Taps. They are designed for tapping holes or couplings for low pressure work that will adjust at assembly to the taper of external threads. A sealant must be used to secure a pressure-tight joint.

NOMINAL SIZE	THREADS PER INCH	NO. OF FLUTES	HSS	PIPE TAP DRILL SIZES
			BRITISH STANDARD (TAPER) BSPT	
1/8	28	4	16.78	5/16
1/4	19	4	18.00	27/64
3/8	19	4	25.20	9/16
1/2	14	4	36.76	11/16
5/8	14	4	105.00	25/32
3/4	14	4	50.82	29/32
7/8	14	4	74.56	1-1/16
1	11	6	78.44	1-1/8
1-1/4	11	6	113.92	1-15/32
1-1/2	11	6	151.72	1-25/32
2	11	6	212.20	2-5/32

NOMINAL SIZE	THREADS PER INCH	NO. OF FLUTES	HSS	PIPE TAP DRILL SIZES
			BRITISH STANDARD (PARALLEL) BSPP	
1/8	28	4	16.78	"S"
1/4	19	4	18.00	15/32
3/8	19	4	25.20	19/32
1/2	14	4	36.76	3/4
5/8	14	4	46.20	53/64
3/4	14	4	50.82	31/32
7/8	14	4	74.56	1-7/64
1	11	6	78.44	1-7/32
1-1/4	11	6	113.92	1-9/16
1-1/2	11	6	151.72	1-25/32
2	11	6	212.20	2-1/4

CARBON STEEL TAPER PIPE TAPS

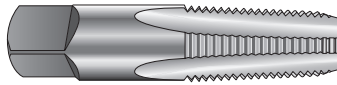
ICS WIS
GENERAL PURPOSE
CUT THREAD

**MEDIUM
HOOK**

Carbon Steel Taper Pipe Taps (NPT) are designed for tapping ferrous and non-ferrous pipe fittings used to connect pipes carrying fluids or gases. They are primarily used for maintenance work where ground thread accuracy and performance are not required. A sealant such as Teflon tape or pipe joint compound is necessary to prevent leakage of fluids or gases. All NPT Pipe Taps are furnished with a 2-1/2 to 5-1/2 thread chamfer.

NOMINAL SIZE	THREADS PER INCH	NO. OF FLUTES	FLUTE LENGTH	OVERALL LENGTH	ITEM NO.	PRICE	PIPE TAP DRILL SIZES
1/16	27	4	11/16	2-1/8	CNPT004-27	4.36	"C"
1/8	27	4	3/4	2-1/8	CNPT008-27	4.36	"Q"
1/4	18	4	1-1/16	2-7/16	CNPT016-18	5.92	7/16
3/8	18	4	1-1/16	2-9/16	CNPT024-18	8.32	9/16
1/2	14	4	1-3/8	3-1/8	CNPT032-14	20.72	45/64
3/4	14	5	1-3/8	3-1/4	CNPT048-14	32.20	29/32
1	11-1/2	5	1-3/4	3-3/4	CNPT100-11.5	42.02	1-9/64
1-1/4	11-1/2	5	1-3/4	4	CNPT116-11.5	53.18	1-31/64
1-1/2	11-1/2	7	1-3/4	4-1/4	CNPT132-11.5	71.72	1-23/32
2	11-1/2	7	1-3/4	4-1/4	CNPT200-11.5	117.70	2-3/16
2-1/2	8	8	2-9/16	5-1/2	CNPT232-08	300.00	2-39/64
3	8	8	2-5/8	6	CNPT300-08	380.00	3-15/64
3-1/2	8	8	2-11/16	6-1/2	CNPT332-08	424.08	3-21/32
4	8	10	2-3/4	6-3/4	CNPT400-08	702.00	4-15/64
5	8	10	3	7-1/2	CNPT500-08	972.22	5-19/64
6	8	10	3-5/8	8-1/2	CNPT600-08	1438.54	6-11/32

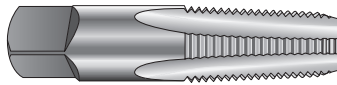
CARBON STEEL BRITISH STANDARD (TAPER) PIPE TAPS

ICS WIS
GENERAL PURPOSE
CUT THREAD

**MEDIUM
HOOK**

Carbon Steel British Standard Taper Pipe Taps (BSPT) are the European equivalent of Carbon Steel American Taper Pipe Taps (NPT) and are sometimes referred to as Metric Taper Pipe Taps. They are designed for tapping ferrous and non-ferrous pipe fittings used to connect pipes carrying fluids or gases. They are primarily used for maintenance work where ground thread accuracy and performance are not required. A sealant such as Teflon tape or pipe joint compound is necessary to prevent leakage of fluids or gases. All BSPT pipe threads are tapered 3/4" per foot because tapered threads permit tighter connections than are possible with straight threads.

NOMINAL SIZE	THREADS PER INCH	NO. OF FLUTES	FLUTE LENGTH	OVERALL LENGTH	ITEM NO.	PRICE	PIPE TAP DRILL SIZES
1/8	28	4	3/4	2-1/8	CBSPT008-28	5.26	5/16
1/4	19	4	1-1/16	2-7/16	CBSPT016-19	6.74	27/64
3/8	19	4	1-1/16	2-9/16	CBSPT024-19	8.32	9/16
1/2	14	4	1-3/8	3-1/8	CBSPT032-14	20.72	11/16
5/8	14	4	1-3/8	3-3/16	CBSPT040-14	24.70	25/32
3/4	14	4	1-3/8	3-1/4	CBSPT048-14	32.20	29/32
7/8	14	4	1-9/16	3-1/2	CBSPT056-14	34.10	1-1/16
1	11	6	1-3/4	3-3/4	CBSPT100-11	42.02	1-1/8
1-1/4	11	6	1-3/4	4	CBSPT116-11	53.18	1-15/32
1-1/2	11	6	1-3/4	4-1/4	CBSPT132-11	71.72	1-25/32
2	11	6	1-3/4	4-1/2	CBSPT200-11	117.70	2-5/32

TAP EXTENSIONS

ICS WIS

SPECIAL PURPOSE



FOR HAND TAPPING ONLY

Tap Extensions are added to the end of a tap to reach into deep narrow locations or in close quarters where it is difficult to turn a tap wrench. More economical than buying special length hand and pipe taps.

FOR TAPS			SQUARE	ITEM		ITEM	PRICE
FRACTIONAL	METRIC	PIPE	TAP SHANK	FRACTIONAL	METRIC	NO.	
#6 (1/8)	M3	-	.118	3-9/64	80mm	TX#06	3.68
#8 (5/32)	M4	-	.134	3-3/4	95mm	TX#08	4.10
#10	M4,M5	-	.150	3-63/64	100mm	TX#10	4.52
#12 (3/16)	-	1/8	.169	4-1/8	105mm	TX#12	4.72
7/32 - 5/16	M5 - M8	-	.193	4-21/64	110mm	TX016	5.36
3/8	M9 - M10	-	.216	4-17/32	115mm	TX024	6.10
7/16	M11	-	.244	4-37/64	120mm	TX028	6.62
1/2	M12	-	.276	4-59/64	125mm	TX032	7.46
9/16 - 5/8	M13 - M16	1/4 - 3/8	.354	5-5/16	135mm	TX040	8.82
11/16 - 3/4	M18	-	.433	5-29/32	150mm	TX048	10.08
7/8 - 15/16	M22 - M26	-	.570	6-57/64	175mm	TX056	14.28
1"	M27 - M28	3/4	.630	7-9/32	185mm	TX100	16.80

CUSTOM SIZE TAP EXTENSIONS

ICS USA

SPECIAL PURPOSE

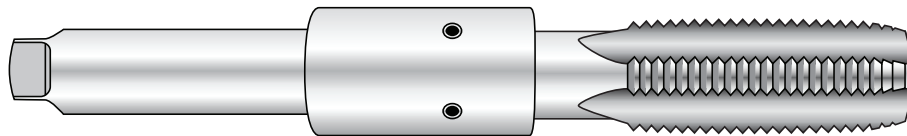

ILLUSTRATION OF 1-3/8 - 6 TAP WITH CUSTOM TAP EXTENSION

Custom Size Tap Extensions for taps over 1" can be manufactured for specific lengths. Inquire for pricing.

QUOTE INFORMATION

QTY _____ TAP SIZE _____ EXTENSION LENGTH REQUIRED _____

OTHER REQUIREMENTS _____

CARBON STEEL - HIGH SPEED STEEL TAPER PIPE TAP SETS

GENERAL PURPOSE

6 Piece High Speed and Carbon Steel American National Standard Pipe Thread Tap Sets are available in NPT, NPTF, NPS, NPSF, NPT-Interrupted, and NPT-Left hand thread forms. They are made to ANSI B1.20.1-1983 tap dimensions.

ILLUSTRATION	DESCRIPTION	STEEL SPEC	CUT	THREAD FORM	ITEM NO.	PRICE
 <p style="margin-top: 10px;">6 PC PIPE TAP SETS</p> <p style="margin-top: 10px;">Sizes 1/8" to 1"</p>	6 PC Pipe Tap Set available in hinged wooden case or industrial plastic case. Contents of set is listed below.	CS	Right Hand	Taper	TS-CNPT-6	151.06
		HSS	Right Hand	Taper	TS-NPT-6	292.56
		HSS	Right Hand	Interrupted	TS-NPTI-6	381.02
		HSS	Right Hand	Straight	TS-NPS-6	311.90
		HSS	Left Hand	Reg. Taper	TS-NPTL-6	488.02
		SIZES OF PIPE TAPS IN SET				
American – 1/8-27, 1/4-18, 3/8-18, 1/2-14, 3/4-14, 1-11-1/2						

CARBON STEEL - HIGH SPEED STEEL BRITISH STANDARD PIPE TAP SETS

GENERAL PURPOSE

6 Piece High Speed and Carbon Steel British Standard Pipe Thread Tap Sets are available in BSPT and BSPF thread forms. They are made to BS2779-ISO529 tap dimensions.

ILLUSTRATION	DESCRIPTION	STEEL SPEC	CUT	THREAD FORM	ITEM NO.	PRICE
 <p style="margin-top: 10px;">6 PC PIPE TAP SETS</p> <p style="margin-top: 10px;">Sizes 1/8" to 1"</p>	6 PC Pipe Tap Set available in hinged wooden case or industrial plastic case. Contents of set is listed below.	CS	Right Hand	Reg. Taper	TS-CBSPT-6	162.12
		HSS	Right Hand	Reg. Taper	TS-BSPT-6	553.76
		HSS	Right Hand	Parallel	TS-BSPP-6	553.76
		SIZES OF PIPE TAPS IN SET				
British – 1/8-28, 1/4-19, 3/8-19, 1/2-14, 3/4-14, 1-11						

HIGH SPEED STEEL ROUND ADJUSTABLE DIES

ICS WIS

GENERAL PURPOSE

GROUND THREAD

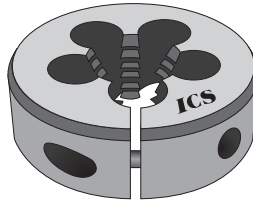

**SCREW ADJUSTING
TYPE**

**RIGHT HAND
CUT**

BLACK & GOLD OXIDE FINISH

Round Adjustable Dies are designed for cutting external screw threads, either by hand, using a die stock or by machine, using a floating die holder. They also can be used to cut smaller or larger than factory setting by turning the adjusting screw in or out. Dies are manufactured with a 2-3 thread chamfer on front face and a 1-1/2 thread chamfer on the rear. Round Adjustable Dies are also known as Button Dies.

Machine Screw and Fractional Sizes (#0 to 2-1/2" Dia.)

SIZE	TPI	ITEM NO.	PRICE
13/16" ROUND DIE			
#0	80	RAD#00-80X052	20.58
#1	64	RAD#01-64X052	20.58
#1	72	RAD#01-72X052	20.58
#2	56	RAD#02-56X052	17.38
#2	64	RAD#02-64X052	17.38
#3	48	RAD#03-48X052	17.38
#3	56	RAD#03-56X052	17.38
#4	36	RAD#04-36X052	17.38
#4	40	RAD#04-40X052	17.38
#5	40	RAD#05-40X052	17.38
#5	44	RAD#05-44X052	17.38
#6	32	RAD#06-32X052	17.38
#6	40	RAD#06-40X052	17.38
#8	32	RAD#08-32X052	17.38
#8	36	RAD#08-36X052	17.38
#10	24	RAD#10-24X052	17.38
#10	32	RAD#10-32X052	17.38
#12	24	RAD#12-24X052	17.38
#12	28	RAD#12-28X052	17.38
1/4	20	RAD016-20X052	17.38
1/4	28	RAD016-28X052	17.38
5/16	18	RAD020-18X052	17.38
5/16	24	RAD020-24X052	17.38
1" ROUND DIE			
#0	80	RAD#00-80X100	22.12
#1	64	RAD#01-64X100	22.12
#1	72	RAD#01-72X100	22.12
#2	56	RAD#02-56X100	22.12
#2	64	RAD#02-64X100	22.12
#3	48	RAD#03-48X100	22.12
#3	56	RAD#03-56X100	22.12
#4	36	RAD#04-36X100	22.12
#4	40	RAD#04-40X100	22.12
#5	40	RAD#05-40X100	22.12
#5	44	RAD#05-44X100	22.12
#6	32	RAD#06-32X100	22.12
#6	40	RAD#06-40X100	22.12
#8	32	RAD#08-32X100	22.12
#8	36	RAD#08-36X100	22.12
#10	24	RAD#10-24X100	22.12
#10	32	RAD#10-32X100	22.12
#12	24	RAD#12-24X100	22.12
#12	28	RAD#12-28X100	22.12
1/4	20	RAD016-20X100	22.12
1/4	28	RAD016-28X100	22.12

SIZE	TPI	ITEM NO.	PRICE
1" ROUND DIE			
5/16	18	RAD020-18X100	22.12
5/16	24	RAD020-24X100	22.12
3/8	16	RAD024-16X100	22.12
3/8	24	RAD024-24X100	22.12
7/16	14	RAD028-14X100	22.12
7/16	20	RAD028-20X100	22.12
1/2	13	RAD032-13X100	22.12
1/2	20	RAD032-20X100	22.12
1-1/2" ROUND DIE			
1/4	20	RAD016-20X132	34.70
1/4	28	RAD016-28X132	34.70
5/16	18	RAD020-18X132	34.70
5/16	24	RAD020-24X132	34.70
3/8	16	RAD024-16X132	34.70
3/8	24	RAD024-24X132	34.70
7/16	14	RAD028-14X132	34.70
7/16	20	RAD028-20X132	34.70
1/2	13	RAD032-13X132	34.70
1/2	20	RAD032-20X132	34.70
9/16	12	RAD036-12X132	34.70
9/16	18	RAD036-18X132	34.70
5/8	11	RAD040-11X132	34.70
5/8	18	RAD040-18X132	34.70
11/16	11	RAD044-11X132	34.70
11/16	16	RAD044-16X132	34.70
3/4	10	RAD048-10X132	34.70
3/4	16	RAD048-16X132	34.70
2" ROUND DIE			
1/4	20	RAD016-20X200	61.28
1/4	28	RAD016-28X200	61.28
5/16	18	RAD020-18X200	61.28
5/16	24	RAD020-24X200	61.28
3/8	16	RAD024-16X200	61.28
3/8	24	RAD024-24X200	61.28
7/16	14	RAD028-14X200	61.28
7/16	20	RAD028-20X200	61.28
1/2	13	RAD032-13X200	61.28
1/2	20	RAD032-20X200	61.28
9/16	12	RAD036-12X200	61.28
9/16	18	RAD036-18X200	61.28
5/8	11	RAD040-11X200	61.28
5/8	18	RAD040-18X200	61.28
11/16	11	RAD044-11X200	61.28
11/16	16	RAD044-16X200	61.28

SIZE	TPI	ITEM NO.	PRICE
2" ROUND DIE			
3/4	10	RAD048-10X200	61.28
3/4	16	RAD048-16X200	61.28
7/8	9	RAD056-09X200	61.28
7/8	14	RAD056-14X200	61.28
1	8	RAD100-08X200	61.28
1	12	RAD100-12X200	61.28
1	14	RAD100-14X200	61.28
2-1/2" ROUND DIE			
1	8	RAD100-08X232	105.52
1	12	RAD100-12X232	105.52
1	14	RAD100-14X232	105.52
1-1/8	7	RAD108-07X232	105.52
1-1/8	12	RAD108-12X232	105.52
1-1/4	7	RAD116-07X232	105.52
1-1/4	12	RAD116-12X232	105.52
1-3/8	6	RAD124-06X232	105.52
1-3/8	12	RAD124-12X232	105.52
1-1/2	6	RAD132-06X232	105.52
1-1/2	12	RAD132-12X232	105.52
3" ROUND DIE			
1	8	RAD100-08X300	200.02
1	12	RAD100-12X300	200.02
1	14	RAD100-14X300	200.02
1-1/8	7	RAD108-07X300	200.02
1-1/8	12	RAD108-12X300	200.02
1-1/4	7	RAD116-07X300	200.02
1-1/4	12	RAD116-12X300	200.02
1-3/8	6	RAD124-06X300	200.02
1-3/8	12	RAD124-12X300	200.02
1-1/2	6	RAD132-06X300	200.02
1-1/2	12	RAD132-12X300	200.02
1-3/4	5-1/2	RAD148-5.5X300	200.02
1-3/4	12	RAD148-12X300	200.02
2	4-1/2	RAD200-04X300	200.02
2	12	RAD200-12X300	200.02
4" ROUND DIE			
2-1/4	4-1/2	RAD216-4.5X400	282.24
2-1/4	12	RAD216-12X400	282.24
2-1/2	4	RAD232-04X400	282.24
2-1/2	12	RAD232-12X400	282.24

NOTE: Larger Right Hand Dies are available upon request.

Die Stocks, Holders, and Adapters are on page 80.

LEFT HAND ROUND ADJUSTABLE DIES

ICS WIS

SPECIAL PURPOSE

GROUND THREAD

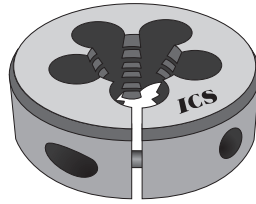

SCREW ADJUSTING TYPE

LEFT HAND CUT

BLACK & GOLD OXIDE FINISH

Machine Screw and Fractional Sizes (#0 to 2" Dia.)

SIZE	TPI	ITEM NO.	PRICE
1 3/16" ROUND DIE			
#0	80	RADL#00-80	25.88
#2	56	RADL#02-56	25.88
#2	64	RADL#02-64	25.88
1" ROUND DIE			
#4	36	RADL#04-36	30.04
#4	40	RADL#04-40	30.04
#5	40	RADL#05-40	30.04
#5	44	RADL#05-44	30.04
#6	32	RADL#06-32	30.04
#6	40	RADL#06-40	30.04
#8	32	RADL#08-32	30.04
#8	36	RADL#08-36	30.04
#10	24	RADL#10-24	30.04
#10	32	RADL#10-32	30.04
#12	24	RADL#12-24	30.04
#12	28	RADL#12-28	30.04
1/4	20	RADL016-20	30.04
1/4	28	RADL016-28	30.04
5/16	18	RADL020-18	30.04
5/16	24	RADL020-24	30.04
3/8	16	RADL024-16	30.04
3/8	24	RADL024-24	30.04
7/16	14	RADL028-14	30.04
7/16	20	RADL028-20	30.04
1/2	13	RADL032-13*	30.04
1/2	20	RADL032-20X100	30.04

SIZE	TPI	ITEM NO.	PRICE
1-1/2" ROUND DIE			
1/4	20	RADL016-20*	44.74
1/4	28	RADL016-28*	44.74
5/16	18	RADL020-18*	44.74
5/16	24	RADL020-24*	44.74
3/8	16	RADL024-16*	44.74
3/8	24	RADL024-24*	44.74
7/16	14	RADL028-14*	44.74
7/16	20	RADL028-20*	44.74
1/2	13	RADL032-13	44.74
1/2	20	RADL032-20	44.74
9/16	12	RADL036-12	44.74
9/16	18	RADL036-18	44.74
5/8	11	RADL040-11	44.74
5/8	18	RADL040-18	44.74
11/16	11	RADL044-11	44.74
11/16	16	RADL044-16	44.74
3/4	10	RADL048-10	44.74
3/4	16	RADL048-16	44.74
7/8	9	RADL056-09	44.74
7/8	14	RADL056-14	44.74

SIZE	TPI	ITEM NO.	PRICE
2" ROUND DIE			
3/4	10	RADL048-10*	82.00
3/4	16	RADL048-16*	82.00
7/8	9	RADL056-09	82.00
7/8	14	RADL056-14	82.00
1	8	RADL100-08	82.00
1	12	RADL100-12	82.00
1	14	RADL100-14	82.00
2-1/2" ROUND DIE			
1-1/8	7	RADL108-07	105.52
1-1/8	12	RADL108-12	105.52
1-1/4	7	RADL116-07	105.52
1-1/4	12	RADL116-12	105.52
1-3/8	6	RADL124-06	105.52
1-3/8	12	RADL124-12	105.52
1-1/2	6	RADL132-06	105.52
1-1/2	12	RADL132-12	105.52
3" ROUND DIE			
1-3/4	5	RADL148-05	210.32
2	4-1/2	RADL200-04.5	210.32

NOTE:

Larger Left Hand Dies and Special Thread Dies are available. Consult factory for pricing.

Metric Sizes (2.0mm to 20.0mm Dia.)

SIZE	PITCH	ITEM NO.	PRICE
1" ROUND DIE			
M2.0	M0.4	RADML02.0X0.40	32.34
M2.5	M0.45	RADML02.5X0.45	32.34
M3.0	M0.5	RADML03.0X0.50	32.34
M3.5	M0.6	RADML03.5X0.60	32.34
M4.0	M0.7	RADML04.0X0.70	32.34
M4.0	M0.75	RADML04.0X0.75	32.34
M5.0	M0.8	RADML05.0X0.80	32.34
M6.0	M0.75	RADML06.0X0.75	32.34
M6.0	M1.0	RADML06.0X1.00	32.34

SIZE	PITCH	ITEM NO.	PRICE
1" ROUND DIE			
M7.0	M0.75	RADML07.0X0.75	32.34
M7.0	M1.0	RADML07.0X1.00	32.34
M8.0	M1.0	RADML08.0X1.00	32.34
M8.0	M1.25	RADML08.0X1.25	32.34
M10	M1.0	RADML10.0X1.00	32.34
M10	M1.25	RADML10.0X1.25	32.34
M10	M1.5	RADML10.0X1.50	32.34
M12	M1.0	RADML12.0X1.00	32.34
M14	M0.75	RADML14.0X0.75	32.34

SIZE	PITCH	ITEM NO.	PRICE
1-1/2" ROUND DIE			
M14	M1.0	RADML14.0X1.0	44.74
M14	M1.5	RADML14.0X1.50	44.74
M14	M2.0	RADML14.0X2.0	44.74
M16	M1.5	RADML16.0X1.5	44.74
M16	M2.0	RADML16.0X2.0	44.74
M18	M1.5	RADML18.0X1.50	44.74
M18	M2.5	RADML18.0X2.5	44.74
M20	M1.5	RADML20.0X1.50	44.74
M20	M2.5	RADML20.0X2.50	44.74

HIGH SPEED STEEL ROUND ADJUSTABLE (METRIC) DIES

ICS **WIS**

GENERAL PURPOSE

GROUND THREAD

**SCREW ADJUSTING
TYPE**

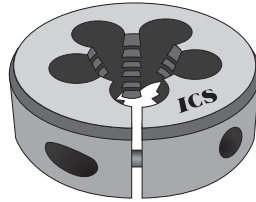

**RIGHT HAND
CUT**

BLACK & GOLD FINISH

Standard Metric Sizes (1.0mm to 52.0mm Dia.)

SIZE	PITCH	ITEM NO.	PRICE
13/16" ROUND DIE			
M1.0	0.25	RADM01.0X0.25	25.88
M1.2	0.25	RADM01.2X0.25	25.88
M1.6	0.35	RADM01.6X0.35	25.88
M1.8	0.35	RADM01.8X0.35	25.88
M2.0	0.40	RADM02.0X0.40	23.52
M2.2	0.45	RADM02.2X0.45	23.52
M2.5	0.45	RADM02.5X0.45	23.52
M3.0	0.35	RADM03.0X0.35	23.52
M3.0	0.50	RADM03.0X0.50*	23.52
M3.5	0.35	RADM03.5X0.35	23.52
M3.5	0.60	RADM03.5X0.60*	23.52
M4.0	0.50	RADM04.0X0.50*	23.52
M4.0	0.70	RADM04.0X0.70*	23.52
M4.5	0.50	RADM04.5X0.50	23.52
M4.5	0.75	RADM04.5X0.75*	23.52
M5.0	0.50	RADM05.0X0.50*	23.52
M5.0	0.80	RADM05.0X0.80*	23.52
M6.0	0.75	RADM06.0X0.75.	23.52
M6.0	1.00	RADM06.0X01.	23.52
1" ROUND DIE			
M1.6	0.35	RADM01.6X0.35*	22.12
M1.8	0.35	RADM01.8X0.35*	22.12
M2.0	0.40	RADM02.0X0.40*	22.12
M2.2	0.45	RADM02.2X0.45*	22.12
M2.5	0.45	RADM02.5X0.45*	22.12
M3.0	0.35	RADM03.0X0.35*	22.12
M3.0	0.50	RADM03.0X0.50	22.12
M3.5	0.35	RADM03.5X0.35*	22.12
M3.5	0.60	RADM03.5X0.60	22.12
M4.0	0.50	RADM04.0X0.50	22.12
M4.0	0.70	RADM04.0X0.70	22.12
M4.5	0.50	RADM04.5X0.50	22.12
M4.5	0.75	RADM04.5X0.75	22.12
M5.0	0.50	RADM05.0X0.50	22.12
M5.0	0.80	RADM05.0X0.80	22.12
M6.0	0.75	RADM06.0X0.75	22.12
M6.0	1.00	RADM06.0X1.0	22.12

SIZE	PITCH	ITEM NO.	PRICE
1" ROUND DIE			
M6.3	1.00	RADM06.3X1.0	22.12
M7.0	0.75	RADM07.0X0.75	22.12
M7.0	1.00	RADM07.0X1.0	22.12
M8.0	1.00	RADM08.0X1.0	22.12
M8.0	1.25	RADM08.0X1.25	22.12
M9.0	1.00	RADM09.0X1.0	22.12
M9.0	1.25	RADM09.0X1.25	22.12
M10.0	1.25	RADM10.0X1.25	22.12
M10.0	1.50	RADM10.0X1.5	22.12
M11.0	1.25	RADM11.0X1.25	22.12
M11.0	1.50	RADM11.0X1.5	22.12
M12.0	1.25	RADM12.0X1.25	22.12
M12.0	1.75	RADM12.0X1.75	22.12
1-1/2" ROUND DIE			
M6.0	0.75	RADM06.0X0.75*	34.70
M6.0	1.00	RADM06.0X1.0*	34.70
M7.0	0.75	RADM07.0X0.75*	34.70
M7.0	1.00	RADM07.0X1.0*	34.70
M8.0	1.00	RADM08.0X1.0*	34.70
M8.0	1.25	RADM08.0X1.25*	34.70
M9.0	1.00	RADM09.0X1.0*	34.70
M9.0	1.25	RADM09.0X1.25*	34.70
M10.0	1.25	RADM10.0X1.25*	34.70
M10.0	1.50	RADM10.0X1.5*	34.70
M11.0	1.25	RADM11.0X1.25*	34.70
M11.0	1.50	RADM11.0X1.5*	34.70
M12.0	1.25	RADM12.0X1.25*	34.70
M12.0	1.75	RADM12.0X1.75*	34.70
M14.0	1.50	RADM14.0X1.5	41.16
M14.0	2.00	RADM14.0X2.0	41.16
M16.0	1.50	RADM16.0X1.5	34.70
M16.0	2.00	RADM16.0X2.0	34.70
M18.0	1.50	RADM18.0X1.5	41.16
M18.0	2.50	RADM18.0X2.5	34.70
M20.0	1.50	RADM20.0X1.5	34.70
M20.0	2.50	RADM20.0X2.5	34.70

SIZE	PITCH	ITEM NO.	PRICE
2" ROUND DIE			
M16.0	1.50	RADM16.0X1.5*	61.74
M16.0	2.00	RADM16.0X2.0*	61.74
M18.0	1.50	RADM18.0X1.5*	61.74
M18.0	2.50	RADM18.0X2.5*	61.74
M20.0	1.50	RADM20.0X1.5*	61.74
M20.0	2.50	RADM20.0X2.5*	61.74
M22.0	1.50	RADM22.0X1.5	61.74
M22.0	2.50	RADM22.0X2.5	61.74
M24.0	2.00	RADM24.0X2.0	61.74
M24.0	3.00	RADM24.0X3.0	61.74
M27.0	2.00	RADM27.0X2.0	61.74
M27.0	3.00	RADM27.0X3.0	61.74
M30.0	2.00	RADM30.0X2.0	61.74
M30.0	3.50	RADM30.0X3.5	61.74
2-1/2" ROUND DIE			
M24.0	2.00	RADM24.0X2.0*	105.52
M24.0	3.00	RADM24.0X3.0*	105.52
M27.0	2.00	RADM27.0X2.0*	105.52
M27.0	3.00	RADM27.0X3.0*	105.52
M30.0	2.00	RADM30.0X2.0*	105.52
M30.0	3.50	RADM30.0X3.5*	105.52
M33.0	2.00	RADM33.0X2.0	105.52
M33.0	3.50	RADM33.0X3.5	105.52
M36.0	3.00	RADM36.0X3.00	105.52
M36.0	4.00	RADM36.0X4.0	105.52
3" ROUND DIE			
M36.0	3.00	RADM36.0X3.0*	200.02
M36.0	4.00	RADM36.0X4.0*	200.02
M39.0	3.00	RADM39.0X3.0	200.02
M39.0	4.00	RADM39.0X4.0	200.02
M42.0	4.50	RADM42.0X4.5	200.02
M45.0	4.50	RADM45.0X4.5	200.02
M48.0	5.00	RADM48.0X5.0	200.02
M52.0	5.00	RADM52.0X5.0	200.02

NOTE: Fine Thread Pitches are shown in **BOLD TYPE**. Asterisks * show they are alternate diameters. If unsure, specify diameter when ordering • Larger Metric Size Dies are available upon request.

Die Stocks, Holders, and Adapters are on page 248.

ROUND ADJUSTABLE (SPECIAL METRIC) DIES

ICS WIS

GENERAL PURPOSE

GROUND THREAD

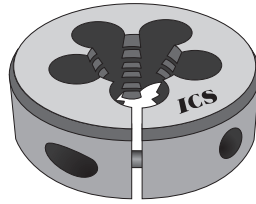

BLACK & GOLD FINISH

SCREW ADJUSTING TYPE

RIGHT HAND CUT

Special Metric Sizes (1.7mm to 52.0mm Dia.)

SIZE	PITCH	ITEM NO.	PRICE
1" ROUND DIE			
M1.7	.20	RADMS01.7X0.20	25.88
M1.7	.35	RADMS01.7X0.35	25.88
M2.0	.25	RADMS02.0X0.25	25.88
M2.3	.40	RADMS02.3X0.40	25.88
M2.5	.50	RADMS02.5X0.50	25.88
M2.6	.35	RADMS02.6X0.35	25.88
M2.6	.45	RADMS02.6X0.45	25.88
M3.0	.60	RADMS03.0X0.60	25.88
M3.0	.75	RADMS03.0X0.75	25.88
M3.5	.50	RADMS03.5X0.50	25.88
M4.0	.35	RADMS04.0X0.35	25.88
M4.0	.60	RADMS04.0X0.60	25.88
M4.0	.75	RADMS04.0X0.75	25.88
M4.0	1.00	RADMS04.0X1.00	25.88
M4.5	1.00	RADMS04.5X1.00	25.88
M5.0	.75	RADMS05.0X.75	25.88
M5.0	.90	RADMS05.0X.90	25.88
M5.0	1.00	RADMS05.0X1.00	25.88
M5.5	.50	RADMS05.5X.70	25.88
M5.5	.70	RADMS05.5X0.50	25.88
M5.5	.90	RADMS05.5X0.90	25.88
M6.0	.50	RADMS06.0X.50	25.88
M6.0	1.25	RADMS06.0X1.25	25.88
M6.0	1.50	RADMS06.0X1.50	25.88
M7.0	.50	RADMS07.0X0.50	25.88
M7.0	1.25	RADMS07.0X1.25	25.88
M8.0	.50	RADMS08.0X0.50	25.88
M8.0	.75	RADMS08.0X0.75	25.88
M8.0	1.50	RADMS08.0X1.50	25.88
M8.0	1.75	RADMS08.0X1.75	25.88
M9.0	.50	RADMS09.0X.50	25.88
M9.0	.75	RADMS09.0X.75	25.88
M9.0	1.50	RADMS09.0X1.50	25.88
M9.0	1.75	RADMS09.0X1.75	25.88
M10	.50	RADMS10.0X.50	25.88
M10	.75	RADMS10.0X.75	25.88
M10	1.00	RADMS10.0X1.0	25.88
M10	1.75	RADMS10.0X1.75	25.88
M10	2.00	RADMS10.0X2.0	25.88
M11	.50	RADMS11.0X.50	25.88
M11	.75	RADMS11.0X.75	25.88
M11	1.00	RADMS11.0X1.0	25.88
M11	1.75	RADMS11.0X1.75	25.88
M11	2.00	RADMS11.0X2.00	25.88
M12	.50	RADMS12.0X.50	25.88
M12	.75	RADMS12.0X.75	25.88
M12	1.00	RADMS12.0X1.0	25.88
M12	1.75	RADMS12.0X1.75	25.88
M12	2.00	RADMS12.0X2.0	25.88
1-1/2" ROUND DIE			
M9.0	.50	RADMS09.0X.50*	41.16
M9.0	.75	RADMS09.0X.75*	41.16
M10	.50	RADMS10.0X.50*	41.16

SIZE	PITCH	ITEM NO.	PRICE
1-1/2" ROUND DIE			
M10	.75	RADMS10.0X.75*	41.16
M10	1.00	RADMS10.0X1.0*	41.16
M11	.50	RADMS11.0X.50*	41.16
M11	.75	RADMS11.0X.75*	41.16
M11	1.00	RADMS11.0X1.0*	41.16
M12	.50	RADMS12.0X.50*	41.16
M12	.75	RADMS12.0X.75*	41.16
M12	1.00	RADMS12.0X1.0*	41.16
M12	1.75	RADMS12.0X1.75*	41.16
M12	2.00	RADMS12.0X2.0*	41.16
M13	.50	RADMS13.0X.50	41.16
M13	.75	RADMS13.0X.75	41.16
M13	1.00	RADMS13.0X1.00	41.16
M13	1.25	RADMS13.0X1.25	41.16
M13	1.50	RADMS13.0X1.50	41.16
M13	1.75	RADMS13.0X1.75	41.16
M13	2.00	RADMS13.0X2.0	41.16
M14	.50	RADMS14.0X.50	41.16
M14	.75	RADMS14.0X.75	41.16
M14	1.00	RADMS14.0X1.0	41.16
M14	1.25	RADMS14.0X1.25	41.16
M14	1.75	RADMS14.0X1.75	41.16
M15	.50	RADMS15.0X.50	41.16
M15	1.00	RADMS15.0X1.00	41.16
M15	1.50	RADMS15.0X1.5	41.16
M15	2.00	RADMS15.0X2.0	41.16
M16	.50	RADMS16.0X.50	41.16
M16	.75	RADMS16.0X.75	41.16
M16	1.00	RADMS16.0X1.0	41.16
M16	1.25	RADMS16.0X1.25	41.16
M16	1.75	RADMS16.0X1.75	41.16
M17	.50	RADMS17.0X.50	41.16
M17	1.00	RADMS17.0X1.00	41.16
M17	1.50	RADMS17.0X1.5	41.16
M17	2.00	RADMS17.0X2.0	41.16
M18	.50	RADMS18.0X.50	41.16
M18	1.00	RADMS18.0X1.0	41.16
M18	1.25	RADMS18.0X1.25	41.16
M18	1.75	RADMS18.0X1.75	41.16
M18	2.00	RADMS18.0X2.0	41.16
M19	.50	RADMS19.0X.50	41.16
M19	1.00	RADMS19.0X1.0	41.16
M19	1.50	RADMS19.0X1.5	41.16
M19	2.00	RADMS19.0X2.0	41.16
M20	1.00	RADMS20.0X1.0	41.16
M20	1.25	RADMS20.0X1.25	41.16
M20	1.75	RADMS20.0X1.75	41.16
M20	2.00	RADMS20.0X2.00	41.16
2" ROUND DIE			
M18	1.00	RADMS18.0X1.0*	72.32
M19	1.50	RADMS19.0X1.5*	72.32
M20	1.00	RADMS20.0X1.0*	72.32
M20	1.25	RADMS20.0X1.25*	72.32

SIZE	PITCH	ITEM NO.	PRICE
2" ROUND DIE			
M20	2.00	RADMS20.0X2.00*	72.32
M21	1.00	RADMS21.0X1.00	72.32
M21	1.50	RADMS21.0X1.5	72.32
M21	2.00	RADMS21.0X2.0	72.32
M21	2.50	RADMS21.0X2.5	72.32
M22	1.00	RADMS22.0X1.0	72.32
M22	2.00	RADMS22.0X2.0	72.32
M23	1.00	RADMS23.0X1.0	72.32
M23	1.50	RADMS23.0X1.5	72.32
M23	2.00	RADMS23.0X2.0	72.32
M23	2.50	RADMS23.0X2.5	72.32
M24	1.50	RADMS24.0X1.5	72.32
M25	1.00	RADMS25.0X1.0	72.32
M25	1.50	RADMS25.0X1.5	72.32
M25	2.00	RADMS25.0X2.0	72.32
M25	2.50	RADMS25.0X2.5	72.32
M26	1.50	RADMS26.0X1.5	72.32
M26	2.00	RADMS26.0X2.0	72.32
M30	1.50	RADMS30.0X1.5	72.32
2-1/2" ROUND DIE			
M24	1.50	RADMS24.0X1.5*	105.52
M25	1.00	RADMS25.0X1.0*	105.52
M25	1.50	RADMS25.0X1.5*	105.52
M25	2.00	RADMS25.0X2.0*	105.52
M26	1.50	RADMS26.0X1.5*	105.52
M27	1.00	RADMS27.0X1.0	105.52
M27	1.50	RADMS27.0X1.5	105.52
M28	1.00	RADMS28.0X1.0	105.52
M28	1.50	RADMS28.0X1.5	105.52
M28	2.00	RADMS28.0X2.0	105.52
M30	1.00	RADMS30.0X1.0	105.52
M30	1.50	RADMS30.0X1.5*	105.52
M30	3.00	RADMS30.0X3.0	105.52
M32	1.50	RADMS32.0X1.5	105.52
M33	1.50	RADMS33.0X1.5	128.04
M34	1.50	RADMS34.0X1.50	105.52
M35	1.00	RADMS35.0X1.0	105.52
M35	1.50	RADMS35.0X1.50	105.52
M36	1.50	RADMS36.0X1.5	105.52
M36	2.00	RADMS36.0X2.0	105.52
M38	1.50	RADMS38.0X1.5	105.52
3" ROUND DIE			
M38	1.50	RADMS38.0X1.5*	200.02
M39	1.50	RADMS39.0X1.5	200.02
M40	1.50	RADMS40.0X1.5	200.02
M42	1.50	RADMS42.0X1.5	200.02
M42	3.00	RADMS42.0X3.00	200.02
M45	1.50	RADMS45.0X1.5	200.02
M45	3.00	RADMS45.0X3.0	200.02
M48	1.50	RADMS48.0X1.50	200.02
M48	3.00	RADMS48.0X3.00	200.02
M50	1.50	RADMS50.0X1.50	200.02
M52	1.50	RADMS52.0X1.50	200.02
M52	3.00	RADMS52.0X3.00	200.02

ROUND ADJUSTABLE (SPECIAL THREAD) DIES

ICS WIS

GENERAL PURPOSE

GROUND THREAD

SCREW ADJUSTING
TYPE

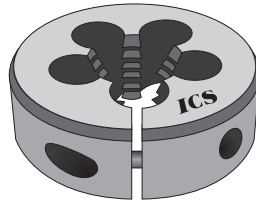

RIGHT HAND
CUT

BLACK & GOLD FINISH

Special Machine Screw and Fractional Sizes (#4 to 5/8")

SIZE	TPI	DIA	ITEM NO.	PRICE
1" ROUND DIE				
#4	36	1	RADS#04-36X100	28.22
#4	56	1	RADS#04-56X100	28.22
#4	60	1	RADS#04-60X100	28.22
#4	64	1	RADS#04-64X100	28.22
#5	48	1	RADS#05-48X100	28.22
#5	56	1	RADS#05-56X100	28.22
#5	64	1	RADS#05-64X100	28.22
#6	30	1	RADS#06-30X100	25.88
#6	36	1	RADS#06-36X100	25.88
#6	48	1	RADS#06-48X100	25.88
#6	56	1	RADS#06-56X100	25.88
#8	24	1	RADS#08-24X100	25.88
#8	30	1	RADS#08-30X100	25.88
#8	40	1	RADS#08-40X100	25.88
#8	48	1	RADS#08-48X100	25.88
#8	56	1	RADS#08-56X100	25.88
#10	26	1	RADS#10-26X100	25.88
#10	27	1	RADS#10-27X100	25.88
#10	28	1	RADS#10-28X100	25.88
#10	30	1	RADS#10-30X100	25.88
#10	36	1	RADS#10-36X100	25.88
#10	40	1	RADS#10-40X100	25.88
#10	48	1	RADS#10-48X100	25.88
#10	56	1	RADS#10-56X100	25.88
#12	26	1	RADS#12-26X100	25.88
#12	27	1	RADS#12-27X100	25.88
#12	30	1	RADS#12-30X100	25.88
#12	32	1	RADS#12-32X100	25.88
#12	36	1	RADS#12-36X100	25.88
#12	40	1	RADS#12-40X100	25.88
#12	48	1	RADS#12-48X100	25.88
#12	56	1	RADS#12-56X100	25.88
#14	27	1	RADS#14-27X100	25.88
#14	28	1	RADS#14-28X100	25.88
#14	30	1	RADS#14-30X100	25.88
#14	32	1	RADS#14-32X100	25.88
#14	48	1	RADS#14-48X100	25.88
1/4	14	1	RADS016-14X100	25.88
1/4	16	1	RADS016-16X100	25.88
1/4	18	1	RADS016-18X100	25.88
1/4	22	1	RADS016-22X100	25.88
1/4	24	1	RADS016-24X100	25.88
1/4	26	1	RADS016-26X100	25.88
1/4	27	1	RADS016-27X100	25.88
1/4	30	1	RADS016-30X100	25.88
1/4	32	1	RADS016-32X100	25.88
1/4	36	1	RADS016-36X100	25.88
1/4	40	1	RADS016-40X100	25.88
1/4	48	1	RADS016-48X100	25.88
1/4	56	1	RADS016-56X100	25.88
1/4	64	1	RADS016-64X100	25.88
5/16	16	1	RADS020-16X100	25.88
5/16	20	1	RADS020-20X100	25.88
5/16	22	1	RADS020-22X100	25.88
5/16	27	1	RADS020-27X100	25.88
5/16	28	1	RADS020-28X100	25.88
5/16	30	1	RADS020-30X100	25.88

SIZE	TPI	DIA	ITEM NO.	PRICE
1" ROUND DIE				
5/16	32	1	RADS020-32X100	25.88
5/16	36	1	RADS020-36X100	25.88
5/16	40	1	RADS020-40X100	25.88
5/16	48	1	RADS020-48X100	25.88
5/16	56	1	RADS020-56X100	25.88
3/8	14	1	RADS024-14X100	25.88
3/8	18	1	RADS024-18X100	25.88
3/8	20	1	RADS024-20X100	25.88
3/8	22	1	RADS024-22X100	25.88
3/8	26	1	RADS024-26X100	25.88
3/8	27	1	RADS024-27X100	25.88
3/8	28	1	RADS024-28X100	25.88
3/8	30	1	RADS024-30X100	25.88
3/8	32	1	RADS024-32X100	25.88
3/8	36	1	RADS024-36X100	25.88
3/8	40	1	RADS024-40X100	25.88
3/8	48	1	RADS024-48X100	25.88
7/16	16	1	RADS028-16X100	25.88
7/16	18	1	RADS028-18X100	25.88
7/16	24	1	RADS028-24X100	25.88
7/16	27	1	RADS028-27X100	25.88
7/16	28	1	RADS028-28X100	25.88
7/16	30	1	RADS028-30X100	25.88
7/16	32	1	RADS028-32X100	25.88
7/16	36	1	RADS028-36X100	25.88
7/16	40	1	RADS028-40X100	25.88
7/16	48	1	RADS028-48X100	25.88
1/2	12	1	RADS032-12X100	25.88
1/2	14	1	RADS032-14X100	25.88
1/2	16	1	RADS032-16X100	25.88
1/2	18	1	RADS032-18X100	25.88
1/2	22	1	RADS032-22X100	25.88
1/2	24	1	RADS032-24X100	25.88
1/2	27	1	RADS032-27X100	25.88
1/2	28	1	RADS032-28X100	25.88
1/2	30	1	RADS032-30X100	25.88
1/2	32	1	RADS032-32X100	25.88
1/2	36	1	RADS032-36X100	25.88
1/2	40	1	RADS032-40X100	25.88
1/2	48	1	RADS032-48X100	25.88
1-1/2" ROUND DIE				
1/4	22	1-1/2	RADS016-22X132	41.16
1/4	24	1-1/2	RADS016-24X132	41.16
1/4	27	1-1/2	RADS016-27X132	41.16
1/4	30	1-1/2	RADS016-30X132	41.16
1/4	32	1-1/2	RADS016-32X132	41.16
1/4	36	1-1/2	RADS016-36X132	41.16
1/4	40	1-1/2	RADS016-40X132	41.16
1/4	48	1-1/2	RADS016-48X132	41.16
5/16	16	1-1/2	RADS020-16X132	41.16
5/16	20	1-1/2	RADS020-20X132	41.16
5/16	22	1-1/2	RADS020-22X132	41.16
5/16	27	1-1/2	RADS020-27X132	41.16
5/16	28	1-1/2	RADS020-28X132	41.16
5/16	30	1-1/2	RADS020-30X132	41.16
5/16	32	1-1/2	RADS020-32X132	41.16
5/16	36	1-1/2	RADS020-36X132	41.16
5/16	40	1-1/2	RADS020-40X132	41.16

SIZE	TPI	DIA	ITEM NO.	PRICE
1-1/2" ROUND DIE				
5/16	48	1-1/2	RADS020-48X132	41.16
3/8	14	1-1/2	RADS024-14X132	41.16
3/8	18	1-1/2	RADS024-18X132	41.16
3/8	20	1-1/2	RADS024-20X132	41.16
3/8	22	1-1/2	RADS024-22X132	41.16
3/8	26	1-1/2	RADS024-26X132	41.16
3/8	27	1-1/2	RADS024-27X132	41.16
3/8	28	1-1/2	RADS024-28X132	41.16
3/8	30	1-1/2	RADS024-30X132	41.16
3/8	32	1-1/2	RADS024-32X132	41.16
3/8	36	1-1/2	RADS024-36X132	41.16
3/8	40	1-1/2	RADS024-40X132	41.16
3/8	48	1-1/2	RADS024-48X132	41.16
7/16	12	1-1/2	RADS028-12X132	41.16
7/16	16	1-1/2	RADS028-16X132	41.16
7/16	18	1-1/2	RADS028-18X132	41.16
7/16	22	1-1/2	RADS028-22X132	41.16
7/16	24	1-1/2	RADS028-24X132	41.16
7/16	27	1-1/2	RADS028-27X132	41.16
7/16	28	1-1/2	RADS028-28X132	41.16
7/16	30	1-1/2	RADS028-30X132	41.16
7/16	32	1-1/2	RADS028-32X132	41.16
7/16	36	1-1/2	RADS028-36X132	41.16
7/16	40	1-1/2	RADS028-40X132	41.16
7/16	48	1-1/2	RADS028-48X132	41.16
15/32	32	1-1/2	RADS030-32X132	41.16
1/2	12	1-1/2	RADS032-12X132	41.16
1/2	14	1-1/2	RADS032-14X132	41.16
1/2	16	1-1/2	RADS032-16X132	41.16
1/2	18	1-1/2	RADS032-18X132	41.16
1/2	22	1-1/2	RADS032-22X132	41.16
1/2	24	1-1/2	RADS032-24X132	41.16
1/2	27	1-1/2	RADS032-27X132	41.16
1/2	28	1-1/2	RADS032-28X132	41.16
1/2	30	1-1/2	RADS032-30X132	41.16
1/2	32	1-1/2	RADS032-32X132	41.16
1/2	36	1-1/2	RADS032-36X132	41.16
1/2	40	1-1/2	RADS032-40X132	41.16
1/2	48	1-1/2	RADS032-48X132	41.16
1/2	56	1-1/2	RADS032-56X132	41.16
9/16	14	1-1/2	RADS036-14X132	41.16
9/16	16	1-1/2	RADS036-16X132	41.16
9/16	20	1-1/2	RADS036-20X132	41.16
9/16	22	1-1/2	RADS036-22X132	41.16
9/16	24	1-1/2	RADS036-24X132	41.16
9/16	27	1-1/2	RADS036-27X132	41.16
9/16	28	1-1/2	RADS036-28X132	41.16
9/16	30	1-1/2	RADS036-30X132	41.16
9/16	32	1-1/2	RADS036-32X132	41.16
9/16	36	1-1/2	RADS036-36X132	41.16
9/16	40	1-1/2	RADS036-40X132	41.16
5/8	10	1-1/2	RADS040-10X132	41.16
5/8	12	1-1/2	RADS040-12X132	41.16
5/8	14	1-1/2	RADS040-14X132	41.16
5/8	16	1-1/2	RADS040-16X132	41.16
5/8	20	1-1/2	RADS040-20X132	41.16
5/8	22	1-1/2	RADS040-22X132	41.16

ROUND ADJUSTABLE (SPECIAL THREAD) DIES

ICS WIS

GENERAL PURPOSE

GROUND THREAD

SCREW ADJUSTING TYPE

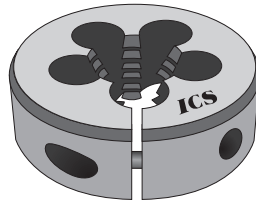

RIGHT HAND CUT

BLACK & GOLD FINISH

Special Fractional Sizes (5/8" to 1-3/16")

SIZE	TPI	DIA	ITEM NO.	PRICE
1-1/2" ROUND DIE				
5/8	24	1-1/2	RADS040-24X132	41.16
5/8	26	1-1/2	RADS040-26X132	41.16
5/8	27	1-1/2	RADS040-27X132	41.16
5/8	28	1-1/2	RADS040-28X132	41.16
5/8	30	1-1/2	RADS040-30X132	41.16
5/8	32	1-1/2	RADS040-32X132	41.16
5/8	36	1-1/2	RADS040-36X132	41.16
5/8	40	1-1/2	RADS040-40X132	41.16
5/8	48	1-1/2	RADS040-48X132	41.16
11/16	12	1-1/2	RADS044-12X132	41.16
11/16	14	1-1/2	RADS044-14X132	41.16
11/16	18	1-1/2	RADS044-18X132	41.16
11/16	20	1-1/2	RADS044-20X132	41.16
11/16	24	1-1/2	RADS044-24X132	41.16
11/16	27	1-1/2	RADS044-27X132	41.16
11/16	30	1-1/2	RADS044-30X132	41.16
11/16	32	1-1/2	RADS044-32X132	41.16
3/4	12	1-1/2	RADS048-12X132	41.16
3/4	14	1-1/2	RADS048-14X132	41.16
3/4	18	1-1/2	RADS048-18X132	41.16
3/4	20	1-1/2	RADS048-20X132	41.16
3/4	24	1-1/2	RADS048-24X132	41.16
3/4	27	1-1/2	RADS048-27X132	41.16
3/4	28	1-1/2	RADS048-28X132	41.16
3/4	30	1-1/2	RADS048-30X132	41.16
3/4	32	1-1/2	RADS048-32X132	41.16
3/4	36	1-1/2	RADS048-36X132	41.16
3/4	40	1-1/2	RADS048-40X132	41.16
3/4	48	1-1/2	RADS048-48X132	41.16
13/16	10	1-1/2	RADS052-10X132	41.16
13/16	12	1-1/2	RADS052-12X132	41.16
13/16	16	1-1/2	RADS052-16X132	41.16
13/16	20	1-1/2	RADS052-20X132	41.16
13/16	24	1-1/2	RADS052-24X132	41.16
13/16	28	1-1/2	RADS052-28X132	41.16
13/16	32	1-1/2	RADS052-32X132	41.16
2" ROUND DIE				
7/16	18	2	RADS028-18X200	72.32
7/16	24	2	RADS028-24X200	72.32
1/2	12	2	RADS032-12X200	72.32
1/2	16	2	RADS032-16X200	72.32
1/2	18	2	RADS032-18X200	72.32
1/2	24	2	RADS032-24X200	72.32
1/2	27	2	RADS032-27X200	72.32
1/2	28	2	RADS032-28X200	72.32
1/2	30	2	RADS032-30X200	72.32
1/2	32	2	RADS032-32X200	72.32
9/16	14	2	RADS036-14X200	72.32
9/16	20	2	RADS036-20X200	72.32
9/16	24	2	RADS036-24X200	72.32
9/16	27	2	RADS036-27X200	72.32
9/16	28	2	RADS036-28X200	72.32
9/16	30	2	RADS036-30X200	72.32
9/16	32	2	RADS036-32X200	72.32
9/16	36	2	RADS036-36X200	72.32
5/8	10	2	RADS040-10X200	72.32
5/8	12	2	RADS040-12X200	72.32
5/8	14	2	RADS040-14X200	72.32

SIZE	TPI	DIA	ITEM NO.	PRICE
2" ROUND DIE				
5/8	16	2	RADS040-16X200	72.32
5/8	20	2	RADS040-20X200	72.32
5/8	24	2	RADS040-24X200	72.32
5/8	27	2	RADS040-27X200	72.32
5/8	28	2	RADS040-28X200	72.32
5/8	30	2	RADS040-30X200	72.32
5/8	32	2	RADS040-32X200	72.32
5/8	40	2	RADS040-40X200	72.32
11/16	12	2	RADS044-12X200	72.32
11/16	14	2	RADS044-14X200	72.32
11/16	18	2	RADS044-18X200	72.32
11/16	20	2	RADS044-20X200	72.32
11/16	24	2	RADS044-24X200	72.32
11/16	27	2	RADS044-27X200	72.32
11/16	32	2	RADS044-32X200	72.32
11/16	36	2	RADS044-36X200	72.32
11/16	40	2	RADS044-40X200	72.32
3/4	12	2	RADS048-12X200	72.32
3/4	14	2	RADS048-14X200	72.32
3/4	18	2	RADS048-18X200	72.32
3/4	20	2	RADS048-20X200	72.32
3/4	24	2	RADS048-24X200	72.32
3/4	27	2	RADS048-27X200	72.32
3/4	28	2	RADS048-28X200	72.32
3/4	32	2	RADS048-32X200	72.32
3/4	36	2	RADS048-36X200	72.32
3/4	40	2	RADS048-40X200	72.32
13/16	10	2	RADS052-10X200	72.32
13/16	12	2	RADS052-12X200	72.32
13/16	14	2	RADS052-14X200	72.32
13/16	16	2	RADS052-16X200	72.32
13/16	18	2	RADS052-18X200	72.32
13/16	20	2	RADS052-20X200	72.32
13/16	24	2	RADS052-24X200	72.32
13/16	27	2	RADS052-27X200	72.32
13/16	30	2	RADS052-30X200	72.32
13/16	32	2	RADS052-32X200	72.32
13/16	36	2	RADS052-36X200	72.32
13/16	40	2	RADS052-40X200	72.32
7/8	10	2	RADS056-10X200	72.32
7/8	12	2	RADS056-12X200	72.32
7/8	16	2	RADS056-16X200	72.32
7/8	18	2	RADS056-18X200	72.32
7/8	20	2	RADS056-20X200	72.32
7/8	24	2	RADS056-24X200	72.32
7/8	27	2	RADS056-27X200	72.32
7/8	28	2	RADS056-28X200	72.32
7/8	30	2	RADS056-30X200	72.32
7/8	32	2	RADS056-32X200	72.32
7/8	36	2	RADS056-36X200	72.32
7/8	40	2	RADS056-40X200	72.32
15/16	10	2	RADS060-10X200	72.32
15/16	12	2	RADS060-12X200	72.32
15/16	14	2	RADS060-14X200	72.32
15/16	16	2	RADS060-16X200	72.32
15/16	18	2	RADS060-18X200	72.32
15/16	20	2	RADS060-20X200	72.32
15/16	24	2	RADS060-24X200	72.32

SIZE	TPI	DIA	ITEM NO.	PRICE
2" ROUND DIE				
15/16	27	2	RADS060-27X200	72.32
15/16	30	2	RADS060-30X200	72.32
15/16	32	2	RADS060-32X200	72.32
1	10	2	RADS100-10X200	72.32
1	16	2	RADS100-16X200	72.32
1	18	2	RADS100-18X200	72.32
1	20	2	RADS100-20X200	72.32
1	24	2	RADS100-24X200	72.32
1	27	2	RADS100-27X200	72.32
1	28	2	RADS100-28X200	72.32
1	30	2	RADS100-30X200	72.32
1	32	2	RADS100-32X200	72.32
1	36	2	RADS100-36X200	72.32
1	40	2	RADS100-40X200	72.32
1	48	2	RADS100-48X200	72.32
1	56	2	RADS100-56X200	72.32
1-1/16	12	2	RADS104-12X200	72.32
1-1/16	14	2	RADS104-14X200	72.32
1-1/16	16	2	RADS104-16X200	72.32
1-1/16	18	2	RADS104-18X200	72.32
2-1/2" ROUND DIE				
1	10	2-1/2	RADS100-10X232	105.52
1	16	2-1/2	RADS100-16X232	105.52
1	18	2-1/2	RADS100-18X232	105.52
1	20	2-1/2	RADS100-20X232	105.52
1	24	2-1/2	RADS100-24X232	105.52
1	26	2-1/2	RADS100-26X232	105.52
1	27	2-1/2	RADS100-27X232	105.52
1	28	2-1/2	RADS100-28X232	105.52
1	32	2-1/2	RADS100-32X232	105.52
1-1/16	7	2-1/2	RADS104-07X232	105.52
1-1/16	8	2-1/2	RADS104-08X232	105.52
1-1/16	10	2-1/2	RADS104-10X232	105.52
1-1/16	12	2-1/2	RADS104-12X232	105.52
1-1/16	14	2-1/2	RADS104-14X232	105.52
1-1/16	16	2-1/2	RADS104-16X232	105.52
1-1/16	18	2-1/2	RADS104-18X232	105.52
1-1/16	20	2-1/2	RADS104-20X232	105.52
1-1/16	24	2-1/2	RADS104-24X232	105.52
1-1/16	28	2-1/2	RADS104-28X232	105.52
1-1/8	8	2-1/2	RADS108-08X232	105.52
1-1/8	10	2-1/2	RADS108-10X232	105.52
1-1/8	14	2-1/2	RADS108-14X232	105.52
1-1/8	16	2-1/2	RADS108-16X232	105.52
1-1/8	18	2-1/2	RADS108-18X232	105.52
1-1/8	20	2-1/2	RADS108-20X232	105.52
1-1/8	24	2-1/2	RADS108-24X232	105.52
1-1/8	27	2-1/2	RADS108-27X232	105.52
1-1/8	28	2-1/2	RADS108-28X232	105.52
1-1/8	30	2-1/2	RADS108-30X232	105.52
1-1/8	32	2-1/2	RADS108-32X232	105.52
1-3/16	7	2-1/2	RADS112-07X232	105.52
1-3/16	8	2-1/2	RADS112-08X232	105.52
1-3/16	12	2-1/2	RADS112-12X232	105.52
1-3/16	14	2-1/2	RADS112-14X232	105.52
1-3/16	16	2-1/2	RADS112-16X232	105.52
1-3/16	18	2-1/2	RADS112-18X232	105.52
1-3/16	20	2-1/2	RADS112-20X232	105.52

HIGH SPEED STEEL ROUND ADJUSTABLE (SPECIAL THREAD) DIES

ICS **WIS**

GENERAL PURPOSE

GROUND THREAD

**SCREW
ADJUSTING TYPE**

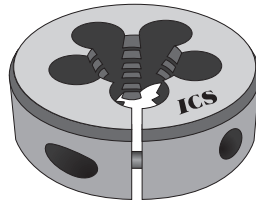

**RIGHT HAND
CUT**

BLACK & GOLD FINISH

Special Fractional Sizes (1-3/16" to 3-1/2")

SIZE	TPI	DIA	ITEM NO.	PRICE
2-1/2" ROUND DIE				
1-3/16	24	2-1/2	RADS112-24X232	105.52
1-3/16	27	2-1/2	RADS112-27X232	105.52
1-3/16	28	2-1/2	RADS112-28X232	105.52
1-3/16	32	2-1/2	RADS112-32X232	105.52
1-1/4	8	2-1/2	RADS116-08X232	105.52
1-1/4	10	2-1/2	RADS116-10X232	105.52
1-1/4	14	2-1/2	RADS116-14X232	105.52
1-1/4	16	2-1/2	RADS116-16X232	105.52
1-1/4	18	2-1/2	RADS116-18X232	105.52
1-1/4	20	2-1/2	RADS116-20X232	105.52
1-1/4	24	2-1/2	RADS116-24X232	105.52
1-1/4	27	2-1/2	RADS116-27X232	105.52
1-1/4	28	2-1/2	RADS116-28X232	105.52
1-1/4	30	2-1/2	RADS116-30X232	105.52
1-1/4	32	2-1/2	RADS116-32X232	105.52
1-1/4	36	2-1/2	RADS116-36X232	105.52
1-1/4	40	2-1/2	RADS116-40X232	105.52
1-5/16	8	2-1/2	RADS120-08X232	105.52
1-5/16	12	2-1/2	RADS120-12X232	105.52
1-5/16	14	2-1/2	RADS120-14X232	105.52
1-5/16	16	2-1/2	RADS120-16X232	105.52
1-5/16	18	2-1/2	RADS120-18X232	105.52
1-5/16	20	2-1/2	RADS120-20X232	105.52
1-5/16	24	2-1/2	RADS120-24X232	105.52
1-5/16	27	2-1/2	RADS120-27X232	105.52
1-5/16	32	2-1/2	RADS120-32X232	105.52
1-3/8	7	2-1/2	RADS124-07X232	105.52
1-3/8	8	2-1/2	RADS124-08X232	105.52
1-3/8	10	2-1/2	RADS124-10X232	105.52
1-3/8	14	2-1/2	RADS124-14X232	105.52
1-3/8	16	2-1/2	RADS124-16X232	105.52
1-3/8	18	2-1/2	RADS124-18X232	105.52
1-3/8	20	2-1/2	RADS124-20X232	105.52
1-3/8	24	2-1/2	RADS124-24X232	105.52
1-3/8	27	2-1/2	RADS124-27X232	105.52
1-3/8	32	2-1/2	RADS124-32X232	105.52
1-7/16	6	2-1/2	RADS128-06X232	105.52
1-7/16	8	2-1/2	RADS128-08X232	105.52
1-7/16	12	2-1/2	RADS128-12X232	105.52
1-7/16	16	2-1/2	RADS128-16X232	105.52
1-7/16	18	2-1/2	RADS128-18X232	105.52
1-1/2	7	2-1/2	RADS132-07X232	105.52
1-1/2	8	2-1/2	RADS132-08X232	105.52
1-1/2	10	2-1/2	RADS132-10X232	105.52
1-1/2	14	2-1/2	RADS132-14X232	105.52
1-1/2	16	2-1/2	RADS132-16X232	105.52
1-1/2	18	2-1/2	RADS132-18X232	105.52
1-1/2	20	2-1/2	RADS132-20X232	105.52
1-1/2	24	2-1/2	RADS132-24X232	105.52
1-1/2	27	2-1/2	RADS132-27X232	105.52
1-1/2	30	2-1/2	RADS132-30X232	105.52
1-1/2	32	2-1/2	RADS132-32X232	105.52
3" ROUND DIE				
1	10	3	RADS100-10X300	200.02
1	16	3	RADS100-16X300	200.02
1	18	3	RADS100-18X300	200.02
1	20	3	RADS100-20X300	200.02
1	24	3	RADS100-24X300	200.02

SIZE	TPI	DIA	ITEM NO.	PRICE
3" ROUND DIE				
1-1/16	8	3	RADS104-08X300	200.02
1-1/16	10	3	RADS104-10X300	200.02
1-1/16	12	3	RADS104-12X300	200.02
1-1/16	14	3	RADS104-14X300	200.02
1-1/16	16	3	RADS104-16X300	200.02
1-1/16	18	3	RADS104-18X300	200.02
1-1/16	20	3	RADS104-20X300	200.02
1-1/16	24	3	RADS104-24X300	200.02
1-1/8	8	3	RADS108-08X300	200.02
1-1/8	10	3	RADS108-10X300	200.02
1-1/8	14	3	RADS108-14X300	200.02
1-1/8	16	3	RADS108-16X300	200.02
1-1/8	18	3	RADS108-18X300	200.02
1-1/8	20	3	RADS108-20X300	200.02
1-1/8	24	3	RADS108-24X300	200.02
1-3/16	8	3	RADS112-08X300	200.02
1-3/16	12	3	RADS112-12X300	200.02
1-3/16	16	3	RADS112-16X300	200.02
1-1/4	6	3	RADS116-06X300	200.02
1-1/4	8	3	RADS116-08X300	200.02
1-1/4	10	3	RADS116-10X300	200.02
1-1/4	14	3	RADS116-14X300	200.02
1-1/4	16	3	RADS116-16X300	200.02
1-1/4	18	3	RADS116-18X300	200.02
1-1/4	20	3	RADS116-20X300	200.02
1-1/4	24	3	RADS116-24X300	200.02
1-5/16	8	3	RADS120-08X300	200.02
1-5/16	10	3	RADS120-10X300	200.02
1-5/16	12	3	RADS120-12X300	200.02
1-5/16	14	3	RADS120-14X300	200.02
1-5/16	16	3	RADS120-16X300	200.02
1-5/16	18	3	RADS120-18X300	200.02
1-5/16	20	3	RADS120-20X300	200.02
1-3/8	8	3	RADS124-08X300	200.02
1-3/8	10	3	RADS124-10X300	200.02
1-3/8	14	3	RADS124-14X300	200.02
1-3/8	16	3	RADS124-16X300	200.02
1-3/8	18	3	RADS124-18X300	200.02
1-3/8	20	3	RADS124-20X300	200.02
1-3/8	24	3	RADS124-24X300	200.02
1-7/16	6	3	RADS128-06X300	200.02
1-7/16	8	3	RADS128-08X300	200.02
1-7/16	12	3	RADS128-12X300	200.02
1-7/16	16	3	RADS128-16X300	200.02
1-7/16	18	3	RADS128-18X300	200.02
1-1/2	8	3	RADS132-08X300	200.02
1-1/2	10	3	RADS132-10X300	200.02
1-1/2	14	3	RADS132-14X300	200.02
1-1/2	16	3	RADS132-16X300	200.02
1-1/2	18	3	RADS132-18X300	200.02
1-1/2	20	3	RADS132-20X300	200.02
1-1/2	24	3	RADS132-24X300	200.02
1-9/16	6	3	RADS136-06X300	200.02
1-9/16	8	3	RADS136-08X300	200.02
1-9/16	12	3	RADS136-12X300	200.02
1-9/16	16	3	RADS136-16X300	200.02
1-9/16	18	3	RADS136-18X300	200.02
1-5/8	5	3	RADS140-05X300	200.02

SIZE	TPI	DIA	ITEM NO.	PRICE
3" ROUND DIE				
1-5/8	5-1/2	3	RADS140-5.5X300	200.02
1-5/8	6	3	RADS140-06X300	200.02
1-5/8	8	3	RADS140-08X300	200.02
1-5/8	10	3	RADS140-10X300	200.02
1-5/8	12	3	RADS140-12X300	200.02
1-5/8	14	3	RADS140-14X300	200.02
1-5/8	18	3	RADS140-18X300	200.02
1-5/8	20	3	RADS140-20X300	200.02
1-11/16	6	3	RADS144-06X300	200.02
1-11/16	8	3	RADS144-08X300	200.02
1-11/16	12	3	RADS144-12X300	200.02
1-11/16	18	3	RADS144-18X300	200.02
1-3/4	5-1/2	3	RADS148-5.5X300	200.02
1-3/4	6	3	RADS148-06X300	200.02
1-3/4	8	3	RADS148-08X300	200.02
1-3/4	10	3	RADS148-10X300	200.02
1-3/4	14	3	RADS148-14X300	200.02
1-3/4	16	3	RADS148-16X300	200.02
1-3/4	20	3	RADS148-20X300	200.02
1-3/4	24	3	RADS148-24X300	200.02
1-7/8	5	3	RADS156-05X300	200.02
1-7/8	5-1/2	3	RADS156-5.5X300	200.02
1-7/8	6	3	RADS156-06X300	200.02
1-7/8	8	3	RADS156-08X300	200.02
1-7/8	10	3	RADS156-10X300	200.02
1-7/8	12	3	RADS156-12X300	200.02
1-7/8	14	3	RADS156-14X300	200.02
1-7/8	16	3	RADS156-16X300	200.02
1-7/8	18	3	RADS156-18X300	200.02
1-7/8	20	3	RADS156-20X300	200.02
2	4	3	RADS200-04X300	200.02
2	6	3	RADS200-06X300	200.02
2	8	3	RADS200-08X300	200.02
2	10	3	RADS200-10X300	200.02
2	12	3	RADS200-12X300	200.02
2	14	3	RADS200-14X300	200.02
2	16	3	RADS200-16X300	200.02
2	18	3	RADS200-18X300	200.02
2	20	3	RADS200-20X300	200.02
2	24	3	RADS200-24X300	200.02
4" ROUND DIE				
2-1/8	18	4	RADS208-18X400	-
2-1/4	8	4	RADS216-08X400	-
2-1/4	16	4	RADS216-16X400	CALL FOR PRICE
2-3/8	16	4	RADS224-16X400	CALL FOR PRICE
2-1/2	8	4	RADS232-08X400	-
2-3/4	12	4	RADS248-12X400	-
3	8	4	RADS300-08X400	-
5" ROUND DIE				
2-5/8	12	5	RADS240-12X500	-
2-5/8	16	5	RADS240-16X500	-
2-3/4	8	5	RADS248-08X500	CALL FOR PRICE
2-3/4	12	5	RADS248-12X500	CALL FOR PRICE
3-1/4	12	5	RADS316-12X500	-
3-1/2	12	5	RADS332-12X500	-

ROUND ADJUSTABLE (TAPER PIPE) DIES

ICS WIS

GENERAL PURPOSE

GROUND THREAD

SCREW
ADJUSTING TYPE

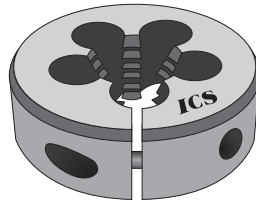

RIGHT HAND
CUT

BLACK & GOLD FINISH

Fractional Sizes (1/16" To 3" Dia.)

SIZE	TPI	DIA	ITEM NO.	PRICE
1" ROUND DIE				
1/16	27	1	RADP004X27	25.88
1/8	27	1	RADP008X27	25.88
1/4	18	1	RADP016X18X100	27.46
1-1/2" ROUND DIE				
1/8	27	1-1/2	RADP008X27X1.5	41.16
1/4	18	1-1/2	RADP016X18	41.16
3/8	18	1-1/2	RADP024X18	41.16
1/2	14	1-1/2	RADP032X14X1.5	41.16
2" ROUND DIE				
1/4	18	2	RADP016X18X200	72.32
3/8	18	2	RADP024X18X200	72.32
1/2	14	2	RADP032X14	72.32
3/4	14	2	RADP048X14	72.32

SIZE	TPI	DIA	ITEM NO.	PRICE
2-1/2" ROUND DIE				
1	11-1/2	2-1/2	RADP100X11.5	100.56
3" ROUND DIE				
1-1/4	11-1/2	3	RADP116X11.5	179.94
1-1/2	11-1/2	3	RADP132X11.5	179.94
4" ROUND DIE				
1-1/2	11-1/2	4	RADP132X11.5X4	313.30
2	11-1/2	4	RADP200X11.5	313.30
5" ROUND DIE				
2-1/2	8	4	RADP232X08	421.26
3	8	4	RADP300X08	421.26

ROUND ADJUSTABLE (STRAIGHT PIPE) DIES

ICS WIS

GENERAL PURPOSE

GROUND THREAD

SCREW
ADJUSTING TYPE

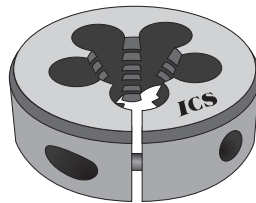

RIGHT HAND
CUT

BLACK & GOLD FINISH

Fractional Sizes (1/16" To 2" Dia.)

SIZE	TPI	DIA	ITEM NO.	PRICE
1" ROUND DIE				
1/16	27	1	RADPS004-27	25.88
1/8	27	1	RADPS008-27	25.88
1-1/2" ROUND DIE				
1/8	27	1-1/2	RADPS008-27*	41.16
1/4	18	1-1/2	RADPS016-18	41.16
3/8	18	1-1/2	RADPS024-18	41.16
1/2	14	1-1/2	RADPS032-14*	41.16
2" ROUND DIE				
1/8	27	2	RADPS008-27X2	72.32
1/4	18	2	RADPS016-18X2	72.32
3/8	18	2	RADPS024-18X2	72.32
1/2	14	2	RADPS032-14	72.32
3/4	14	2	RADPS048-14	72.32

SIZE	TPI	DIA	ITEM NO.	PRICE
2-1/2" ROUND DIE				
1	11-1/2	2-1/2	RADPS100-11.5	103.60
3" ROUND DIE				
1-1/4	11-1/2	3	RADPS116-11.5	190.12
1-1/2	11-1/2	3	RADPS132-11.5	190.12
4" ROUND DIE				
2	11-1/2	4	RADPS200-11.5	408.98

NOTE: Larger Pipe Dies are available. Consult factory for pricing.

HIGH SPEED STEEL

BRITISH ROUND ADJUSTABLE (TAPER PIPE) DIES

ICS WIS

GENERAL PURPOSE

GROUND THREAD

British (BSPT) Standard Pipe Taper Thread Dies are the metric/European equivalent of American (NPT) Standard Pipe Taper Threads. **Note:** American and British Standards are not interchangeable.

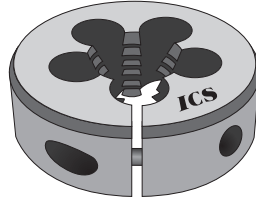

BLACK & GOLD FINISH

**SCREW
ADJUSTING TYPE**

**RIGHT HAND
CUT**

Fractional Sizes (1/8" To 2" Dia.)

SIZE	TPI	DIA	ITEM NO.	PRICE
1" ROUND DIE				
1/8	28	1	BSPTRAD008-28A	39.48
1/4	19	1	BSPTRAD016-19A	39.48
1-1/2" ROUND DIE				
1/4	19	1-1/2	BSPTRAD016-19B	62.16
3/8	19	1-1/2	BSPTRAD024-19B	62.16
2" ROUND DIE				
1/2	14	2	BSPTRAD032-14C	88.20
5/8	14	2	BSPTRAD040-14C	88.20
3/4	14	2	BSPTRAD048-14C	108.20

SIZE	TPI	DIA	ITEM NO.	PRICE
2-1/2" ROUND DIE				
7/8	14	2-1/2	BSPTRAD056-14D	109.20
1	11	2-1/2	BSPTRAD100-11D	109.20
3" ROUND DIE				
1-1/4	11	3	BSPTRAD116-11E	CALL
1-1/2	11	3	BSPTRAD132-11E	217.56
4" ROUND DIE				
2	11	4	BSPTRAD200-11F	367.50

HIGH SPEED STEEL

BRITISH ROUND ADJUSTABLE (PARALLEL PIPE) DIES

ICS WIS

GENERAL PURPOSE

GROUND THREAD

British (BSPP) Standard Pipe Parallel Thread Dies are the metric/European equivalent of American (NPS) Standard Pipe Straight Threads. **Note:** American and British Standards are not interchangeable.

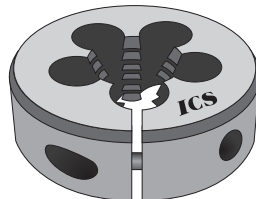

BLACK & GOLD FINISH

**SCREW
ADJUSTING TYPE**

**RIGHT HAND
CUT**

Fractional Sizes (1/8" To 2" Dia.)

SIZE	TPI	DIA	ITEM NO.	PRICE
1" ROUND DIE				
1/8	28	1	BSPPRAD008-28A	39.48
1-1/2" ROUND DIE				
1/4	19	1-1/2	BSPPRAD016-19B	62.16
3/8	19	1-1/2	BSPPRAD024-19B	62.16
2" ROUND DIE				
1/2	14	2	BSPPRAD032-14C	88.20
5/8	14	2	BSPPRAD040-14C	88.20
3/4	14	2	BSPPRAD048-14C	88.20

SIZE	TPI	DIA	ITEM NO.	PRICE
2-1/2" ROUND DIE				
7/8	14	2-1/2	BSPPRAD056-14D	109.20
1	11	2-1/2	BSPPRAD100-11D	109.20
3" ROUND DIE				
1-1/4	11	3	BSPPRAD116-11E	217.56
1-1/2	11	3	BSPPRAD132-11E	217.56
4" ROUND DIE				
2	11	4	BSPPRAD200-11F	367.50

NOTE: Larger Pipe Dies are available. Consult factory for pricing.

BEARING LOCKNUT HEXAGON RETHREADING DIES

ICS USA

HEAVY DUTY

GROUND THREAD

High Speed Steel Bearing Locknut Hexagon Rethreading Dies are designed for rethreading damaged threads on bearing locknut spindles and to clean out built up locking compound on threads. All dies conform to ABMA (American Bearing Manufacturer's Association) standards.

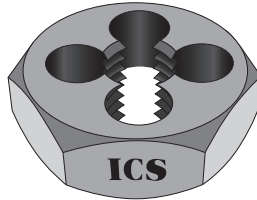

ABMA LOCKNUT NO.	THREAD SIZE	DIAMETER ACROSS FLATS	ITEM NO.	PRICE
#00	.391 - 32	7/8	BLHTD#00	-
#01	.469 - 32	1-1/16	BLHTD#01	-
#02	.586 - 32	1-1/4	BLHTD#02	-
#03	.664 - 32	1-7/16	BLHTD#03	-
#04	.781 - 32	1-5/8	BLHTD#04	-
#05	.969 - 32	1-13/16	BLHTD#05	CALL FOR PRICE
#06	1.173 - 18	2-3/16	BLHTD#06	CALL FOR PRICE
#07	1.376 - 18	2-3/8	BLHTD#07	CALL FOR PRICE
#08	1.563 - 18	3-1/8	BLHTD#08	-
#09	1.767 - 18	3-1/8	BLHTD#09	-
#10	1.967 - 18	3-1/2	BLHTD#10	-
#11	2.157 - 18	3-1/2	BLHTD#11	-
#12	2.360 - 18	4-1/2	BLHTD#12	-
#13	2.548 - 18	4-1/2	BLHTD#13	-

ABMA LOCKNUT NO.	THREAD SIZE	DIAMETER ACROSS FLATS	ITEM NO.	PRICE
#14	2.751 - 18	4-1/2	BLHTD#14	-
#15	2.933 - 12	5	BLHTD#15	-
#16	3.137 - 12	5	BLHTD#16	-
#17	3.340 - 12	5	BLHTD#17	-
#18	3.527 - 12	6	BLHTD#18	-
#19	3.730 - 12	6	BLHTD#19	CALL FOR PRICE
#20	3.918 - 12	6	BLHTD#20	CALL FOR PRICE
#21	4.122 - 12	7	BLHTD#21	CALL FOR PRICE
#22	4.325 - 12	7	BLHTD#22	-
#24	4.716 - 12	7	BLHTD#24	-
#26	5.106 - 12	8	BLHTD#26	-
#28	5.497 - 12	8	BLHTD#28	-
#30	5.888 - 12	8	BLHTD#30	-

CARBON STEEL

BEARING LOCKNUT HEXAGON RETHREADING DIES

ICS USA

GENERAL PURPOSE

CUT THREAD

Carbon Steel Bearing Locknut Hexagon Rethreading Dies are designed for rethreading damaged threads on bearing locknut spindles and to clean out built up locking compound on threads. All dies conform to ABMA (American Bearing Manufacturer's Association) standards.

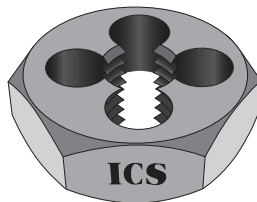

ABMA LOCKNUT NO.	THREAD SIZE	DIAMETER ACROSS FLATS	ITEM NO.	PRICE
#00	.391 - 32	7/8	BLHRD#00	-
#01	.469 - 32	1-1/16	BLHRD#01	-
#02	.586 - 32	1-1/4	BLHRD#02	-
#03	.664 - 32	1-7/16	BLHRD#03	-
#04	.781 - 32	1-5/8	BLHRD#04	-
#05	.969 - 32	1-13/16	BLHRD#05	CALL FOR PRICE
#06	1.173 - 18	2-3/16	BLHRD#06	CALL FOR PRICE
#07	1.376 - 18	2-3/8	BLHRD#07	CALL FOR PRICE
#08	1.563 - 18	3-1/8	BLHRD#08	-
#09	1.767 - 18	3-1/8	BLHRD#09	-
#10	1.967 - 18	3-1/2	BLHRD#10	-
#11	2.157 - 18	3-1/2	BLHRD#11	-
#12	2.360 - 18	4-1/2	BLHRD#12	-
#13	2.548 - 18	4-1/2	BLHRD#13	-

ABMA LOCKNUT NO.	THREAD SIZE	DIAMETER ACROSS FLATS	ITEM NO.	PRICE
#14	2.751 - 18	4-1/2	BLHRD#14	-
#15	2.933 - 12	5	BLHRD#15	-
#16	3.137 - 12	5	BLHRD#16	-
#17	3.340 - 12	5	BLHRD#17	-
#18	3.527 - 12	6	BLHRD#18	-
#19	3.730 - 12	6	BLHRD#19	-
#20	3.918 - 12	6	BLHRD#20	CALL FOR PRICE
#21	4.122 - 12	7	BLHRD#21	CALL FOR PRICE
#22	4.325 - 12	7	BLHRD#22	CALL FOR PRICE
#24	4.716 - 12	7	BLHRD#24	-
#26	5.106 - 12	8	BLHRD#26	-
#28	5.497 - 12	8	BLHRD#28	-
#30	5.888 - 12	8	BLHRD#30	-
#30	5.888 - 12	8	BLHTD#30	-

BEARING LOCKNUT ROUND ADJUSTABLE DIES

ICS USA

HEAVY DUTY

GROUND THREAD

High Speed Steel Bearing Locknut Round Adjustable Dies are designed for cutting external threads and rethreading damaged threads on bearing locknut spindles and to clean out built up locking compound on threads. They can also be used to cut smaller or larger than factory setting by turning the adjusting screw in or out. All dies conform to ABMA (American Bearing Manufacturer's Association) standards.

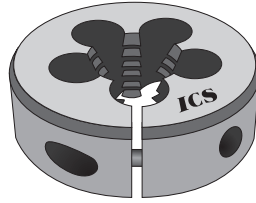

ABMA LOCKNUT NO.	THREAD SIZE	DIAMETER OF DIE	ITEM NO.	PRICE
#00	.391 - 32	1	BLRAD#00	-
#01	.469 - 32	1-1/2	BLRAD#01	-
#02	.586 - 32	1-1/2	BLRAD#02	-
#03	.664 - 32	1-1/2	BLRAD#03	-
#04	.781 - 32	1-1/2	BLRAD#04	-
#05	.969 - 32	2	BLRAD#05	CALL FOR PRICE
#06	1.173 - 18	2-1/2	BLRAD#06	CALL FOR PRICE
#07	1.376 - 18	2-1/2	BLRAD#07	CALL FOR PRICE
#08	1.563 - 18	3	BLRAD#08	-
#09	1.767 - 18	3	BLRAD#09	-
#10	1.967 - 18	3	BLRAD#10	-
#11	2.157 - 18	4	BLRAD#11	-
#12	2.360 - 18	4	BLRAD#12	-
#13	2.548 - 18	4	BLRAD#13	-

ABMA LOCKNUT NO.	THREAD SIZE	DIAMETER OF DIE	ITEM NO.	PRICE
#14	2.751 - 18	4	BLRAD#14	-
#15	2.933 - 12	5	BLRAD#15	-
#16	3.137 - 12	5	BLRAD#16	-
#17	3.340 - 12	5	BLRAD#17	-
#18	3.527 - 12	6	BLRAD#18	-
#19	3.730 - 12	6	BLRAD#19	CALL FOR PRICE
#20	3.918 - 12	6	BLRAD#20	CALL FOR PRICE
#21	4.122 - 12	7	BLRAD#21	CALL FOR PRICE
#22	4.325 - 12	7	BLRAD#22	-
#24	4.716 - 12	7	BLRAD#24	-
#26	5.106 - 12	8	BLRAD#26	-
#28	5.497 - 12	8	BLRAD#28	-
#30	5.888 - 12	8	BLRAD#30	-

COBALT
AUTOMATIC THREAD DIES

ICS WIS

SPECIAL PURPOSE

GROUND THREAD

Cobalt Automatic Thread Dies are designed for automatic thread cutting machines and lathes with 2 holding holes. Their solid cobalt construction design guarantees a precise repetitive accuracy and longer tool life than regular HSS dies.

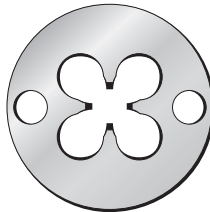

GOLD COBALT FINISH

2.60MM DIAMETER HOLDING HOLES

RIGHT HAND CUT

THREAD SIZE	DIAMETER OF DIE	THICKNESS OF DIE	ITEM NO.	PRICE
#0-80	16.00mm	3.75mm	ATDC#00-80	37.80
#2-56	16.00mm	3.75mm	ATDC#02-56	37.80
#4-40	16.00mm	3.75mm	ATDC#04-40	37.80
#6-32	16.00mm	3.75mm	ATDC#06-32	37.80
#8-32	16.00mm	3.75mm	ATDC#08-32	37.80
#10-32	16.00mm	3.75mm	ATDC#10-32	37.80
#12-28	16.00mm	3.75mm	ATDC#12-28	37.80

HIGH SPEED STEEL BRITISH ROUND ADJUSTABLE DIES

TT-51

ICS USA

GENERAL PURPOSE

GROUND THREAD

**PLAIN
ADJUSTABLE**

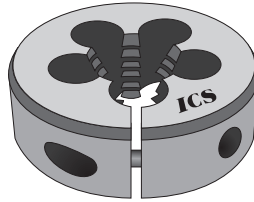

**RIGHT HAND
CUT**

SIZE	TPI	ITEM NO.	PRICE
1" ROUND DIE			
0	25.4	BRAD#00-25.4X1	38.82
1	28.4	BRAD#01-28.4X1	38.82
2	31.4	BRAD#02-31.4X1	38.82
3	34.8	BRAD#03-34.8X1	38.82
4	38.5	BRAD#04-38.5X1	38.82
5	43.0	BRAD#05-43.0X1	39.22
6	47.9	BRAD#06-47.9X1	38.82
7	52.9	BRAD#07-52.9X1	38.82
8	59.1	BRAD#08-59.1X1	38.82
9	65.1	BRAD#09-65.1X1	38.82
10	72.6	BRAD#10-72.6X1	38.82
12	90.7	BRAD#12-90.7X1	38.82
13/16" ROUND DIE			
1/8	40	BRAD008-40X052	31.16
3/16	24	BRAD012-24X052	31.16
3/16	32	BRAD012-32X052	CALL
1" ROUND DIE			
1/4	20	BRAD016-20X1	38.82
1/4	26	BRAD016-26X1	38.82
5/16	18	BRAD020-18X1	38.82
5/16	22	BRAD020-22X1	38.82

SIZE	TPI	ITEM NO.	PRICE
1" ROUND DIE			
3/8	16	BRAD024-16X1	38.82
3/8	20	BRAD024-20X1	38.82
1-1/2" ROUND DIE			
3/8	16	BRAD024-16X1.5	61.16
3/8	20	BRAD024-20X1.5	61.16
7/16	14	BRAD028-14X1.5	61.16
7/16	18	BRAD028-18X1.5	61.16
1/2	12	BRAD032-12X1.5	CALL
1/2	16	BRAD032-16X1.5	61.16
9/16	12	BRAD036-12X1.5	61.16
9/16	16	BRAD036-16X1.5	61.16
5/8	11	BRAD040-11X1.5	61.16
5/8	14	BRAD040-14X1.5	61.16
2" ROUND DIE			
1/2	12	BRAD032-12X2	108.20
1/2	16	BRAD032-16X2	108.20
9/16	12	BRAD036-12X2	108.20
9/16	16	BRAD036-16X2	108.20
5/8	11	BRAD040-11X2	108.20
5/8	14	BRAD040-14X2	108.20
3/4	10	BRAD048-10X2	108.20
3/4	12	BRAD048-12X2	108.20

SIZE	TPI	ITEM NO.	PRICE
2" ROUND DIE			
7/8	9	BRAD056-9X2	108.20
7/8	11	BRAD056-11X2	108.20
1	8	BRAD100-8X2	108.20
1	10	BRAD100-10X2	108.20
2-1/2" ROUND DIE			
3/4	10	BRAD048-10X2.5	165.82
3/4	12	BRAD048-12X2.5	165.82
7/8	9	BRAD056-9X2.5	165.82
7/8	11	BRAD056-11X2.5	165.82
1	8	BRAD100-8X2.5	165.82
1	10	BRAD100-10X2.5	165.82
1-1/8	7	BRAD108-7X2.5	165.82
1-1/8	9	BRAD108-9X2.5	165.82
3" ROUND DIE			
1-1/8	7	BRAD108-7X3	217.56
1-1/8	9	BRAD108-9X3	217.56
1-1/4	7	BRAD116-7X3	217.56
1-1/4	9	BRAD116-9X3	217.56
1-3/8	6	BRAD124-6X3	217.56
1-3/8	8	BRAD124-8X3	217.56
1-1/2	6	BRAD132-6X3	217.56
1-1/2	8	BRAD132-8X3	217.56

CARBON STEEL BRITISH HEXAGON RETHREADING DIES

ICS USA

GENERAL PURPOSE

CUT THREAD

**HEX NUT DIA.
ACROSS FLATS**

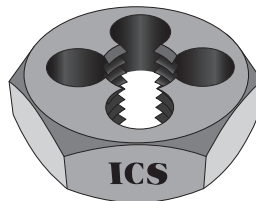

**RIGHT HAND
CUT**

SIZE	TPI	DIA. ACROSS FLATS	ITEM NO.	PRICE
3/16	24	.710	BHRD012-24	18.82
1/4	20	.710	BHRD016-20	19.08
1/4	26	.710	BHRD016-26	19.08
5/16	18	.820	BHRD020-18	21.00
5/16	22	.820	BHRD020-22	21.00
3/8	16	.920	BHRD024-16	22.34
3/8	20	.920	BHRD024-20	22.34
7/16	14	1.010	BHRD028-14	25.14
7/16	18	1.010	BHRD028-18	25.14
1/2	12	1.100	BHRD032-12	27.24
1/2	16	1.100	BHRD032-16	27.24

SIZE	TPI	DIA. ACROSS FLATS	ITEM NO.	PRICE
9/16	12	1.300	BHRD036-12	28.98
9/16	16	1.300	BHRD036-16	28.98
5/8	11	1.300	BHRD040-11	33.16
5/8	14	1.300	BHRD040-14	33.16
3/4	10	1.480	BHRD048-10	44.18
3/4	12	1.480	BHRD048-12	44.18
7/8	9	1.670	BHRD056-09	49.56
7/8	11	1.670	BHRD056-11	49.56
1	8	2.050	BHRD100-08	56.56
1	10	2.050	BHRD100-10	56.56

HEXAGON (STANDARD SIZES) RETHREADING DIES

ICS WIS

GENERAL PURPOSE

CUT THREAD

Hexagon (Hex Nut Diameter) Rethreading Dies are designed extra thick for rethreading damaged or jammed threads and can be used to work in places where round die stocks cannot be used. They are not intended for producing new threads on unthreaded bars, bolts, or pipes. Available in almost any threading size. All sizes are manufactured to be the same size as a Hex Nut of equal thread size.

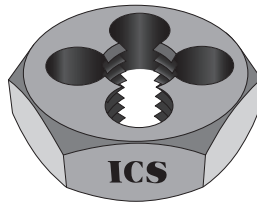

HEX NUT DIA.
ACROSS FLATS

RIGHT HAND
CUT

DIA. ACROSS FLATS		ITEM NO.	PRICE
SIZE	TPI		
2	56	HRD#02-56	7.98
2	64	HRD#02-64	7.98
3	48	HRD#03-48	7.98
3	56	HRD#03-56	7.98
4	36	HRD#04-36	7.98
4	40	HRD#04-40	7.98
4	48	HRD#04-48	7.98
5	40	HRD#05-40	7.98
5	44	HRD#05-44	7.98
6	32	HRD#06-32	7.98
6	40	HRD#06-40	7.98
8	32	HRD#08-32	7.98
8	36	HRD#08-36	7.98
10	24	HRD#10-24	7.98
10	32	HRD#10-32	7.98
12	24	HRD#12-24	7.98
12	28	HRD#12-28	7.98
1/4	20	HRD016-20	7.98
1/4	28	HRD016-28	7.98
5/16	18	HRD020-18	8.96
5/16	24	HRD020-24	8.96

DIA. ACROSS FLATS		ITEM NO.	PRICE
SIZE	TPI		
3/8	16	HRD024-16	10.00
3/8	24	HRD024-24	10.00
7/16	14	HRD028-14	11.54
7/16	20	HRD028-20	11.54
1/2	13	HRD032-13	13.52
1/2	20	HRD032-20	13.52
9/16	12	HRD036-12	15.94
9/16	18	HRD036-18	15.94
5/8	11	HRD040-11	18.54
5/8	18	HRD040-18	18.54
11/16	11	HRD044-11	23.52
11/16	16	HRD044-16	23.52
3/4	10	HRD048-10	23.52
3/4	16	HRD048-16	23.52
7/8	9	HRD056-09	27.28
7/8	14	HRD056-14	27.28
1	8	HRD100-08	34.58
1	12	HRD100-12	34.58
1	14	HRD100-14	34.58
1-1/8	7	HRD108-07	47.36
1-1/8	12	HRD108-12	47.36

DIA. ACROSS FLATS		ITEM NO.	PRICE
SIZE	TPI		
1-1/4	7	HRD116-07	54.52
1-1/4	12	HRD116-12	54.52
1-3/8	6	HRD124-06	70.46
1-3/8	12	HRD124-12	70.46
1-1/2	6	HRD132-06	78.40
1-1/2	12	HRD132-12	78.40
1-5/8	5-1/2	HRD140-05.5	110.20
1-3/4	5	HRD148-05	128.08
1-7/8	5	HRD156-05	178.28
2	4-1/2	HRD200-04.5	178.28
2-1/4	4-1/2	HRD216-04.5	193.12
2-1/2	4	HRD232-04	278.56
2-3/4	4	HRD248-04	337.56
3	4	HRD300-04	416.02
3-1/4	4	HRD316-04	484.64
3-1/2	4	HRD332-04	484.64
3-3/4	4	HRD348-04	566.24
4	4	HRD400-04	623.54

LEFT HAND HEXAGON RETHREADING DIES

ICS WIS

SPECIAL PURPOSE

CUT THREAD

Left Hand Hexagon (Hex Nut Diameter) Rethreading Dies are designed extra thick for rethreading damaged or jammed threads and can be used to work in places where round die stocks cannot be used. They are not intended for producing new threads on unthreaded bars, bolts, or pipes. All sizes are manufactured to be the same size as a Hex Nut of equal thread size. They are available in almost any threading size. If size needed is not listed, contact us for price and availability.

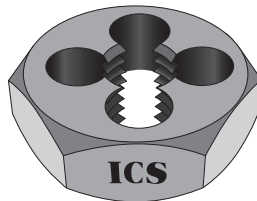

HEX NUT DIA.
ACROSS FLATS

RIGHT HAND
CUT

DIA. ACROSS FLATS		ITEM NO.	PRICE
SIZE	TPI		
1/4	20	HRDL016-20	11.50
1/4	28	HRDL016-28	11.50
5/16	18	HRDL020-18	12.74
5/16	24	HRDL020-24	12.74
3/8	16	HRDL024-16	14.20
3/8	24	HRDL024-24	14.20
7/16	14	HRDL028-14	16.60
7/16	20	HRDL028-20	16.60
1/2	13	HRDL032-13	19.46
1/2	20	HRDL032-20	19.46
9/16	12	HRDL036-12	22.88

DIA. ACROSS FLATS		ITEM NO.	PRICE
SIZE	TPI		
9/16	18	HRDL036-18	22.88
5/8	11	HRDL040-11	26.60
5/8	18	HRDL040-18	26.60
11/16	11	HRDL044-11	31.50
11/16	16	HRDL044-16	31.50
3/4	10	HRDL048-10	33.70
3/4	16	HRDL048-16	33.70
7/8	9	HRDL056-09	39.10
7/8	14	HRDL056-14	39.10
1	8	HRDL100-08	49.54
1	12	HRDL100-12	49.54

DIA. ACROSS FLATS		ITEM NO.	PRICE
SIZE	TPI		
1	14	HRDL100-14	49.54
1-1/8	7	HRDL108-07	67.72
1-1/8	12	HRDL108-12	67.72
1-1/4	7	HRDL116-07	77.72
1-1/4	12	HRDL116-12	77.72
1-3/8	6	HRDL124-06	102.48
1-3/8	12	HRDL124-12	102.48
1-1/2	6	HRDL132-06	111.46
1-1/2	12	HRDL132-12	111.46
1-3/4	5	HRDL148-05	207.40
2	4-1/2	HRDL200-04.5	254.44

HEXAGON RETHREADING PIPE (NPT) DIES

ICS WIS

GENERAL PURPOSE

CUT THREAD

Hexagon (Hex Nut Diameter) NPT Rethreading Pipe Dies are designed extra thick for rethreading damaged or jammed taper pipe threads. NPT die threads taper 3/4" per foot and all of the threads on these dies do the rethreading as compared to NPS straight threads where only non-chamfered do the rethreading.

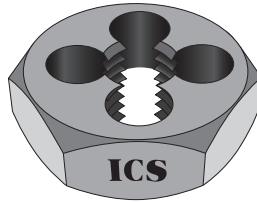

HEX NUT DIA.
ACROSS FLATS

RIGHT HAND
CUT

SIZE	TPI	DIA. ACROSS FLATS	ITEM NO.	PRICE
1/16	27	25/32	HRDP004-27	14.90
1/8	27	25/32	HRDP008-27	14.90
1/4	18	1-1/16	HRDP016-18	19.90
3/8	18	1-1/4	HRDP024-18	26.90
1/2	14	1-5/8	HRDP032-14	28.54
3/4	14	1-13/16	HRDP048-14	43.74

SIZE	TPI	DIA. ACROSS FLATS	ITEM NO.	PRICE
1	11-1/2	2-3/16	HRDP100-11.5	73.94
1-1/4	11-1/2	3-1/8	HRDP116-11.5	111.44
1-1/2	11-1/2	3-1/8	HRDP132-11.5	184.54
2	11-1/2	3-3/4	HRDP200-11.5	241.50
2-1/2	8	5	HRDP232-08	338.48
3	8	6	HRDP300-08	CALL

HEXAGON RETHREADING PIPE (NPS) DIES

ICS WIS

GENERAL PURPOSE

CUT THREAD

Hexagon (Hex Nut Diameter) NPS Rethreading Pipe Dies are designed extra thick for rethreading damaged or jammed external straight pipe threads. They are not intended for producing new threads.

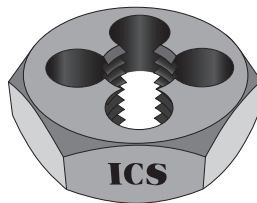

HEX NUT DIA.
ACROSS FLATS

RIGHT HAND
CUT

SIZE	TPI	DIA. ACROSS FLATS	ITEM NO.	PRICE
1/16	27	25/32	HRDPS004-27	CALL FOR PRICE
1/8	27	25/32	HRDPS008-27	
1/4	18	1-1/16	HRDPS016-18	
3/8	18	1-1/4	HRDPS024-18	
1/2	14	1-5/8	HRDPS032-14	
3/4	14	1-13/16	HRDPS048-14	

SIZE	TPI	DIA. ACROSS FLATS	ITEM NO.	PRICE
1	11-1/2	2-3/16	HRDPS100-11.5	CALL FOR PRICE
1-1/4	11-1/2	3-1/8	HRDPS116-11.5	
1-1/2	11-1/2	3-1/8	HRDPS132-11.5	
2	11-1/2	3-3/4	HRDPS200-11.5	
2-1/2	8	5	HRDPS232-08	
3	8	6	HRDPS300-08	

HEXAGON (SPECIAL THREAD) RETHREADING DIES

ICS WIS

SPECIAL PURPOSE

CUT THREAD

Tool Steel Special Thread Hexagon Rethreading Dies are designed for rethreading damaged or jammed non-standard threaded studs, bolts or rod. They are extra thick for more strength and are more durable than carbon steel hex rethreading dies and can be used to work in places where round die stocks cannot be used. They are not intended to cut new threads. All sizes are manufactured to be the same as a hex nut of equal thread size and can be used with any socket, open end, box, monkey, or adjustable wrench.

HEX NUT DIA.
ACROSS FLATS

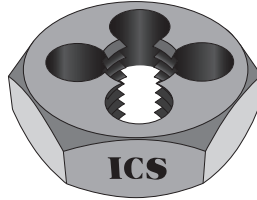

RIGHT HAND
CUT

DIA. ACROSS FLATS		ITEM NO.	PRICE
SIZE	TPI		
1/4	24	HRDS016-24	9.74
1/4	27	HRDS016-27	9.74
1/4	32	HRDS016-32	9.74
1/4	36	HRDS016-36	11.90
1/4	40	HRDS016-40	11.90
1/4	48	HRDS016-48	11.90
5/16	16	HRDS020-16	10.90
5/16	20	HRDS020-20	10.90
5/16	27	HRDS020-27	10.90
5/16	32	HRDS020-32	10.90
5/16	40	HRDS020-40	11.90
3/8	18	HRDS024-18	12.46
3/8	20	HRDS024-20	12.46
3/8	27	HRDS024-27	12.46
3/8	32	HRDS024-32	12.46
3/8	40	HRDS024-40	15.80
7/16	24	HRDS028-24	14.10
7/16	28	HRDS028-28	14.10
7/16	32	HRDS028-32	14.10
7/16	40	HRDS028-40	17.22
1/2	16	HRDS032-16	18.24
1/2	18	HRDS032-18	18.24
1/2	20	HRDS032-20	18.24
1/2	24	HRDS032-24	16.60
1/2	28	HRDS032-28	16.60
1/2	32	HRDS032-32	16.60
9/16	16	HRDS032-16	21.46
9/16	32	HRDS036-32	21.46
9/16	20	HRDS036-20	19.40
9/16	24	HRDS036-24	19.40
5/8	16	HRDS040-16	22.68
5/8	32	HRDS040-32	22.68
5/8	20	HRDS040-20	20.58
5/8	24	HRDS040-24	20.58
11/16	18	HRDS044-18	28.78
11/16	20	HRDS044-20	28.78
11/16	24	HRDS044-24	28.78
3/4	18	HRDS048-18	28.78
3/4	32	HRDS048-32	28.78
3/4	20	HRDS048-20	26.24
3/4	24	HRDS048-24	26.24
13/16	16	HRDS052-16	33.38
13/16	20	HRDS052-20	33.38
13/16	24	HRDS052-24	33.38
13/16	32	HRDS052-32	33.38
7/8	16	HRDS056-16	33.38
7/8	32	HRDS056-32	33.38
7/8	40	HRDS056-40	33.38
7/8	18	HRDS056-18	30.32
7/8	20	HRDS056-20	30.32
7/8	24	HRDS056-24	30.32
15/16	14	HRDS060-14	42.22
15/16	16	HRDS060-16	42.22
15/16	18	HRDS060-18	42.22
15/16	20	HRDS060-20	42.22
1	10	HRDS100-10	38.36
1	16	HRDS100-16	38.36
1	18	HRDS100-18	38.36
1	20	HRDS100-20	38.36
1	24	HRDS100-24	38.36
1	32	HRDS100-32	42.22
1-1/16	8	HRDS104-08	57.88
1-1/16	16	HRDS104-16	57.88
1-1/16	18	HRDS104-18	57.88
1-1/16	12	HRDS104-12	52.66
1-1/8	8	HRDS108-08	52.66
1-1/8	16	HRDS108-16	57.88

DIA. ACROSS FLATS		ITEM NO.	PRICE
SIZE	TPI		
1-1/8	8	HRDS108-08	57.88
1-1/8	10	HRDS108-10	57.88
1-3/16	8	HRDS112-08	60.70
1-3/16	10	HRDS112-10	60.70
1-3/16	18	HRDS112-18	60.70
1-3/16	12	HRDS112-12	66.74
1-1/4	5	HRDS116-05	60.70
1-1/4	10	HRDS116-10	60.70
1-1/4	8	HRDS116-08	66.74
1-1/4	16	HRDS116-16	66.74
1-1/4	18	HRDS116-18	66.74
1-1/4	20	HRDS116-20	66.74
1-5/16	8	HRDS120-08	78.28
1-5/16	12	HRDS120-12	78.28
1-5/16	18	HRDS120-18	86.10
1-3/8	7	HRDS124-07	86.10
1-3/8	10	HRDS124-10	86.10
1-3/8	16	HRDS124-16	86.10
1-3/8	18	HRDS124-18	86.10
1-3/8	20	HRDS124-20	86.10
1-3/8	8	HRDS124-08	78.28
1-7/16	6	HRDS128-06	95.80
1-7/16	8	HRDS128-08	95.80
1-7/16	12	HRDS128-12	95.80
1-7/16	16	HRDS128-16	95.80
1-7/16	18	HRDS128-18	95.80
1-1/2	8	HRDS132-08	87.10
1-1/2	14	HRDS132-14	95.80
1-1/2	16	HRDS132-16	95.80
1-1/2	18	HRDS132-18	95.80
1-1/2	20	HRDS132-20	95.80
1-9/16	12	HRDS136-12	132.26
1-9/16	16	HRDS136-16	132.26
1-9/16	18	HRDS136-18	132.26
1-5/8	4	HRDS140-04	132.26
1-5/8	14	HRDS140-14	132.26
1-5/8	16	HRDS140-16	132.26
1-5/8	18	HRDS140-18	132.26
1-5/8	5	HRDS140-05	120.22
1-5/8	6	HRDS140-06	120.22
1-5/8	8	HRDS140-08	120.22
1-5/8	10	HRDS140-10	120.22
1-11/16	18	HRDS144-18	182.94
1-3/4	5-1/2	HRDS148-05.5	165.36
1-3/4	6	HRDS148-06	165.36
1-3/4	10	HRDS148-10	165.36
1-3/4	12	HRDS148-12	165.36
1-3/4	14	HRDS148-14	165.36
1-3/4	16	HRDS148-16	165.36
1-3/4	18	HRDS148-18	165.36
1-3/4	20	HRDS148-20	165.36
1-3/4	8	HRDS148-08	150.30
1-13/16	12	HRDS152-12	210.44
1-13/16	18	HRDS152-18	210.44
1-7/8	8	HRDS156-08	176.84
1-7/8	12	HRDS156-12	176.84
1-7/8	16	HRDS156-16	194.52
1-7/8	18	HRDS156-18	194.52
2	4	HRDS200-04	218.16
2	8	HRDS200-08	218.16
2	10	HRDS200-10	218.16
2	12	HRDS200-12	218.16
2	14	HRDS200-14	234.38
2	16	HRDS200-16	234.38
2	18	HRDS200-18	234.38
2	20	HRDS200-20	234.38
2	24	HRDS200-24	234.38

DIA. ACROSS FLATS		ITEM NO.	PRICE
SIZE	TPI		
2-1/8	6	HRDS208-06	219.68
2-1/8	14	HRDS208-14	219.68
2-1/8	16	HRDS208-16	219.68
2-1/8	18	HRDS208-18	219.68
2-1/8	8	HRDS208-08	223.70
2-1/8	12	HRDS208-12	223.70
2-1/4	6	HRDS216-06	246.06
2-1/4	10	HRDS216-10	246.06
2-1/4	14	HRDS216-14	246.06
2-1/4	16	HRDS216-16	246.06
2-1/4	18	HRDS216-18	246.06
2-1/4	4	HRDS216-04	223.70
2-1/4	8	HRDS216-08	223.70
2-1/4	12	HRDS216-12	223.70
2-3/8	4	HRDS224-04	309.56
2-3/8	8	HRDS224-08	309.56
2-3/8	12	HRDS224-12	309.56
2-3/8	10	HRDS224-10	340.52
2-3/8	14	HRDS224-14	340.52
2-3/8	18	HRDS224-18	340.52
2-1/2	4-1/2	HRDS232-04.5	340.52
2-1/2	5	HRDS232-05	340.52
2-1/2	6	HRDS232-06	340.52
2-1/2	10	HRDS232-10	340.52
2-1/2	16	HRDS232-16	340.52
2-1/2	18	HRDS232-18	340.52
2-1/2	8	HRDS232-08	309.56
2-1/2	12	HRDS232-12	309.56
2-5/8	6	HRDS240-06	403.80
2-5/8	14	HRDS240-14	403.80
2-5/8	16	HRDS240-16	403.80
2-5/8	8	HRDS240-08	367.16
2-5/8	12	HRDS240-12	367.16
2-3/4	6	HRDS248-06	403.80
2-3/4	10	HRDS248-10	403.80
2-3/4	14	HRDS248-14	403.80
2-3/4	18	HRDS248-18	403.80
2-3/4	8	HRDS248-08	367.16
2-3/4	12	HRDS248-12	367.16
2-7/8	6	HRDS256-06	507.98
2-7/8	8	HRDS256-08	507.98
2-7/8	12	HRDS256-12	461.88
3	8	HRDS300-08	461.88
3	12	HRDS300-12	461.88
3-1/8	4	HRDS308-04	528.30
3-1/8	8	HRDS308-08	528.30
3-1/8	12	HRDS308-12	528.30
3-1/4	5	HRDS316-05	528.30
3-1/4	12	HRDS316-12	528.30
3-1/4	8	HRDS316-08	581.18
3-3/8	4	HRDS324-04	528.30
3-3/8	8	HRDS324-08	528.30
3-3/8	12	HRDS324-12	528.30
3-1/2	8	HRDS332-08	528.30
3-1/2	12	HRDS332-12	528.30
3-5/8	4	HRDS340-04	608.00
3-5/8	8	HRDS340-08	608.00
3-5/8	12	HRDS340-12	608.00
3-3/4	8	HRDS348-08	608.00
3-3/4	12	HRDS348-12	608.00
3-7/8	4	HRDS356-04	692.82
3-7/8	8	HRDS356-08	692.82
3-7/8	12	HRDS356-12	765.76
4	8	HRDS400-08	692.82
4	12	HRDS400-12	694.00

METRIC HEXAGON RETHREADING DIES

ICS WIS

GENERAL PURPOSE

CUT THREAD

HEX NUT DIA.
ACROSS FLATS

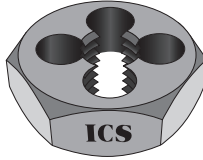

RIGHT HAND
CUT

SIZE	DIA. ACROSS		ITEM NO.	PRICE
	PITCH	FLATS		
M3	.50	19/32	HRDM03.0X.50	9.78
M3	.60	19/32	HRDM03.0X.60	9.78
M3.5	.60	19/32	HRDM03.5X.60	9.78
M4	.70	19/32	HRDM04.0X.70	9.78
M4	.75	19/32	HRDM04.0X.75	9.78
M4.5	.75	19/32	HRDM04.5X.75	9.78
M5	.80	19/32	HRDM05.0X.80	9.78
M5	.90	19/32	HRDM05.0X.90	9.78
M6	1.00	19/32	HRDM06.0X1.0	9.78
M6.3	1.00	19/32	HRDM06.3X1.0	10.00
M7	1.00	11/16	HRDM07.0X1.0	10.48
M8	1.00	11/16	HRDM08.0X1.0	10.48
M8	1.25	11/16	HRDM08.0X1.25	10.48
M9	1.00	25/32	HRDM09.0X1.0	15.28

SIZE	DIA. ACROSS		ITEM NO.	PRICE
	PITCH	FLATS		
M9	1.25	25/32	HRDM08.0X1.25	15.28
M10	1.25	7/8	HRDM10.0X1.25	14.84
M10	1.50	7/8	HRDM10.0X1.5	14.84
M11	1.50	7/8	HRDM11.0X1.5	17.84
M12	1.25	1-1/16	HRDM12.0X1.25	17.06
M12	1.75	1-1/16	HRDM12.0X1.75	17.06
M14	1.50	1-1/16	HRDM14.0X1.5	20.48
M14	2.00	1-1/16	HRDM14.0X2.0	20.48
M16	1.50	1-1/4	HRDM16.0X1.5	22.48
M16	2.00	1-1/4	HRDM16.0X2.0	22.48
M18	1.50	1-7/16	HRDM18.0X1.5	26.24
M18	2.50	1-7/16	HRDM18.0X2.5	26.24
M20	1.50	1-5/8	HRDM20.0X1.5	28.86
M20	2.50	1-5/8	HRDM20.0X2.5	28.86

SIZE	DIA. ACROSS		ITEM NO.	PRICE
	PITCH	FLATS		
M22	1.50	1-5/8	HRDM22.0X1.5	33.48
M22	2.50	1-5/8	HRDM22.0X2.5	33.48
M24	2.00	1-13/16	HRDM24.0X2.0	34.78
M24	3.00	1-13/16	HRDM24.0X3.0	34.78
M27	2.00	2	HRDM27.0X2.0	53.56
M27	3.00	2	HRDM27.0X3.0	53.56
M30	2.00	2-3/16	HRDM30.0X2.0	53.56
M30	3.50	2-3/16	HRDM30.0X3.5	53.56
M33	2.00	2-3/8	HRDM33.0X2.0	61.46
M33	3.50	2-3/8	HRDM33.0X3.5	61.46
M36	3.00	2-9/16	HRDM36.0X3.0	98.02
M36	4.00	2-9/16	HRDM36.0X4.0	87.28
M39	3.00	3-1/8	HRDM39.0X3.0	92.26
M39	4.00	3-1/8	HRDM39.0X4.0	92.26

SPECIAL THREAD SIZES

SIZE	DIA. ACROSS		ITEM NO.	PRICE
	PITCH	FLATS		
M3	.35	19/32	HRDM03.0X.35	11.24
M3.5	.50	19/32	HRDM03.5X.50	11.24
M4	.50	19/32	HRDM04.0X.50	11.24
M4.5	.50	19/32	HRDM04.5X.50	11.24
M5	.50	19/32	HRDM05.0X.50	11.24
M5	.75	19/32	HRDM05.0X.75	11.24
M5.5	.80	19/32	HRDM05.5X.80	11.24
M5.5	.90	19/32	HRDM05.5X.90	11.24
M6	.50	19/32	HRDM06.0X.50	11.24
M6	.75	19/32	HRDM06.0X.75	11.24
M7	.50	11/16	HRDM07.0X.50	12.60
M7	.75	11/16	HRDM07.0X.75	12.60
M8	.50	11/16	HRDM08.0X.50	12.60
M8	.75	11/16	HRDM08.0X.75	12.60
M9	.50	25/32	HRDM09.0X.50	13.86
M9	.75	25/32	HRDM09.0X.75	13.86
M10	.50	7/8	HRDM10.0X.50	16.24
M10	.75	7/8	HRDM10.0X.75	16.24
M10	1.00	7/8	HRDM10.0X1.0	16.24
M11	.50	7/8	HRDM11.0X.50	16.24
M11	.75	7/8	HRDM11.0X.75	16.24
M11	1.00	7/8	HRDM11.0X1.0	16.24
M11	1.25	7/8	HRDM11.0X1.25	16.24
M12	.50	1-1/16	HRDM12.0X.50	17.06
M12	.75	1-1/16	HRDM12.0X.75	17.06
M12	1.00	1-1/16	HRDM12.0X1.0	17.06
M12	1.50	1-1/16	HRDM12.0X1.5	17.06
M13	.50	1-1/16	HRDM13.0X.50	18.82
M13	.75	1-1/16	HRDM13.0X.75	18.82
M13	1.00	1-1/16	HRDM13.0X1.0	18.82
M13	1.25	1-1/16	HRDM13.0X1.25	18.82
M13	1.50	1-1/16	HRDM13.0X1.5	18.82
M13	2.00	1-1/16	HRDM13.0X2.0	18.82
M14	.50	1-1/16	HRDM14.0X.50	20.48
M14	.75	1-1/16	HRDM14.0X.75	20.48
M14	1.00	1-1/16	HRDM14.0X1.0	20.48

SIZE	DIA. ACROSS		ITEM NO.	PRICE
	PITCH	FLATS		
M14	1.25	1-1/16	HRDM14.0X1.25	20.48
M15	.50	1-1/4	HRDM15.0X.50	22.02
M15	1.00	1-1/4	HRDM15.0X1.0	22.02
M15	1.50	1-1/4	HRDM15.0X1.5	22.02
M15	2.00	1-1/4	HRDM15.0X2.0	22.02
M16	.50	1-1/4	HRDM16.0X.50	23.24
M16	.75	1-1/4	HRDM16.0X.75	23.24
M16	1.00	1-1/4	HRDM16.0X1.0	23.24
M16	1.25	1-1/4	HRDM16.0X1.25	23.24
M17	.50	1-7/16	HRDM17.0X.50	28.92
M17	1.00	1-7/16	HRDM17.0X1.0	28.92
M17	1.50	1-7/16	HRDM17.0X1.5	28.92
M17	2.00	1-7/16	HRDM17.0X2.0	28.92
M18	.50	1-7/16	HRDM18.0X.50	32.38
M18	1.00	1-7/16	HRDM18.0X1.0	32.38
M18	2.00	1-7/16	HRDM18.0X2.0	32.38
M19	.50	1-7/16	HRDM19.0X.50	33.06
M19	1.00	1-7/16	HRDM19.0X1.0	33.06
M19	1.50	1-7/16	HRDM19.0X1.5	33.06
M19	2.00	1-7/16	HRDM19.0X2.0	33.06
M20	1.00	1-5/8	HRDM20.0X1.0	33.06
M20	1.25	1-5/8	HRDM20.0X1.25	33.06
M20	2.00	1-5/8	HRDM20.0X2.0	33.06
M21	1.00	1-5/8	HRDM21.0X1.0	33.06
M21	1.50	1-5/8	HRDM21.0X1.5	33.06
M21	2.00	1-5/8	HRDM21.0X2.0	33.06
M21	2.50	1-5/8	HRDM21.0X2.5	33.06
M22	1.00	1-5/8	HRDM22.0X1.0	35.14
M22	2.00	1-5/8	HRDM22.0X2.0	35.14
M22	3.00	1-5/8	HRDM22.0X3.0	35.14
M23	1.00	1-13/16	HRDM23.0X1.0	35.14
M23	1.50	1-13/16	HRDM23.0X1.5	35.14
M23	2.00	1-13/16	HRDM23.0X2.0	35.14
M23	2.50	1-13/16	HRDM23.0X2.5	35.14
M24	1.00	1-13/16	HRDM24.0X1.0	43.90

SIZE	DIA. ACROSS		ITEM NO.	PRICE
	PITCH	FLATS		
M24	1.50	1-13/16	HRDM24.0X1.5	43.90
M24	2.50	1-13/16	HRDM24.0X2.5	43.90
M25	1.00	1-13/16	HRDM25.0X1.0	43.90
M25	1.50	1-13/16	HRDM25.0X1.5	43.90
M25	2.00	1-13/16	HRDM25.0X2.0	43.90
M26	1.50	2	HRDM26.0X1.5	43.90
M26	2.00	2	HRDM26.0X2.0	43.90
M27	1.00	2	HRDM27.0X1.0	58.32
M27	1.50	2	HRDM27.0X1.5	58.32
M28	1.50	2	HRDM28.0X1.5	62.48
M28	2.00	2	HRDM28.0X2.0	62.48
M30	1.00	2-3/16	HRDM30.0X1.0	66.16
M30	1.50	2-3/16	HRDM30.0X1.5	66.16
M30	3.00	2-3/16	HRDM30.0X3.0	82.70
M32	1.50	2-3/16	HRDM32.0X1.5	75.12
M33	1.50	2-3/8	HRDM33.0X1.5	69.54
M34	1.50	2-3/8	HRDM34.0X1.5	82.78
M35	1.50	2-3/8	HRDM35.0X1.5	92.64
M36	1.50	2-9/16	HRDM36.0X1.5	92.26
M38	1.50	2-9/16	HRDM38.0X1.5	92.26
M39	1.50	3-1/8	HRDM39.0X1.5	92.26
M40	1.50	3-1/8	HRDM40.0X1.5	156.32
M42	1.50	3-1/8	HRDM42.0X1.5	177.08
M42	3.00	3-1/8	HRDM42.0X3.0	177.08
M42	4.50	3-1/8	HRDM42.0X4.5	177.08
M45	1.50	3-1/8	HRDM45.0X1.5	177.08
M45	3.00	3-1/8	HRDM45.0X3.0	177.08
M45	4.50	3-1/8	HRDM45.0X4.5	177.08
M48	1.50	3-1/8	HRDM48.0X1.5	220.68
M48	3.00	3-1/8	HRDM48.0X3.0	220.68
M48	5.00	3-1/8	HRDM48.0X5.0	220.68
M50	1.50	3-1/2	HRDM50.0X1.5	220.68
M52	1.50	3-1/2	HRDM52.0X1.5	239.70
M52	3.00	3-1/2	HRDM52.0X3.0	239.70
M52	5.00	3-1/2	HRDM52.0X5.0	239.70

LEFT HAND SIZES

SIZE	DIA. ACROSS		ITEM NO.	PRICE
	PITCH	FLATS		
M5	.80	19/32	HRDML05.0X0.80	12.38
M6	1.00	19/32	HRDML0.60X1.00	12.38
M7	1.00	11/16	HRDML0.70X1.00	13.94
M8	1.25	11/16	HRDML0.80X1.25	13.94
M10	1.25	7/8	HRDML10.0X1.25	15.34
M10	1.50	7/8	HRDML10.0X1.50	15.34

SIZE	DIA. ACROSS		ITEM NO.	PRICE
	PITCH	FLATS		
M12	1.25	1-1/16	HRDML12.0X1.25	17.24
M12	1.75	1-1/16	HRDML12.0X1.75	17.24
M16	1.50	1-1/4	HRDML16.0X1.50	23.46
M16	2.00	1-1/4	HRDML16.0X2.00	23.46
M18	1.50	1-7/16	HRDML18.0X1.50	26.84
M18	2.50	1-7/16	HRDML18.0X2.50	26.84

SIZE	DIA. ACROSS		ITEM NO.	PRICE
	PITCH	FLATS		
M20	1.50	1-5/8	HRDML20.0X1.50	33.00
M20	2.50	1-5/8	HRDML20.0X2.50	33.00
M24	1.50	1-13/16	HRDML24.0X1.50	48.84
M24	2.00	1-13/16	HRDML24.0X2.00	49.14
M24	3.00	1-13/16	HRDML24.0X3.00	49.14

TOOL STEEL HEXAGON RETHREADING DIE SETS

WOODEN CASES

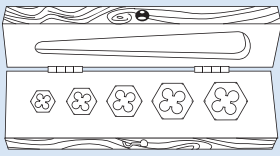
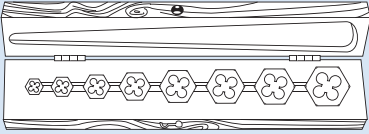
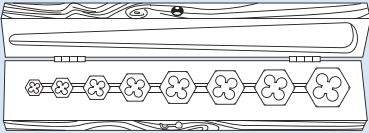
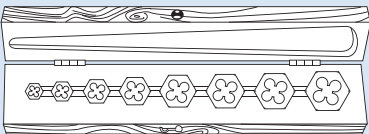
ILLUSTRATION	DESCRIPTION	CUT	THREAD TYPE	ITEM NO.	PRICE
5 PC HEX DIE SET  SIZES: 1/4 to 1/2 or M6 to M14	5 PC Hex Die Set in a hinged wooden case. Contents of NC, NF, and Metric sets are listed below. (Specify style required.)	Right Hand	Coarse	DS-HRD-5C	84.80
		Right Hand	Fine	DS-HRD-5F	84.80
		Left Hand	Coarse	DS-HRDL-5C	103.16
		Left Hand	Fine	DS-HRDL-5F	103.16
		Right Hand	Metric	DS-HRDM-5C	106.66
SIZES OF DIES IN 5 PC SET					
	NC (Coarse) 1/4-20, 5/16-18, 3/8-16, 7/16-14, 1/2-13				
	NF (Fine) 1/4-28, 5/16-24, 3/8-24, 7/16-20, 1/2-20				
	M (Metric) M6.0 x 1.0, M8.0 x 1.25, M10.0 x 1.5, M12.0 x 1.75, M14.0 x 2.0				
8 PC HEX DIE SET  SIZES: 1/4 to 3/4 or M6 to M20	8 PC Hex Die Set in a hinged wooden case. Contents of NC, NF, and Metric sets are listed below. (Specify style required.)	Right Hand	Coarse	DS-HRD-8C	127.74
		Right Hand	Fine	DS-HRD-8F	127.74
		Left Hand	Coarse	DS-HRDL-8C	163.20
		Left Hand	Fine	DS-HRDL-8F	163.20
		Right Hand	Metric	DS-HRDM-8C	172.08
SIZES OF DIES IN 8 PC SET					
	NC (Coarse) 1/4-20, 5/16-18, 3/8-16, 7/16-14, 1/2-13, 9/16-12, 5/8-11, 3/4-10				
	NF (Fine) 1/4-28, 5/16-24, 3/8-24, 7/16-20, 1/2-20, 9/16-18, 5/8-18, 3/4-16				
	M (Metric) M6.0 x 1.0, M8.0 x 1.25, M10.0 x 1.5, M12.0 x 1.75, M14.0 x 2.0, M16.0 x 2.0, M18.0 x 2.5, M20.0 x 2.5				
10 PC HEX DIE SET  SIZES: 1/4 to 1 or M6 to M24	10 PC Hex Die Set in a hinged wooden case. Contents of NC, NF, and Metric sets are listed below. (Specify style required.)	Right Hand	Coarse	DS-HRD-10C	121.12
		Right Hand	Fine	DS-HRD-10F	121.12
		Left Hand	Coarse	DS-HRDL-10C	243.74
		Left Hand	Fine	DS-HRDL-10F	243.74
		Right Hand	Metric	DS-HRDM-10C	241.42
SIZES OF DIES IN 10 PC SET					
	NC (Coarse) 1/4-20, 5/16-18, 3/8-16, 7/16-14, 1/2-13, 9/16-12, 5/8-11, 3/4-10, 7/8-9, 1-8				
	NF (Fine) 1/4-28, 5/16-24, 3/8-24, 7/16-20, 1/2-20, 9/16-18, 5/8-18, 3/4-16, 7/8-14, 1-14				
	M (Metric) M6.0 x 1.0, M8.0 x 1.25, M10.0 x 1.5, M12.0 x 1.75, M14.0 x 2.0, M16.0 x 2.0, M18.0 x 2.5, M20.0 x 2.5, M22.0 x 2.5, M24.0 x 3.0				
4 PC HEX DIE SET  SIZES: 1-1/8 to 1-1/2 or M27 to M36	4 PC Hex Die Set in a hinged wooden case. Contents of NC, NF, and Metric sets are listed below. (Specify style required.)	Right Hand	Coarse	DS-HRD-4C	140.70
		Right Hand	Fine	DS-HRD-4F	140.70
		Left Hand	Coarse	DS-HRDL-4C	319.48
		Left Hand	Fine	DS-HRDL-4F	319.48
		Right Hand	Metric	DS-HRDM-4C	233.76
SIZES OF DIES IN 4 PC SET					
	NC (Coarse) 1-1/8-7, 1-1/4-7, 1-3/8-6, 1-1/2-6				
	NF (Fine) 1-1/8-12, 1-1/4-12, 1-3/8-12, 1-1/2-12				
	M (Metric) M27.0 x 3.0, M30.0 x 3.5, M33.0 x 3.5, M36.0 x 4.0				

HEXAGON RETHREADING PIPE DIE SET

PLASTIC CASE

ILLUSTRATION	DESCRIPTION	CUT	THREAD TYPE	ITEM NO.	PRICE
	6 PC Hex Pipe NPT Dies in a hinged wooden case. Contents of NPT set is listed below. wt. 5lbs.	Taper	Regular	DS-HRDP-6	168.00
		SIZES OF DIES IN 6 PC SET			
	NPT (Regular Taper) 1/8-27, 1/4-18, 3/8-18, 1/2-14, 3/4-14, 1-11-1/2				

12 PC PIPE TAP AND HEXAGON DIE SETS

PLASTIC CASE

12 Piece High Speed/Carbon Steel NPT Pipe Tap & Hex Die Sets are designed to repair damaged NPT pipe threads. Sets come in a deluxe black plastic carrying case. Each 12 piece set contains one NPT Pipe Tap and NPT Hex Die in the following sizes: 1/8 - 27, 1/4 - 18, 3/8 - 18, 1/2 - 14, 3/4 - 14, and 1 - 11-1/2.

ILLUSTRATION	DESCRIPTION	CUT	ITEM NO.	PRICE
<p data-bbox="155 369 459 426">12 PC NPT PIPE TAP & HEX DIE SET</p>  <p data-bbox="217 1073 396 1100">Sizes: 1/8" - 1"</p>	<p data-bbox="553 369 889 573">Each set contains one each NPT Pipe Tap & Hex Die in your choice of either carbon steel, high speed steel or a combination of high speed steel taps and carbon steel hex dies.</p>	Right Hand	THDS-CS-12NPT Carbon Steel Taps/Dies	207.90
		Right Hand	THDS-HS-12NPT HSS Taps/Dies	563.80
		Right Hand	THDS-HSC-12NPT HSS Taps Carbon Steel Dies	380.10
SIZES OF NPT PIPE TAPS & HEX DIES				
1/8 - 27, 1/4 - 18, 3/8 - 18, 1/2 - 14, 3/4 - 14, 1 - 11-1/2				

Note: Carbon Steel Taps are for rethreading only. HSS taps and dies can be used for rethreading and cutting new threads with taps.

CARBON STEEL HEXAGON RETHREADING DIES

ICS USA

GENERAL PURPOSE

CUT THREAD

Hexagon (Standard Diameter) Rethreading Dies are designed for rethreading damaged or jammed threads and can be used to work in places where round die stocks can not be used. They are not intended for producing new threads on unthreaded bars, bolts, or pipes. They will perform all of the same tasks as (HRD) Hex Rethreading Dies. All sizes are manufactured using three standard hex stock diameters to reduce costs and simplify die stock or wrench requirements.

MACHINE SCREW AND FRACTIONAL SIZES

METRIC SIZES



SIZE	TPI	DIA.		ITEM NO.	PRICE
		ACROSS FLATS			
4	40	1		HXD#04-40	3.36
6	32	1		HXD#06-32	3.36
8	32	1		HXD#08-32	3.36
10	24	1		HXD#10-24	3.36
10	32	1		HXD#10-32	3.36
12	24	1		HXD#12-24	3.36
14	20	1		HXD016-20	3.36
3/16	24	1		HXD012-24	3.36
3/16	32	1		HXD012-32	3.36
1/4	20	1		HXD016-20	3.36
1/4	28	1		HXD016-28	3.36
5/16	18	1		HXD020-18	3.36
5/16	24	1		HXD020-24	3.36
3/8	16	1		HXD024-16	3.36
3/8	24	1		HXD024-24	3.36
7/16	14	1		HXD028-14	3.36
7/16	20	1		HXD028-20	3.36
1/2	13	1		HXD032-13	3.36
1/2	20	1		HXD032-20	3.36
9/16	12	1-7/16		HXD036-12	8.46
9/16	18	1-7/16		HXD036-18	8.46
5/8	11	1-7/16		HXD040-11	8.46
5/8	18	1-7/16		HXD040-18	8.46
3/4	10	1-7/16		HXD048-10	8.46
3/4	16	1-7/16		HXD048-16	8.46
7/8	9	1-7/8		HXD056-09	17.16
7/8	14	1-7/8		HXD056-14	17.16
1	8	1-7/8		HXD100-08	17.16
1	12	1-7/8		HXD100-12	17.16
1	14	1-7/8		HXD100-14	17.16

SIZE	TPI	DIA.		ITEM NO.	PRICE
		ACROSS FLATS			
M3	.50	1		HXDM03.0X.50	3.84
M3	.60	1		HXDM03.0X.60	3.84
M4	.70	1		HXDM04.0X.70	3.84
M4	.75	1		HXDM04.0X.75	3.84
M5	.80	1		HXDM05.0X.80	3.84
M5	.90	1		HXDM05.0X.90	3.84
M6	1.00	1		HXDM06.0X1.00	3.84
M7	1.00	1		HXDM07.0X1.00	3.84
M8	1.25	1		HXDM08.0X1.25	3.84
M9	1.00	1		HXDM09.0X1.00	3.84
M9	1.25	1		HXDM09.0X1.25	3.84
M10	1.25	1		HXDM10.0X1.25	3.84
M10	1.50	1		HXDM10.0X1.50	3.84
M11	1.50	1		HXDM11.0X1.55	3.84
M12	1.50	1		HXDM12.0X1.50	3.84
M12	1.75	1		HXDM12.0X1.75	3.84
M14	1.25	1-7/16		HXDM14.0X1.25	9.54
M16	2.00	1-7/16		HXDM16.0X2.00	9.54
M18	1.50	1-7/16		HXDM18.0X1.50	9.54
M18	2.50	1-7/16		HXDM18.0X2.50	9.54

Metric sizes in bold type are coarse thread form.

CARBON STEEL HEXAGON (BSPT) PIPE DIES

GENERAL PURPOSE



SIZE	TPI	DIA.		ITEM NO.	PRICE
		ACROSS FLATS			
1/8	28	1		HXDBP008-28	3.96
1/4	19	1		HXDBP016-19	3.96

CARBON STEEL HEXAGON (NPT) PIPE DIES

GENERAL PURPOSE



SIZE	TPI	DIA.		ITEM NO.	PRICE
		ACROSS FLATS			
1/8	27	1		HXDP008-27	3.54
1/4	18	1		HXDP016-18	11.86
3/8	18	1-7/8		HXDP024-18	17.04
1/2	14	1-7/8		HXDP032-14	17.04

HIGH SPEED STEEL HEXAGON THREADING DIES

TT-59

ICS USA

HEAVY DUTY

GROUND THREAD

HSS Hex Threading Dies are designed for tough cutting applications of all types of external threads. They are used for threading rods, bolts, and studs. Two standard diameters of Hex Dies simplify die stock handle requirements. ICS Hex Threading Dies have polished gold face and black surface treated threads for maximum performance.

**STANDARD DIA.
ACROSS FLATS**

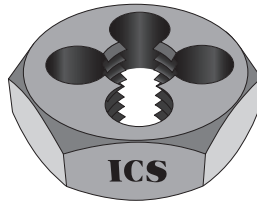

**RIGHT HAND
CUT**

BLACK & GOLD FINISH

Machine Screw and Fractional Sizes (#4 To 3/4" Dia.)

THREADS		DIAMETER		ITEM	
SIZE	PER INCH	ACROSS FLATS	NO.	PRICE	
4	40	1	HXTD#04-40	10.58	
6	32	1	HXTD#06-32	10.58	
8	32	1	HXTD#08-32	10.58	
10	24	1	HXTD#10-24	10.58	
10	32	1	HXTD#10-32	10.58	
12	24	1	HXTD#12-24	10.58	
1/4	20	1	HXTD016-20	10.58	
1/4	28	1	HXTD016-28	10.58	
5/16	18	1	HXTD020-18	10.58	
5/16	24	1	HXTD020-24	10.58	
3/8	16	1	HXTD024-16	10.58	
3/8	24	1	HXTD024-24	10.58	

THREADS		DIAMETER		ITEM	
SIZE	PER INCH	ACROSS FLATS	NO.	PRICE	
7/16	14	1	HXTD028-14	10.58	
7/16	20	1	HXTD028-20	10.58	
1/2	13	1	HXTD032-13	10.58	
1/2	20	1	HXTD032-20	10.58	
1/2	13	1-7/16	HXTD032-13A	23.66	
1/2	20	1-7/16	HXTD032-20A	23.66	
9/16	12	1-7/16	HXTD036-12	23.66	
9/16	18	1-7/16	HXTD036-18	23.66	
5/8	11	1-7/16	HXTD040-11	23.66	
5/8	18	1-7/16	HXTD040-18	23.66	
3/4	10	1-7/16	HXTD048-10	23.66	
3/4	16	1-7/16	HXTD048-16	23.66	

HIGH SPEED STEEL HEXAGON THREADING (NPT) PIPE DIES

ICS USA

HEAVY DUTY

GROUND THREAD

HSS Hexagon (Hex Nut Dia.) NPT Threading Pipe Dies are designed for external threading or rethreading of taper pipe threads. They are used where a threaded connection will not be required to withstand high fluid or gas pressures and the use of a sealer is acceptable.

**STANDARD DIA.
ACROSS FLATS**

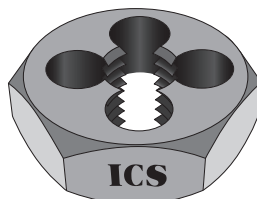

**RIGHT HAND
CUT**

BLACK & GOLD FINISH

THREADS		DIAMETER		ITEM	
SIZE	PER INCH	ACROSS FLATS	NO.	PRICE	
1/8	27	1	HXTDP008-27	10.58	

THREADS		DIAMETER		ITEM	
SIZE	PER INCH	ACROSS FLATS	NO.	PRICE	
1/4	18	1-7/16	HXTDP016-18A	23.66	

HIGH SPEED STEEL HEXAGON THREADING DIES

ICS WIS

HEAVY DUTY

GROUND THREAD

HSS Hexagon (Hex Nut Diameter) Threading Dies are designed for tough cutting applications of all types of external threads. They are used for threading rods, bolts, and studs. All sizes are manufactured to be the same size as a Hex Nut of equal thread size. ICS Hex Threading Dies have polished gold face and black surface treated threads for maximum performance.

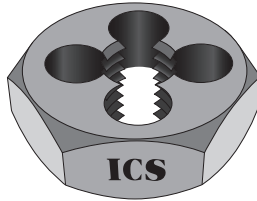

**HEX NUT DIA.
ACROSS FLATS**

**RIGHT HAND
CUT**

BLACK & GOLD FINISH

SIZE	THREADS PER INCH	DIAMETER ACROSS FLATS	ITEM NO.	PRICE
4	40	19/32	HTD#04-40	15.76
6	32	19/32	HTD#06-32	15.76
8	32	19/32	HTD#08-32	15.76
10	24	19/32	HTD#10-24	15.76
10	32	19/32	HTD#10-32	15.76
12	24	19/32	HTD#12-24	15.76
1/4	20	19/32	HTD016-20	15.76
1/4	28	19/32	HTD016-28	15.76
5/16	18	11/16	HTD020-18	18.38
5/16	24	11/16	HTD020-24	18.38
3/8	16	25/32	HTD024-16	20.06
3/8	24	25/32	HTD024-24	20.06
7/16	14	7/8	HTD028-14	22.36
7/16	20	7/8	HTD028-20	22.36
1/2	13	1-1/16	HTD032-13	26.26
1/2	20	1-1/16	HTD032-20	26.26
9/16	12	1-1/16	HTD036-12	31.04
9/16	18	1-1/16	HTD036-18	31.04

SIZE	THREADS PER INCH	DIAMETER ACROSS FLATS	ITEM NO.	PRICE
5/8	11	1-1/4	HTD040-11	34.66
5/8	18	1-1/4	HTD040-18	34.66
11/16	11	1-7/16	HTD044-11	43.68
11/16	16	1-7/16	HTD044-16	43.68
3/4	10	1-7/16	HTD048-10	43.68
3/4	16	1-7/16	HTD048-16	43.68
7/8	9	1-5/8	HTD056-09	58.80
7/8	14	1-5/8	HTD056-14	58.80
1	8	1-13/16	HTD100-08	75.70
1	12	1-13/16	HTD100-12	75.70
1	14	1-13-16	HTD100-14	75.70
1-1/8	7	2	HTD108-07	93.76
1-1/8	12	2	HTD108-12	93.76
1-1/4	7	2-3/16	HTD116-07	109.20
1-1/4	12	2-3/16	HTD116-12	109.20
1-3/8	6	2-3/8	HTD124-06	127.58
1-3/8	12	2-3/8	HTD124-12	127.58
1-1/2	6	2-9/16	HTD132-06	165.38
1-1/2	12	2-9/16	HTD132-12	165.38

HIGH SPEED STEEL HEXAGON THREADING (NPT) PIPE DIES

ICS WIS

HEAVY DUTY

GROUND THREAD

HSS Hexagon (Hex Nut Dia.) NPT Threading Pipe Dies are designed for external threading or rethreading of taper pipe threads. They are used where a threaded connection will not be required to withstand high fluid or gas pressures and the use of a sealer is acceptable.

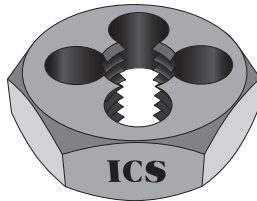

**HEX NUT DIA.
ACROSS FLATS**

**RIGHT HAND
CUT**

BLACK & GOLD FINISH

SIZE	THREADS PER INCH	DIAMETER ACROSS FLATS	ITEM NO.	PRICE
1/8	27	25/32	HTDP008-27	18.90
1/4	18	1-1/16	HTDP016-18	42.00
3/8	18	1-1/4	HTDP024-18	49.88
1/2	14	1-5/8	HTDP032-14	65.62
3/4	14	1-13/16	HTDP048-14	94.50

SIZE	THREADS PER INCH	DIAMETER ACROSS FLATS	ITEM NO.	PRICE
1	11-1/2	2-3/16	HTDP100-11.5	133.46
1-1/4	11-1/2	3-1/8	HTDP116-11.5	179.02
1-1/2	11-1/2	3-1/8	HTDP132-11.5	260.50
2	11-1/2	3-3/4	HTDP200-11.5	693.52

CARBON STEEL
2 PIECE ADJUSTABLE DIES

TT-61

ICS WIS

GENERAL PURPOSE

CUT THREAD

Two Piece Adjustable Dies have a wide range of threading adjustments compared to a round adjustable die. Each half has two cutting edges and are easy to sharpen. They have chamfered threads on both sides. One side has 2 to 3 chamfered threads for regular work and the other side has 1-1/2 chamfered threads for threading close to shoulder. Ideal for threading or thread repair work.

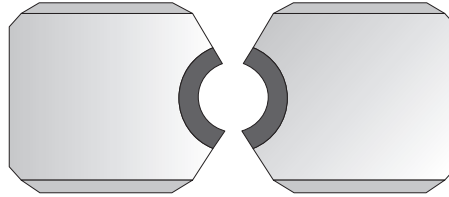

**RIGHT HAND
CUT**

SIZE	THREADS PER INCH	FOR USE WITH COLLET NO.	ITEM NO.
1/4	20	1 or 5	TPAD016-20
1/4	28	1 or 5	TPAD016-28
5/16	18	1 or 5	TPAD020-28
5/16	24	1 or 5	TPAD020-24
3/8	16	1 or 5	TPAD024-16
3/8	24	1 or 5	TPAD024-24
7/16	14	1 or 5	TPAD028-14
7/16	20	1 or 5	TPAD028-20
1/2	13	1 or 5	TPAD032-13
1/2	20	1 or 5	TPAD032-20
9/16	12	5	TPAD036-12
9/16	18	5	TPAD036-18
5/8	11	5 or 20	TPAD040-11
5/8	18	5 or 20	TPAD040-18
11/16	11	5 or 20	TPAD044-11
3/4	10	5 or 20	TPAD048-10
3/4	16	5 or 20	TPAD048-16
7/8	9	5, 20 or 25	TPAD056-09
7/8	14	5, 20 or 25	TPAD056-14
1	8	5, 20 or 25	TPAD100-08
1	12	5, 20 or 25	TPAD100-12
1	14	5, 20 or 25	TPAD100-14
1-1/8	14	20 or 25	TPAD108-14
1-1/4	14	20 or 25	TPAD116-14
1-3/8	14	25	TPAD124-14
1-1/2	14	25	TPAD132-14

Please specify collet no. when ordering.

HEXAGON AUTOMOTIVE RETHREADING DIES

ICS USA

GENERAL PURPOSE

CUT THREAD

Hexagon Automotive Rethreading Dies were designed to have a much smaller width across the flats than other hex dies to allow mechanics to repair damaged threads in tight spots. They are not designed for cutting new threads or to renew hardened threads. They are also known as "Tight Spot" Hex Repair Dies.

SMALL DIA.
ACROSS FLATS

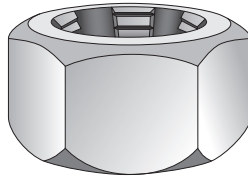

Fractional Right Hand Sizes (1/4" to 1-3/8")

DIA. ACROSS		ITEM		
SIZE	TPI	FLATS	NO.	PRICE
1/4	20	7/16	HARD016-20	1.88
1/4	28	7/16	HARD016-28	1.88
5/16	18	1/2	HARD020-18	2.02
5/16	24	1/2	HARD020-24	2.02
3/8	16	9/16	HARD024-16	2.10
3/8	24	9/16	HARD024-24	2.10
7/16	14	11/16	HARD028-14	2.20
7/16	20	11/16	HARD028-20	2.20
1/2	13	3/4	HARD032-13	2.52
1/2	20	3/4	HARD032-20	2.52
9/16	12	7/8	HARD036-12	3.28
9/16	18	7/8	HARD036-18	3.28
5/8	11	15/16	HARD040-11	3.44
5/8	18	15/16	HARD040-18	3.44

DIA. ACROSS		ITEM		
SIZE	TPI	FLATS	NO.	PRICE
11/16	11	1	HARD044-11	4.20
11/16	16	1	HARD044-16	4.20
3/4	10	1-1/16	HARD048-10	4.66
3/4	16	1-1/16	HARD048-16	4.66
7/8	9	1-1/4	HARD056-09	8.40
7/8	14	1-1/4	HARD056-14	8.40
1	8	1-1/2	HARD100-08	8.40
1	14	1-1/2	HARD100-14	8.40
1-1/8	7	1-5/8	HARD108-07	10.30
1-1/8	12	1-5/8	HARD108-12	10.30
1-1/4	7	1-3/4	HARD116-07	10.96
1-1/4	12	1-3/4	HARD116-12	10.96
1-3/8	12	2-1/16	HARD124-12	10.96

Fractional Left Hand Sizes (1/4" to 3/4")

DIA. ACROSS		ITEM		
SIZE	TPI	FLATS	NO.	PRICE
1/4	20	7/16	HARDL016-20	3.04
1/4	28	7/16	HARDL016-28	3.04
5/16	18	1/2	HARDL020-18	3.16
5/16	24	1/2	HARDL020-24	3.16
3/8	16	9/16	HARDL024-16	3.36
3/8	24	9/16	HARDL024-24	3.36
7/16	14	11/16	HARDL028-14	3.78
7/16	20	11/16	HARDL028-20	3.78

DIA. ACROSS		ITEM		
SIZE	TPI	FLATS	NO.	PRICE
1/2	13	3/4	HARDL032-13	4.20
1/2	20	3/4	HARDL032-20	4.20
9/16	12	7/8	HARDL036-12	4.62
9/16	18	7/8	HARDL036-18	4.62
5/8	11	15/16	HARDL040-11	5.26
5/8	18	15/16	HARDL040-18	5.26
3/4	10	1-1/16	HARDL048-10	8.20
3/4	16	1-1/16	HARDL048-16	10.92

Metric Right Hand Sizes (6.0mm to 24.0mm)

DIA. ACROSS		ITEM		
SIZE	PITCH	FLATS	NO.	PRICE
M6	1.00	M10	HARDM06.0X1.00	2.14
M6	1.25	M12	HARDM06.0X1.25	3.98
M7	1.00	M11	HARDM07.0X1.00	2.26
M8	1.00	M13	HARDM08.0X1.00	2.52
M8	1.25	M13	HARDM08.0X1.25	2.30
M8	1.50	M14	HARDM08.0X1.50	4.58
M10	1.00	M17	HARDM10.0X1.00	2.82
M10	1.25	M17	HARDM10.0X1.25	2.72
M10	1.50	M17	HARDM10.0X1.50	2.52
M11	1.50	M19	HARDM11.0X1.50	4.78
M12	1.25	M19	HARDM12.0X1.25	2.90
M12	1.50	M19	HARDM12.0X1.50	2.82
M12	1.75	M19	HARDM12.0X1.75	2.72

DIA. ACROSS		ITEM		
SIZE	PITCH	FLATS	NO.	PRICE
M14	1.25	M22	HARDM14.0X1.25	5.32
M14	1.50	M22	HARDM14.0X1.50	4.40
M14	2.00	M22	HARDM14.0X2.00	9.32
M16	1.50	M24	HARDM16.0X1.50	10.28
M16	2.00	M24	HARDM16.0X2.00	11.20
M18	1.50	M27	HARDM18.0X1.50	13.06
M18	2.50	M27	HARDM18.0X2.50	12.14
M20	1.25	M32	HARDM20.0X1.25	8.98
M20	1.50	M32	HARDM20.0X1.50	8.98
M22	1.00	M32	HARDM20.0X1.00	8.98
M22	1.50	M32	HARDM22.0X1.50	8.98
M24	1.50	M32	HARDM24.0X1.50	8.98
M24	2.00	M32	HARDM24.0X2.00	8.98

HIGH SPEED STEEL CONE DIES

ICS USA

SPECIAL PURPOSE

GROUND THREAD

Acorn Cone Dies are designed with a straight hook angle for production threading work on steel parts using screw machine or other threading equipment. They are designed to project from the die holder with a short die chamfer for close to the shoulder threading. They are also known as Spring Dies, Taper Nose Dies, Acorn Dies, and Cap Adjusting Dies.

(Advise if threading stainless or non-ferrous metals when ordering as they require a different hook angle.)

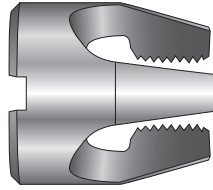

**RIGHT HAND
CUT**

SIZE	TPI	ITEM NO.
#1 BLANK (5/8" DIA.)		
#0	80	CD#1X#00-80
#1	64	CD#1X#01-64
#1	72	CD#1X#01-72
#2	56	CD#1X#02-56
#2	64	CD#1X#02-64
#3	48	CD#1X#03-48
#3	56	CD#1X#03-56
#4	40	CD#1X#04-40
#4	48	CD#1X#04-48
#5	40	CD#1X#05-40
#5	44	CD#1X#05-44
#6	32	CD#1X#06-32
#6	40	CD#1X#06-40
#8	32	CD#1X#08-32
#8	36	CD#1X#08-36
#10	24	CD#1X#10-24
#10	32	CD#1X#10-32
#12	24	CD#1X#12-24
#12	28	CD#1X#12-28
1/4	20	CD#1X016-20
1/4	28	CD#1X016-28

SIZE	TPI	ITEM NO.
#2 BLANK (7/8" DIA.)		
#6	32	CD#2X#06-32
#6	40	CD#2X#06-40
#8	32	CD#2X#08-32
#8	36	CD#2X#08-36
#10	24	CD#2X#10-24
#10	32	CD#2X#10-32
#12	24	CD#2X#12-24
#12	32	CD#2X#12-32
1/4	20	CD#2X016-20
1/4	28	CD#2X016-28
5/16	18	CD#2X020-18
5/16	24	CD#2X020-24
3/8	16	CD#2X024-16
3/8	24	CD#2X024-24
1/8	NPT	CDPT#2X008-27
1/8	NPS	CDPS#2X008-27

SIZE	TPI	ITEM NO.
#3 BLANK (1-1/4" DIA.)		
3/8	16	CD#3X024-16
3/8	24	CD#3X024-24
7/16	14	CD#3X028-14
7/16	20	CD#3X028-20
1/2	13	CD#3X032-13
1/2	20	CD#3X032-20
9/16	12	CD#3X036-12
9/16	18	CD#3X036-18
5/8	11	CD#3X040-11
5/8	18	CD#3X040-18
1/4	NPT	CDPT#3X016-18
3/8	NPT	CDPT#3X024-18
1/4	NPS	CDPS#3X016-18
3/8	NPS	CDPS#3X024-18

SIZE	TPI	ITEM NO.
#4 BLANK (1-3/4" DIA.)		
5/8	11	CD#4X040-11
5/8	18	CD#4X040-18
3/4	10	CD#4X048-10
3/4	16	CD#4X048-16
7/8	9	CD#4X056-09
7/8	14	CD#4X056-14
1	8	CD#4X100-08
1	12	CD#4X100-12
1	14	CD#4X100-14
1/2	NPT	CDPT#4X032-14
3/4	NPT	CDPT#4X048-14
1/2	NPS	CDPS#4X032-14
3/4	NPS	CDPS#4X048-14
#5 BLANK (2-5/32" DIA.)		
1-1/8	7	CD#5X108-07
1-1/8	12	CD#5X108-12
1-1/4	7	CD#5X116-07
1-1/4	12	CD#5X116-12
1-3/8	12	CD#5X124-12
1-1/2	12	CD#5X132-12

NOTE: We also have left hand and special thread sizes. Inquire for pricing.

[CALL FOR PRICE](#)

CONE DIE HOLDER

ICS USA

SPECIAL PURPOSE

PRECISION THREAD

Cone Die Holders are designed for use on automatic bar machines or any machine that can be set to reverse once the correct thread length has been cut. This holder is used for external threading with cone dies. Cone die holders are also known as Spring Die Holders, Acorn Die Holders, Taper Nose Die Holders and Cap Adjusting Die Holders.

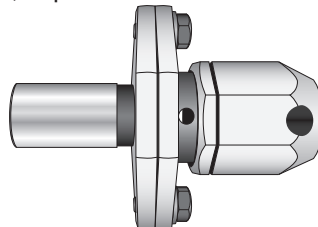

HOLDER SIZE	SHANK DIA.	HOLDS CONE DIE O.D.	CONE DIE CAPACITY	MAXIMUM LENGTH OF THREADS	ITEM NO.	PRICE
#1	5/8	5/8 (#1)	#0 - 1/4	1-1/2	CDH#1	-
#2	3/4	7/8 (#2)	#6 - 3/8	2-3/4	CDH#2X048	-
#2	1	7/8 (#2)	#6 - 3/8	3	CDH#2X100	CALL FOR PRICE
#3	3/4	1-1/4 (#3)	3/8 - 5/8	2-3/4	CDH#3X048	FOR PRICE
#3	1	1-1/4 (#3)	3/8 - 5/8	3-3/4	CDH#3X100	PRICE
#4	1	1-3/4 (#4)	5/8 - 1	2-1/2	CDH#4X100	-
#5	2	2-5/32 (#5)	1-1/8 - 1-1/2	3-3/4	CDH#5X200	-

ACME THREAD HEXAGON RETHREADING DIES

ICS USA

HEAVY DUTY

GROUND THREAD

Acme Thread Hexagon Rethreading Dies are of heavy duty construction for rethreading the broad, square threads on acme threaded rods and studs. They are used for general purpose acme threads with a class 2C thread fit. This is a looser fit than the class 2G precision acme thread.

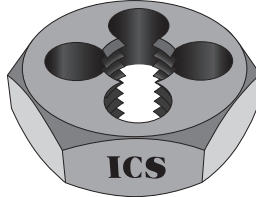

HEX NUT DIAMETER ACROSS FLATS

Right Hand Sizes 1/2" to 1-1/2"

SIZE	TPI	DIAMETER ACROSS FLATS	ITEM NO.
1/2	10	1-1/16	AHRD032-10
5/8	8	1-1/4	AHRD040-08
5/8	10	1-1/4	AHRD040-10
3/4	5	1-7/16	AHRD048-05
3/4	6	1-7/16	AHRD048-06
3/4	8	1-7/16	AHRD048-08
3/4	10	1-7/16	AHRD048-10
7/8	6	1-5/8	AHRD056-06

SIZE	TPI	DIAMETER ACROSS FLATS	ITEM NO.
1	4	1-13/16	AHRD100-04
1	5	1-13/16	AHRD100-05
1	10	1-13/16	AHRD100-10
1-1/8	5	2	AHRD108-05
1-1/4	4	2-3/16	AHRD116-04
1-1/4	5	2-3/16	AHRD116-05
1-1/2	4	2-9/16	AHRD132-04

Left Hand Sizes 1/2" to 1-1/2"

SIZE	TPI	DIAMETER ACROSS FLATS	ITEM NO.
1/2	10	1-1/16	AHRDL032-10
5/8	8	1-1/4	AHRDL040-08
5/8	10	1-1/4	AHRDL040-10
3/4	5	1-7/16	AHRDL048-05
3/4	6	1-7/16	AHRDL048-06
3/4	8	1-7/16	AHRDL048-08
3/4	10	1-7/16	AHRDL048-10
7/8	6	1-5/8	AHRDL056-06

SIZE	TPI	DIAMETER ACROSS FLATS	ITEM NO.
1	4	1-13/16	AHRDL100-04
1	5	1-13/16	AHRDL100-05
1	10	1-13/16	AHRDL100-10
1-1/8	5	2	AHRDL108-05
1-1/4	4	2-3/16	AHRDL116-04
1-1/4	5	2-3/16	AHRDL116-05
1-1/2	4	2-9/16	AHRDL132-04

NOTE: Acme Thread Hexagon Rethreading Dies are manufactured to order.

CALL FOR PRICE

CARBON STEEL
SOLID SQUARE BOLT DIES

TT-65

ICS WIS

GENERAL PURPOSE

CUT THREAD

Solid Square Bolt Dies are designed for rethreading damaged or jammed bolt threads and studs.

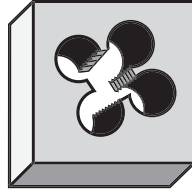

RIGHT HAND CUT

SIZE	TPI	SIZE OF SQUARE		ITEM NO.
		SQUARE	THICKNESS	
1/4	20	2-1/2	1/2	SSBD016-20X232
1/4	28	2-1/2	1/2	SSBD016-28X232
5/16	18	2-1/2	1/2	SSBD020-18X232
5/16	24	2-1/2	1/2	SSBD020-24X232
3/8	16	2-1/2	1/2	SSBD024-16X232
3/8	24	2-1/2	1/2	SSBD024-24X232
7/16	14	2-1/2	1/2	SSBD028-14X232
7/16	20	2-1/2	1/2	SSBD028-20X232
1/2	13	2-1/2	3/4	SSBD032-13X232
1/2	20	2-1/2	3/4	SSBD032-20X232
5/8	11	2-1/2	3/4	SSBD040-11X232
5/8	18	2-1/2	3/4	SSBD040-18X232
3/4	10	2-1/2	3/4	SSBD048-10X232
3/4	16	2-1/2	3/4	SSBD048-16X232
7/8	9	2-1/2	3/4	SSBD056-09X232
7/8	14	2-1/2	3/4	SSBD016-20X232

SIZE	TPI	SIZE OF SQUARE		ITEM NO.
		SQUARE	THICKNESS	
1	8	2-1/2	1	SSBD100-08X232
1	14	2-1/2	1	SSBD100-14X232
1-1/8	7	2-1/2	1	SSBD108-07X232
1-1/8	12	2-1/2	1	SSBD108-12X232
1-1/4	7	2-1/2	1	SSBD116-07X232
1-1/4	12	2-1/2	1	SSBD116-12X232
1-3/8	6	2-1/2	1	SSBD124-06X232
1-3/8	12	2-1/2	1	SSBD124-12X232
1-1/2	6	3	1	SSBD132-06X300
1-1/2	12	3	1	SSBD132-12X300
1-3/4	5	3	1-1/4	SSBD148-05X300
1-3/4	12	3	1-1/4	SSBD148-12X300
2	4-1/2	4	2	SSBD200-4.5X400
2	12	4	2	SSBD200-12X400

CARBON STEEL
SQUARE TAPER (NPT) PIPE DIES

ICS USA

SPECIAL PURPOSE

CUT THREAD

Solid Square Taper Pipe Dies are designed for rethreading damaged or jammed taper pipe threads and are used mainly by oil related industries, utilities, and general construction.

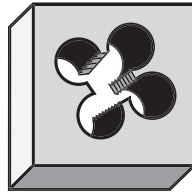

RIGHT HAND CUT

SIZE	THREADS PER INCH	SIZE OF SQUARE		ITEM NO.
		SQUARE	THICKNESS	
1/8	27	2	1/2	STPD008-27X200
1/4	18	2	1/2	STPD016-18X200
3/8	18	2	1/2	STPD024-18X200
1/2	14	2	1/2	STPD032-14X200
1/8	27	2-1/2	3/4	STPD008-27X232
1/4	18	2-1/2	3/4	STPD016-18X232
3/8	18	2-1/2	3/4	STPD024-18X232
1/2	14	2-1/2	3/4	STPD032-14X232
3/4	14	2-1/2	3/4	STPD048-14X232
3/4	14	3	3/4	STPD-048-14X300
1	11-1/2	3	3/4	STPD100-11.5X300
1-1/4	11-1/2	3	3/4	STPD116-11.5X300
1	11-1/2	4	1	STPD100-11.5X4
1-1/4	11-1/2	4	1	STPD116-11.5X4
1-1/2	11-1/2	4	1	STPD132-11.5X4
2	11-1/2	4	1	STPD200-11.5X4

CALL FOR PRICE

HEXAGON THREADING DIE SETS

WOODEN CASES

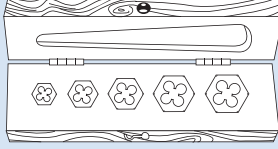
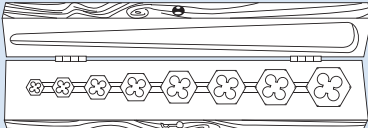
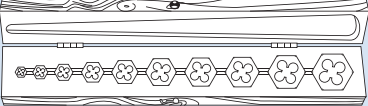
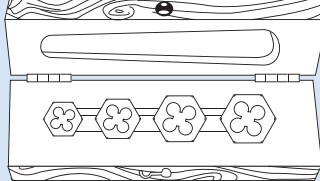
ILLUSTRATION	DESCRIPTION	CUT	THREAD TYPE	ITEM NO.	PRICE
5 PC HSS HEX DIE SET  SIZES: 1/4 to 1/2	5 PC Hex Die Set in a hinged wooden case. Contents of NC, NF, and Metric sets are listed below. (Specify style required.) Black & Gold finish.	Right Hand Right Hand	Coarse Fine	DS-HTD-5C DS-HTD-5F	131.28 131.28
NC (Coarse) 1/4-20, 5/16-18, 3/8-16, 7/16-14, 1/2-13 NF (Fine) 1/4-28, 5/16-24, 3/8-24, 7/16-20, 1/2-20					
8 PC HSS HEX DIE SET  SIZES: 1/4 to 3/4	8 PC Hex Die Set in a hinged wooden case. Contents of NC, NF, and Metric sets are listed below. (Specify style required.) Black & Gold finish.	Right Hand Right Hand	Coarse Fine	DS-HTD-8C DS-HTD-8F	223.54 223.54
NC (Coarse) 1/4-20, 5/16-18, 3/8-16, 7/16-14, 1/2-13, 9/16-12, 5/8-11, 3/4-10 NF (Fine) 1/4-28, 5/16-24, 3/8-24, 7/16-20, 1/2-20, 9/16-18, 5/8-18, 3/4-16					
10 PC HSS HEX DIE SET  SIZES: 1/4 to 1	10 PC Hex Die Set in a hinged wooden case. Contents of NC, NF, and Metric sets are listed below. (Specify style required.) Black & Gold finish.	Right Hand Right Hand	Coarse Fine	DS-HTD-10C DS-HTD-10F	328.24 328.24
NC (Coarse) 1/4-20, 5/16-18, 3/8-16, 7/16-14, 1/2-13, 9/16-12, 5/8-11, 3/4-10, 7/8-9, 1-8 NF (Fine) 1/4-28, 5/16-24, 3/8-24, 7/16-20, 1/2-20, 9/16-18, 5/8-18, 3/4-16, 7/8-14, 1-14					
4 PC HSS HEX DIE SET  SIZES: 1-1/8 to 1-1/2	4 PC Hex Die Set in a hinged wooden case. Contents of NC, NF, and Metric sets are listed below. (Specify style required.) Black & Gold finish.	Right Hand Right Hand	Coarse Fine	DS-HTD-4C DS-HTD-4F	465.26 465.26
NC (Coarse) 1-1/8-7, 1-1/4-7, 1-3/8-6, 1-1/2-6 NF (Fine) 1-1/8-12, 1-1/4-12, 1-3/8-12, 1-1/2-12					

NOTE: Special boxed sets can be made to your requirements.

40 PC TAP AND HEX DIE SETS

TT-67

PLASTIC CASES

ILLUSTRATION	DESCRIPTION	STEEL SPEC	CUT	THREAD TYPE	ITEM NO.	PRICE
	40 PC Tap and Hex Die Set in plastic case. Each set contains one each NC and NF Plug Tap and Hexagon Die. Sizes are listed below. Set also includes 1/8-27 NPT Pipe Tap and 6 threading tools.	CS	Right Hand	NC, NF NPT	THDS-CS-40	181.60
		HSS	Right Hand	NC, NF NPT	THDS-HS-40	233.98
SIZES OF TAPS AND HEX DIES IN SET						
NC (Coarse) #4-40, #6-32, #8-32, #10-24, #12-24, 1/4-20, 5/16-18, 3/8-16, 7/16-14, 1/2-13 NF (Fine) #10-32, 1/4-28, 5/16-24, 3/8-24, 7/16-20, 1/2-20 NPT (Regular Taper) 1/8-27						
THREADING TOOLS IN SET						
Adjustable Die Stock - 1" round or hex T-Handle Tap Wrench - #0 to 1/4" Adjustable Tap Wrench - #4 to 1/2" T-Handle Tap Wrench - 1/4" to 1/2" Screw Pitch Gauge - Fractional #5 Screwdriver						

40 PC METRIC TAP AND HEX DIE SET

PLASTIC CASES

ILLUSTRATION	DESCRIPTION	STEEL SPEC	CUT	THREAD TYPE	ITEM NO.	PRICE
	40 PC Tap and Hex Die Set in plastic case. Each set contains one each NC and NF Plug Tap and Hexagon Die. Sizes are listed below. Set also includes 1/8-28 BSPT Pipe Tap and 6 threading tools.	CS	Right Hand	NC, NF BSPT	THDS-CS-40M	189.24
SIZES OF TAPS AND HEX DIES IN SET						
NC (Coarse) M3.0 x .50, M4.0 x .70, M5.0 x .80, M6.0 x 1.0, M7.0 x 1.0, M8.0 x 1.25 M9.0 x 1.25, M10.0 x 1.50, M11.0 x 1.50, M12.0 x 1.75 NF (Fine) M3.0 x .60, M4.0 x .75, M5.0 x .90, M9.0 x 1.00, M10.0 x 1.25, M12.0 x 1.50 BSPT (British Standard) 1/8-28						
THREADING TOOLS IN SET						
Adjustable Die Stock - 1" round or hex T-Handle Tap Wrench - M3 to M6 Adjustable Tap Wrench - M3 to M12 T-Handle Tap Wrench - M6 to M12 Screw Pitch Gauge - Metric #5 Screwdriver						

58 PC TAP AND HEX DIE SETS

PLASTIC CASES

58 Piece Tap and Die Sets were originally designed to be a more advanced general purpose tap and die set for mechanics and DIY'ers for maintenance on domestic cars, motorcycles, and machinery that were manufactured using the unified inch thread standard. Each set contains the most popular sizes (#6-32 to 3/4-16) sizes that mechanics commonly use. Plastic case has individual compartments for tap and die storage and easy access.

ILLUSTRATION	DESCRIPTION	STEEL	THREAD	ITEM	PRICE	
		SPEC	CUT	NO.		
 <p>SIZES #6 TO 3/4"</p>	Each set contains one each NC and NF Plug Tap and Hexagon Die in your choice of either Carbon Steel, High Speed Steel, or a combination (High Speed Steel Taps and Carbon Steel Hexagon Dies).	CS	Right Hand	NC, NF NPT	THDS-CS-58	381.02
		HSS	Right Hand	NC, NF NPT	THDS-HS-58	778.52
		HSS & CS	Right Hand	NC, NF NPT	THDS-HS/C-58	558.60
SIZES OF TAPS AND HEX DIES IN SET						
NC (Coarse) #6-32, #8-32, #10-24, #12-24, 1/4-20, 5/16-18, 3/8-16, 7/16-14, 1/2-13, 9/16-12, 5/8-11, 3/4-10 NF (Fine) #10-32, 1/4-28, 5/16-24, 3/8-24, 7/16-20, 1/2-20, 9/16-18, 5/8-18, 3/4-16 NPT (Regular Taper) 1/8-27, 1/4-18						
THREADING TOOLS IN SET						
Adjustable Tap Wrench - #4 to 1/2" T-Handle Tap Wrench - #0 - 1/4" Adjustable Tap Wrench - 1/4 to 3/4" Screw Pitch Gauge - Fractional Die Stock - 1" Round or Hex Screwdriver - 1/8" x 2-1/4" Pocket Clip Die Stock - 1-1/2" Round or 1-7/16" Hex Screw Extractors - Spiral Flute -#1 to 5						

Standard Packaging - 1 Ea. Box (Wt. 15.0 lbs.)

65 PC TAP AND HEX DIE SETS

PLASTIC CASES

65 Piece Tap and Die Sets were originally designed to be a professional general purpose tap and die set for mechanics and DIY'ers for maintenance on domestic cars, motorcycles, and machinery that were manufactured using the unified inch thread standard. Each set contains the most popular sizes (#4-40 to 1-14) sizes that mechanics commonly use. Plastic case has individual compartments for tap and die storage and easy access.

ILLUSTRATION	DESCRIPTION	STEEL	THREAD	ITEM	PRICE	
		SPEC	CUT	NO.		
 <p>SIZES #4 TO 1"</p>	Each set contains one each NC and NF Plug Tap and Hexagon Die in your choice of either Carbon Steel, High Speed Steel, or a combination (High Speed Steel Taps and Carbon Steel Hexagon Dies).	CS	Right Hand	NC, NF NPT	THDS-CS-65	651.50
		HSS	Right Hand	NC, NF NPT	THDS-HS-65	1131.32
		HSS & CS	Right Hand	NC, NF NPT	THDS-HS/C-65	970.20
SIZES OF TAPS AND HEX DIES IN SET						
NC (Coarse) #4-40, #6-32, #8-32, #10-24, #12-24, 1/4-20, 5/16-18, 3/8-16, 7/16-14, 1/2-13, 9/16-12, 5/8-11, 3/4-10, *7/8-9, *1-8 NF (Fine) #10-32, 1/4-28, 5/16-24, 3/8-24, 7/16-20, 1/2-20, 9/16-18, 5/8-18, 3/4-16, *7/8-14, *1-14 NPT (Regular Taper) 1/8-27, 1/4-18						
THREADING TOOLS IN SET						
Adjustable Tap Wrench - #4 to 1/2" Die Stock - 1-7/8" Hex Adjustable Tap Wrench - 1/4 to 3/4" T-Handle Tap Wrench - #0 - 1/4" Adjustable Tap Wrench - 1/2 to 1-1/8" Screw Pitch Gauge - Fractional Die Stock - 1" Round or Hex Screwdriver - 1/8" x 2-1/4" Pocket Clip Die Stock - 1-1/2" Round or 1-7/16" Hex						

Standard Packaging - 1 Ea. Box (Wt. 23.0 lbs.) • *7/8 & 1" NC & NF Hex Dies only available in High Carbon Steel.

117 PC TAP AND HEX DIE SET

TT-69

PLASTIC CASES

117 Piece Titanium Nitride Coated Tap and Hexagon Die Sets are designed to be a professional tap and die set for mechanics and DIY'ers for maintenance on domestic cars, motorcycles, and machinery that were manufactured using the unified inch thread standard. Each set contains the most popular fractional size (1/4 to 1/2 NF/NC) and metric size (3mm to 12mm) taps and dies as well as five spiral screw extractors with corresponding tap drill sizes. The plastic case has individual compartments for all taps, dies, screw extractors and drills for easy access.

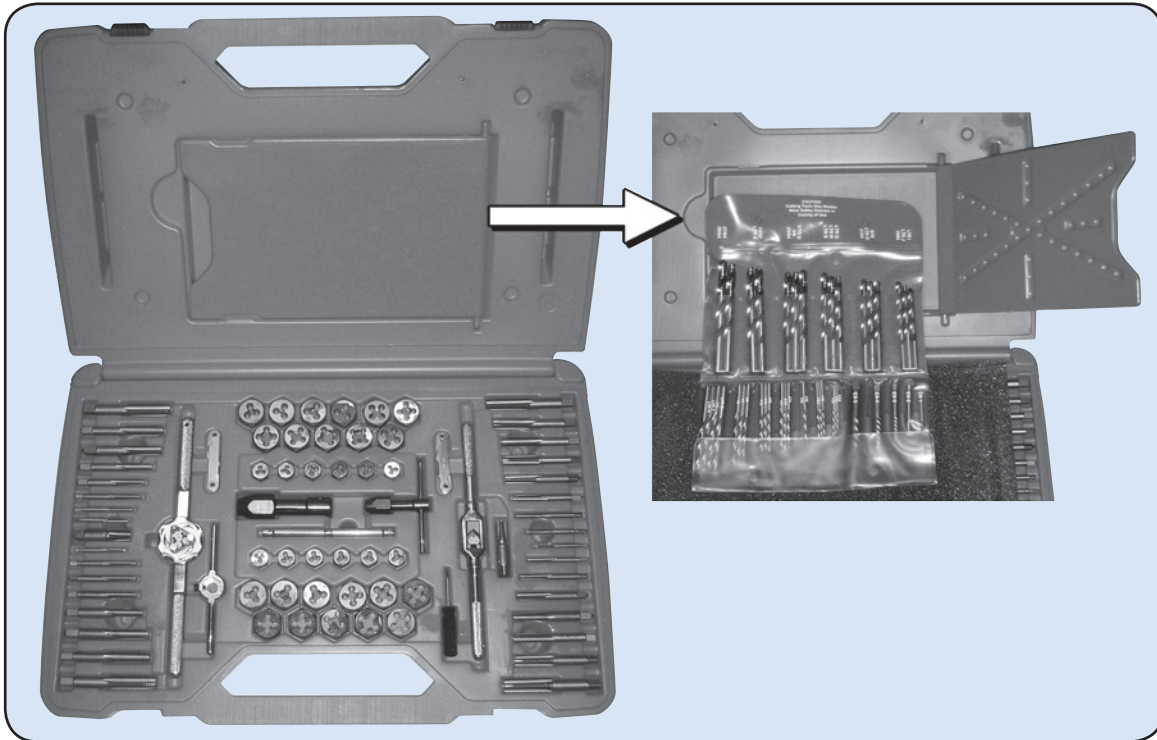

DESCRIPTION	CUT	THREAD TYPE	ITEM NO.	PRICE
Each set contains one each NC and NF fractional and metric plug taps and dies sizes. Sizes listed below. Set also includes 5 screw extractors and tap drills. All tools are titanium nitride coated.	Right Hand	NC, NF, NPT	THDS-CS-117	378.58
SIZES OF TAPS AND HEX DIES IN SET				
NC (Coarse)	1/4-20, 5/16-18, 3/8-16, 7/16-14, 1/2-13, M3.0x0.50, M4.0x0.75, M5.0x0.90, M7.0x1.0, M8.0x1.25, M9.0x1.25, M10.0x1.50, M12.0x1.75			
NF (Fine)	1/4-28, 5/16-24, 3/8-24, 7/16-20, 1/2-20, M4.0x0.70, M5.0x0.80, M6.0x1.00, M8.0x1.00, M9.0x1.00, M10.0x1.25, M11x1.50, M12.0x1.50			
NPT (Regular Taper)	1/8-27			
BSPT (British Standard)	1/8-28			
SIZES OF DRILLS IN SET				
Fractional Sizes	5/64, 7/64, 5/32, 1/4, 19/64, 5/16, 21/64, 3/8, 25/64, 13/32, 27/64, 29/64			
Wire Gauge Sizes	#3, #7, #9, #16, #19, #20, #21, #25, #29, #30, #36, #39, #43			
Letter Drill Sizes	B, F, H, I, J, O, Q, R, S, U, Z			
SIZES OF SCREW EXTRACTORS				
Screw Extractor Sizes	#1, #2, #3, #4, #5			
THREADING TOOLS IN SET				
Adjustable Tap Wrench - #4 to 1/2"	T-Handle Tap Wrench - #0 - 1/4"			
Die Stock - 5/8" Hex	T-Handle Tap Wrench - 1/4" - 1/2"			
Die Stock - 1" Hex	Screw Pitch Gauge - Fractional			
Screwdriver - 1/8"	Screw Pitch Gauge - Metric			

45 PC CARBON TAP AND ROUND ADJUSTABLE DIE SET

PLASTIC CASES

45 Piece Carbon Steel Fractional Tap and Die Sets were originally designed to be a basic general purpose tap and die set for mechanics and DIY'ers for maintenance on domestic cars, motorcycles, and machines that were manufactured using the unified inch thread standard. Each set contains the most popular sizes (1/4-20 to 1-14) that mechanics commonly use. Plastic case has individual compartments for tap and die storage and easy access.

ILLUSTRATION	DESCRIPTION	THREAD		ITEM NO.	PRICE	
		CUT	TYPE			
 <p>45 PC TAP AND ROUND ADJUSTABLE DIE SET</p>	Each set contains one each NC and NF Plug Tap and Round Adjustable Die. SIZES: 1/4" to 1"	Right Hand	NC, NF	TRDS-CS-45	581.70	
	SIZES OF TAPS AND ROUND ADJUSTABLE DIES IN SET					
	NC (Coarse)	#6-32, #8-32, #10-24, #12-24, 1/4-20, 5/16-18, 3/8-16, 7/16-14, 1/2-13, 9/16-12, 5/8-11, 3/4-10, 1-8				
	NF (Fine)	#10-32, 1/4-28, 5/16-24, 3/8-24, 7/16-20, 1/2-20, 9/16-18, 5/8-18, 3/4-16, 1-14				
	DIE DIMENSIONS AND DIE SIZES					
	1-1/2" Round Adjustable Dies	1/4" to 5/8"				
	2" Round Adjustable Dies	3/4" to 1"				
THREADING TOOLS IN SET						
Adjustable Tap Wrench - #4 to 1/2"		T-Handle Tap Wrench - #0 - 1/4"				
Adjustable Tap Wrench - 1/4 to 3/4"		Screw Pitch Gauge - Fractional				
Die Stock - 1" Round or Hex		Screwdriver - 1/8" x 2-1/4" Pocket Clip				

Standard Packaging - 1 Ea. Box (Wt. 23.0 lbs.)

45 PC METRIC CARBON TAP AND ROUND ADJUSTABLE DIE SET

PLASTIC CASES

45 Piece Carbon Steel Metric Tap and Die Sets were originally designed to be a basic general purpose tap and die set for mechanics and DIY'ers for maintenance on foreign cars, motorcycles, and machines that were manufactured using the unified inch thread standard. Each set contains the most popular metric sizes (M6 to M24) that mechanics commonly use. Plastic case has individual compartments for tap and die storage and easy access. With the advent of world trade, this set is now a staple in every tool box and workshop.

ILLUSTRATION	DESCRIPTION	THREAD		ITEM NO.	PRICE	
		CUT	TYPE			
 <p>45 PC METRIC TAP AND ROUND ADJUSTABLE DIE SET</p>	Each set contains one each NC and NF Plug Tap and Round Adjustable Die. SIZES: M6 to M24	Right Hand	NC, NF	TRDS-CS-45M	581.70	
	SIZES OF TAPS AND ROUND ADJUSTABLE DIES IN SET					
	NC (Coarse)	M6x1.00, M8x1.25, M10x1.50, M12x1.75, M14x2.00, M16x2.00, M18x2.50, M20x2.50, M22x2.50, 24x3.00				
	NF (Fine)	M6x0.75, M8x1.00, M10x1.25, M12x1.50, M14x1.50, M16x1.50, M18x1.50, M20x1.50, M22.0x1.50, M24x1.50				
	DIE DIMENSIONS AND DIE SIZES					
	1-1/2" Round Adjustable Dies	M6 to M18				
	2" Round Adjustable Dies	M20 to M24				
THREADING TOOLS IN SET						
Adjustable Tap Wrench - M6 to M18		T-Handle Tap Wrench - M6 to M12				
Die Stock Adapter - 1-1/2"		Screwdriver				
Die Stock - 2" Round						

Standard Packaging - 1 Ea. Box (Wt. 23.0 lbs.)

18 PC TAP AND DRILL SETS

TT-71

METAL INDEXES

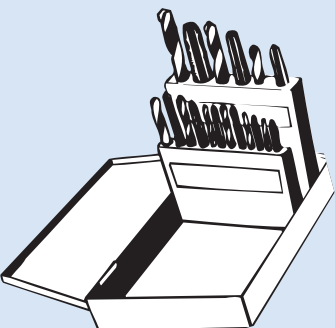
ILLUSTRATION	THREAD FORM	STYLE OF TAPS	CHAMFER	ITEM NO.	PRICE EACH	
	Coarse	HSS Spiral Point Tap	Plug	TDS-SPT-18C	100.72	
	Fine	HSS Spiral Point Tap	Plug	TDS-SPT-18F	102.62	
	Metric	HSS Spiral Point Tap	Plug	TDS-SPTM-18M	134.24	
	Coarse	TiN Coated Spiral Point Tap	Plug	TDS-SPTT-18C	202.36	
	Coarse	HSS Standard Hand Tap	Plug	TDS-SHT-18C	95.56	
	Fine	HSS Standard Hand Tap	Plug	TDS-SHT-18F	95.56	
	Metric	HSS Standard Hand Tap	Plug	TDS-SHTM-18M	110.90	
	Coarse	TiN Coated Std. Hand Tap	Plug	TDS-SHTT-18C	189.10	
	SIZES OF COARSE TAPS AND DRILLS IN 18 PC SETS					
	TAPS - #6-32, #8-32, #10-24, #10-32, 1/4-20, 5/16-18, 3/8-16, 7/16-14, 1/2-13 (COARSE) DRILLS - #36, #29, #25, #21, #7, "F", 5/16, "U", 27/64					
SIZES OF FINE TAPS AND DRILLS IN 18 PC SETS						
TAPS - #6-40, #8-36, #10-24, #10-32, 1/4-28, 5/16-24, 3/8-24, 7/16-20, 1/2-20 (FINE) DRILLS - #33, #29, #25, #21, #3, "I", "Q", 25/64, 29/64						
SIZES OF METRIC TAPS AND DRILLS IN 18 PC SETS						
TAPS - M2.5x.45, M3.0x.50, M3.5x.60, M4.0x.70, M5.0x.80, M6.0x1.00, M8.0x1.25, M10.0x1.50, M12.0x1.75 DRILLS - M2.05, M2.50, M2.90, M3.30, M4.20, M5.00, M6.70, M8.50, M10.20 (METRIC)						

TAP AND DRILL DISPENSER

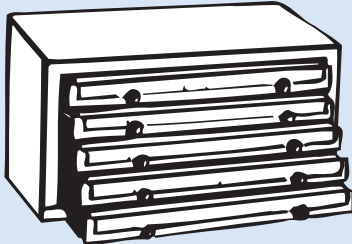
ILLUSTRATION	ITEM TYPE	ITEM NO.	EACH
 <p>Size: 7-3/8 x 7-3/4 x 14-5/8</p>	Dispenser Only (Wt. 10-1/2 lbs.)	D-TD-336	102.90
	DISPENSER WILL HOLD 12 EACH OF FOLLOWING		
	TAPS - #6-32, #8-32, #10-24, #10-32, 1/4-20, 1/4-28, 5/16-18, 5/16-24, 3/8-16, 3/8-24, 7/16-14, 7/16-20, 1/2-13, 1/2-20 DRILLS - #36, #29, #25, #21, #7, #3, "F", "I", 5/16, "Q", "U", 25/64, 27/64, 29/64		

TAP DISPENSERS

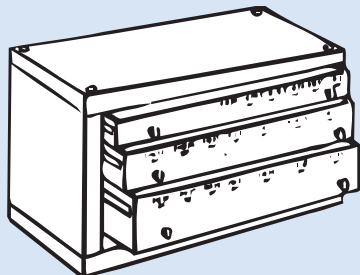
ILLUSTRATION	CAPACITY	ITEM NO.	EACH
 <p>Size: 7-3/8 x 7-3/4 x 14-5/8</p>	Holds fractional sizes 1/4-20 to 1-14 (Wt. 10-1/2 lbs.)	TD-FRACT	106.42
	Holds machine screw sizes 2-56 to 12-28 (Wt. 13 lbs.)	TD-MACH	131.62
	Holds metric sizes M3 to M24 (Wt. 10-1/2 lbs.)	TD-MM	106.42
Note: Dispenser will hold up to 12 each of every size.			

21 PC TAP AND ROUND ADJUSTABLE DIE SETS

WOODEN CASES

ILLUSTRATION	DESCRIPTION	STEEL SPEC	CUT	THREAD TYPE	ITEM NO.	PRICE
 <p>Sizes 1/4 to 3/4</p>	21 PC Tap and 1-1/2" Round Adjustable Die Set. Each set contains one Plug Tap and Round Adjustable Die in NC or NF Thread Form. Sizes are listed below. Set also includes 5 threading tools.	HSS	Right Hand	Coarse	TRDS-SHT-21C	530.32
		HSS	Right Hand	Fine	TRDS-SHT-21F	530.32
		HSS	Left Hand	Coarse	TRDS-SHTL-21C	558.14
		HSS	Left Hand	Fine	TRDS-SHTL-21F	558.14
		TiN *	Right Hand	Coarse	TRDS-SHTT-21C	606.32
		TiN *	Right Hand	Fine	TRDS-SHTT-21F	606.32
SIZES OF TAPS AND ROUND DIES IN SET						
NC (Coarse) - 1/4-20, 5/16-18, 3/8-16, 7/16-14, 1/2-13, 9/16-12, 5/8-11, 3/4-10 NF (Fine) - 1/4-28, 5/16-24, 3/8-24, 7/16-20, 1/2-20, 9/16-18, 5/8-18, 3/4-16 * Only taps are TiN Coated in set.						
THREADING TOOLS IN SET						
Adjustable Die Stock - 1-1/2" round T-Handle Tap Wrench - 1/4 to 1/2 Adjustable Tap Wrench - 1/4 to 1 #5 Screwdriver Screw Pitch Gauge - Fractional						

21 PC METRIC TAP AND ROUND ADJUSTABLE DIE SET

WOODEN CASES

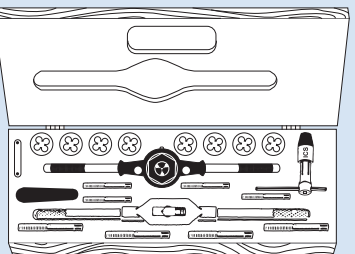
ILLUSTRATION	DESCRIPTION	STEEL SPEC	CUT	THREAD TYPE	ITEM NO.	PRICE	
 <p>Sizes M6 to M20</p>	21 PC Tap and 1-1/2" Metric Round Adjustable Die Set. Each set contains one Plug Tap and Round Adjustable Die. Sizes are listed below. Set also includes 5 threading tools.	HSS	Right Hand	Metric Coarse	TRDS-SHTM-21C	582.10	
		SIZES OF TAPS AND ROUND DIES IN SET					
		NC (Coarse) - M6.0 x 1.0, M8.0 x 1.25, M10.0 x 1.5, M12.0 x 1.75, M14.0 x 2.0, M16.0 x 2.0, M18.0 x 2.5, M20.0 x 2.50					
THREADING TOOLS IN SET							
Adjustable Die Stock - 1-1/2" round T-Handle Tap Wrench - M6 to M12 Adjustable Tap Wrench - M6 to M24 #5 Screwdriver Screw Pitch Gauge - Metric							

NOTE: Special boxed sets can be made to your requirements.

THREAD RESTORING FILES

ICS USA

SPECIAL PURPOSE

PRECISION CUT



Thread Restoring Files are designed to restore damaged external and internal threads of any diameter with one tool. They can be used on right or left hand threads or even be used as a thread gauge.

THREAD TYPE	LENGTH x SIZE	THREADS	ITEM NO.	PRICE
Regular	9-1/4 x 3/8	11, 12, 13, 14, 16, 18, 20, 24	TRF-R	50.86
Extra Fine/Coarse	9-1/4 x 3/8	9, 10, 12, 16, 20, 27, 28, 32	TRF-X	50.86
Metric	9-1/4 x 3/8	.75, 1.00, 1.25, 1.50, 1.75, 2.00, 2.50, 3.00	TRF-M	50.86
Pipe	9-1/4 x 3/8	8, 10, 11-1/2, 14, 16, 18, 24, 27	TRF-P	50.86

54 PC AUTOMOTIVE RETHREADING TAP & DIE SET

TT-73

PLASTIC CASES

ILLUSTRATION	DESCRIPTION	CUT	THREAD TYPE	ITEM NO.	PRICE
 <p>54 PC AUTOMOTIVE RETHREADING TAP & DIE SET</p> <p>1/4 to 5/8 M6 to M14</p>	Each set contains one each NC & NF fractional & metric automotive rethreading taps and hex dies. Set also includes 3 thread restoring files.	Right Hand	NC & NF	ARTDS-54	123.90
	SIZES OF AUTOMOTIVE RETHREADING TAPS IN SET				
	NC-USS (Coarse) - 1/4-20, 5/16-18, 3/8-16, 7/16-14, 1/2-13, 9/16-12				
	NF-SAE (Fine) - 1/4-28, 5/16-24, 3/8-24, 7/16-20, 1/2-20, 9/16-18				
	METRIC - 6x1.0, 8x1.25, 8x1.50, 10x1.00, 10x1.25, 10x1.50, 11x1.50, 12x1.25, 12x1.50, 12x1.75, 14x1.50				
	SIZES OF AUTOMOTIVE RETHREADING DIES IN SET				
	NC-USS (Coarse) - 1/4-20, 5/16-18, 3/8-16, 7/16-14, 1/2-13, 9/16-12, 5/8-11				
NF-SAE (Fine) - 1/4-28, 5/16-24, 3/8-24, 7/16-20, 1/3-20, 9/16-18, 5/8-18					
METRIC - 6x1.00, 6x1.25, 7x1.00, 8x1.00, 8x1.25, 8x1.50, 10x1.00, 10x1.25, 10x1.50, 11x1.50, 12x1.25, 12x1.50, 12x1.75, 14x1.50					
THREAD RESTORING FILES IN SET					
Regular File for - 11, 12, 13, 14, 16, 18, 20, 24 threads per inch					
Metric File for - .80, 1.00, 1.25, 1.50, 1.75, 2.00, 2.50, 3.00 threads per inch					
Fine/Pipe File for - 8, 9, 10, 11-1/2, 20, 27, 28, 32 threads per inch					

18 PC THREAD RESTORING FILE & AUTOMOTIVE DIE SETS

PLASTIC CASES

ILLUSTRATION	DESCRIPTION	CUT	THREAD TYPE	ITEM NO.	PRICE
 <p>18 PC AUTOMOTIVE FILE & AUTOMOTIVE DIE SET</p>	Each set contains one each NC & NF fractional automotive hexagon rethreading dies. Set also includes 2 thread restoring files.	Right Hand Left Hand	NC & NF NC & NF	TRFADS-18 TRFADS-18L	50.40 80.14
	SIZES OF AUTOMOTIVE RETHREADING DIES IN SET				
	NC-USS (Coarse) - 1/4-20, 5/16-18, 3/8-16, 7/16-14, 1/2-13, 9/16-12, 5/8-11, 3/4-10				
	NF-SAE (Fine) - 1/4-28, 5/16-24, 3/8-24, 7/16-20, 1/3-20, 9/16-18, 5/8-18, 3/4-16				
	THREAD RESTORING FILES IN SET				
	Regular File for - 11, 12, 13, 14, 16, 18, 20, 24 threads per inch				
	Extra Fine/Coarse File for - 9, 10, 12, 16, 20, 27, 28, 32 threads per inch				
AVAILABLE IN RIGHT OR LEFT HAND THREAD					

13 PC METRIC THREAD RESTORING FILE & AUTOMOTIVE DIE SET

PLASTIC CASES

ILLUSTRATION	DESCRIPTION	CUT	THREAD TYPE	ITEM NO.	PRICE
 <p>13 PC AUTOMOTIVE FILE & AUTOMOTIVE DIE SET</p>	Each set contains one each metric automotive hexagon rethreading dies and one each thread restoring file.	Right Hand	Metric	TRFADS-13M	37.28
	SIZES OF AUTOMOTIVE RETHREADING DIES IN SET				
	METRIC - 6x1.0, 6x1.25, 8x1.00, 8x1.25, 8x1.50, 10x1.00, 10x1.25, 10x1.50, 12x1.25, 12x1.50, 14x1.25, 14x1.50				
	THREAD RESTORING FILES IN SET				
Metric File for - .80, 1.00, 1.25, 1.50, 1.75, 2.00, 2.50, 3.00 threads per inch					

HIGH SPEED STEEL 30 PC MINIATURE TAP AND ROUND DIE SET

PLASTIC CASE

30 piece High Speed Steel Machine Screw Size Miniature Tap and Die Sets are designed to be a professional general purpose tap and die set with all the most popular tap and die machine screw sizes (#0 to #4-40) for use by camera repair shops, clock repair shops, model builders, jewelry manufacturers, business machine repair, electronic equipment, mold and die makers, medical equipment repair, fishing lure manufacturers, and tongue and body piercing. Plastic case has individual compartments for tap and die storage and easy access.

ILLUSTRATION	DESCRIPTION	STEEL SPEC	THREAD CUT	THREAD TYPE	ITEM NO.	PRICE	
	Each set contains 2 plug taps and 1 round die for every size. Set also includes multi-size tap and die holder.	HSS	Right Hand	NC, NF UM	MTRDS-30	40.96	
	SIZES OF TAPS AND ROUND DIES IN SET						
	NC (Coarse)	#0-80, #1-64, #2-56, #3-48, #4-40					
	NF (Fine)	#0-90, #1-72, #2-64, #3-56					
	TAP AND ROUND DIE HOLDER IN SET						
Multi-Size Tap and Die Holder holds 5/8 or 7/16 round dies and has two collet guides for holding taps. Both taps and dies lock into position with one screw.							

HIGH SPEED STEEL 30 PC METRIC MINIATURE TAP AND ROUND DIE SET

PLASTIC CASE

30 piece High Speed Steel Metric Size Miniature Tap and Die Sets are designed to be a professional general purpose tap and die set with all the most popular tap and die metric sizes (M1.00 to M2.50) for use by camera repair shops, clock repair shops, model builders, jewelry manufacturers, business machine repair, electronic equipment, mold and die makers, medical equipment repair, fishing lure manufacturers, and tongue and body piercing. Plastic case has individual compartments for tap and die storage and easy access.

ILLUSTRATION	DESCRIPTION	STEEL SPEC	THREAD CUT	THREAD TYPE	ITEM NO.	PRICE	
	Each set contains 2 plug taps and 1 round die for every size. Set also includes multi-size tap and die holder.	HSS	Right Hand	NC, NF UM	MTRDS-30M	40.96	
	SIZES OF TAPS AND ROUND DIES IN SET						
	METRIC SIZES	M1.0x0.25, M1.1x0.25, M1.2x0.25, M1.4x0.30, M1.6x0.35 M1.8x0.35, M2.0x0.40, M2.2x0.45, M2.5x0.45					
	TAP AND ROUND DIE HOLDER IN SET						
	Multi-Size Tap and Die Holder holds 5/8 or 7/16 round dies and has two collet guides for holding taps. Both taps and dies lock into position with one screw.						

5 PC MODEL AIRPLANE TAP SETS

PLASTIC CASE

Model Airplane Tap Sets were designed for the model airplane enthusiast. Available in High Speed Steel or Carbon Steel, each set contains the most popular tap sizes (#2-56 to #8-32) that model airplane builders use. Plastic case has individual compartments for tap storage and easy access.

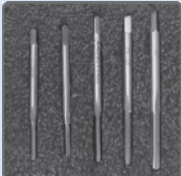
ILLUSTRATION	DESCRIPTION	STEEL SPEC	THREAD TYPE	ITEM NO.	PRICE	
	Each set contains one each of listed NC (Coarse) tap sizes.	Carbon Steel High Speed Steel	NC NC	MATS-CS-5 MATS-HS-5	22.06 30.46	
	SIZES OF TAPS IN SET					
	NC (Coarse)	#2-56, #3-48, #4-40, #6-32, #8-32				

8 PC RATCHETING PIPE THREADER SET

PLASTIC CASE

The 8 Piece Ratcheting Pipe Threader Set was designed to cut precision NPT pipe threads measuring 3/8", 1/2", 3/4", 1", or 1-1/4". It is a compact and sturdy set complete with unscrewable ratchet handle and extension. Die heads snap in and can be removed by pulling the ratchet knob out to position. Ratchet knob can be set for forward or reverse direction. Tools in set are made of alloy steel and malleable iron to withstand severe usage. Set comes complete with heavy duty plastic case with carrying handle for easy transportation and storage.

ILLUSTRATION	THREADING TOOLS IN SET	THREAD FORM	ITEM NO.	PRICE
<p data-bbox="180 436 444 491">8 PC RATCHETING PIPE THREADER SET</p> 	<p data-bbox="578 436 987 569">Die Heads 3/8, 1/2, 3/4, 1, & 1-1/4 Ratchet Head (Exposed Style) Ratchet Handle Ratchet Handle Extension</p>	<p data-bbox="1130 436 1187 464">NPT</p>	<p data-bbox="1304 436 1409 464">RPTS-8</p>	<p data-bbox="1458 436 1528 464">96.92</p>

7 PC RATCHETING PIPE THREADER SET

PLASTIC CASE

The 7 Piece Ratcheting Pipe Threader Set was designed to cut large precision NPT pipe threads measuring 1-1/4", 1-1/2" and 2". It is a compact and sturdy set complete with unscrewable ratchet handle and extension. Die heads snap in and can be removed by pulling the ratchet knob out to position. Ratchet knob can be set for forward or reverse direction. Tools in set are made of alloy steel and malleable iron to withstand severe usage. Set comes complete with heavy duty plastic case with carrying handle for easy transportation and storage.

ILLUSTRATION	THREADING TOOLS IN SET	THREAD FORM	ITEM NO.	PRICE
<p data-bbox="180 1388 444 1442">7 PC RATCHETING PIPE THREADER SET</p> 	<p data-bbox="578 1388 938 1520">Die Heads 1-1/4, 1-1/2, & 2 Ratchet Head (Exposed Style) Ratchet Handle Ratchet Handle Extensions (2)</p>	<p data-bbox="1130 1388 1187 1415">NPT</p>	<p data-bbox="1304 1388 1409 1415">RPTS-7</p>	<p data-bbox="1458 1388 1528 1415">101.80</p>

5 PC RATCHETING TAP AND DIE TOOL SET

STEEL CASE

The 5 Piece Ratcheting Tap and Die Tool Sets are designed to be a professional general purpose tap and die tool set for mechanics and DIYers for maintenance on domestic cars and motorcycles. Each set contains the most popular tap sockets (#6 to 1/2") and 1" hex die adapter with ratcheting handle. Steel case has individual compartments for ratcheting tap and die tools storage and easy access.

ILLUSTRATION	RATCHETING TOOLS IN SET	ITEM NO.	PRICE
<p data-bbox="121 409 665 436">5 PC RATCHETING TAP AND DIE TOOL SET</p> 	<p data-bbox="737 409 1114 579">Adjustable Tap Socket #6 - 1/4 Adjustable Tap Socket 1/4 - 1/2 1" Hex Die Socket Adapter Ratcheting Handle Sliding Handle for Tap Sockets</p>	<p data-bbox="1295 409 1409 436">RTDTS-5</p>	<p data-bbox="1458 409 1528 436">52.48</p>

ADJUSTABLE TAP AND REAMER WRENCHES

TT-77

ICS USA

GENERAL PURPOSE

OFFSET HANDLE

Offset Handle Adjustable Tap and Reamer Wrenches are made for general purpose work. They adjust by evenly turning two knurled handles.

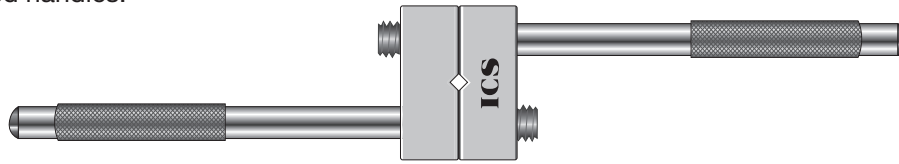

OVERALL LENGTH	CAPACITY					ITEM NO.	PRICE
	SCREW EXTRACTOR	HAND TAPS	MACHINE TAPS	PIPE TAPS	HAND REAMERS		
7	#1 - 5	1/16 - 1/2	0 - 14	1/8	11/64 - 7/16	TWOH5	11.32

ADJUSTABLE TAP AND REAMER WRENCHES

ICS USA

GENERAL PURPOSE

STRAIGHT TYPE

Solid Die Cast Adjustable Tap and Reamer Wrenches are solidly built for a lifetime of industrial service under normal conditions. Size 0 to 7 wrenches have solid handles, one of which is forged integral with the body. The other handles turn for size adjustment. Size 7-1/2 to 8 wrenches have solid handles which are removable. One handle turns for size adjustment.

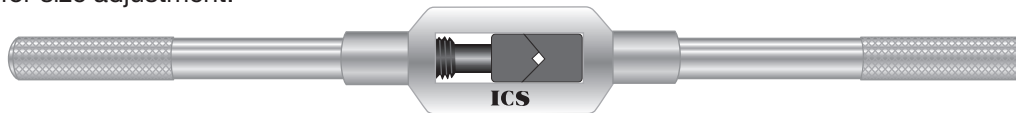

OVERALL LENGTH	CAPACITY						ITEM NO.	PRICE
	SCREW EXTRACTOR	HAND TAPS	MACHINE TAPS	PIPE TAPS	HAND REAMERS	ADJUSTABLE HAND REAMERS		
6-1/2	#1-3	1/16 - 1/4	0 - 14	-	1/8 - 21/64	8A - A	TW-0	9.18
9	#4	1/16 - 3/8	0 - 14	-	1/8 - 25/64	8A - C	TW-4	12.84
10	#5	5/32 - 1/2	7 - 14	1/8 - 1/4	11/64 - 7/16	8A - F	TW-5	15.52
13-1/2	#6	5/32 - 3/4	7 - 14	1/8 - 1/4	11/64 - 41/64	8A - G	TW-6	20.00
17-1/4	#7	1/4 - 1	-	1/8 - 1/2	9/32 - 23/32	3A - J	TW-6.5	28.36
19	#7	1/4 - 1-1/8	-	1/8 - 3/4	9/32 - 29/32	3A - K	TW-7	35.18
31	#8	1/2 - 1-3/8	-	1/8 - 1	3/4 - 1-5/32	B - L	TW-7.5	96.44
40	#10	3/4 - 1-5/8	-	3/8 - 1-1/4	37/64 - 1-11/32	C - M	TW-8	147.00
54	#11-12	1 - 2-1/2	-	3/4 - 2	7/8 - 2-1/8	J - O	TW-9.5	177.94

ADJUSTABLE TAP AND REAMER WRENCHES

ICS USA

HEAVY DUTY

STRAIGHT TYPE

Heavy Duty Solid Die Cast Adjustable Tap and Reamer Wrenches are built for a lifetime of industrial service even under hard use. All sizes have solid handles, one of which is forged integral with the body. The other handle turns for size adjustment.

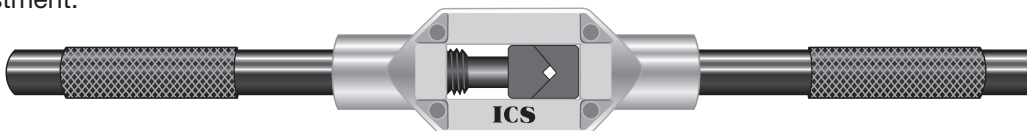

OVERALL LENGTH	CAPACITY					ITEM NO.	PRICE
	SCREW EXTRACTOR	HAND TAPS	MACHINE TAPS	PIPE TAPS	HAND REAMERS		
9	#5	5/32 - 1/2	4 - 14	1/8	11/64 - 7/16	TWHD5	17.16
15	#6	1/4 - 3/4	-	1/8 - 1/4	11/16 - 41/64	TWHD6	29.40
19	#7	1/2 - 1-1/8	-	1/8 - 3/4	3/4 - 29/32	TWHD7	52.30

T-HANDLE TAP WRENCHES

ICS USA

GENERAL PURPOSE

FIXED JAWS

Plain Type

T-Handle Tap Wrenches are designed for hand tapping. They also can be used with reamers, drills, and screw extractors. T-Handle may be slipped from side to side for complete turns in close quarters or be extended full length in either direction for more leverage.

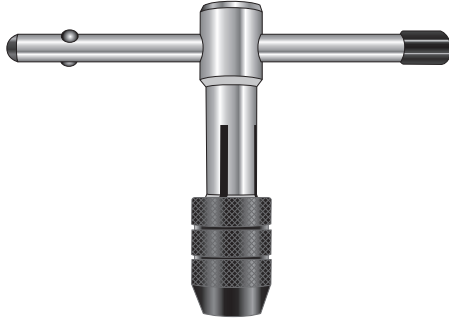

TAP CAPACITY	ITEM NO.	PRICE
#0 - 1/4	TTW-1	5.22
#12 - 5/16	TTW-2	-
1/4 - 1/2	TTW-3	9.14

3/8" Square Drive Type

T-Handle Tap Wrenches with 3/8" square drive are designed with a removable handle to insert a 3/8" ratchet or extension when desired. All other features are same as regular T-Handle Tap Wrenches.

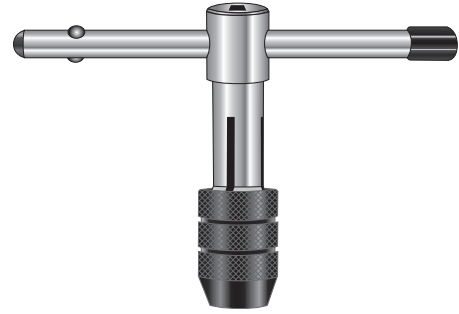

TAP CAPACITY	ITEM NO.	PRICE
1/4 - 1/2	TTWSD3	13.58

T-HANDLE TAP WRENCHES

ICS USA

HEAVY DUTY

FIXED JAWS

Piloted Spindle

T-Handle Tap Wrenches with a piloted spindle are designed for threading a drilled hole manually on a drill press or lathe, without moving the work piece from set-up.

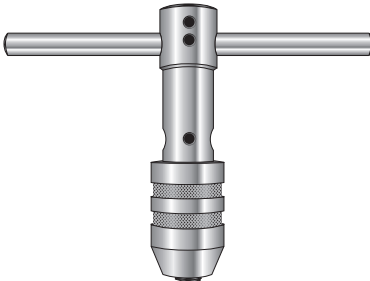

TAP CAPACITY	ITEM NO.	PRICE
#0 - 1/4	TTWP-1	16.24
1/4 - 1/2	TTWP-2	23.72
1/2 - 3/4	TTWP-3	54.66

Ratchet Type

T-Handle Tap Wrenches with a ratchet and slip handle are designed with a selector switch for left, right, or rigid operation.

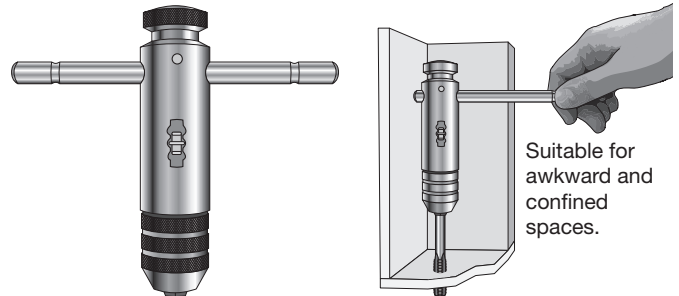

Suitable for awkward and confined spaces.

TAP CAPACITY	ITEM NO.	PRICE
#0 - #8	TTWR-1	18.32
#8 - 1/4	TTWR-2	19.98
1/4 - 1/2	TTWR-3	24.28

DIE STOCKS

TT-79

ICS USA

HEAVY DUTY

THREE SCREW TYPE

'Die Cast Steel' and 'Heavy Duty Steel' Three-Screw Type Solid Die Stocks are designed to hold round adjustable dies of any construction. (Open style adjustment or internal screw adjustment type).

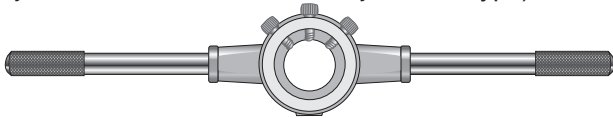

SIZE OF DIE	LENGTH	ITEM NO.	PRICE
DIE CAST STEEL			
13/16	7	DSH052	7.88
1	8	DSH100	7.88
1-1/2	12-1/2	DSH132	14.56
2	15	DSH200	26.82
2-1/2	20	DSH232	48.20
3	22	DSH300	87.68
HEAVY DUTY STEEL			
4	29	DSH400	152.26
5	33	DSH500	288.76

Combination Adjustable Guide Solid Die Cast Stocks are designed to hold hexagon or round dies. Three jaw, self-centering adjustable guides provide easy starting and accurate threading.



SIZE AND TYPE OF DIE	LENGTH	ITEM NO.	PRICE
1" Hex or 1" Rd	9-7/8	DSAG100	17.20
1-1/2" Hex or 1-7/16" Rd	14-1/8	DSAG132	31.12
1-7/8" Hex	23	DSAG156	54.84

HEXAGON DIE ADAPTERS

SPECIAL PURPOSE

Hexagon Die Adapters convert round dies to hexagon dies when space limitations rule out use of die stocks. Round dies easily lock in position with two set screws.

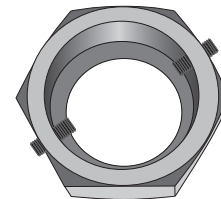

GENERAL PURPOSE

Solid Die Cast Stocks are designed to hold 1" hexagon dies or 1" round dies. Dies easily lock in position with one set screw. Precision molded for accurate threading.



SIZE AND TYPE OF DIE	LENGTH	ITEM NO.	PRICE
5/8" Hex	5	DSE040	8.40
1" Hex or 1" Round	9	DSE100	9.50

SIZE OF DIE	LENGTH	ITEM NO.	PRICE
13/16	1-1/2	HDA052	11.00
1	1-1/2	HDA100	11.06
1-1/2	2	HDA132	13.52
2	2-1/2	HDA200	19.82

FLOATING ROUND DIE HOLDERS

SPECIAL PURPOSE

Floating Round Die Holders are designed for short or medium run threading of shafts on lathes, milling machines, and tapping heads. Main body is counterbored for chip clearance. Through hole design can be used to rethread studs. Die holders must be indicated in that they do not self center and are not designed for CNC. They are also known as Round Die Holders.

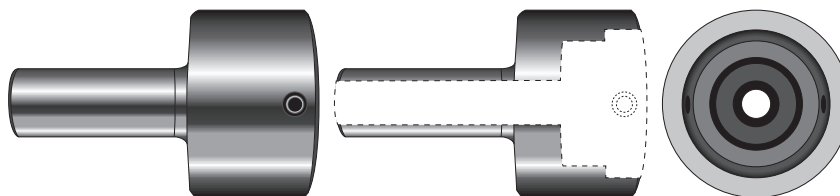

SIZE OF DIE	SHANK DIE	OVERALL LENGTH	THREAD RANGE	THROUGH HOLE IN SHANK	ITEM NO.	PRICE
13/16	1/2	3	#0 to 3/8	25/64	FDH052	28.52
1	1/2	3	#0 to 3/8	25/64	FDH100	28.52
1-1/2	3/4	3	1/4 to 3/4	37/64	FDH132	39.60

SCREW PITCH GAUGES

ICS USA

SPECIAL PURPOSE

Screw Pitch Gauges quickly identify and measure V, Unified, American National 60° threads and Metric threads. Blades are clearly marked with thread size.

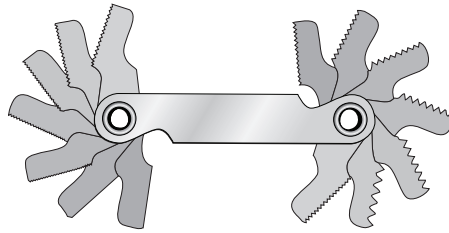

GAUGE RANGE	ITEM NO.	PRICE
9 to 40 Fractional	SPG-F	7.92
.45 to 2.5M Metric	SPG-M	7.92

DIE STOCK SCREWDRIVER

ICS USA

SPECIAL PURPOSE

PRECISION GROUND

Die Stock Screwdriver is designed for adjusting set screws on Die Stocks and Round Adjustable Dies. They have a plastic handle with a high carbon blade and are used in ICS tap and drill sets.

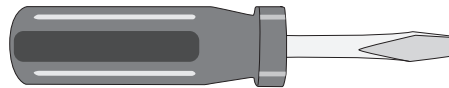

BLADE SIZE	ITEM NO.	PRICE
9 to 40 Fractional	S-DS-008X216	2.10

TAP GUIDE

ICS USA

SPECIAL PURPOSE

PRECISION GROUND

A Tap Guide is designed to start every tap straight in the hole. It has a 3/16" diameter reversible tension pin for male or female hole centering of tap. 1/2" diameter shank is hardened and knurled for easy handling. Tension spring is adjustable.



SHANK	TENSION PIN	ITEM NO.	PRICE
1/2	3/16	TG032	9.66

HEX DIE STOCK TAP ADAPTER

ICS USA

SPECIAL PURPOSE

PRECISION GROUND

Hex Die Stock Tap Adapter is designed to drive 1/4" - 1/2" hand taps with 1" hex die stocks. Adapter has 4 square size holes to accept end of 1/4" to 1/2" taps.

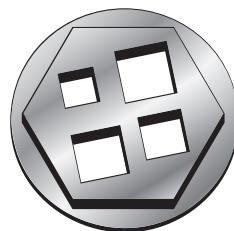

TOP VIEW



SIDE VIEW

ITEM NO.	HEX DIAMETER ACROSS FLATS	TAP CAPACITY	PRICE
HDSTA032	1"	1/4 - 1/2	5.78

THREAD BOX AND TAP SET

ICS USA

SPECIAL PURPOSE

Thread Box and Tap Sets are designed to make sure-holding threads on wood dowels and matching thread hole in wood. Handy set for woodworking and maintenance departments. Each wood threading set contains thread box and matching tap. Handy for threading, rethreading or tapping many wood furnishings. Perfect for the DIYer.

Thread Box - Top View

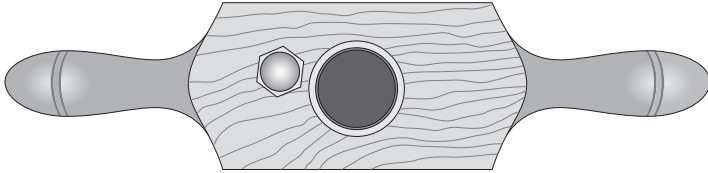

Thread Box - 3/4 Profile View

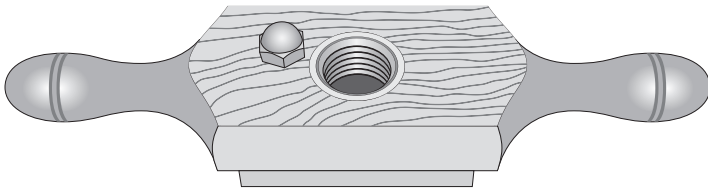

Top

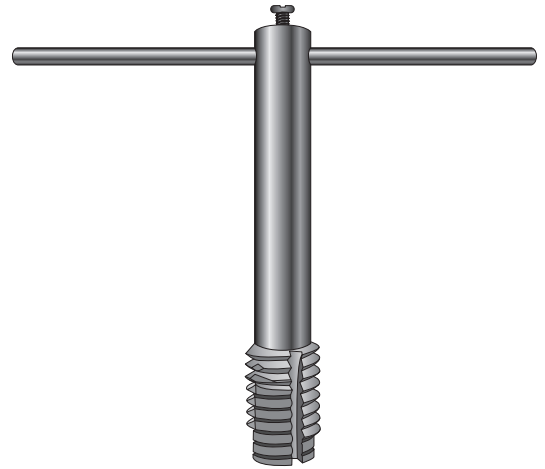

FOR USE WITH	SET CONTAINS	ITEM NO.	PRICE
1/2" Dowel Rod	1 each: tap and thread box	WTS032	48.30
3/4" Dowel Rod	1 each: tap and thread box	WTS048	51.82
1" Dowel Rod	1 each: tap and thread box	WTS100	55.24

EXAMPLES OF USE

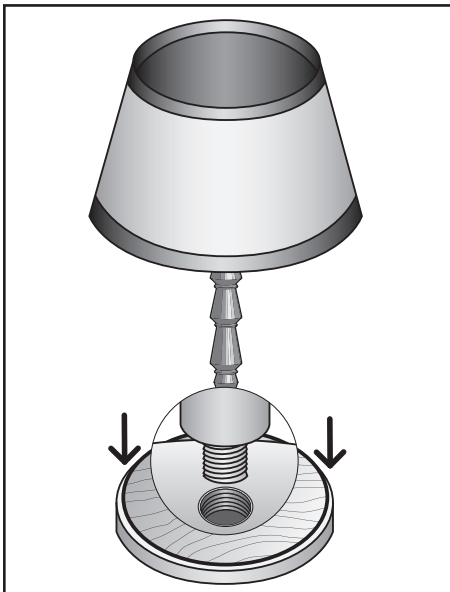

1. Threading and/or tapping wooden lamps.

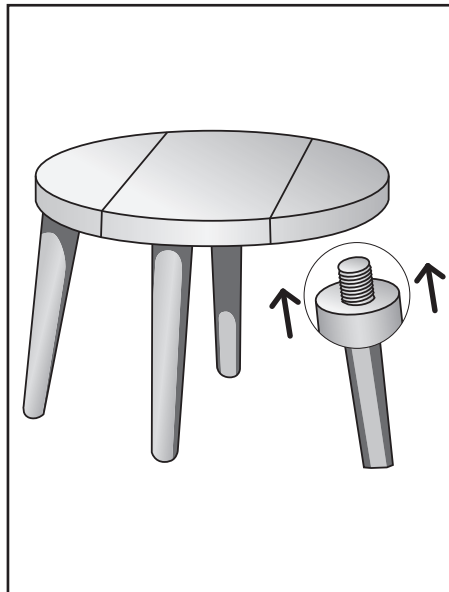

2. Threading and/or tapping stools and chairs.

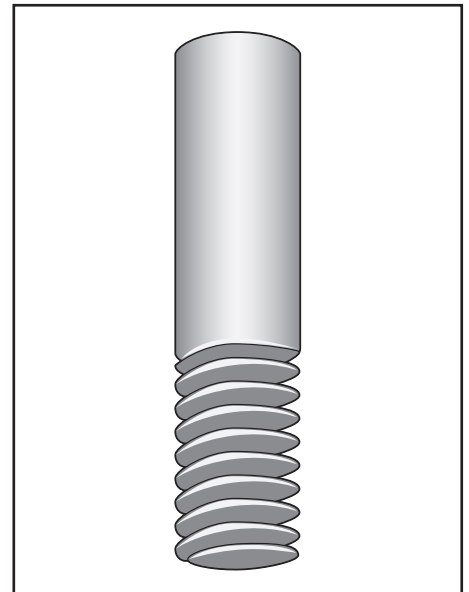

3. Threading or rethreading broomstick/mop handles.

TOOL STEEL
COMBINATION VALVE CORE TOOL

ICS WIS

SPECIAL PURPOSE

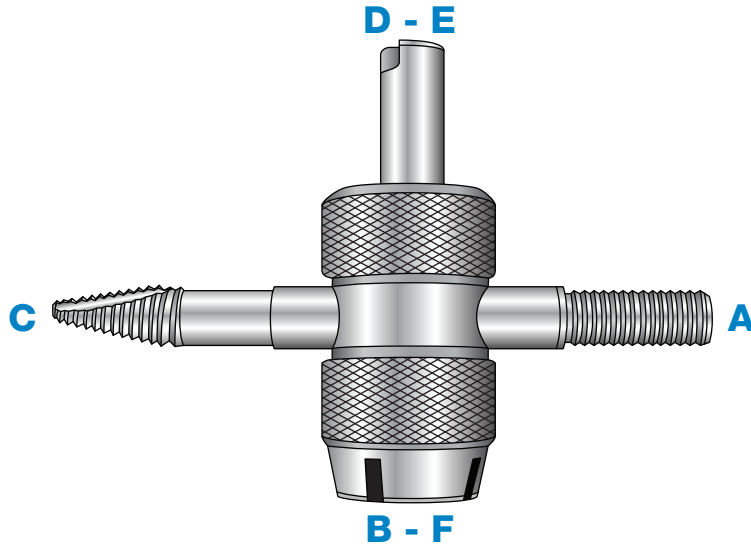

The Combination Valve Core Tool was designed to be a 6 in 1 valve tool.

USES

- (A) Rethreading inside of a valve stem
- (B) Rethreading outside of a valve stem
- (C) A screw extractor to remove valve cores even if shoulders are broken
- (D) Removal of valve cores
- (E) Insertion of valve cores
- (F) For use as a T-handle to pull tire valve into rim hole

A handy tool for any mechanic. It is made of tool steel for long life and durability.

ITEM NO.	DESCRIPTION	PRICE
CVCT	6 in 1 Combination Valve Core Tool	3.14

ICS CUTTING TOOLS, INC
511 MAIN STREET • CASCO, WI 54205-0125 USA



DISTRIBUTED BY:

SCAN TO OPEN THE WEB SITE

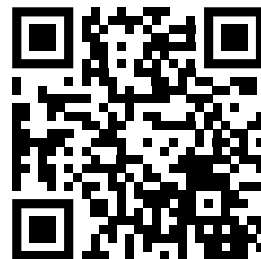

(920) 837-2526 • FAX (920) 837-2530
www.icscuttingtools.com • info@icscuttingtools.com