



# 2012/2013 TOOL CATALOGUE

Industry's Source for Drywall Tools & Accessories





Wallboard Trim & Tool Inc. is celebrating 15 years of supplying quality Tools and Accessories for the Wall and Ceiling Industry across Canada.

Our goal is to provide an extensive product offering, top notch service, and prompt order processing.

Wallboard Trim & Tool Inc. proudly features



Our own line of products designed for the contractor market.

■	<b>JOINT KNIVES, TROWELS, TEXTURE TROWELS</b>	<b>1-2</b>
■	<b>TAPING KNIVES, MUD PANS, VARIOUS TAPING ACCESSORIES</b>	<b>3-4</b>
■	<b>BANJOS, TAPE PULLERS, TRIM-TEX AUTO MIXER AND HOPPER</b>	<b>5</b>
■	<b>MIXING PADDLES, SCRAPERS, ACCESS PANELS</b>	<b>6</b>
■	<b>TEXTURE MACHINES, STUCCO TOOLS</b>	<b>7</b>
■	<b>HOMAX TEXTURES, TRIM-TEX ADHESIVES</b>	<b>8</b>
■	<b>TRIM-TEX ADHESIVES, NEVER-MISS, CB DUST MASKS</b>	<b>9</b>
■	<b>ABRASIVES: SANDPAPER ROLLS, BLOCKS, SCREENS, DIE-CUT SHEETS</b>	<b>10-11</b>
■	<b>FULL CIRCLE SANDINGS PRODUCTS</b>	<b>12</b>
■	<b>SANDING HEADS AND POLES</b>	<b>13</b>
■	<b>MESH TAPE, FIRE TAPE, ROLL-ON BEAD, BARRICADE TAPE, CHALK</b>	<b>14</b>
■	<b>COMPOUND TUBES, WIPERS AND APPLICATORS, EYELAGS</b>	<b>15</b>
■	<b>SUSPENDED CEILING TOOLS AND ACCESSORIES</b>	<b>16</b>
■	<b>TOOLS, BOARD LIFTERS, SHARK SAWS</b>	<b>17-18</b>
■	<b>UTILITY KNIVES AND BLADES, OLFA PRODUCTS</b>	<b>19</b>
■	<b>TAPETECH AUTOMATIC TAPING TOOLS</b>	<b>20-21</b>
■	<b>HAMMERS, HATCHETS, DRYWALL BACKING PRODUCTS</b>	<b>22</b>
■	<b>ROTOZIP PRODUCTS AND DRYWALL CLIPS</b>	<b>23</b>
■	<b>LEATHER AND NYLON POUCHES AND ACCESSORIES</b>	<b>24-25</b>
■	<b>STAPLERS AND STAPLES</b>	<b>26</b>
■	<b>NORTH SAFETY PRODUCTS</b>	<b>27</b>
■	<b>BENCHES, PLANKS AND LADDERS</b>	<b>28-29</b>
■	<b>SCAFFOLDS AND DRYWALL DOLLIES</b>	<b>30-33</b>
■	<b>JOB SITE DISPOSAL BINS</b>	<b>34</b>
■	<b>STILTS, SCHEMATICS AND PARTS LIST</b>	<b>35-37</b>
■	<b>DRYWALL PANEL LIFTER</b>	<b>38</b>
■	<b>PRODUCT – UPC BAR CODES</b>	<b>39-40</b>



**Circle Brand DuraGrip Putty Knife with Hammer Head**

Fully hardened high carbon steel blade, precision ground with mirror finish. Comfortable SoftGrip handle. Solid metal hammer end to set protruding drywall nails and embed beads.

**Carbon Steel Blade**

<b>CB3084</b>	4" Flex Joint Knife	12 /ctn.
<b>CB3085</b>	5" Flex Joint Knife	12 /ctn.
<b>CB3086</b>	6" Flex Joint Knife	12 /ctn.



**Circle Brand Nylon Handle Taping Knife with Hammer Head**

Fully hardened steel blades, precision ground with mirror finish. Heat treated. Lacquer coated. Solid metal hammer head to set protruding drywall nails.

**Carbon Steel Blade**

<b>CB3074</b>	4" Flex Joint Knife	12 /ctn.
<b>CB3075</b>	5" Flex Joint Knife	12 /ctn.
<b>CB3076</b>	6" Flex Joint Knife	12 /ctn.

**Stainless Steel Blade**

<b>CB3094</b>	4" Flex Joint Knife	12 /ctn.
<b>CB3095</b>	5" Flex Joint Knife	12 /ctn.
<b>CB3096</b>	6" Flex Joint Knife	12 /ctn.



**Kraft All Stainless Steel Joint Knife** New

Flexible drywall knife. One piece stainless steel blade and handle. Blade ground for "broken-in" feel.

**Stainless Steel Blade**

<b>KFDW729</b>	4" Joint Knife	5/ctn.
<b>KFDW730</b>	5" Joint Knife	5/ctn.
<b>KFDW733</b>	6" Joint Knife	5/ctn.



**Kraft All Stainless Steel Joint Knife with Sure-Grip Handle** New

Flexible drywall knife. One piece stainless steel blade and handle. Blade ground for "broken-in" feel. Comes with comfortable Sure-Grip Handle

**Stainless Steel Blade**

<b>KFDW729PF</b>	4" Joint Knife	5/ctn.
<b>KFDW730PF</b>	5" Joint Knife	5/ctn.
<b>KFDW733PF</b>	6" Joint Knife	5/ctn.



**Circle Brand Soft Grip Plaster Trowel**

Comfortable SoftGrip handle. Flexible, tempered and polished spring steel blade. Aluminum alloy shank.

**Carbon Steel Blade**

<b>CB16200</b>	4 1/2" x 11 1/2"	6 /ctn.
----------------	------------------	---------

**Stainless Steel Blade**

<b>CB16210</b>	4 1/2" x 11"	12 /ctn.
<b>CB16211</b>	4 1/2" x 11 1/2"	12 /ctn.
<b>CB16212</b>	4 1/2" x 12"	12 /ctn.
<b>CB16214</b>	4 1/2" x 16"	12 /ctn.



**Circle Brand Plaster Trowel with Wooden Handle**

Flexible, tempered and polished spring steel blade. Aluminum alloy shank with smoothly curved wooden handle.

**Stainless Steel Blade**

<b>CB16190</b>	4 1/2" x 11"	6 /ctn.
<b>CB16191</b>	4 1/2" x 11 1/2"	6 /ctn.
<b>CB16192</b>	4 1/2" x 14"	6 /ctn.

**High Carbon Steel Blade**

<b>CB16260</b>	4 1/2" x 11"	12 /ctn.
<b>CB16261</b>	4" x 12"	6 /ctn.
<b>CB16262</b>	4" x 14"	6 /ctn.
<b>CB16263</b>	4" x 16"	12 /ctn.

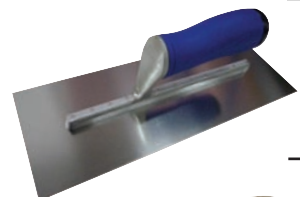

**Circle Brand Plaster Trowel with Curved Blade**

Designed to feather and taper drywall joints. Comfortable SoftGrip handle.

**Stainless Steel Blade**

<b>CB16265</b>	4 1/2" x 12"	6 /ctn.
<b>CB16266</b>	4 1/2" x 14"	6 /ctn.



**Circle Brand PRO Plaster/Cement Trowel**

Made of high-carbon steel (H/C). Curved wooden handle. Precision ground edges ready for immediate use.

**High Carbon Steel Blade**

<b>CB16235</b>	4 1/2" x 11"	6 /ctn.
<b>CB16236</b>	4" x 12"	6 /ctn.
<b>CB16237</b>	4" x 14"	6 /ctn.
<b>CB16238</b>	4" x 16"	6 /ctn.

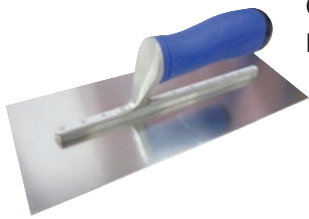

**Circle Brand PRO Plaster Trowel**

Made of stainless steel (S/S) or high-carbon steel (H/C). SoftGrip handle. Precision ground edges ready for immediate use.

**Stainless Steel Blade**

- CB16230** 4½" x 11" 6 /ctn.
- CB16231** 4½" x 11½" 6 /ctn.
- CB16232** 4½" x 14" 6 /ctn.

**High Carbon Steel Blade**

- CB16233** 4½" x 11" 6 /ctn.
- CB16234** 4½" x 11½" 6 /ctn.



**Bucket Scoop** *New*

Radius on blade allows total removal of drywall mud, grout, stucco and cement from bucket or pail. 6½" Stainless Steel blade with Tuff-Grip handle.

- WT05002** Tuff-Grip Bucket Scoop 6 /ctn.

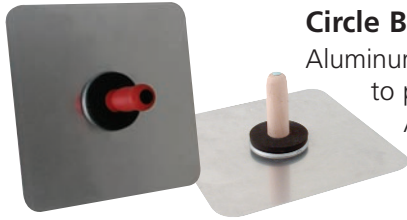

**Circle Brand Aluminum Plaster Hawk**

Aluminum constructed with circular grooves to prevent material from sliding. Available with a wooden or ErgoGrip handle and callous preventers.

- CB16271** 10" x 10" 6 /ctn.
- CB16270** 13" x 13" 6 /ctn.
- CB16272** 13½" x 13½" 6 /ctn.
- CB16273** 13" x 13" with ErgoGrip Handle 6 /ctn.



**Spray Shield**

Aluminum blade and mounting used to keep texture spray material and paint off flooring, doors and window jambs. Ideal for acoustical ceilings. ½" lip designed to catch "run-off".

- WT58002** 36" (W) x 8" (H) Spray Shield with 18" Handle 6 /ctn.



**Paint Shield**

Aluminum mounting holds a flexible 24" (W) x 10" (H) plastic blade. Keeps paint and other materials off flooring, doors, windows, jambs, etc. Ideal for acoustical ceiling sprays/ applications.

- WT88009** 24" Paint Shield 12 /ctn.



**Lexan Knockdown Knife** *New*

Clean polycarbonate blade that is flexible and durable. Ideal for drywall, EIFS, acoustical work and a wide variety of textures. Has a 6" handle with female threaded end for an extension pole.

- CB14086** 12" x 12" Lexan Knife 6 /ctn.
- CB14083** 18" x 12" Lexan Knife 6 /ctn.
- CB14084** 24" x 12" Lexan Knife 6 /ctn.
- CB14085** 36" x 12" Lexan Knife 6 /ctn.



**Homax Ceiling Texture Scraper** *New*

A specially designed scraping tool that removes unwanted popcorn ceiling texture. A typical 10' x 10' ceiling can be completed in 30 minutes or less. Unique bag attachment captures texture as it is removed. Connect to standard extension handle. Special design prevents gouging of ceiling surface.

- HO6100** Ceiling Texture Scraper 6 /ctn.





### Circle Brand Drywall Corner Trowels

Flexible, tempered stainless steel blade for finishing inside and outside corners.

#### Stainless Steel Blade

<b>CB16185</b>	2½" x 4" 103° to 90° Inside Corner Trowel	6/ctn.
<b>CB16186</b>	2½" x 4" 80° to 90° Outside Corner Trowel	10/ctn.



### Cool Grip II Bullnose Drywall Corner Trowels New

Flexible, Stainless steel corner trowels with Cool Grip II handles designed to finish 90° Inside and Outside Bullnose corners.

#### Bullnose Corner Trowels

<b>CB16184</b>	Inside Bullnose Trowel 2" x 4½"	6/ctn.
<b>CB16187</b>	Outside Bullnose Trowel 2" x 4½"	6/ctn.



### Circle Brand True Fit Corner Trowel

Creates clean sharp corners. 3½" blade, 5" plastic handle, adjustable from 90° to 135°.

<b>CB010</b>	True Fit Corner Trowel	6/ctn.
--------------	------------------------	--------



### Circle Brand Swimming Pool Trowel

Flexible Stainless steel blade, tempered and shaped, with smooth wooden handle to allow bending to the radius of almost any pool.

<b>CB16180</b>	4" x 14" Trowel	12/ctn.
----------------	-----------------	---------



### Circle Brand Plastic Smoothing Trowel

Durable all plastic construction with an easy grip handle. Ideal for smoothing exterior stucco and specialty coating materials.

<b>CB16181</b>	5½" x 11" Plastic Trowel	12/ctn.
----------------	--------------------------	---------



### Rubber Float

Smooth moulded plastic handle with durable rubber base. Sponge rubber pad with epoxy edge beading.

<b>WT88007</b>	4" x 9½" Rubber Float	6/ctn.
----------------	-----------------------	--------



### Circle Brand Corner Pro Wipedown Knife

Flexible rubber knife for finishing and cleaning inside and outside angles, especially Bullnose beads. Can be used by hand or pole by threading pole into handle end.

<b>CB3077</b>	Corner Pro Wipedown Knife	12/ctn.
---------------	---------------------------	---------



### Circle Brand Hand Sander

Durable injection moulded plastic handle and base. Clamp design allows for several sheets of sandpaper to be held at one time.

<b>CB15013</b>	Hand Sander Plastic with Metal Clamp	10/ctn.
----------------	---	---------



### Circle Brand Inside Corner Roller

Applies drywall compound to inside corners, embedding drywall tape, comes with threaded end to insert pole.

<b>ST0230</b>	Inside Corner Roller	12/ctn.
---------------	----------------------	---------



### Curved Blade Wipedown Taping Knife

Professional quality blue spring steel blade with 16" slant-cut wooden handle. Offset design allows for better control and pressure.

<b>CB14081</b>	Wipedown Taping Knife w/ 18" Blade & 16" Handle	6/ctn.
<b>CB14082</b>	Wipedown Taping Knife w/ 24" Blade & 16" Handle	6/ctn.



**Circle Brand Broad Knife**

Blue spring steel blade with shims attached to a 14" tube handle.

<b>CB14040</b>	7" Broad Knife	6 /ctn.
<b>CB14041</b>	9" Broad Knife	6 /ctn.

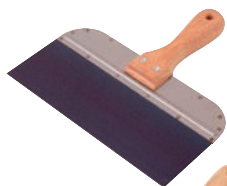

**Circle Brand Taping Knife**

Flexible, tempered steel blade with strong steel back. Available in SoftGrip or wooden handles. High quality blue steel or stainless steel blades.

**Blue Steel Blade – Wood Handle**

<b>CB14051</b>	8" Taping Knife	12/ctn.
<b>CB14052</b>	10" Taping Knife	12/ctn.
<b>CB14053</b>	12" Taping Knife	12/ctn.
<b>CB14054</b>	14" Taping Knife	12/ctn.



**Stainless Steel Blade – Wood Handle**

<b>CB14061</b>	8" Taping Knife	12/ctn.
<b>CB14062</b>	10" Taping Knife	12/ctn.
<b>CB14063</b>	12" Taping Knife	12/ctn.
<b>CB14064</b>	14" Taping Knife	12/ctn.



**Stainless Steel Blade – Rubber Grip**

<b>CB14071</b>	8" Taping Knife	12/ctn.
<b>CB14072</b>	10" Taping Knife	12/ctn.
<b>CB14073</b>	12" Taping Knife	12/ctn.
<b>CB14074</b>	14" Taping Knife	12/ctn.



**Cool Grip II Taping Knife**

Stainless steel blade, Cool Grip II handle reduces hand moisture and hand fatigue while improving your grip. Feel the difference!

<b>CB14075</b>	6" S/S Taping Knife	6 /ctn.
<b>CB14076</b>	8" S/S Taping Knife	6 /ctn.
<b>CB14077</b>	10" S/S Taping Knife	6 /ctn.
<b>CB14078</b>	12" S/S Taping Knife	6 /ctn.
<b>CB14079</b>	14" S/S Taping Knife	6 /ctn.



**Circle Brand Mud Pan with 2 Blades**

Professional quality, polyethylene plastic pan with double metal blades.

<b>CB15005</b>	12" Plastic Mud Pan	12/ctn.
----------------	---------------------	---------



**Circle Brand Heli-Arc Stainless Steel Mud Pan**

Heavy Gauge, stainless steel with heli-arc welded corners and water tight construction. Tapered ends and sides.

<b>CB15007</b>	12" Heli-Arc Mud Pan	6/ctn.
<b>CB15008</b>	14" Heli-Arc Mud Pan	6/ctn.

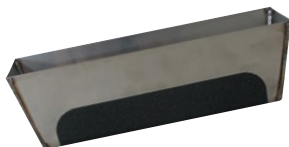

**Heli-Arc No-Slip Grip Stainless Steel Mud Pan**

Stainless steel mud pan with tapered ends and sides. Smooth contoured bottom fits naturally in hand.

<b>CB15000</b>	10" No-Slip Grip Mud Pan	6/ctn.
<b>CB15001</b>	12" No-Slip Grip Mud Pan	6/ctn.
<b>CB15002</b>	14" No-Slip Grip Mud Pan	6/ctn.



**Circle Brand Tape Reel**

All steel construction. Holds 500' of tape with handy belt clip.

<b>CB15010</b>	Drywall Tape Reel	6 /ctn.
----------------	-------------------	---------



**Mud Pan and Tape Holder**

Aluminum, lightweight construction. Mud pan hooks to belt to stay hands-free. Hook below pan holds a 500' roll of joint tape. *Mud pan sold separately.*

<b>CB15011</b>	Mud Pan and Tape Holder.	6/ctn.
----------------	--------------------------	--------

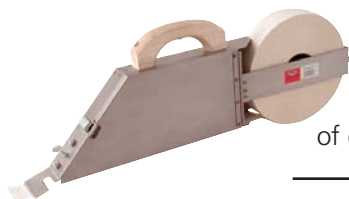

**Universal Banjo**

Stainless steel construction with thumb screw for mud adjustment. Holds 500' roll of drywall tape. For either left or right hand use.

**ST0010** Universal Stainless Steel Banjo. 1/ctn.



**Homax Banjo Drywall Taping Tool**

Plastic taping tool applies mud and drywall tape in one step. Prevents future blistering by maintaining consistent mud thickness. Features adjustable mud control knob and tape tracking wheels. Holds up to 500' tape rolls.

**HO6500** Banjo Drywall Taping Tool. 1/ctn.



**Circle Brand Tape Puller**

Tape Puller dispenses the correct amount of compound to joint tape for quick and easy application. Attach Tape Puller to a 5 gallon bucket. Reduces work time with little clean-up involved.

**CB001** Tape Puller 1/ctn.  
**CB001A** Replacement Pin  
**CB001B** Replacement Roller



**Trim-Tex Auto Mixer** New

Hands free heavy duty power drill mixes drywall compounds and exterior acrylic finishes, creating consistently creamy finishing material. Comes with power drill, stainless steel mounting bracket, mixing paddle and 5 gallon bucket.

**TT0751** Auto Mixer 1/ctn.

*\*Pricing found in Trim-Tex price list.\**



**Trim-Tex Pro Series Cornerbead Rollers** New

Designed to install Trim-Tex Mud Set beads. Two different rollers; 1 roller installs 90° Mud Set Rigid and Bullnose beads, the other installs the splayed 45° versions of these products.

**TT0385** Pro Series 90° Roller 1/ctn.  
**TT0386** Pro Series Splayed Roller 1/ctn.

*\*Pricing found in Trim-Tex price list.\**



**Trim-Tex Pro Series Hopper & Stand**

Hopper saves compound and reduces mess. Can be used for vinyl and paper/metal bullnose, regular and splayed versions of each type of corner. Made of rugged polypropylene that resists dents.

**TT0390** Pro Series Hopper only 1/ctn.  
**TT0391** Pro Series Hopper Stand only. 1/ctn.  
**TT0390I** Replacement plastic inserts.  
**TT0390R** Replacement rubber inserts.

*\*Pricing found in Trim-Tex price list.\**



**Hand Mixers**

All steel construction bonded to a wooden handle. For small batch mud mixing.

**WT42001** 25" Square Head Mixer 6/ctn.  
**WT42002** 37" Semi Round Head 6/ctn.  
**WT42004** 37" Square Head Mixer 6/ctn.



**Wallboard Trim & Tool Inc.**

is now stocking a selection of Marshalltown Tools for the drywall trade. Contact us for a listing of our inventoried product assortment.

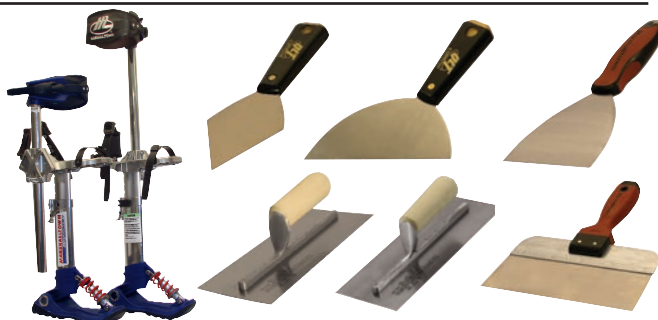

**DISTRIBUTORS OF QUALITY DRYWALL TOOLS & ACCESSORIES**

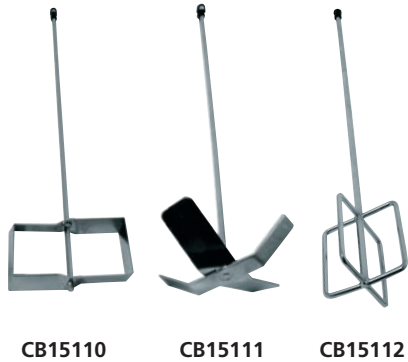

### Circle Brand Mixing Paddles

Mixers for drywall compound, ceiling, wall texture, paint, concrete and mortars.

**CB15110 Quick Mixer**  
36" shaft. Designed to fold and mix material quickly. 10/ctn.

**CB15111 Flat Blade Mixer**  
28" shaft. Angled cross blades help pull water and material from top of the bucket downward. 6/ctn.

**CB15112 Square Blade Mixer**  
28" shaft. Mixes thin-set mortar, grout, sheetrock and concrete products. 6/ctn.



**CB15113 Boomerang Mixer**  
28" heavy duty shaft. Mixes material inward from top to bottom to prevent splashing. 6/ctn.

**CB15114 Three Blade Adjustable Mixer *New***  
24" heavy duty zinc plated steel shaft. Designed to fold various material mixture with no lumping. Comes with three adjustable 5" blades. 6/ctn.

**CB15115 Die Cast Mud Mixer *New***  
30" steel shaft mixer has a die cast head. Rounded pail saver tip designed for better balance while mixing and to keep from scraping bucket bottom that results in foreign particles in mixtures. Ideal for mixing drywall compounds and texturing materials.

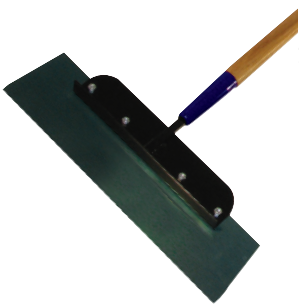

### Floor Scrapers

Scrapers have a 5' steel or wooden handle mounted to a heavy steel bracket. Metal handle has a plastic grip on end.

**Wooden Handle (Heavy Duty) *New***  
**CB4018** 14" Floor Scraper 6/ctn.  
**CB4020** 18" Floor Scraper 6/ctn.  
**CB4019** 14" Replacement Blade  
**CB4021** 18" Replacement Blade

**Steel Handle**  
**CB4008** 7" Floor Scraper 6/ctn.  
**CB4010** 14" Floor Scraper 6/ctn.  
**CB4012** 20" Floor Scraper 6/ctn.  
**CB4009** 7" Replacement Blade  
**CB4011** 14" Replacement Blade  
**CB4013** 20" Replacement Blade

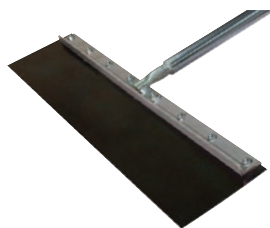

### Wall Scraper

Spring steel blade bolted to aluminum angle mounting attached to 4' steel handle. Blade has right temper for perfect wall cleaning or scraping.

**CB4014** 18" Wall Scraper 6/ctn.  
**CB4016** 24" Wall Scraper 6/ctn.  
**CB4015** 18" Replacement Blade  
**CB4017** 24" Replacement Blade



### Access Panel

- Eliminates costly wall and ceiling repairs.
- Panel has perfect fit of lid and frame for maximum assurance against water.
- Cosmetically desirable when panel must be located in sight.
- Made of long lasting A.B.S. with U.V. stabilizers and can be painted if desired.
- Can be installed on surface or flush mounted.

**AP69** 6" x 9" Panel 6/ctn.  
**AP88** 8" x 8" Panel 6/ctn.  
**AP1414** 14" x 14" Panel 6/ctn.  
**AP1429** 14" x 29" Panel 6/ctn.





### Kraft ProForm® Texture Gun and Hopper

Sprays a variety of materials. Built-in hopper angle easily lets user direct spray for walls and ceilings. Built-in easy grip hopper handle. Remove nozzle and tip for quick and easy cleaning.

**KFPC201** ProForm® Texture Gun and Hopper 1/ctn.

*\*Replacement parts available upon request\**



### Kraft Super-Pro® Texture Gun and Hopper

Sprays a variety of textures and materials. Large 2.5 gallon hopper with built-in control handle has a 40 degree hopper angle for easy spraying. Special orifice adjusting nut makes orifice selection quick and easy. Complete with patented Super-Pro gun cylinder and shut-off valve.

**KFPC301** Super-Pro® Texture Gun and Hopper 1/ctn.

*\*Replacement parts available upon request\**



### Kraft Standard Texture Gun and Hopper

Ideal for spraying walls, ceilings, fireproofing and stucco. Texture gun is made of cast aluminum for long wear and tear. Top handle for control of hopper. The hopper angle is great for walls and ceilings.

**KFPC501** Standard Texture Gun and Hopper 1/ctn.

*\*Replacement parts available upon request\**



### Kraft Standard Texture Spray Machine with Gun, Hopper & Hose

The PC500 compressor and gun will spray and apply a variety of texture coatings. Air and texture material combine at the gun to produce the desired texture. Overhead work is made easy with the built-in angle feature. Compressor includes a 1-horsepower capacitor-start electric motor with manual re-set thermal overload protector. Delivers 6.2 CFM free air at 25 PSI. Comes with Standard Texture Gun and Hopper. (KFPC501).

**KFPC500** Texture unit with Gun, Hopper and Hose. 1/ctn.

*\*Replacement parts available\**

- WT50031** Hose 50'
- WT83015** Pressure Release Valve
- WT83022** Air Filter for Compressor
- WT50032** Female Quick Hose Disconnect
- WT83004** 29" "V-Belt"
- WT83008** Motor Switch
- WT83021** Intake Filter Assembly
- WT83023** Pressure Gauge
- WT83030** Oil Reserve Assembly
- WT83038** Oil Cap
- WT83046** Replacement Wheel

**\*DO NOT USE SYNTHETIC OIL.\***



### Stucco Patch Machine

2 quart capacity (1.893 litre). Used to apply colour coat, acoustic and drywall mud. Used for patching small areas with stucco or plaster to match existing coating.

**WT54050** Stucco Patch Machine 1/ctn.

*\*Manufacturer does not offer warranty\**



### Single Texture Brush

Tampico bristles with hardwood block and handle hole in centre. Flattened single brush measures 8" x 1<sup>3</sup>/<sub>4</sub>" and creates a "crow's foot" pattern.

**WT62012** Single Texture Brush, Tampico, 8" x 1<sup>3</sup>/<sub>4</sub>" 6/ctn.



**Double Texture Brush**

Tampico bristles with hardwood block and handle hole in centre. Flattened double brush measures 8" x 1 3/4" (x2) and creates a "crow's foot" pattern.

**WT62009** Double Texture Brush, Tampico, 8" x 1 3/4" (X2) 6/ctn.



**Standard Round Texture and Jumbo Texture Brushes**

Bristles securely fixed to the rounded base. Contoured block fits your hand comfortably or can be attached to a handle. Excellent for texturing drywall.

**WT62005** Round Texture Brush 4 3/4" Diameter 1/ctn.

**WT62011** Jumbo Texture Brush 5 1/8" Diameter 1/ctn.



**Homax Touch Up**

Repair damaged textures on walls and ceilings with wall spray and acoustical touch up kits.

**HO4105** Wall Spray Touch-up Kit with Pump 6/ctn.

**HO4120** Acoustical Touch-up Kit with Pump 6/ctn.



**Homax Texture Gun and Hopper**

Create your own custom look or match existing spray texture on walls or ceilings.

*\*Gun and Hopper sold separately.\**

**HO4505** 3 Litre Hopper only 6/ctn.

**HO4205** Pro Spray Gun only 6/ctn.



**Homax Pneumatic II Spray Texture Gun with Hopper**

Works with 3/4 hp or larger compressors, also HVLP compatible. Sprays 16 texture patterns including Super Fine Orange Peel.

**HO4630** Pneumatic II Spray Texture Gun with Hopper 4/ctn.



**Homax Spray Textures**

To texture small areas (up to 100 sq. ft.) or to patch existing walls or ceilings that have already been sprayed.

**HO4155** EasyTouch Texture Spray 20 oz. 12/ctn.

**HO4165** Knockdown Texture Spray 20 oz. 12/ctn.

**HO4199** Popcorn Texture Spray 14 oz. 12/ctn.



**Trim-Tex 847™ Spray Adhesive**

High tack, pressure sensitive spray adhesive specifically designed to be used with Trim-Tex vinyl beads. A must for installing Magic Corner, 093V and Hideaway Expansions.

**TT0847** Spray Adhesive (17 oz) 12/ctn.

*\*Pricing found in Trim-Tex price list.\**



**Trim-Tex 848™ Citrus Cleaner**

Designed to remove adhesive overspray from Trim-Tex vinyl beads and other building materials.

**TT0848** Citrus Cleaner (15 oz) 6/ctn.

*\*Pricing found in Trim-Tex price list.\**



### Trim-Tex Spray Adhesive and Texture Prep

Spray a light coat over Trim-Tex beads to significantly increase the bonding power of any texture product. Text II is also a great all-purpose job site adhesive.

**TT0811**    Text II™ Spray Adhesive    12/ctn.  
16.25 oz.

*\*Pricing found in Trim-Tex price list.\**



### Trim-Tex Mud-Max

Designed to improve the strength and adhesive performance of all drywall compounds, textures and plaster products. One gallon treats up to 16 boxes of compound.

**TT0850**    Mud-Max (1 gallon)    24/ctn.  
**TT0851**    Mud-Max (pint)    12/ctn.

*\*Pricing found in Trim-Tex price list.\**



### Trim-Tex #710 Adhesive Caulk

Designed to be a high-quality bead installation adhesive as well as a painter's caulk. Can accept interior latex paints. *For indoor use only.* Use to install Trim-Tex crown mouldings, chair rails and decorative L-beads and other various applications.

**TT0710**    Adhesive Caulk (300 ml)    24/ctn.

*\*Pricing found in Trim-Tex price list.\**



### Circle Brand Heavy-Duty Skeleton Caulk Gun

Heavy-duty uni-rail construction fits both 850 ml and 300 ml size cartridges.

**CB15068**    14" Heavy-Duty    12/ctn.  
Caulk Gun (850 ml)  
**CB15069**    9" Heavy-Duty    24/ctn.  
Caulk Gun (300 ml) New



### The Never-Miss® Finishing System New

Never-Miss® Colour Gel and Final Coat Finishing System is a patented, breakthrough formula designed to enable the drywall professional to consistently achieve a high quality finish with less time, effort and cost.

**The Colouring Gel** dries highly visible; when the surface is sanded, the colour dissipates preventing over sanding. When added to joint compound:

- Provides extreme visibility
- Track job progress
- Self Priming
- Eliminates paint flashing

**Never Miss Final Coat Ultra White Gel** gives a level 5 finish for both smooth and textured surfaces when added to joint compound. Apply by either spraying or roll skimming. As Final Coat dries and cures, it becomes scratch and nick resistant. No priming required.



**ST5001**    Golden Yellow Colouring Gel – 16.9 ounces    12/ctn.  
**ST5002**    Golden Yellow Colouring Gel – 3 ounces    60/ctn.  
**ST5003**    Pacific Blue Colouring Gel – 16.9 ounces    12/ctn.  
**ST5004**    Pacific Blue Colouring Gel – 3 ounces    60/ctn.  
**ST5005**    Final Coat Ultra White Gel – 8 ounces    24/ctn.



### Circle Brand Dust Masks

Ideal for sanding drywall and installing fiberglass insulation. Masks are NIOSH approved N95 for protection against airborne particulates.

**S2000**    Dust / Mist Respirator  
20 masks per box    12 boxes / ctn.  
**S2001**    Respirator with Valve  
10 masks per box    12 boxes / ctn.  
**S2010**    Nuisance Dust Mask  
50 masks per box    20 boxes / ctn.





## SANDING BLOCKS AND SPONGES

### Dual Angle/Grit Sanding Block

40% larger than standard blocks. Features two tapered edges for corner sanding. Radius edges prevent gouging and scuffing of compound.



<b>TT0885</b>	Medium / Fine Grit	Display Box	24/ctn.
<b>TT0885-BULK</b>	Medium / Fine Grit	Bulk Box	100/ctn.
<b>TT0885-IND</b>	Medium / Fine Grit	Individual	24/ctn.
<b>TT0885F</b>	Fine / Fine Grit	Display Box	24/ctn.
<b>TT0885F-BULK</b>	Fine / Fine Grit	Bulk Box	100/ctn.

*\*Pricing found in Trim-Tex Price List\**

### Single Angle Sanding Blocks

40% larger than standard blocks. Radius edge prevents gouging of compound while angled edge prevents unintentional sanding of opposite wall.



<b>TT0888F</b>	Fine Grit	Display Box	24/ctn.
<b>TT0888F-BULK</b>	Fine Grit	Bulk Box	100/ctn.
<b>TT0888F-IND</b>	Fine Grit	Individual	24/ctn.
<b>TT0888M</b>	Medium Grit	Display Box	24/ctn.
<b>TT0888M-BULK</b>	Medium Grit	Bulk Box	100/ctn.
<b>TT0888M-IND</b>	Medium Grit	Individual	24/ctn.

*\*Pricing found in Trim-Tex Price List\**

### Standard Sanding Blocks

Available in Medium and Fine grits. Radius edge prevents unwanted scuffing and gouging of drywall compound.



<b>TT0883F</b>	Fine Grit	Display Box	24/ctn.
<b>TT0883F-BULK</b>	Fine Grit	Bulk Box	180/ctn.
<b>TT0883M</b>	Medium Grit	Display Box	24/ctn.
<b>TT0883M-BULK</b>	Medium Grit	Bulk Box	180/ctn.

*\*Pricing found in Trim-Tex Price List\**

### Detail Sander New

Provides a larger sanding surface. New shape increases grip and feel. Great for inside corners or tight areas.



<b>TT0590</b>	Display Box	12/ctn.
---------------	-------------	---------

*\*Pricing found in Trim-Tex Price List\**

### Sanding Sponges

Flexible sanding pad with fine grit. Easily conforms for perfect detail sanding.



<b>TT0881</b>	Display Box	50/ctn.
<b>TT0881-BULK</b>	Bulk Box	250/ctn.

*\*Pricing found in Trim-Tex Price List\**





## CIRCLE BRAND SANDING PRODUCTS



### Sponge Back Sandpaper Rolls

Aluminum Oxide sanding rolls that lasts 10 times longer than conventional sandpaper. The foam backing decreases friction and allows even contact with all surfaces throughout the sanding process.

<b>SP224</b>	#100 Grit 3.5" x 30' Sponge Back Roll	5/ctn.
<b>SP225</b>	#120 Grit 3.5" x 30' Sponge Back Roll	5/ctn.
<b>SP226</b>	#150 Grit 3.5" x 30' Sponge Back Roll	5/ctn.
<b>SP227</b>	#180 Grit 3.5" x 30' Sponge Back Roll	5/ctn.
<b>SP228</b>	#220 Grit 3.5" x 30' Sponge Back Roll	5/ctn.



### Sandpaper Rolls

Aluminum Oxide paper backed sandpaper is the choice for do-it-yourselfers and contractors for sanding a wide variety of materials, including wood, paint, drywall compound, metal and plastic.

<b>SP080</b>	#80 Grit 3.5" x 150' Roll	5 / ctn.
<b>SP100</b>	#100 Grit 3.5" x 150' Roll	5 / ctn.
<b>SP120</b>	#120 Grit 3.5" x 150' Roll	5 / ctn.
<b>SP150</b>	#150 Grit 3.5" x 150' Roll	5 / ctn.
<b>SP180</b>	#180 Grit 3.5" x 150' Roll	5 / ctn.
<b>SP220</b>	#220 Grit 3.5" x 150' Roll	5 / ctn.



### Diecut Sandpaper Sheets



Pre-cut sanding sheets for finishing drywall. Fits most hand and pole sanders with pre-cut tabs.

<b>SP335</b>	#100 Grit 4 <sup>3</sup> / <sub>16</sub> " x 11 <sup>1</sup> / <sub>4</sub> " Diecut Sandpaper	100 / pk.
<b>SP336</b>	#120 Grit 4 <sup>3</sup> / <sub>16</sub> " x 11 <sup>1</sup> / <sub>4</sub> " Diecut Sandpaper	100 / pk.
<b>SP337</b>	#150 Grit 4 <sup>3</sup> / <sub>16</sub> " x 11 <sup>1</sup> / <sub>4</sub> " Diecut Sandpaper	100 / pk.
<b>SP338</b>	#180 Grit 4 <sup>3</sup> / <sub>16</sub> " x 11 <sup>1</sup> / <sub>4</sub> " Diecut Sandpaper	100 / pk.

### Drywall Sanding Screen Sheets



For sanding joint compound and plaster. Open mesh design resists clogging and extends screen life. Screens are waterproof and can be rinsed for re-use.

<b>SPS100</b>	#100 Grit Sanding Screen	50 / pk.
<b>SPS120</b>	#120 Grit Sanding Screen	50 / pk.
<b>SPS150</b>	#150 Grit Sanding Screen	50 / pk.
<b>SPS180</b>	#180 Grit Sanding Screen	50 / pk.



### Sanding Blocks and Sponges

Ideal for sanding drywall and plaster. Comes in various grits (fine /medium /coarse). Blocks are available in standard, single or dual angled edges. Sanding sponges are also available in both medium and coarse grit. Available in either bulk or display boxes.

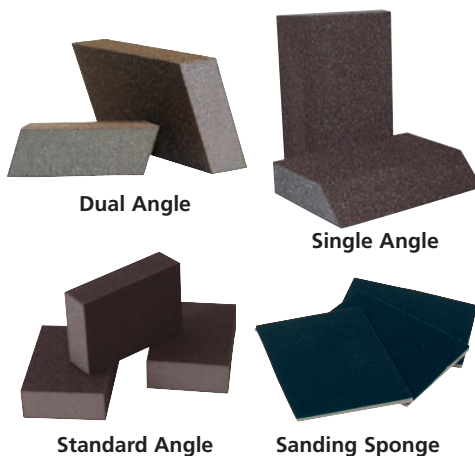

Dual Angle

Single Angle

Standard Angle

Sanding Sponge

<b>SPB01</b>	Standard Medium / Coarse Sanding Block (Display Box)	37/ctn.
<b>SPB02</b>	Standard Medium / Fine Sanding Block (Display Box)	37/ctn.
<b>SPB04</b>	Sanding Sponge Coarse Grit 4.5" x 5.5"	50/ctn.
<b>SPB05</b>	Sanding Sponge Fine Grit 4.5" x 5.5"	50/ctn.
<b>SPB06</b>	Single Angle Fine Grit Block (Display Box)	24/ctn.
<b>SPB07</b>	Single Angle Fine Grit Block (Bulk Box)	100/ctn.
<b>SPB08</b>	Standard Medium / Coarse Sanding Block (Bulk Box)	250/ctn.
<b>SPB09</b>	Standard Medium / Fine Sanding Block (Bulk Box)	150/ctn.
<b>SPB10</b>	Single Angle Medium Grit Block (Bulk Box) <i>New</i>	100/ctn.
<b>SPB11</b>	Single Angle Medium Grit Block (Display Box) <i>New</i>	24/ctn.
<b>SPB12</b>	Dual Angle Block Fine / Medium Grit (Bulk Box) <i>New</i>	100/ctn.
<b>SPB13</b>	Dual Angle Block Fine / Medium Grit (Display Box) <i>New</i>	24/ctn.



**Trigon 180°** Patented replaceable pad and bumper all in one.

**The Radius 360°** Sands large surface areas effortlessly, with no flipping or skipping!

**Pro Handle Adaptor** Adapts to both Radius 360° and Trigon 180°.

**Flex Edge** Perfect for corners, angles and more, with versatile, changeable abrasives for multiple applications. Discover the multi-layer revolution!

**Power Pad** Attaches to Porter Cable 7800 and Flex power sander models, as well as our Radius 360 sanding discs. The performance of a fixed power pad at a fraction of the price.

The Radius 360°		
Description	Code	Per Carton
Sander (Head only)	FC-R360	3/ctn.
Foam Replacement Pad, STD.	FC-RP-STD	3/ctn.
Foam Replacement Pad, THIN	FC-RP-THIN	3/ctn.
Sanding Discs #80 Grit	FC-SD080-5	5 pks/5 discs
Sanding Discs #100 Grit	FC-SD100-5	5 pks/5 discs
Sanding Discs #120 Grit	FC-SD120-5	5 pks/5 discs
Sanding Discs #150 Grit	FC-SD150-5	5 pks/5 discs
Sanding Discs #180 Grit	FC-SD180-5	5 pks/5 discs
Sanding Discs #220 Grit	FC-SD220-5	5 pks/5 discs
Sanding Discs #240 Grit	FC-SD240-5	5 pks/5 discs

Flex Edge		
Description	Code	Per Carton
Sander (Head only)	FC-FLEX	3/ctn.
1/4" Replacement Pad	FC-FE-RP	3/ctn.
Replacement Rubber Pressure Pad	FC-FE-PP	3/ctn.
Flex Foam Fine Grit	FC-FE-FF-FINE	6 pks/5 discs
Flex Foam Medium Grit	FC-FE-FF-MED	6 pks/5 discs
Sanding Sheets #100 Grit	FC-FE100	10 pks/5 discs
Sanding Sheets #150 Grit	FC-FE150	10 pks/5 discs
Sanding Sheets #220 Grit	FC-FE220	10 pks/5 discs

Trigon 180°		
Description	Code	Per Carton
Sander (Head only)	FC-TRI-180	3/ctn.
Foam Rubber Replacement Pad	FC-TRI-RP	3/ctn.
Adapter Plate	FC-T180 PLATE	3/ctn.
Sandpaper Triangles #100 Grit	FC-TG100	5 pks/5 discs
Sandpaper Triangles #150 Grit	FC-TG150	5 pks/5 discs
Sandpaper Triangles #220 Grit	FC-TG220	5 pks/5 discs

Full Circle Accessories		
Description	Code	Per Carton
FX4 Lightweight 48" Aluminum Pole	FC-FX4	6/ctn.
PRO Handle Adapter for Radius 360° and Trigon 180°	FC-PRO-H	3/ctn.
POWER PAD for Porter Cable Vacuum Sander	FC-PWRPAD	3/ctn.

## TRIM-TEX SANDING HEADS AND ACCESSORIES

### 540 Pro Series Sander Head & Accessories

Non-flip design head with a 60% larger sanding surface. Patented hook and loop design allows for the all-in-one sanding pads to be changed quickly. Sanding pads come in 16 pieces per box (4 packs of 4 sanding pads).



<b>TT0540P</b>	540 Pro Series Sander with Pole	<b>New</b>
<b>TT0540</b>	540 Pro Series Sander (Head only)	
<b>TT0550-080</b>	Sanding Pads (# 80 Grit)	16 pads/ctn.
<b>TT0550-100</b>	Sanding Pads (#100 Grit)	16 pads/ctn.
<b>TT0550-120</b>	Sanding Pads (#120 Grit)	16 pads/ctn.
<b>TT0550-150</b>	Sanding Pads (#150 Grit)	16 pads/ctn.
<b>TT0550-180</b>	Sanding Pads (#180 Grit)	16 pads/ctn.
<b>TT0550-220</b>	Sanding Pads (#220 Grit)	16 pads/ctn.

\*Pricing found in Trim-Tex Price List\*

SPP01



### Pole Sponger and Accessories

Reversible 4" x 9" x 3/4" thick sanding sponge lasts 25% longer than sandpaper. One sponge will do a 26,000 sq. ft. area. *Can be used for wet or dry sanding.* Pole sponger refills available in Medium grit (#80) or Fine grit (#120).

<b>SPP00</b>	Pole Sponger Head (Female End)	6/ctn.
<b>SPP01</b>	Pole Sponger Head (Male End)	6/ctn.
<b>SPP02</b>	Pole Sponger Refill (Medium Grit)	6/ctn.
<b>SPP03</b>	Pole Sponger Refill (Fine Grit)	6/ctn.
<b>SPP04</b>	4' Metal Pole (only)	<b>New</b> 1/ctn.

### Circle Brand Express Sander

Heavy duty clips allow for quick sandpaper change. Large sanding head eliminates flipping and increases productivity.

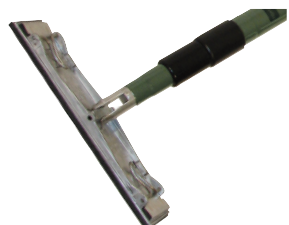

<b>CB011</b>	Express Sander (Handle Only)	1/ctn.
<b>CB012</b>	Express Sander with 4' Fixed Handle	1/ctn.
<b>CB013</b>	Express Sander (Head Only)	1/ctn.
<b>CB014</b>	Express Sander with 3'-7.5' Extension Pole	<b>New</b> 1/ctn.

### Circle Brand Pole Sanders

Professional sander for finishing off ceiling and wall joints. Fully pivoted head. Screw down clamps and rubber pads for securing sandpaper to sander head.



<b>CB15021</b>	Plastic Pole Sander Head only, (Female Thread End)	10/ctn.
<b>CB15025</b>	Aluminum Pole Sander Head only, (Male Thread End)	6/ctn.
<b>CB15024</b>	Aluminum Pole Sander with 4' Wooden Pole	<b>New</b> 1/ctn.

### Sanding Poles **New**

A wide variety of extension poles and wooden poles for use with the 540 Sander, Full Circle Sanders, etc.



<b>TT0376</b>	48" Aluminum Sanding Pole	10/ctn.
<b>TT0374</b>	72" Aluminum Sanding Pole	10/ctn.
<b>TT0375</b>	Adjustable Pole 4'- 6.5'	10/ctn.
<b>TT0376</b>	Heavy Duty Adjustable Fiberglass Pole 3'- 6'	6/ctn.
<b>TT0380</b>	Pole Adapter	10/ctn.

### Circle Brand Aluminum Extension Pole

Aluminum Sander Pole is fully extendable from 4' to 8'.



<b>CB15059</b>	Aluminum Extension Pole with Male Threaded End	1/ctn.
<b>CB15060</b>	Aluminum Extension Pole for Express Sander & EZ Glide Wipers	1/ctn.

### Circle Brand 4' Sander Poles

Wooden Sander Poles comes with both male and female threaded ends.



<b>CB15026</b>	Wooden Sander Pole (Female End)	1/ctn.
<b>CB15026M</b>	Wooden Sander Pole (Male End)	1/ctn.

### Circle Brand Metal Adapter

Aluminum pole adapter that attaches a standard sander head to most painters poles.



<b>CB15027</b>	Metal Adapter	50/ctn.
----------------	---------------	---------



**Circle Brand Fiberglass Mesh Tape**

Apply self-adhesive mesh tape directly to drywall joint and cover tape with a setting type drywall compound. Finish joint using regular drywall compound as per manufacturer's instructions.



<b>T3000</b>	2" x 500' Mesh Tape "ULTRATHIN"	12/ctn.
<b>T3001</b>	2" x 500' Mesh Tape	12/ctn.
<b>T3002</b>	2" x 300' Mesh Tape	12/ctn.
<b>T3003</b>	12" x 150' Mesh Tape	9/ctn.
<b>T3004</b>	4" x 150' Mesh Tape	27/ctn.
<b>T3005</b>	6" x 150' Mesh Tape	18/ctn.
<b>T3006</b>	34" x 150' Detail Mesh	9/ctn.
<b>T3007</b>	2 1/2" x 500' Mesh Tape	10/ctn.
<b>T3008</b>	2" x 150' Detail Mesh	27/ctn.
<b>T3009</b>	2" x 65' Detail Mesh	24/ctn.



**Circle Brand 2 in 1 Mesh Taper**

Designed for ease of use in both corners and flats. Unique beveled roller locks into position for applying tape to corner joints. Beveled roller locks into retractable position for easy set-up when applying tape to flat joints. Taper is designed to accommodate 300' x 2" mesh tape roll.

<b>ST0011</b>	Mesh Taper	1/ctn.
---------------	------------	--------



**EZ "FIRE" Tape *New***

Save up to 60% of installation time over conventional taping methods. Works with both wood and steel beam construction. Permanent adhesion to drywall. Easy mudless application. Rated for use in Fire Wall construction in Canada by Intertek Testing Service. One and two hour rated firewall construction.

<b>EZTAPE</b>	EZ "FIRE" Tape	12/ctn.
---------------	----------------	---------



**Sure Corner Roll-on Bead**

Two metal strips on paper designed for easy finishing of drywall corners and off angles. Apply with drywall compound.

<b>T3010</b>	2"x 100' Roll-On Bead	10/ctn.
--------------	-----------------------	---------



**Yellow "CAUTION" Tape**

3" x 1000' Roll Barricade Tape.

<b>S6000</b>	Yellow "CAUTION" Tape	6/ctn.
--------------	-----------------------	--------



**Red "DANGER" Tape**

3" x 1000' Roll Barricade Tape.

<b>S6005</b>	Red "DANGER" Tape	6/ctn.
--------------	-------------------	--------



**Circle Brand Chalk Line Reel (100')**

Heavy duty chalk line reel is ideal for marking long straight lines on relatively flat surfaces. Die-cast aluminum casing.

<b>CB15031</b>	100' Heavy Duty Chalk Reel	12/ctn.
----------------	----------------------------	---------



**Keson 8oz. Chalk Line Refill**

Increases efficiency and decreases the mess associated with filling chalk lines and boxes. Formulated to provide a perfect strong, sharp line every time.

<b>ST0200</b>	Red Chalk Powder	48/ctn.
<b>ST0201</b>	Blue Chalk Powder	48/ctn.
<b>ST0202</b>	Black Chalk Powder <i>New</i>	48/ctn.



**Circle Brand Concentrated Chalk Dye**

Water-resistant lines hold your mark. Great flow for easy chalk lines and box fill-ups. Comes in a 3 lb. container. Lasts longer than you standard chalk powders.

<b>ST0204</b>	Circle Brand Blue Chalk Dye	4/ctn.
<b>ST0205</b>	Circle Brand Red Chalk Dye	4/ctn.





### Compound Tubes

Significantly reduces mudding and taping application times. To be used with EZ Glide Wipers and Applicators as well as Flat and Corner Applicators. Available in 18", 36" and 42" sizes.

<b>CB002</b>	18" Compound Tube	1/ctn.
<b>CB003</b>	36" Compound Tube	1/ctn.
<b>CB004</b>	42" Compound Tube	1/ctn.
<b>CB005A</b>	Replacement Ball End	
<b>CB005B</b>	Replacement Cone End	
<b>CB005C</b>	Replacement Piston Kit	

### Circle Brand EZ Glide Wipers and Applicators

Circle Brand wipers and applicators with wheels gives you an "EZ Glide" from corner to corner. Use the EZ Glide Applicator with an 18", 36" or 48" compound tube. Feather and smooth compound with less effort, less fatigue and less money!



<b>CB020</b>	2" EZ Glide Wiper	6/ctn.
<b>CB020-CR</b>	2" EZ Glide Wiper with Tape Creaser <i>New</i>	6/ctn.
<b>CB021</b>	3" EZ Glide Wiper	6/ctn.
<b>CB021-CR</b>	3" EZ Glide Wiper with Tape Creaser <i>New</i>	6/ctn.
<b>CB022</b>	3.5" EZ Glide Wiper	6/ctn.
<b>CB023</b>	4" Corner Flusher	6/ctn.
<b>CB025</b>	2" EZ Glide Applicator	6/ctn.
<b>CB026</b>	3" EZ Glide Applicator	6/ctn.
<b>CB027</b>	3.5" EZ Glide Applicator	6/ctn.
<b>CB028</b>	4" Direct Corner Flusher	6/ctn.
<b>CB060</b>	Retainer Spring Replacement	
<b>CB062</b>	Wheel & Axletree Replacement	
<b>CB063</b>	Stainless Steel Skid Plate with screws and washers	

### Circle Brand Flat and Corner Applicators

Used with compound tubes to apply joint compound to taped joints, angles and corners. Joint compound is applied evenly and smoothly.



<b>CB040</b>	90° Inside Corner Applicator	1/ctn.
<b>CB040A</b>	Wheel Assembly Kit for <b>CB040</b>	
<b>CB040B</b>	Stainless Steel Skid Plate Kit (2) for <b>CB040</b>	
<b>CB040C</b>	Retainer Spring for <b>CB040</b>	
<b>CB041</b>	90° Outside Corner Applicator	1/ctn.
<b>CB042</b>	Flat Applicator	1/ctn.
<b>CB042A</b>	Retainer Spring for <b>CB042</b>	

### Circle Brand Wiper/Applicator Handle

Handles for our EZ Glide wipers and applicators.



<b>CB006</b>	Wiper/Applicator Handle with Ball End	1/ctn.
<b>CB009</b>	Wiper/Applicator Extension Handle (3' to 7.5') with Ball End <i>New</i>	1/ctn.
<b>CB007</b>	Replacement Ball End Only	
<b>CB008</b>	Replacement Rubber Grip	

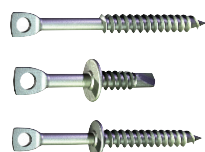

### EyeLags for Steel and Wood *New*

For attaching suspended ceiling hanger wire to steel decking or wood joists. Goes in with ease using the EyeLag Installation Tool (GBELAT).

<b>GB3ELZ</b>	3" EyeLag Screws (for Wood Joist)	1000/ctn.
<b>GBH2</b>	2" Self Drilling EyeLags (for Steel)	2000/ctn.
<b>GBH4</b>	2 3/4" Self Drilling EyeLags (for Steel)	1000/ctn.
<b>GBH3</b>	2 3/4" Self Tapping EyeLags (for Steel)	1000/ctn.



### Eye Lag Installation Tool

Chucks into 3/8" drill. Used to install various eye lag screws.

<b>GBELAT</b>	Eye Lag Installation Tool	1/ctn.
---------------	---------------------------	--------



### 3" Magnetic Bit Tip Holder

Used to magnetize drywall bits to decrease screw droppage from drill and bit tips.

<b>GBMBH143</b>	3" Magnetic Bit Tip Holder	1/ctn.
-----------------	----------------------------	--------



### #2 Phillips Bit Tips

Designed to work & last longer than other standard bit tips.

<b>GB2BIT</b>	#2 Phillips Bit Tips	100/bag
---------------	----------------------	---------

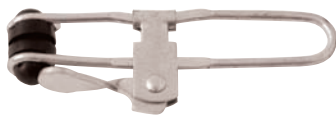

**Rubber Tipped Line Clamps**

The preferred clamp for installing T-Bar ceilings. Clamp holds grid together for pop-ripping or aligning during installation. Rubber cushions will not scratch grid surfaces.

**CB15032** 4" Line Clamp 100/ctn.



**Jet Line**

Tough, strong high tension strength nylon line is ideal for aligning and levelling T-Bar grid for a suspended ceiling. Bright orange colour makes it more visible than standard white string line.

**CB15033** Jet Line 450' 25/ctn.



**The Serpent Wrench *New***

Secure suspended ceiling grids to manufacturers specifications and to Provincial Building codes. Rapidly twists #9 or #12 hanger rods to fasten suspended ceilings. Ten times faster than using pliers or by hand. Sold as individual units.

**ST0015** The Serpent Wrench 12/display

*Purchase 12 Serpent Wrenches and receive a free Serpent Wrench Countertop Display unit.*

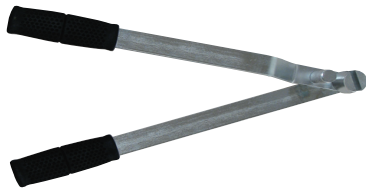

**Circle Brand Wire Bender**

Designed to easily bend and shape heavy-gauge hanger/pencil rods to fit into hard-to-reach places. Decreases installation time significantly.

**ST0013** Wire Bender 1/ctn.

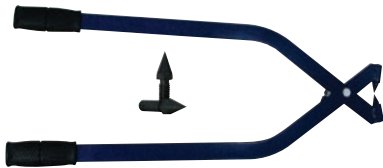

**Circle Brand Deck Punch**

Used to punch holes in Q-decking to allow for installation of suspended ceilings. Replacement teeth available.

**ST0012** Deck Punch 10/ctn.  
**ST0012A** Replacement Deck Punch Teeth



**Circle Brand End Cutting Nippers**

8" heavy-duty cutting tool designed to cut hanger/pencil rod used for suspended ceilings. Hardened angled cutting edges cut material clean and remain sharp.

**ST0014** End Cutting Nippers 6/ctn.

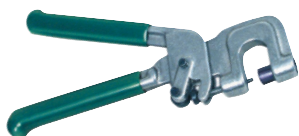

**Kraft Grid Hole Punch *New***

Specifically designed for acoustical grid systems. "Punches" or cuts perfect 1/8" holes for various applications.

**KFGG159** Grid Hole Punch 5/ctn.



**Circle Brand Mini Stud Crimper**

Ideal tool for joining metal studs to metal track. Nickel plated to prevent corrosion.

**ST0001** Mini Stud Crimper 6/ctn.

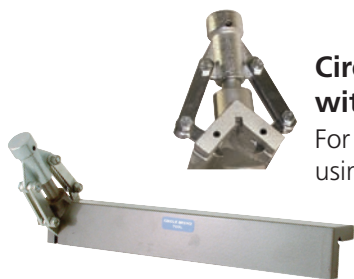

**Circle Brand Cornerbead Clincher Tool with Rubber Mallet**

For fastening metal cornerbead to drywall without using nails or screws.



- ST0002** 1¼" Clincher 12/ctn.
- ST0003** 1⅛" Clincher 12/ctn.
- ST0004** Clincher Repair Kit
- ST0005** Replacement Striker Head



**Circle Brand Rubber Mallet**

Hard rubber head with sturdy hardwood handle.

- CB17523** 16 oz. Rubber Mallet 6/ctn.
- CB17524** 24 oz. Rubber Mallet 6/ctn.
- CB17525** 32 oz. Rubber Mallet 6/ctn.

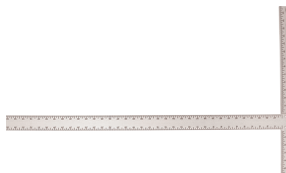

**Circle Brand T-Squares**

Clear anodized aluminum finish. Heavy-duty 3/16" blade. Reverse ruled blades for making precise measurements in either direction. Head is calibrated to make accurate 16" stud measurements.

- CB3999** 48" T-square with 3/16" Blade 6/ctn.
- CB4000** 54" T-square with 3/16" Blade 6/ctn.



**Circle Brand Drywall Rasp**

Used to shave rough drywall cuts. 5½" long. Replacement blades available.

- ST0221** Drywall Rasp 5½" 12/ctn.
- ST0222** Replacement Blade



**Circle Brand Nylon Mason's Line**

No. 18 Braided Nylon Masons' Line used to create straight lines and level surfaces or laying out posts, patios, footings, brick walls and more. Gold colour only.

- ST0210** Gold Line 500' ~24/ctn.



**Circle Brand Circle Cutter**

Cuts up to 16" diameter. Hardened steel cutting blade for longer life. Calibrated steel shaft and blade cuts sharp, clean round holes quickly and easily. Great for potlight installation.

- CB15250** Circle Cutter 12/ctn.



**Circle Brand Drywall Stripper**

Perforated wheels cut both sides of drywall. Ideal for narrow, hard to make cuts. Wood handle features an adjustable thumb screw to cut 4½" or less.

- CB15028** Drywall Stripper 1/ctn.
- CB15028A** Replacement Wheels Kit (2 wheels)



**Goldblatt Blade Runner**

Cuts curves, straights and corners in one easy application. Cutting time is reduced in half compared to a standard utility knife. Long lasting blades cut over 3700 feet. Also ideal for straight cuts with most boards. Cuts ½" and 5/8" and exterior drywall.

- ST0060** Goldblatt Blade Runner 6/ctn.
- ST0061** 12 Pack Replacement Blades



CB4001

**Circle Brand Drywall Foot Lifters**

Enables one person to lift board up to 3" high on wall. Heavy duty construction.

- CB4001** Mini-Lifter 6/ctn.
- CB4002** Economy Mini Lifter 6/ctn.
- CB4003** Roll Lifter 2/ctn.
- CB4004** Fixed Fulcrum Lifter 6/ctn.
- CB4005** Stirrup Lifter 4/ctn.



CB4002



CB4005



CB4003

CB4004



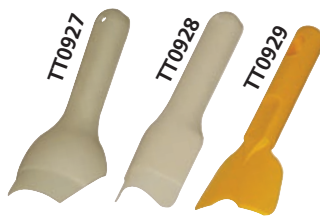

**Trim-Tex Bullnose Cleaning and Finishing Tools**

Cleaning tools are designed to clean compound from 3/4" outside and splayed Bullnose beads. Finishing tools are designed to finish Bullnose archways. Cleans off excess compound while helping to fill the slots with mud.

- TT0927** 1 1/2" Archway Finishing Tool (Ea.) 5/ctn.
- TT0928** 3/4" Archway Finishing Tool (Ea.) 12/ctn.
- TT0929** 3/4" Cleaning Tool (Ea.) 10/ctn.

*\*Pricing found in Trim-Tex Price List\**

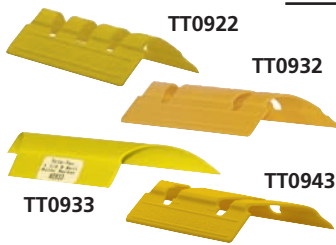

**Trim-Tex Miter Markers**

Tools for various sizes of Bullnose beads, has Miter markings for 90° and 135° off-angle inside corners (1 1/2" Miter marker only does 90° corners).

- TT0922** 350 Bull Miter Markers (Ea.) 40/ctn.
- TT0932** 3/4" Bullnose Miter Marker (Ea.) 40/ctn.
- TT0933** 1 1/2" Bullnose Miter Marker (Ea.) 5/ctn.
- TT0943** Chamfer Miter Marker (Ea.) 40/ctn.

*\*Pricing found in Trim-Tex Price List\**

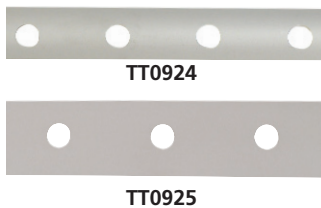

**Trim-Tex Bullnose Splicers**

Used to join 2 pieces of Bullnose beads. Unique spring action allows splicers to be snapped into beads for perfect alignment, especially where archway and 90° Bullnose beads meet. Use #710 caulk to eliminate cracking.

- TT0924** 350 Bull Splicer 40/ctn.
- TT0925** 3/4" Bullnose Splicer 100/ctn.

*\*Pricing found in Trim-Tex Price List\**



**Circle Brand 25' Measuring Tapes**

Experience the stability of our rigid 1" wide tape widths when measuring long distances and/or heights. Double locking mechanism (hold and release or lockup).

- CB38075** Imperial 24/ctn.
- CB38076** Imperial & Metric 24/ctn.



**Circle Brand Carpenter Pencils**

7" carpenter pencils designed for marking on various surfaces.

- ST0215** Carpenter Pencils 72/ctn.



**Midwest Aviation Snips**

Cuts metal up to 18 gauge. The compound lever action makes cutting easy. "Bulldog" snips cuts framing up to 16 gauge.

- ST6716L** Left Cut 6/ctn.
- ST6716S** Straight Cut 6/ctn.
- ST6716R** Right Cut 6/ctn.
- ST6716A** "Long" Straight Cut 6/ctn.
- ST6716B** Bulldog Snips 6/ctn.

**Circle Brand Aviation Snips**

Cuts metal stud and track up to 18 gauge.

- CB4100** Straight Cut 6/ctn.
- CB4101** Left Cut 6/ctn.
- CB4102** Right Cut 6/ctn.



**Wal-board Drywall Saw with Wooden Handle**

Heavy duty 6" utility saw with steel blade and chisel point to penetrate drywall. Special tooth design for long life. Bonded wooden handle.

- WT04001** 6" Utility Saw with Contoured Wooden Handle 6/ctn.



**Circle Brand Drywall Shark Saw with New Wooden Handle**

Heavy duty 6" drywall saw with wood handle grip designed to penetrate and cut drywall smoothly.

- CB38049** 6" Shark Saw with Wooden Handle 6/ctn.



**Circle Brand Drywall Shark Saw with Rubber Handle**

Heavy duty 6" drywall saw with rubber grip handle designed to cut smoothly and stay sharper longer.

- CB38048** 6" Shark Saw with Rubber Grip 6/ctn.



**Rockeater "Shark" Drywall Saw**

**ST0227**

6" Drywall Saw 12/ctn.

High quality carbon steel, tempered for long lasting sharpness. Chisel point blade with ergonomic elastomer handle.



**Circle Brand Drywall Saw**

**CB38040**

15" Drywall Saw 6/ctn.

Solid, high impact plastic handle. Tough, stiff blade with coarse teeth. Tapered nose for easy drywall penetration.



**Wal-board Utility Knife**

**WT15001**

Wal-board Utility Knife 12/ctn.

Fixed blade utility knife with serrated grip. Comes with 3 blades. Designed to prevent blade "pull-out" or "fold-back".



**Circle Brand Utility Knife**

**CB38045**

Circle Brand Utility Knife 12/ctn.

Fixed blade knife. Comes with 3 blades. Heavy-duty metal body with textured slip-resistant grip.



**Circle Brand Quick Change Utility Knife**

**CB38044**

Utility Knife (with Case) 6/ctn.

Heavy duty utility knife has a quick open design, comes with carrying case. Accepts standard utility blades.



**Wal-board Folding Utility Knife *New***

**WT15007**

Wal-board Folding Utility Knife 12/ctn.

Lightweight knife accepts all standard utility blades. Comes with 6 blades inside extra blade storage area in handle and belt clip.



**Circle Brand Utility Knife Blades *New***

**CB38041**

Double Notch Type 12/ctn. 10 blades per pack

**CB38043**

Double Notch Type 12/ctn. 100 blades per pack

Multi-purpose heavy duty replacement blades for most standard utility knives (0.25" thick). Blades come with a convenient plastic dispenser that hangs for easy storage.

**OLFA Knives and Scrapers**

Quality high performance OLFA tools are designed for long life, with durable, premium quality handles to ease

hand and wrist fatigue. Snap-off blades are engineered of the finest quality steel, ensuring exceptional sharpness and edge retention.



WTT CODE	DESCRIPTION	COMPATIBLE BLADES	PART NO.	CARTON QTY.
OF001	90° Cutting Base Utility Knife	LB/LBB	CL	6/ctn.
OF002	Ratchet Lock Utility Knife	LB/LBB	L-1	6/ctn.
OF003	Ratchet Lock Utility Knife with Rubber Inset	LB/LBB	L-2	6/ctn.
OF004	Comfort Grip Rubber Reinforced Utility Knife	LB/LBB	LA-X	6/ctn.
OF005	Five Position Utility Knife	SKB-2	UTC-1	6/ctn.
OF006	Extra Heavy Duty Utility Knife with Rubber Inset	HB/HBB	H-1	6/ctn.
OF007	Extended Length Utility Knife	LB/LBB	XL-2	6/ctn.
OF008	Extra Heavy Duty Utility Knife with Ratchet Lock	HB/HBB	NH-1	6/ctn.
OF009	"SNAPit 'N' TRAPit" Auto Lock Utility Knife	LB/LBB	DL-1	6/ctn.
OF010	Multi-Blade Auto Load Utility Knife	LB/LBB	PL-1	6/ctn.

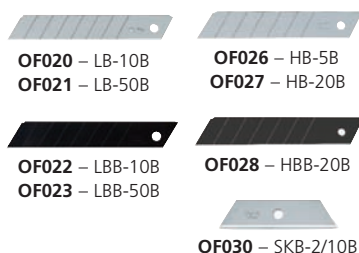

WTT CODE	DESCRIPTION	BLADES PER PK.	COMPATIBLE KNIVES	PART NO.	CARTON QTY.
OF020	Heavy Duty Blades	10	CL/DL-1/L-1/L-2/LA-X/PL-1/XL-2	LB-10B	6/ctn.
OF021	Heavy Duty Blades	50	CL/DL-1/L-1/L-2/LA-X/PL-1/XL-2	LB-50B	6/ctn.
OF022	Ultramax Heavy Duty Blades	10	CL/DL-1/L-1/L-2/LA-X/PL-1/XL-2	LBB-10B	6/ctn.
OF023	Ultramax Heavy Duty Blades	50	CL/DL-1/L-1/L-2/LA-X/PL-1/XL-2	LBB-50B	6/ctn.
OF026	Extra Heavy Duty Blades	5	H-1/NH-1	HB-5B	6/ctn.
OF027	Extra Heavy Duty Blades	20	H-1/NH-1	HB-20B	6/ctn.
OF028	Ultramax Extra Heavy Duty Blades	20	H-1/NH-1	HBB-20B	6/ctn.
OF030	Trapezoid Blades	10	UTC-1	SKB-2/10B	6/ctn.



**Flat Boxes and Handles**

User adjustable blade holder fine tunes the crown for proper compound distribution. Comes in 7", 10" and 12" boxes.

- AT046** 7" Flat Box
- AT049** 10" Flat Box
- AT052** 12" Flat Box



**EasyClean™ Box**

A TapeTech Automatic innovation. The pressure plate removes easily for faster, more efficient cleaning. Large joint compound capacity and easy clean feature. Comes in 7", 10" and 12" boxes.

- AT047** 7" EasyClean™ Box
- AT050** 10" EasyClean™ Box
- AT053** 12" EasyClean™ Box



**Power Assist™ Box**

A TapeTech Automatic innovation. Spring-assisted pressure plate reduces effort required to apply joint compound. Large joint compound capacity and easy clean feature. Comes in 7", 10" and 12" boxes.

- AT048** 7" Power Assist™ Box
- AT051** 10" Power Assist™ Box
- AT054** 12" Power Assist™ Box



**Box Xtender™ Handle**

Integrated brake provides precise control of box. Xtender™ Handle gives multiple lengths in one telescopic unit. One handle will fit all PowerAssist™, Easyclean & Flat boxes. Position can be extended to reach 3.5m without scaffold.

- AT069** Box Xtender™ Handle

**Finishing Box Handles**

Designed to be used with TapeTech Flat Box, EasyClean™ Box or PowerAssist™ Box. Commonly used on all drywall joints.

- Flat Box Handles**
- AT064** 34" Flat Box Handle
  - AT065** 42" Flat Box Handle
  - AT066** 54" Flat Box Handle
  - AT067** 72" Flat Box Handle

**EasyFinish™ Box Handles *New***

Designed to be used with TapeTech Flat Box, EasyClean™ Box or PowerAssist™ Box. EasyFinish™ bent handle increases leverage and is great when finishing overhead joints.

- EasyFinish™ Box Handles**
- AT082** 34" Flat Box Handle
  - AT083** 42" Flat Box Handle
  - AT084** 54" Flat Box Handle
  - AT085** 72" Flat Box Handle



**Beadboxers™ *New***

Beadboxers retrofit kit for flat boxes allows tapers to "hook and go" on corner beads. Once Beadboxers are installed, simply hook the box on the corner bead and the Flat box will self-guide down the bead, allowing you to finish your Standard and Bullnose beads of any angle with your flatbox!

- ST6730** Beadboxers™ 1/kit



AT040

**EasyClean™ Automatic Taper**

Built with stainless steel and gold anodized aluminum for light weight and durability. Reaches 3m height. Smoothest operating automatic taper available. Designed to be easily cleaned and maintained.

- AT040** Automatic Taper



**MudRunner™**

Ball joint allows flexible positioning. Twist-grip flow control. Attaches directly to Corner Finisher and Mud Heads. State-of-the-art applicator. Delivers compound to corner tools with low effort.

- AT042** MudRunner™
- AT072** Extension for MudRunner (Not Shown)



**Versa-Pole Extension Handles *New***

The REK1 kit provides all 3 extendable handles. REK2 kit provides extendable handles for corner rollers and finishers. All handles adjust from 38"-95". Versa-Pole handles also sold separately.

- AT092** REK1 Versa-Pole kit (3 handles)
- AT093** REK2 Versa-Pole kit (2 handles)
- AT075** HFRE Corner Finisher Versa-Pole 1/pkg.
- AT077** HNRE Nail Spotter Versa-Pole 1/pkg.
- AT079** HRRE Corner Roller Versa-Pole 1/pkg.





**AT091**  
Bazooka Pump

### Bazooka Loading Pump *New*

The Loading Pump fills the automatic taping and finishing tools up to 20% faster than standard loading pumps. The filler adapter is included with the pump. The integrated handle makes simple work of carrying the pump. The pump requires no tools or gaskets to change the filler or gooseneck adapters.

**AT070** –  
Gooseneck for  
Bazooka Pump



**AT091** Bazooka Pump with Filler Attachment  
**AT070** Gooseneck for Bazooka Pump



**AT062**  
EasyClean  
Pump

### EasyClean® Pump

Use the TapeTech Easy Clean Pump to fill the automatic taping and finishing tools. Used in conjunction with the 85T Gooseneck adapter to fill Tapers and the 90T Filler adapter to fill finishing boxes and nail spotters.



**AT071**– Filler  
Attachment

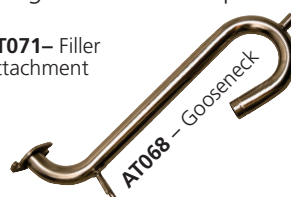

**AT068** – Gooseneck

**AT062** EasyClean™ Pump  
**AT068** Gooseneck for Easyclean Pump  
**AT071** Filler Nozzle for EasyClean Pump



Corner Finisher



EasyRoll Adjustable  
Corner Finisher

### Corner Finishers

Produces crisp and clean interior 90° angles with minimal effort. TapeTech provides 4 versions of this convenient tool. 2" and 3" Standard corner finishers. 3" and 3.5" EasyRoll™ Adjustable corner finishers. Spring-loaded action compensates for imperfect angles.

**AT056** 2" Corner Finisher  
**AT058** 3" EasyRoll™ Corner Finisher  
**AT080** 3.5" EasyRoll™ Corner Finisher *New*  
**AT074** HF Corner Finisher Fiberglass Handle only  
**AT075** HFRE Corner Finisher Extension Handle



**AT044**



**AT044A**

### Mud Head

Applies a wide ribbon of joint compound to external corners. A quick and easy way to prep a corner for a mudset corner bead. Attaches to the MudRunner and Corner Applicator.

**AT044** Mud Head (Outside)  
**AT044A** Mud Head (Inside)



**AT043**



**AT090**

### Corner Rollers

Available in both inside and outside rollers. Embeds the joint tape or bead for inside and outside corners. Designed to apply even pressure, squeezing out excess joint compound.

**AT043** Inside Corner Roller with 4' Fiberglass Handle  
**AT043A** Inside Corner Roller (Tool only)  
**AT090** Outside Corner Roller with 4' Fiberglass Handle  
**AT090A** Outside Corner Roller (Tool only)  
**AT078** HR Corner Roller Fiberglass Handle only  
**AT079** HRRE Corner Roller Extension Handle



### EasyClean™ Nail Spotter

Fills an entire row of dimples in one pass. Two tool sizes to work on any job—2" & 3". Rugged stainless steel construction. Uses skids instead of wheels to extend blade life.

**AT060** 2" Nail Spotter w/ 4' Fiberglass Handle  
**AT060A** 2" Nail Spotter (Tool only)  
**AT061** 3" Nail Spotter w/ 4' Fiberglass Handle  
**AT061A** 3" Nail Spotter (Tool only)  
**AT076** HN Nail Spotter Fiberglass Handle only  
**AT077** HNRE Nail Spotter Extension Handle



### Corner Box Applicator

Used with corner finishers and mud heads to apply compound to 90° corner joints. Lightweight and strong, comes with fixed handle.

**AT059** 7" Corner Applicator w/ 4' Fiberglass Handle  
**AT059A** 7" Corner Applicator (Tool only)  
**AT055** 8" Corner Applicator w/ 4' Fiberglass Handle  
**AT055A** 8" Corner Applicator (Tool only)  
**AT081** Adjustable Corner Applicator Ext. Handle only  
**AT073** HA Corner Applicator Fiberglass Handle only



### BAZOOKA Continuous Flow System *New*

The BAZOOKA Continuous Flow System is revolutionizing the way high production companies finish drywall. Designed to maximize the amount of time the tools are "on the wall". The BAZOOKA Continuous Flow System will help you win more jobs and increase profits. Featuring state-of-the-art ergonomic design, the Continuous Flow System enhances safety by reducing worker fatigue.



**Circle Brand Shingling Hatchets**  
 Square serrated driving head. Blade is notched for nail removal and has an adjustable depth indicator. Rubber grip or solid wood handle.

- CB17534** 14 oz. Solid Hickory 6/ctn.  
Handled Shingling Hatchet
- CB17535** 14 oz. Rubber Grip, Steel 6/ctn.  
Shank Shingling Hatchet



**Circle Brand Drywall Hammers**  
 Serrated driving head, and blade is notched for nail removal. Available with Rubber Grip or Solid Hickory Handles.

- CB17531** 14 oz. Rubber Grip 6/ctn.  
Drywall Hammer. Flat top for nailing in corners
- CB17532** 14 oz. Hickory Handled 6/ctn.  
Drywall Hammer
- CB17533** 14 oz. Rubber Grip 6/ctn.  
Drywall Hammer



**Vaughan Drywall Hatchets**  
 Fully polished heads with milled, crown faces to prevent glancing blows and flying nails. Extra-thin blades. Top quality hickory and/or steel handles.

- ST0074** RWB Hatchet 14 oz. 2/ctn.
- ST0075** BX2 Hatchet 16 oz. 4/ctn.
- ST0076** UDH Hatchet 14 oz. 2/ctn.
- ST0077** WB Hatchet 12 oz. 2/ctn.
- ST0078** WBS Hatchet 12 oz. 2/ctn.



- Hammer Handles**
- ST0080** 15 1/2" Wood Replacement 6/ctn.  
Handle with Wedge
  - ST0081** 13 1/2" Wood Replacement 6/ctn.  
Handle with Wedge



**Magnetic Nail Punch**  
 Stainless Steel punch with magnetic end made for driving nails in hard to reach places.

- ST0006** 5 1/2" Punch Ea.
- ST0007** 8" Punch Ea.

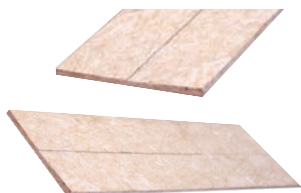

**Trim-Tex BUTTBOARD™ Drywall Backer**  
 Use for perfectly flat ceilings and walls by installing at all butt joints. Pulls back the edges of the cut end of drywall to create a tapered edge.

- TT0825** 48" BUTTBOARD 12 pcs./box
- TT0826** 54" BUTTBOARD 12 pcs./box

*\*Pricing found in Trim-Tex Price List\**



**Trim-Tex BACKERBOARD™**  
 High strength plywood backing product that allows you to attach cabinets, shelves, grab rails, etc. Installs inside the wall cavity, not over the studs, resulting in a perfectly flat wall.

- TT0830** 16" FireTreated 20 pcs./box
- TT0831** 16" Standard 20 pcs./box
- TT0832** 24" FireTreated 20 pcs./box
- TT0833** 24" Standard 20 pcs./box

*\*Pricing found in Trim-Tex Price List\**



**Trim-Tex DRYWALL SHIM on a Roll**  
 Straightens uneven framing before hanging drywall. Flat walls simplify cabinet installation. Pre-scored every 18" to "snap-off" to desired length.

- TT0970** 1/16" Shim (150') Ea. 6 rolls/case
- TT0971** 1/8" Shim (85') Ea. 6 rolls/case

*\*Pricing found in Trim-Tex Price List\**







**LEATHER POUCHES AND ACCESSORIES** *New*



**Drywall Tool Pouch**

Top grain oil tanned leather with rust resistant hammer, tape and snip holder.

**CBL002**  
**CBL003**

Drywall Tool Pouch – Left Hand  
Drywall Tool Pouch – Right Hand



**Drywall Nail Bag**

Drywall nail bag with adjustable nylon belt. Three separate pockets for carrying various fasteners. Top grain oil tanned leather.

**CBL020**

Drywall Nail Bag



**Nail / Tool Bag**

Multi-use drywall nail and tool pouches with convenient metal or leather side loop for hammer or hatchet. Top grain oil tanned leather.

**CBL021**

Nail/Tool Bag with  
10 Pocket Leather Loop

**CBL022**

Nail/Tool Bag with  
10 Pocket Metal Loop



**Drywall Nail Pouch**

Made from top grain oil tanned leather. Fully bonded for longer wear. Pockets are riveted for additional strength.

**CBL023**

3 Pocket Nail Pouch

**CBL024**

4 Pocket Nail Pouch

**CBL025**

5 Pocket Nail Pouch



**Carpenters Tool Pouch & Apron**

The all in one portable work pouch provides you with a variety of holders and pockets for different hand tools, fasteners, etc., to make your job easier.

**CBL026**

Carpenters Tool Pouch and  
Apron



**Utility Drill Holster with Slot**

Made from top grain oil tanned leather, will hold most screw guns or drills.

**CBL004** Drill Holster w/ Slot, Left Hand

**CBL005** Drill Holster w/ Slot, Right Hand



**Leather Hammer Holder**

This holder conveniently attaches to your regular belt or to a work pouch.

**CBL027** Leather Hammer Holder



**Back Support Work Belt**

3½" back support reduces lower back strain and lined with suede for comfort.

**CBL007**

Large

**CBL008**

Medium

**CBL009**

Small



**Leather Work Belt 2"x 48"**

General purpose work belt for nail bags and tool pouches.

**CBL010**

48" Leather Belt, 2" Wide

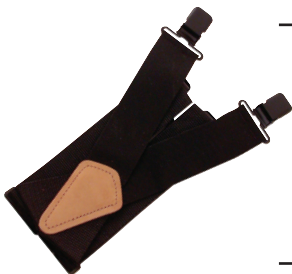

**Nylon Suspenders**

Designed for use with tool pouches, nail bags and construction aprons.

**CBL011**

Nylon Single Suspenders – Black

**CBL012**

Nylon Double Suspenders –  
Black



**Knee Pad Set**

Designed to provide comfort and protection for your knees during flooring or tiling installation projects.

**CBL013**

Top Grain Leather



## NYLON POUCHES AND ACCESSORIES *New*



### Nylon Drywall Tool Pouch

Heavy duty, quality Nylon with rust resistant hammer, tape and snip holder.

**CBN002**

Drywall Tool Pouch – Left Hand

**CBN003**

Drywall Tool Pouch – Right Hand



### Nylon Drywall Nail Bag

Nylon drywall nail bag with adjustable belt. Three separate pockets for carrying various fasteners.

**CBN020**

Drywall Nail Bag



### Nylon Nail / Tool Bag

Rugged construction. Multi-use Nylon drywall nail and tool pouch with convenient metal side loops for hammer or hatchet.

**CBN022**

Nail/Tool Bag with 10 Pocket Metal Loops



### Nylon Drywall Nail Pouch

Made from heavy duty Nylon and are fully bonded for longer wear. Pockets are riveted for additional strength.

**CBN023**

3 Pocket Nail Pouch

**CBN024**

4 Pocket Nail Pouch

**CBN025**

5 Pocket Nail Pouch



### Carpenters Tool Pouch & Apron

The all in one Nylon work pouch provides you with a variety of holders and pockets for different hand tools, fasteners, etc., to make your job easier.

**CBN026**

Carpenters Tool Pouch and Apron



### Nylon Hammer Holder

This Multi-use hammer holder conveniently attaches to your regular belt or to a work pouch. Can be used to carry a variety of various hand tools.

**CBN027**

Hammer Holder



### Nylon Work Belts

General purpose work belt for nail bags and tool pouches.

**CBN010**

48" Work Belt, (2" Wide)

**CBN007**

48" Work Belt, (4" Wide)

**CBN008**

44" Work Belt, (4" Wide)



### Nylon Bucket Tool Caddy

- Extra large 32 pocket bucket tool organizer
- Constructed using heavy duty, water resistant nylon
- Includes built-in drill holster with additional drill bit pockets
- Conveniently fits around a 5 gallon bucket

**CBN028**

Bucket Tool Caddy

**Staple Guns** – Used for many different applications, including Trim-Tex bead installation, vapor barrier, house wrap, installing insulation, etc. Available in both

hammer tacker and lever action styles for standard and Duo-Fast staples.

Parts & schematics for all staple guns are available.



**Internail Hammer Tacker (R19 Type)**  
Tacker that can be used for a variety of material installations. Lite-weight tool decreases arm fatigue. Uses the R19 style staples.

**ST0549** Internail Hammer Tacker (R19) 10/ctn.

**Internail DF50 Hammer Tacker (Duo-Fast)**  
Heavy-duty tacker uses Duo-Fast style staples.

**ST0551** Internail DF50 Hammer Tacker 10/ctn.

**Internail Hammer Tacker (R11 Type)**  
Easy to use hammer tacker that takes up to a 5/16" standard spotnail staple.

**ST0552** Internail Hammer Tacker (R11) 10/ctn.

**Duo-Fast HT550 Hammer Tacker**  
Heavy-duty tacker uses Duo-Fast style staples.

**ST0550** Duo-Fast HT550 Hammer Tacker 5/ctn.



**Internail Lever Tacker (R34 Type)**  
Professional tacker for both Spotnail and Duo-Fast staples. Recommended for Trim-Tex installation and installing vapor barrier, insulation, house wrap, etc.

**ST0554** Internail Lever Tacker (R34) 6/ctn.



**Duo-Fast CS-5000 Lever Tacker**  
Easy rear loading stapler with compact design allowing access in tight applications. Fully adjustable power control. Designed to install Duo-Fast staples (1/2" Crown) with staple leg range from 5/32" to 9/16".

**TT0866** Duo-Fast CS-5000 Lever Tacker (Ea.) 5/ctn.

*\*Pricing found in Trim-Tex Price List\**



**Duo-Fast SureShot® 5020 Pneumatic Stapler**  
Industrial grade quality. Bottom load, aluminum magazine. Easy loading and durable. Designed to install Duo-Fast staples (1/2" Crown) with staple leg range from 3/16" to 9/16".

**TT0867** Duo-Fast SureShot® 5020 Pneumatic Stapler (Ea.) 1/ctn.

*\*Pricing found in Trim-Tex Price List\**



**Duo-Fast Electric Stapler (EWC-5018A)**  
Dual vents in housing for added strength and longer life. Heavy duty return spring ensures efficient operation. Designed to install Duo-Fast staples (1/2" Crown) with staple leg range from 3/16" to 9/16".

**TT0868** Duo-Fast Electric Stapler (EWC-5018A) (Ea.) 1/ctn.

*\*Pricing found in Trim-Tex Price List\**



**Circle Brand Spotnail Staples**  
*Similar to Arrow T50, A11 and Spotnail brands.* Used for Trim-Tex bead application, vapor barrier installation, etc. Use with Internail R11 Style Tacker and Internail Lever Tacker. 3/8" Crown.

**ST0581** 5/16" Staples 5M/box 20 box/ctn.  
**ST0582** 1/4" Staples 5M/box 20 box/ctn.  
**ST0583** 3/8" Staples 5M/box 20 box/ctn.  
**ST0584** 1/2" Staples 5M/box 20 box/ctn.



**Circle Brand Duo-Fast Type Staples**  
*Similar to Duo-Fast 5000 series staples.* These staples have a wider-crown (1/2") than the standard-style staples. Used for Trim-Tex bead installation, vapor barrier installation, etc. Use with Internail DF50 Tacker, Internail Lever Tacker and Duo-Fast HT550 Tacker. 1/2" Crown.

**ST0585** 1/4" Staples 5M/box 20 box/ctn.  
**ST0586** 3/8" Staples 5M/box 20 box/ctn.  
**ST0587** 1/2" Staples 5M/box 20 box/ctn.  
**ST0588** 5/16" Staples 5M/box 20 box/ctn.  
**ST0589** 9/16" Staples 5M/box 20 box/ctn.



**Circle Brand R19 Type Staples**  
Similar to R19 style staples. 1/4" Fine wire staples used for a variety of material installations, including vapor barrier, house wrap, roofing paper, etc. 3/8" Crown.

**ST0580** 1/4" Staples 5M/box 50 box/ctn.



**Duo-Fast 1/2" Divergent Staples (5016D)**  
Designed to be used with various staplers, including CS-5000, EWC-5018A and SureShot® 5020. Staples splay outwards as they enter drywall to increase holding power.

**TT0861** 1/2" Staples 5M/box 20 box/ctn.



## Dust Masks



### 7130 Dust/Mist Respirator

Ideal for sanding drywall and installing fiberglass insulation. NIOSH approved N95 for respiratory protection against certain toxic dusts and mists.

**57130** Dust/Mist Respirator  
20 masks per box 12 boxes / ctn.



### 7140 Dust/Mist Respirator

Same as 7130 but has exhalation valve for worker comfort in hot humid conditions. NIOSH approved N95.

**57140** Dust/Mist Respirator with valve  
10 masks per box 10 boxes/ctn.

## Safety Glasses

Safety glasses are made of lightweight non-conductive high impact polycarbonate material. Deep curve for better viewing. Absorbs more than 99% of harmful UV light. Works both inside and outside.



**S-T13501-12** 180° Slimline™ Safety Eyewear (Clear) 12 pairs/ctn.



**S-T65005-10** Lightning Safety Eyewear (Clear) 10 pairs/ctn.

**S-T65015TCG-10** Lightning Safety Eyewear (Mirror) 10 pairs/ctn.



**S81005** Rebel™ Safety Eyewear (Clear) 12 pairs/ctn.

*Sold by full carton quantities only*

## DEC-I 4200 Earplugs



These comfortable ear plugs are specifically designed to maximize noise protection. Manufactured using disposable polyurethane foam, these ear plugs expand to fit ear canal. Available in both corded & uncorded.

**S284240CO-1** Ear plugs (Corded) 100 pairs/ctn.

**S284200UO-1** Ear plugs (Uncorded) 200 units/ctn.

## Work Safety Gloves



### Gloves with GripDots

Economical and made from knit polyester and cotton. Dotted coating improves grip and durability.

**SK311-12** Gloves with GripDots 12 pairs / pkg.



### DURO Task Gloves

Rubber coated gloves feature a seamless liner that provides superior comfort and lessens hand fatigue. Coated on fingertips and thumbs to minimize wear on high stress areas.

**SNF14/8M-12** Duro Task Gloves (M) 12 pairs / pkg.

**SNF14/9L-12** Duro Task Gloves (L) 12 pairs / pkg.

**SNF14/10XL-12** Duro Task Gloves (XL) 12 pairs / pkg.



### Flex Red Viper Gloves

Foamed PVC palm coated gloves well suited to handle both wet and dry objects. Prevents slippage when moving or positioning material.

**SNF11/9L-12** Flex Red Viper Gloves (L) 12 pairs / pkg.

**SNF11/10XL-12** Flex Red Viper Gloves (XL) 12 pairs / pkg.



### Cut Resistant Gloves

The advanced seamless shell contains Kevlar® for cut resistance and Lycra® for comfort and fit. Increased protection for hardworking hands.

**SNFK13/9L-12** Cut Resistant Gloves (L) 12 pairs / pkg.

**SNFKL13/10XL-12** Cut Resistant Gloves (XL) 12 pairs / pkg.



**Aluminum Benches top step 7" wide**

- 300 lb. load limit. Meets or exceeds OSHA and CSA Standards.

Type 1A Extra-Heavy Duty bench. Aluminum extrusion with non-slip foot pads  
Heavy-duty spreaders for extra durability.



ST0719LH1/ST0719LHF



ST0719LS

<b>ST0700</b>	2' High x 20" Wide	Ea.
<b>ST0701</b>	2½' High x 20" Wide	Ea.
<b>ST0702</b>	3' High x 20" Wide	Ea.
<b>ST0703</b>	4' High x 20" Wide	Ea.
<b>ST0704</b>	2' High x 14" Wide	Ea.
<b>ST0705</b>	3' High x 14" Wide	Ea.
<b>ST0709</b>	2' High x 30" Wide	Ea.
<b>ST0710</b>	2½' High x 30" Wide	Ea.
<b>ST0711</b>	3' High x 30" Wide	Ea.
<b>ST0712</b>	4' High x 30" Wide	Ea.
<b>ST0713</b>	5' High x 30" Wide	Ea.
<b>ST0714</b>	6' High x 30" Wide	Ea.
<b>ST0714-8</b>	8' High x 30" Wide	Ea.
<b>ST0719LS1</b>	Spreader (pair) 2' and 2½' Bench	
<b>ST0719LS2</b>	Spreader (pair) 3' 4' and 5' Bench	
<b>ST0719LS3</b>	Spreader (pair) 6' and 8' Bench	
<b>ST0719LH1</b>	Hinges (pair) All Regular Benches	
<b>ST0724</b>	Rubber Feet Replacement Kit (2L & 2R)	



**Trojan Flat-Top Walkup Bench**

- 300 lb. load limit. Meets or exceeds OSHA and CSA Standards.

Type 1A Extra Heavy-Duty bench, with bolted hinge and spreader, has 3" wide steps. **Top step is 9½" wide.**

<b>ST0694</b>	2' x 30" Flat-Top Bench	Ea.
<b>ST0695</b>	2½' x 30" Flat-Top Bench	Ea.
<b>ST0696</b>	3' x 30" Flat-Top Bench	Ea.
<b>ST0697</b>	4' x 30" Flat-Top Bench	Ea.
<b>ST0719LHF</b>	Hinges for Flat-Top Benches	
<b>ST0719LS4</b>	Spreader for 2' and 2.5' Flat-Top	
<b>ST0719LS5</b>	Spreader for 3' and 4' Flat-Top	
<b>ST0724</b>	Rubber Feet Replacement Kit (2L & 2R)	

**Extendable Aluminum Plank**

- 250 lb. load limit. Meets or exceeds OSHA & CSA Standards.



Easy sliding motion with heavy-duty spreaders. Can be used with any of our aluminum benches.

<b>ST0715</b>	6' to 9' (12" Wide)	Ea.
<b>ST0716</b>	7' to 11' (12" Wide)	Ea.
<b>ST0717</b>	8' to 13' (12" Wide)	Ea.
<b>ST0718</b>	10' to 16' (12" Wide)	Ea.

**Plywood /Aluminum Plank for Sawhorse**

- Rated for 175 lbs./sq. ft. Meets or exceeds OSHA and CSA Standards.



Frame made of high-grade aluminum with 19" wide plywood decking. To be used with any of the Trojan regular benches and Flat Top benches. Plank can be used with a combination of different sized benches. Comes in 7' and 10' lengths.

<b>ST0690</b>	7'L x 19" W Plank	Ea.
<b>ST0691</b>	10'L x 19" W Plank	Ea.



**Circle Brand Walkup Bench**

- 400 lb. load limit.
- Adjustable from 18" to 30" working height.
- Folds into compact, easy to store format.

<b>ST0699</b>	Adjustable Walk-Up Bench	Ea.
---------------	--------------------------	-----



**Ladder Jacks**

- 250 lb. duty rating per ladder jack.

Jacks can be mounted on either the inside or outside of ladder. Double slot tooth arms add extra strength and stability. Accommodates 18" wide plank. Made of high grade aluminum.

<b>ST0723</b>	Ladder Jacks– Sold in Pairs	
---------------	-----------------------------	--



**Fiberglass Step Ladders**

- *CSA Grade 1 – 250 lb. duty rating.*
  - *Meets or exceeds OSHA and CSA Standards*
- Non-conductive fiberglass rails and durable slip resistant feet. Extra heavy-duty 3" serrated aluminum steps create added stability and user confidence.

<b>ST0743</b>	4' Fiberglass Step Ladder	Each
<b>ST0742-5</b>	5' Fiberglass Step Ladder	Each
<b>ST0742</b>	6' Fiberglass Step Ladder	Each
<b>ST0744</b>	8' Fiberglass Step Ladder	Each



**Fiberglass Step Ladders *New***

- *CSA Grade 1A – 300 lb. duty rating.*
  - *Meets or exceeds OSHA and CSA Standards*
- Non-conductive fiberglass rails and durable slip resistant feet. Extra heavy-duty 3" serrated aluminum steps create added stability and user confidence.

<b>ST0745</b>	4' Fiberglass Step Ladder	Each
<b>ST0745-5</b>	5' Fiberglass Step Ladder	Each
<b>ST0746</b>	6' Fiberglass Step Ladder	Each
<b>ST0747</b>	8' Fiberglass Step Ladder	Each
<b>ST0748</b>	10' Fiberglass Step Ladder	Each



**Aluminum Step Ladders**

- *CSA Grade 1A – 300 lb. duty rating.*
  - *Meets or exceeds OSHA and CSA Standards*
- Extra heavy duty, high strength ladder with deep ribbed side rails and additional bracing. Includes slip resistant safety feet. Easily adaptable for a large variety of projects.

<b>ST0735</b>	6' Double Sided Step Ladder	Each
<b>ST0737</b>	7' Double Sided Step Ladder	Each
<b>ST0736</b>	8' Double Sided Step Ladder	Each
<b>ST0738</b>	10' Double Sided Step Ladder	Each



**Multi-Way Aluminum Ladders**

- *CSA Grade 2 – 225 lb. duty rating.*
  - *Meets or exceeds OSHA and CSA Standards*
- This ladder features exceptional versatility. Can be used as a stepladder, trestle ladder, stairway ladder and a straight ladder. The multi-way ladder features exceptional stability and safety in all of the various positions.

<b>ST0740</b>	7' Multi-Way Ladder	Each
<b>ST0741</b>	8' Multi-Way Ladder	Each

**ALUMINUM BENCH and LADDER DUTY RATINGS**

Where applicable, our benches are certified by the Canadian Standards Association (CSA), and meet or exceed OSHA and CSA standards.

**DUTY RATINGS CHART**

DUTY RATING	RATED USE	CSA CODE	ANSI
<b>300 LB.</b>	<b>EXTRA HEAVY DUTY INDUSTRIAL</b>	<b>N/A</b>	<b>TYPE 1A</b>
250 LB.	HEAVY DUTY INDUSTRIAL	GRADE 1	TYPE I
225 LB.	MEDIUM DUTY COMMERCIAL	GRADE 2	TYPE II
200 LB.	LIGHT DUTY HOUSEHOLD	GRADE 3	TYPE III

**OUR BENCHES ARE TYPE 1A (RATED FOR 300 LBS.)**





**Circle Brand 6' Steel Rolling Tower Scaffold**

• 1000 lb. load limit.

Comes with plywood platform and castors.

Unit weight: 145 lbs (65 kgs)

Dimensions:

74"(187 cm) L x 29"(74 cm) W x 72"(189 cm) H.

**ST0729** 6' Steel Rolling Tower with 5" Castors

**ST0727** 5" Replacement Castors

**ST0729A1** Steel Guardrail Set for 6' Steel Rolling Tower.

**ST0729A2** Large Steel Outriggers with 5" castors. Square stem **4 Outriggers per set**

**ST0729A3** Small Steel Outriggers with 5" castors. Square stem **4 Outriggers per set**

**ST0729A4** Plywood platform 29" wide x 67" long.

*"Always use guardrails and outriggers when stacking units for both ST0728 and ST0729."*

ST0727 - 5" Caster

ST0729A4 - Plywood Platform



**ST0734A1** Platform Clamp



**ST0734A2** Guardrail to Platform Locking Pin



**ST0734A4** Safety Clip



**ST0734A5** Guardrail Door Locking Pin

**ST0729A2** - Large Steel Outriggers with Castors (Set of 4)



**ST0729A3** - Small Steel Outriggers with Castors (Set of 4)



**ST0729A1** - Steel Guardrail Set



**Circle Brand 6' Steel Folding Mobile Scaffold**

• 800 lb. load limit.

Comes with 3 planks and castors.

Unit weight: 132 lbs (60 kgs)

Dimensions: 59"(150 cm) L x 29"(74 cm) W x 74"(189 cm) H.

**ST0730** 6' Steel Folding Scaffold

**ST0730A1** Replacement Plank for 6' Steel Folding Mobile Scaffold, 8.5" wide

**ST0730A2** 5" Replacement Castor with Round Stem

**ST0734A4** Safety Clips for Castors

ST0730A2

ST0734A4



Steel Plank - ST0730A1



### Circle Brand 6' Aluminum Rolling Tower Scaffold

• 1000 lb. load limit.

Comes with aluminum platform and castors.

Unit weight: 85 lbs (39 kgs)

Dimensions:

74" (187 cm) L x 29" (74 cm) W x 72" (189 cm) H.

**ST0728** 6' Aluminum Rolling Tower with 5" Castors

**ST0727** 5" Replacement Castors w/ Square Stem

**ST0728A1** Aluminum Guardrail Set for 6' Aluminum or Steel Rolling Towers.

**ST0728A2** Large Aluminum Outriggers with 5" castors. Square stem 4 Outriggers per set

**ST0728A3** Small Aluminum Outriggers with 5" castors. Square stem 4 Outriggers per set

**ST0728A4** Aluminum platform 29" wide x 67" long.

*"Always use guardrails and outriggers when stacking units for both ST0728 and ST0729."*

ST0727 - 5" Caster

ST0728A4 - Aluminum Platform

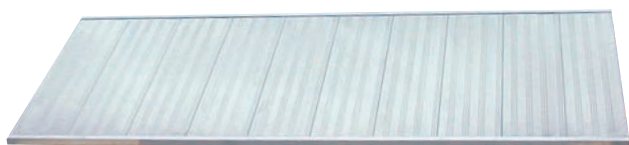

ST0734A1 Platform Clamp



ST0734A2 Guardrail to Platform Locking Pin



ST0734A4 ST0734A6 Safety Clip



ST0734A5 Guardrail Door Locking Pin

ST0728A2 - Large Aluminum Outriggers with Castors (Set of 4)



ST0728A3 - Small Aluminum Outriggers with Castors (Set of 4)



ST0728A1 - Aluminum Guardrail Set



### Circle Brand 6' Aluminum Folding Mobile Scaffold

• 800 lb. load limit.

Comes with 3 planks and castors.

Unit weight: 66 lbs (30 kgs)

Dimensions: 59" (150 cm) L x 29" (74 cm) W x 74" (189 cm) H.

**ST0731** 6' Aluminum Folding Scaffold

**ST0731A1** Replacement Plank for 6' Aluminum Folding Mobile Scaffold, 8.5" wide

**ST0731A2** 5" Replacement Castor with Round Stem

**ST0734A4** Safety Clips for Castors

ST0731A2

ST0734A4

ST0731A1 - Aluminum Plank







**Circle Brand Mini-Mobile Scaffolds (4" and 5" castors)**

• 500 lb. load limit.

Thicker scaffold tubing makes this the most heavy-duty mini-scaffold on the market today. Made for the drywall contractor. Comes with castors, work station and tool tray.

Unit weight: 70 lbs (32 kgs)

Dimensions: 47" (120 cm) L x 22" (56 cm) W x 48" (122 cm) H.

-  **ST0733A1**    **ST0733**    Mini-Mobile Scaffold with 4" Castors    Ea.
-  **ST0733A1-5**    **ST0733-5**    Mini-Mobile Scaffold with 5" Castors *New*    Ea.
- ST0733A1**    4" Replacement Castors    Ea.
- ST0733A1-5**    5" Replacement Castors    Ea.
- ST0733A2**    Replacement Tool Tray    Ea.
- ST0733A3**    Replacement Steel Plank    Ea.

**Scaffold Reference Chart**

	<b>ST0733 Mini-Mobile</b>	<b>ST0728 Aluminum Tower</b>	<b>ST0731 Aluminum Folding</b>	<b>ST0729 Steel Tower</b>	<b>ST0730 Steel Folding</b>
<b>Length</b>	47" (120 cm)	74" (187 cm)	59" (150 cm)	74" (187 cm)	59" (150 cm)
<b>Width</b>	22" (56 cm)	29" (74 cm)	29" (74 cm)	29" (74 cm)	29" (74 cm)
<b>Height</b>	48" (122 cm)	72" (182 cm)	72" (183 cm)	72" (182 cm)	74" (189 cm)
<b>Platform Type</b>	2 Non-slip steel planks (8.5" wide)	28" wide aluminum platform	3 Non-slip alum. planks (8.5" wide)	28" wide plywood/ steel platform	3 Non-slip steel planks (8.5" wide)
<b>Caster Type</b>	4" Push-in	5" – Square Stem	5" – Round Stem	5" – Square Stem	5" – Round Stem
<b>Unit Weight</b>	70 lbs. (32 kgs)	85 lbs. (39 kgs)	66 lbs. (30 kgs)	143 lbs. (65 kgs)	132 lbs. (60 kgs)
<b>Load Capacity</b>	500 lbs. (227 kgs)	1000 lbs. (454 kgs)	800 lbs. (363 kgs)	1000 lbs. (454 kgs)	800 lbs. (363 kgs)
<b>Colour</b>	Yellow	Silver	Silver	Yellow	Yellow
<b>Finish</b>	Powder-Coated	Anodized	Anodized	Powder-Coated	Powder-Coated

*\*All Scaffolds meet or exceed CSA/OSHA Standards and are ANSI compliant\**



**EZ Fold Material Mover *New***

Heavy duty cart is ideal for moving plywood and drywall. Remove handle to easily stack ceiling tiles. Load capacity up to 1800 lbs. Twelve inch base holds up to 23 sheets of 1/2" drywall. Comes with 3 swivel casters and 1 locking swivel caster.



- ST0100**    EZ Fold Material Mover with 3 swivel and 1 locking castor
- ST0100A**    Replacement EZ Fold Material Mover Handle



**Circle Brand Drywall Dollies** – Ideal for handling drywall, plywood, paneling, etc. on the job site or in the warehouse. Dolly ST0101 is designed for loading drywall in confined spaces. Fixed dollies are a one piece welded unit. Modular dollies are

shipped disassembled with hardware included for easy assembly. Most models have a teflon plate over the steel base. *All dollies priced with wheels extra. When ordering, state type of wheels required, from selection shown below.*

**Teflon Base Replacements**

- ST0107** 10" Wide Teflon Base Replacement.
- ST0107-12** 12" Wide Teflon Base Replacement.

- ST0107-14** 14" Wide Teflon Base Replacement.
- ST0107-RS** Replacement Screw Kit for Telfon.
- ST0120** Replacement Nut & Bolt Set for Dolly.



	Type	Teflon Plate	Base Plate Width	Sheets of 1/2" Drywall	Overall Dimensions w/Wheels L x W x H
<b>ST0100</b>	EZ Fold	No	12"	23	46 (117) 25 (64) 46 (117)
<b>ST0101</b>	Fixed	Yes	10"	20	46 (117) 19 (48) 41 (104)
<b>ST0102</b>	Fixed	Yes	12"	24	46 (117) 23 (58) 46 (117)
<b>ST0103</b>	Fixed	Yes	14"	28	46 (117) 24 (61) 47 (119)
<b>ST0104</b>	Modular	Yes	12"	24	47 (119) 23 (58) 44 (112)
<b>ST0105</b>	Modular	Yes	14"	28	47 (119) 25 (64) 44 (112)
<b>ST0106</b>	Fixed	No	16"	32	47 (119) 25 (64) 47 (119)

**Wheel Selection**

- Moulded Rubber – Standard Duty, Economical
- Donut Type – Heavy Duty. More resistant to picking up nails and screws

- ST0110** Moulded Rubber Dolly Wheel, Black Rubber, 8" x 2" Swivel
- ST0111** Moulded Rubber Dolly Wheel, Black Rubber, 8" x 2" Fixed
- ST0108** Donut Type Dolly Wheel, Grey Rubber, 8" x 2" Swivel
- ST0109** Donut Type Dolly Wheel, Grey Rubber, 8" x 2" Fixed
- ST0109A** Donut Type Dolly Wheel, Grey Rubber, 8" x 2" Swivel with Locking Device



**TECHSTAR PLASTICS INC.** Disposal Bins



**Indoor/Outdoor Starcart (10-20)**

Multi-purpose indoor/outdoor cart for use in all weather conditions. Rolls effortlessly through grass, gravel and other uneven surfaces.

- 400 lb. load limit.
- Level volume: 10 cubic feet.

**ST0153**  
Indoor/Outdoor Starcart



**Econo Techtruck (420 EC)**

Disposal bins that will move large, lighter loads. Made of 100% recycled polyethylene.

- 300 lb. load limit.
- Dimensions: 58" L x 28" W x 37" H. Holds 5/8 cubic yard

**ST0150**  
Econo Techtruck



**Regular Duty Techtruck (420 LT)**

Disposal bin that handles large heavy loads easily. Rotationally molded from FDA approved polyethylene.

- 400 lb. load limit.
- Dimensions: 58" L x 28" W x 37" H. Holds 5/8 cubic yard

**ST0151**  
Regular Duty Techtruck



**Regular Duty Techtruck (441 LT)**

Disposal bin that handles large heavy loads easily. Larger bin than the 420 LT.

- 500 lb. load limit.
- Dimensions: 63" L x 35" W x 40" H. Holds 1.1 cubic yards

**ST0154**  
Regular Duty Techtruck



**Heavy Duty Techtruck (420 C)**

Higher placed molded handles makes bin more ergonomic. Double-wall top increases both durability and truck lifespan dramatically.

- 1000 lb. load limit.
- Dimensions: 58" L x 28" W x 37" H. Holds 5/8 cubic yard

**ST0152**  
Heavy Duty Techtruck

**Replacement wheels** – Replacement wheels for Techtrucks and Indoor/Outdoor Starcarts.



**ST0165** – Wheel for Techtruck (4")



**ST0170** – Wheel for Econo Techtruck (10")



**ST0171** – Wheel for Regular and Heavy-Duty Techtruck (10")



**ST0175** – Starcart wheel (20")



# A D J U S T A B L E S T I L T S



Aluminum Single Pole Stilts

### EZ Stride Adjustable Stilts (Load limit 240 lbs.)

- Heavy duty side poles with rubber foot pads.
- Support beams at the side of each leg helps keep balance in check.
- Adjustable heel guard allows you to set proper forward and backward balance.
- Hard rubber soles with specially moulded threads for increased traction provide a firm grip on almost all surfaces.
- With the suspension designed into these stilts, leaning in those awkward high places can be now handled easily.

*Replacement parts are available. (see schematic)*

### EZ Stride Aluminum

<b>CBS005</b>	Single Pole	15" to 23"	1 pair
<b>CBS006</b>	Single Pole	18" to 30"	1 pair
<b>CBS007</b>	Single Pole	24" to 40"	1 pair
<b>CBS008</b>	Single Pole	48" to 64"	1 pair

### EZ Stride Magnesium

<b>CBS010</b>	Single Pole	18" to 30"	1 pair
<b>CBS011</b>	Single Pole	24" to 40"	1 pair



Magnesium Single Pole Stilts



### TRUE STRIDE Stilts 18"-30" *New*

Patented two piece foot plate provides "ankle" function with a heel to toe movement that translates into a smooth natural TRUE STRIDE.

- One foot pad is in full contact with the ground at all times.
- Provides greater stability on uneven surfaces.

*Replacement parts are available. (see schematic)*

<b>CBS016</b>	Single Pole	18" to 30"	1 pair
---------------	-------------	------------	--------

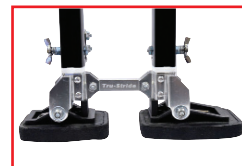

### Comfort Straps for Adjustable Stilts *New*

Manufactured using a very durable and high grade hook and loop fastening system to provide a safe and secure seal around leg and stilt. Built with comfort in mind for the end user.



- Fully adjustable and works with all stilts.
- Provides durability and less leg fatigue.

<b>CBS100</b>	Comfort Straps for Adjustable Stilts	1 pair
---------------	--------------------------------------	--------



# EZ Stride Schematics

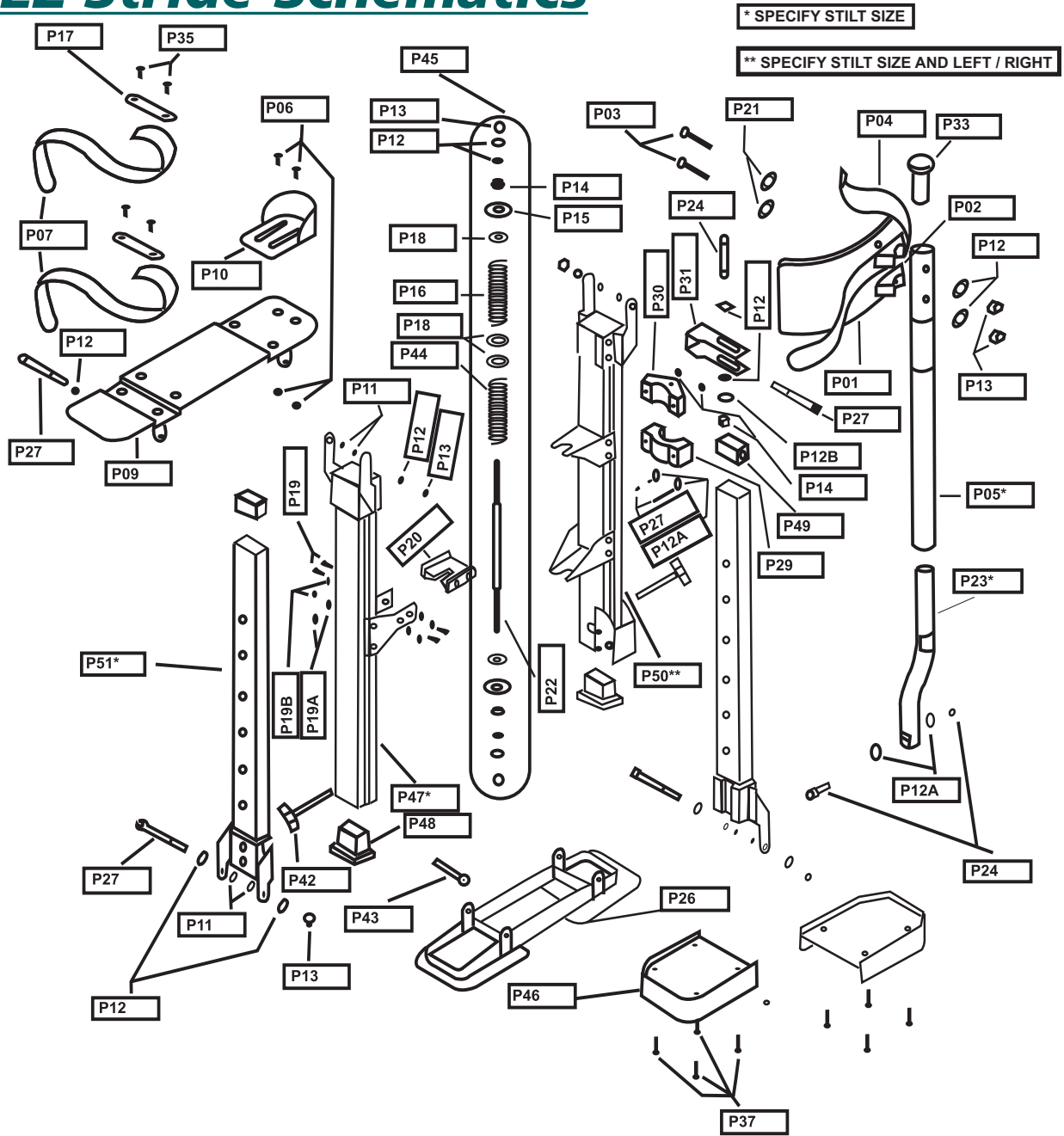

# True Stride Schematics New

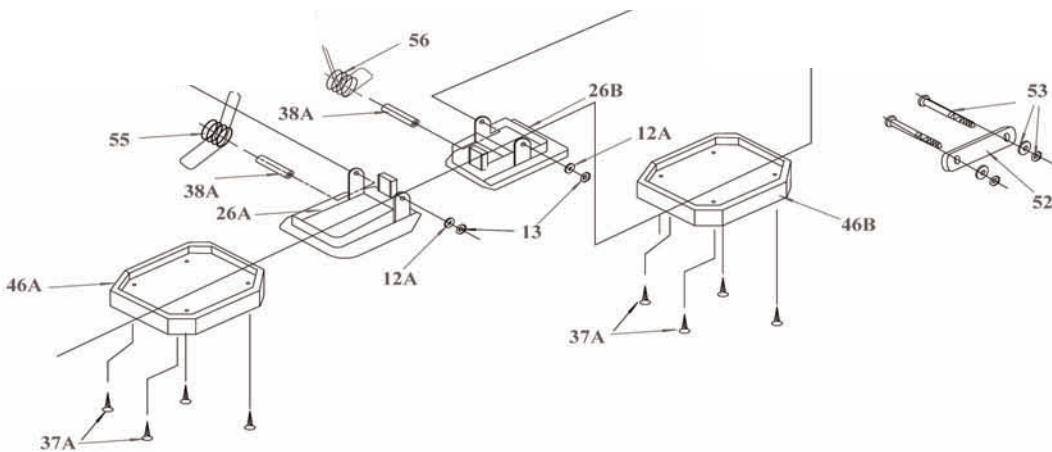

# Stilts Parts List

PART NO.	DESCRIPTION
C BSP01	Leg band with pads and Support Washers
C BSP02	Leg band spacer
C BSP03	1/4"-20 x #2" flat head machine screws w/ locknut
C BSP04	Leg strap
C BSP05-15	1-1/8" O.D. upper strut tube (15"-23")
C BSP05-18	1-1/8" O.D. upper strut tube (18"-30")
C BSP05-24	1-1/8" O.D. upper strut tube (24"-40")
C BSP06	10 – 24 x 1/2" machine screws w/ nuts (heel bracket)
C BSP07	Arch/Toe strap
C BSP09	Nylon foot plate
C BSP10	Heel bracket
C BSP11	Leg bearing
C BSP12	1/4" flat washer – large
C BSP12A	1/4" flat washer – small
C BSP12B	Lock washer
C BSP13	20 – 1/4" locknuts
C BSP14	20 – 1/4" hex nuts
C BSP15	Spring adjuster
C BSP16	Upper coil spring (Brown)
C BSP17	2-3/4" x 3/4" Strap mounting plate
C BSP18	Nylon spring bearing
C BSP19	8 – 3/8" self threading screws
C BSP19A	8 Flat washers
C BSP19B	8 Lock washers
C BSP20	Spring divider
C BSP21	Leg band support washer
C BSP22	1/4" x 7-7/8" stud – threaded at both ends
C BSP23-15	Inter-Lock lower strut tube (15"-23")
C BSP23-18	Inter-Lok lower strut tube (18"-30")
C BSP23-24	Inter-Lok lower strut tube (24"-40")
C BSP24	1/4" x 1-1/2" cap screw with locknut
C BSP26	Floor plate only
C BSP27	20 – 1/4" x 3-1/8" cap screws
C BSP29	Round lock tube clamp (Front)
C BSP30	Round lock tube clamp (Rear)
C BSP31	Metal clamp bracket
C BSP33	Upper strut tube cap plug
C BSP35	Strap mounting screw
C BSP37	Sole mounting screw
C BSP42	Wing bolt with washer
C BSP43	1 – 1/2" plastic spacer
C BSP44	Lower coil spring (Zinc plated)
C BSP45	Spring assembly (1 stilt leg)
C BSP46	Sole pad with 4 screws
C BSP47-15	Forward adjustable leg extrusion (15"-23")

PART NO.	DESCRIPTION
C BSP47-18	Forward adjustable leg extrusion (18"-30")
C BSP47-24	Forward adjustable leg extrusion (24"-40")
C BSP48	Downward large nylon sleeve
C BSP49	Upward small nylon sleeve
C BSP50-15L	Inter-Lok rear outward leg extrusion (L) (15"-23")
C BSP50-18L	Inter-Lok rear outward leg extrusion (L) (18"-30")
C BSP50-24L	Inter-Lok rear outward leg extrusion (L) (24"-40")
C BSP50-15R	Inter-Lok rear outward leg extrusion (R) (15"-23")
C BSP50-18R	Inter-Lok rear outward leg extrusion (R) (18"-30")
C BSP50-24R	Inter-Lok rear outward leg extrusion (R) (24"-40")
C BSP51-15	Inner extension tube (15"-23")
C BSP51-18	Inner extension tube (18"-30")
C BSP51-24	Inner extension tube (24"-40")

## MAGNESIUM STILTS PARTS

C BSPM05-18	Upper strut tube (18"-30")
C BSPM05-24	Upper strut tube (24"-40")
C BSPM47-18	Forward adjustable leg extrusion (18"-30")
C BSPM47-24	Forward adjustable leg extrusion (24"-40")
C BSPM50-18L	Inter-lock rear outward leg extrusion (LT) (18"-30")
C BSPM50-18R	Inter-lock rear outward leg extrusion (RT) (18"-30")
C BSPM50-24L	Inter-lock rear outward leg extrusion (LT) (24"-40")
C BSPM50-24R	Inter-lock rear outward leg extrusion (RT) (24"-40")
C BSPM51-18	Inner extension tube (18"-30")
C BSPM51-24	Inner extension tube (24"-40")

## Parts Unique To TRUE STRIDE Stilts

C BSPTS12A	Washer for Connector Bolt
C BSPTS13	Locknut for Connector Bolt
C BSPTS26A	Front Floor Plate
C BSPTS26B	Rear Floor Plate
C BSPTS37A	Sole Mounting Screws
C BSPTS38A	Connector Bolt
C BSPTS46A	Front Sole Pad (5")
C BSPTS46B	Rear Sole Pad (4.25")
C BSPTS50-18L	Interlock Rear Outward Leg Extrusion (Left)
C BSPTS50-18R	Interlock Rear Outward Leg Extrusion (Right)
C BSPTS51-18	Inner Extension Tube (18"-30")
C BSPTS52	"True Stride" Connector Bar
C BSPTS53	Connector Bar Bolt and Nut Assembly
C BSPTS55	Front Floor Plate Spring (Large)
C BSPTS56	Rear Floor Plate Spring (Small)

## Stilt Parts Kits List

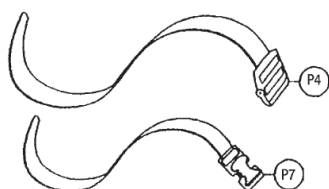

<b>C BSPK-52</b> Replacement Strap Kit
<b>C BSP04</b> Leg strap 2 each
<b>C BSP07</b> Arch/Toe strap 4 each

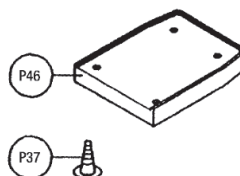

<b>C BSPK-64</b> Replacement Sole Pad Kit
<b>C BSP46</b> Sole pads 4 each
<b>C BSP37</b> Sole mounting screws 16 each

**Professional Drywall Lifter**

**ST0760 – Drywall Panel Lifter Ea.**

- 110 lb. Load Limit.

Professional drywall lifter is designed to lift drywall panels up to 12' long. An 11' lifting height allows for panel placement on most ceilings and walls. Compact and easy to maneuver.

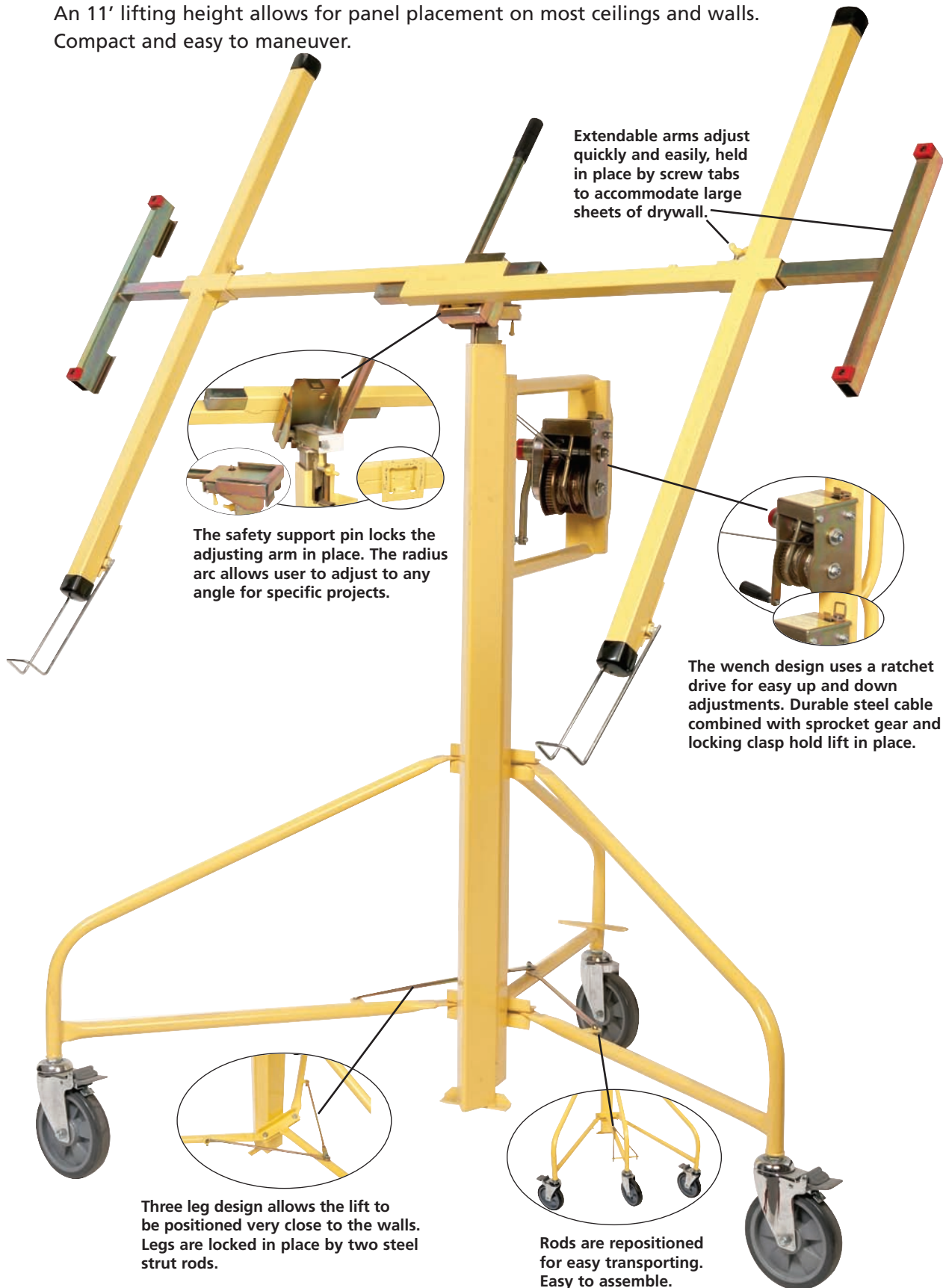

Extendable arms adjust quickly and easily, held in place by screw tabs to accommodate large sheets of drywall.

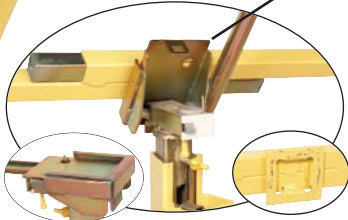

The safety support pin locks the adjusting arm in place. The radius arc allows user to adjust to any angle for specific projects.

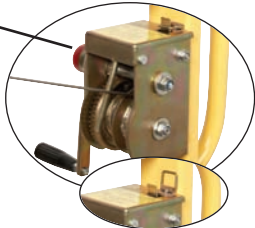

The wench design uses a ratchet drive for easy up and down adjustments. Durable steel cable combined with sprocket gear and locking clasp hold lift in place.

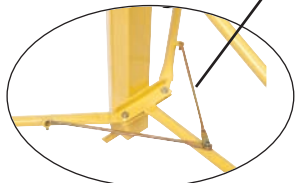

Three leg design allows the lift to be positioned very close to the walls. Legs are locked in place by two steel strut rods.

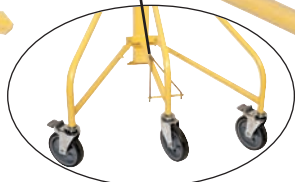

Rods are repositioned for easy transporting. Easy to assemble.



Prod.	Page	UPC Code	Prod.	Page	UPC Code	Prod.	Page	UPC Code	Prod.	Page	UPC Code
AP1414	6	0 08912 00001 9	CB14052	4	6 28903 14021 2	CB17524	17	6 28903 14034 2	CB5010	35	6 28903 14234 6
AP1429	6	0 08912 00002 6	CB14053	4	6 28903 14022 9	CB17525	17	6 28903 14070 0	CB5011	35	6 28903 14235 3
AP69	6	0 08912 00003 3	CB14054	4	6 28903 14023 6	CB17531	22	6 28903 14229 2	CB5016	35	6 28903 14303 9
AP88	6	0 08912 00009 5	CB14061	4	6 28903 14025 0	CB17532	22	6 28903 14183 7	CB5100	35	6 28903 14304 6
AT040	20	8 73876 00147 7	CB14062	4	6 28903 14026 7	CB17533	22	6 28903 14184 4	EZ TAPE	14	6 08419 99251 2
AT042	20	8 73876 00037 1	CB14063	4	6 28903 14027 4	CB17534	22	6 28903 14185 1	FC-FE100	12	1 87691 00038 7
AT043	21	8 73876 00038 8	CB14064	4	6 28903 14028 1	CB17535	22	6 28903 14186 8	FC-FE150	12	1 87691 00039 4
AT043A	21	8 73876 00169 9	CB14071	4	6 28903 14103 5	CB3074	1	6 28903 14011 3	FC-FE220	12	1 87691 00040 0
AT044	21	8 73876 00039 5	CB14072	4	6 28903 14104 2	CB3075	1	6 28903 14012 0	FC-FE-FF-FINE	12	1 87691 00042 4
AT044A	21	8 73876 00040 1	CB14073	4	6 28903 14105 9	CB3076	1	6 28903 14013 7	FC-FE-FF-MED	12	1 87691 00037 0
AT046	20	8 73876 00043 2	CB14074	4	6 28903 14106 6	CB3077	3	6 28903 14060 1	FC-FE-PP	12	1 87691 00041 7
AT047	20	8 73876 00044 9	CB14075	4	0 99922 37706 2	CB3084	1	6 28903 14001 4	FC-FE-RP	12	1 87691 00035 6
AT048	20	8 73876 00045 6	CB14076	4	0 99922 37708 6	CB3085	1	6 28903 14002 1	FC-FLEX	12	1 87691 00034 9
AT049	20	8 73876 00046 3	CB14077	4	0 99922 37710 9	CB3086	1	6 28903 14003 8	FC-FX4	12	1 87691 00046 2
AT050	20	8 73876 00047 0	CB14078	4	0 99922 37712 3	CB3094	1	6 28903 14015 1	FC-PRO-H	12	1 87691 00057 8
AT051	20	8 73876 00048 7	CB14079	4	0 99922 37714 7	CB3095	1	6 28903 14016 8	FC-PWR-PAD	12	1 87691 00032 5
AT052	20	8 73876 00049 4	CB14081	3	0 99922 30718 2	CB3096	1	6 28903 14017 5	FC-R360	12	1 87691 00000 4
AT053	20	8 73876 00050 0	CB14082	3	0 99922 30724 3	CB38040	19	6 28903 14075 5	FC-RP-STD	12	1 87691 00008 0
AT054	20	8 73876 00051 7	CB14083	2	0 99922 35718 7	CB38041	19	6 28903 14295 7	FC-RP-THIN	12	1 87691 00033 2
AT055	21	8 73876 00052 4	CB14084	2	0 99922 35724 3	CB38043	19	6 28903 14275 9	FC-SD80-5	12	1 87691 00025 7
AT055A	21	8 73876 00172 9	CB14085	2	0 99922 35736 1	CB38044	19	6 28903 14296 4	FC-SD100-5	12	1 87691 00026 4
AT056	21	8 73876 00054 8	CB14086	2	0 99922 35712 5	CB38045	19	6 28903 14040 3	FC-SD120-5	12	1 87691 00027 1
AT057	21	8 73876 00055 5	CB15000	4	0 99922 33410 2	CB38048	18	6 28903 14142 4	FC-SD150-5	12	1 87691 00028 8
AT058	21	8 73876 00056 2	CB15001	4	0 99922 33412 6	CB38049	18	6 28903 14297 1	FC-SD180-5	12	1 87691 00029 5
AT059	21	8 73876 00053 1	CB15002	4	0 99922 33414 0	CB38075	18	6 28903 14343 5	FC-SD220-5	12	1 87691 00030 1
AT059A	21	8 73876 00173 6	CB15005	4	6 28903 14035 9	CB38076	18	6 28903 14344 2	FC-SD240-5	12	1 87691 00031 8
AT060	21	8 73876 00058 6	CB15007	4	6 28903 14073 1	CB3999	17	6 28903 14076 2	FC-T180 PLATE	12	1 87691 00053 0
AT060A	21	8 73876 00174 3	CB15008	4	6 28903 14074 8	CB4000	17	6 28903 14059 5	FC-TG100	12	1 87691 00049 3
AT061	21	8 73876 00059 3	CB15010	4	6 28903 14091 5	CB4001	17	6 28903 14054 0	FC-TG150	12	1 87691 00050 9
AT061A	21	8 73876 00175 0	CB15011	4	0 99922 35512 1	CB4002	17	6 28903 14077 9	FC-TG220	12	1 87691 00051 6
AT062	21	8 73876 00060 9	CB15013	3	6 28903 14036 6	CB4003	17	6 28903 14078 6	FC-TRI180	12	1 87691 00048 6
AT064	20	8 73876 00062 3	CB15021	13	6 28903 14132 2	CB4004	17	6 28903 14079 3	FC-TRI-RP	12	1 87691 00052 3
AT065	20	8 73876 00063 0	CB15024	13	6 28903 14293 3	CB4005	17	6 28903 14055 7	GB2BIT	15	0 45622 02556 7
AT066	20	8 73876 00064 7	CB15025	13	6 28903 14029 8	CB4008	6	6 28903 14080 9	GB3ELZ	15	0 45622 07188 5
AT067	20	8 73876 00065 4	CB15026	13	6 28903 14134 9	CB4009	6	6 28903 14081 6	GBELAT	15	0 45622 02557 4
AT068	21	8 73876 00171 5	CB15026M	13	6 28903 14294 0	CB4010	6	6 28903 14082 3	GBH2	15	0 45622 07559 9
AT069	20	8 73876 00073 9	CB15027	13	6 28903 14135 6	CB4011	6	6 28903 14083 0	GBH3	15	0 45622 04786 6
AT070	21	8 73876 00072 2	CB15028	17	6 28903 14181 3	CB4012	6	6 28903 14084 7	GBH4	15	0 45622 04787 3
AT071	21	8 73876 00070 8	CB15031	14	6 28903 14038 0	CB4013	6	6 28903 14085 4	GBMBH143	15	0 45622 02561 1
AT072	20	8 73876 00167 5	CB15032	16	6 28903 14115 8	CB4014	6	6 28903 14086 1	HO4105	8	0 41072 04105 8
AT073	21	8 73876 00076 0	CB15033	16	6 28903 14136 3	CB4015	6	6 28903 14087 8	HO4120	8	0 41072 04120 1
AT074	21	8 73876 00077 7	CB15059	13	6 28903 14232 2	CB4016	6	6 28903 14088 5	HO4155	8	0 41072 04155 3
AT075	20/21	8 73876 00165 1	CB15060	13	6 28903 14219 3	CB4017	6	6 28903 14089 2	HO4165	8	0 41072 04165 2
AT076	21	8 73876 00074 6	CB15068	9	6 28903 14215 5	CB4018	6	6 28903 14298 8	HO4199	8	0 41072 04199 7
AT077	20/21	8 73876 00164 4	CB15069	9	6 28903 14265 0	CB4019	6	6 28903 14299 5	HO4205	8	0 41072 04205 5
AT078	21	8 73876 00075 3	CB15110	6	6 28903 14018 2	CB4020	6	6 28903 14300 8	HO4505	8	0 41072 04505 6
AT079	20/21	8 73876 00163 7	CB15111	6	6 28903 14071 7	CB4021	6	6 28903 14301 5	HO4630	8	0 41072 04610 7
AT080	21	8 73876 00057 9	CB15112	6	6 28903 14072 4	CB4100	18	6 28903 14061 8	HO6100	2	0 41072 06100 1
AT081	21	6 28903 14284 1	CB15113	6	0 99922 39716 9	CB4101	18	6 28903 14062 5	HO6500	5	0 41072 06500 9
AT082	20	8 73876 00069 2	CB15114	6	0 99922 39134 1	CB4102	18	6 28903 14063 2	IW19	NS	0 38548 00019 0
AT083	20	8 73876 00068 5	CB15115	6	6 28903 14268 1	CBL002	24	6 28903 14144 8	IW2011102	NS	0 38548 06504 5
AT084	20	8 73876 00067 8	CB15250	17	6 28903 14042 7	CBL003	24	6 28903 14145 5	IW2014100	NS	0 38548 06481 3
AT085	20	8 73876 00066 1	CB16180	3	6 28903 14137 0	CBL004	24	6 28903 14146 2	IW2031314DS	NS	0 38548 10143 3
AT090	21	8 73876 00041 8	CB16181	3	6 28903 14138 7	CBL005	24	6 28903 14147 9	IW2035201	NS	0 38548 06536 6
AT090A	21	8 73876 00170 5	CB16184	3	0 99922 35218 2	CBL007	24	6 28903 14148 6	IW2035203	NS	0 38548 06358 0
AT091	21	8 73876 00168 2	CB16185	3	6 28903 14043 4	CBL008	24	6 28903 14149 3	IW2035207	NS	0 38548 06542 7
AT092	20	8 73876 00166 8	CB16186	3	6 28903 14044 1	CBL009	24	6 28903 14150 9	IW2073113	NS	0 38548 08906 5
AT093	20	8 73876 00078 4	CB16187	3	0 99922 35219 9	CBL010	24	6 28903 14153 0	IW2081200	NS	0 38548 01820 1
CB001	5	6 28903 14230 8	CB16190	1	6 28903 14045 8	CBL011	24	6 28903 14154 7	IW2082200	NS	0 38548 01821 8
CB002	15	6 28903 14198 1	CB16191	1	6 28903 14046 5	CBL012	24	6 28903 14302 2	IW2083200	NS	0 38548 01829 4
CB003	15	6 28903 14199 8	CB16192	1	6 28903 14047 2	CBL013	24	6 28903 14151 6	IW2084100	NS	0 38548 01825 6
CB004	15	6 28903 14200 1	CB16200	1	6 28903 14048 9	CBL020	24	6 28903 14161 5	IW2084200	NS	0 38548 02225 3
CB006	15	6 28903 14201 8	CB16210	1	6 28903 14118 9	CBL021	24	6 28903 14155 4	IW2084400	NS	0 38548 01827 0
CB007	15	6 28903 14228 5	CB16211	1	6 28903 14119 6	CBL022	24	6 28903 14156 1	IW2089100	NS	0 38548 09321 5
CB009	15	6 28903 14285 8	CB16212	1	6 28903 14120 2	CBL023	24	6 28903 14157 8	IW3053003	NS	6 73765 09347 3
CB010	3	6 28903 14117 2	CB16214	1	6 28903 14121 9	CBL024	24	6 28903 14158 5	IW64310	NS	0 24721 50009 0
CB011	13	6 28903 14211 7	CB16230	2	6 28903 14220 9	CBL025	24	6 28903 14159 2	KFDW729	1	7 65139 43615 0
CB012	13	6 28903 14210 0	CB16231	2	6 28903 14221 6	CBL026	24	6 28903 14160 8	KFDW730	1	7 65139 43617 4
CB013	13	6 28903 14212 4	CB16232	2	6 28903 14222 3	CBL027	24	6 28903 14052 6	KFDW733	1	7 65139 43619 8
CB014	13	6 28903 14286 5	CB16233	2	6 28903 14223 0	CBN002	25	6 28903 14238 4	KFGG159	16	7 65139 90159 7
CB020	15	6 28903 14202 5	CB16234	2	6 28903 14224 7	CBN003	25	6 28903 14239 1	KFPC201	7	7 65139 33681 8
CB020CR	15	6 28903 14287 2	CB16235	1	6 28903 14254 4	CBN007	25	6 28903 14242 1	KFPC301	7	7 65139 31301 7
CB021	15	6 28903 14203 2	CB16236	1	6 28903 14225 4	CBN008	25	6 28903 14243 8	KFPC500	7	7 65139 99714 9
CB021CR	15	6 28903 14288 9	CB16237	1	6 28903 14226 1	CBN010	25	6 28903 14245 2	KFPC501	7	7 65139 31501 1
CB022	15	6 28903 14272 8	CB16238	1	6 28903 14227 8	CBN020	25	6 28903 14246 9	KFDW729PF	1	7 65139 44947 1
CB023	15	6 28903 14289 6	CB16260	1	6 28903 14030 4	CBN022	25	6 28903 14248 3	KFDW730PF	1	7 65139 44949 5
CB025	15	6 28903 14204 9	CB16261	1	6 28903 14031 1	CBN023	25	6 28903 14249 0	KFDW733PF	1	7 65139 44951 8
CB026	15	6 28903 14205 6	CB16262	1	6 28903 14032 8	CBN024	25	6 28903 14250 6	OF001	19	0 91511 20014 0
CB027	15	6 28903 14206 3	CB16263	1	6 28903 14049 6	CBN025	25	6 28903 14251 3	OF002	19	0 91511 60004 9
CB028	15	6 28903 14290 2	CB16265	1	6 28903 14050 2	CBN026	25	6 28903 14252 0	OF003	19	0 91511 60006 3
CB0											

Prod.	Page	UPC Code	Prod.	Page	UPC Code	Prod.	Page	UPC Code	Prod.	Page	UPC Code
OF010	19	0 91511 60041 4	ST0030-16	23	7 20361 00626 7	ST0715	28	7 78251 00609 5	TT0380	13	7 26372 00380 6
OF020	19	0 91511 60017 9	ST0031	23	7 20361 00606 9	ST0716	28	7 78251 00711 5	TT0385	5	7 26372 10385 8
OF021	19	0 91511 60019 3	ST0031-16	23	7 20361 00607 6	ST0717	28	7 78251 90030 0	TT0386	5	7 26372 11385 7
OF022	19	0 91511 60036 0	ST0032	23	7 20361 00008 1	ST0718	28	7 78251 01016 0	TT0390	5	7 26372 XXXXX X
OF023	19	0 91511 60037 7	ST0033	23	7 20361 00005 0	ST0719LH1	28	7 78251 00001 7	TT0390I	5	7 26372 XXXXX X
OF026	19	0 91511 60020 9	ST0034	23	7 20361 00173 6	ST0719LHF	28	7 78251 00001 7	TT0390R	5	7 26372 XXXXX X
OF027	19	0 91511 60031 5	ST0035	23	7 20361 00335 8	ST0719LS1	28	7 78251 00001 7	TT0391	5	7 26372 XXXXX X
OF028	19	0 91511 50127 8	ST0036	23	7 20361 00334 1	ST0719LS2	28	7 78251 00001 7	TT0540	13	7 26372 00540 4
OF030	19	0 91511 60024 7	ST0040	23	7 20361 00408 9	ST0719LS3	28	7 78251 00001 7	TT0550-080	13	7 26372 00480 1
S2000	9	6 28903 14067 0	ST0041	23	7 20361 00409 6	ST0719LS4	28	7 78251 00001 7	TT0550-100	13	7 26372 94100 9
S2001	9	6 28903 14305 3	ST0042	23	7 20361 00438 6	ST0719LS5	28	7 78251 00001 7	TT0550-120	13	7 26372 94120 7
S2010	9	6 28903 14166 0	ST0043	23	7 20361 00656 4	ST0723	28	7 42514 67100 9	TT0550-150	13	7 26372 94150 4
S284200UO-1	27	8 21812 02495 0	ST0044	23	0 00346 31937 8	ST0724	28	7 78251 13001 1	TT0550-180	13	7 26372 94180 1
S284240CO-1	27	8 21812 02497 4	ST0045	23	7 20361 00411 9	ST0727	30/31	6 28903 14262 9	TT0550-220	13	7 26372 94220 4
S6000	14	6 28903 14213 1	ST0046	23	7 20361 00416 4	ST0728	31	6 28903 14255 1	TT0540P	13	7 26372 06541 5
S6005	14	6 28903 14218 6	ST0060	17	0 84389 15850 7	ST0728A1	31	6 28903 14326 8	TT0590	10	7 26372 00590 9
S7130	27	8 21812 00028 2	ST0061	17	0 84389 15856 9	ST0728A2	31	6 28903 14327 5	TT0710	9	7 26372 20710 5
S7140	27	8 21812 00030 5	ST0074	22	0 51218 20801 6	ST0728A3	31	6 28903 14328 2	TT0751	5	7 26372 00751 4
S81005	27	8 21812 02566 7	ST0075	22	0 51218 20301 1	ST0728A4	31	6 28903 14329 9	TT0811	9	7 26372 00811 5
SK311-12	27	8 21812 75256 3	ST0076	22	0 51218 20002 7	ST0729	30	6 28903 14256 8	TT0825	22	7 26372 01825 1
SNF11/9L-12	27	8 21812 05223 6	ST0077	22	0 51218 21001 9	ST0729A1	30	6 28903 14330 5	TT0826	22	7 26372 01826 8
SNF11/10XL-12	27	8 21812 05224 3	ST0078	22	0 51218 21002 6	ST0729A2	30	6 28903 14331 2	TT0830	22	7 26372 10830 3
SNF14/8M-12	27	8 21812 72726 4	ST0080	22	0 51218 64121 9	ST0729A3	30	6 28903 14332 9	TT0831	22	7 26372 10831 0
SNF14/9L-12	27	8 21812 72842 1	ST0081	22	0 51218 64131 8	ST0729A4	30	6 28903 14333 6	TT0832	22	7 26372 10832 7
SNF14/10XL-12	27	8 21812 71599 5	ST0100	32	6 28903 14264 3	ST0730	30	6 28903 14257 5	TT0833	22	7 26372 10833 4
SNFKL13/9L-12	27	8 21812 79780 9	ST0101	33	6 28903 14345 9	ST0730A1	30	6 28903 14334 3	TT0847	8	7 26372 00849 8
SNFKL13/10XL-12	27	8 21812 79783 0	ST0102	33	6 28903 14307 7	ST0730A2	30	6 28903 14263 6	TT0848	8	7 26372 00848 1
S-T13501-12	27	8 21812 51197 9	ST0103	33	6 28903 14308 4	ST0731	31	6 28903 14263 6	TT0850	9	7 26372 00850 4
S-T65005-10	27	8 21812 68674 5	ST0104	33	6 28903 14310 7	ST0731A1	31	6 28903 14335 0	TT0851	9	7 26372 01851 0
S-T65015TCG-10	27	8 21812 78442 7	ST0105	33	6 28903 14269 8	ST0731A2	31	6 28903 14336 7	TT0861	26	7 26372 01860 2
SP080	11	6 28903 14167 7	ST0106	33	6 28903 14309 1	ST0733	32	6 28903 14259 9	TT0866	26	7 23513 11916 7
SP100	11	6 28903 14056 4	ST0108	33	6 28903 14270 4	ST0733-5	32	6 28903 14346 6	TT0867	26	7 23513 80009 6
SP120	11	6 28903 14057 1	ST0109	33	6 28903 14311 4	ST0733A1	32	6 28903 14261 2	TT0868	26	7 23513 12392 8
SP150	11	6 28903 14099 1	ST0109A	33	6 28903 14271 1	ST0733A1-5	32	6 28903 14338 1	TT0881	10	7 26372 01881 7
SP180	11	6 28903 14058 8	ST0110	33	6 28903 14312 1	ST0733A2	32	6 28903 14339 8	TT0881-BULK	10	7 26372 01881 7
SP220	11	6 28903 14168 4	ST0111	33	6 28903 14313 8	ST0733A3	32	6 28903 14340 4	TT0883F	10	7 26372 11883 8
SP224	11	6 28903 14191 2	ST0150	34	6 28903 14314 5	ST0735	29	7 78521 12006 7	TT0883F-BULK	10	7 26372 11883 8
SP225	11	6 28903 14192 9	ST0151	34	6 28903 14315 2	ST0736	29	7 78521 12008 1	TT0883M	10	7 26372 01883 1
SP226	11	6 28903 14193 6	ST0152	34	6 28903 14316 9	ST0737	29	7 78521 12007 4	TT0883M-BULK	10	7 26372 01883 1
SP227	11	6 28903 14194 3	ST0153	34	6 28903 14317 6	ST0738	29	7 78521 12010 4	TT0885	10	7 26372 01885 5
SP228	11	6 28903 14236 0	ST0154	34	6 28903 14318 3	ST0740	29	0 95641 01555 1	TT0885-BULK	10	7 26372 01885 5
SP335	11	6 28903 14187 5	ST0200	14	0 52837 00610 6	ST0741	29	0 95641 01556 8	TT0885-IND	10	7 26372 01885 5
SP336	11	6 28903 14188 2	ST0201	14	0 52837 00612 0	ST0742	29	0 95641 00060 1	TT0885F	10	7 26372 30885 7
SP337	11	6 28903 14189 9	ST0202	14	0 52837 02595 4	ST0742-5	29	0 95641 54005 3	TT0885F-BULK	10	7 26372 30885 7
SP338	11	6 28903 14190 5	ST0204	14	6 28903 14233 9	ST0743	29	0 95641 00058 8	TT0888F	10	7 26372 11888 3
SPB01	11	6 28903 14122 6	ST0205	14	6 28903 14237 7	ST0744	29	0 95641 54008 4	TT0888F-BULK	10	7 26372 11888 3
SPB02	11	6 28903 14097 7	ST0210	17	6 28903 14319 0	ST0745	29	0 95641 48604 7	TT0888F-IND	10	7 26372 11888 3
SPB04	11	6 28903 14126 4	ST0215	18	6 28903 14320 6	ST0745-5	29	0 95641 48605 4	TT0888M	10	7 26372 10888 4
SPB05	11	6 28903 14127 1	ST0221	17	6 28903 14100 4	ST0746	29	0 95641 01892 7	TT0888M-BULK	10	7 26372 10888 4
SPB06	11	6 28903 14098 4	ST0227	19	0 08023 02206 1	ST0747	29	0 95641 48608 5	TT0888M-IND	10	7 26372 10888 4
SPB07	11	6 28903 14123 3	ST0230	3	6 28903 14066 3	ST0748	29	0 95641 48610 8	TT0922	18	7 26372 00922 8
SPB08	11	6 28903 14124 0	ST0549	26	8 84206 90001 8	ST0760	38	6 28903 14216 2	TT0924	18	7 26372 00924 2
SPB09	11	6 28903 14125 7	ST0550	26	7 23513 77047 4	ST4001	23	6 26686 04005 5	TT0925	18	7 26372 00925 9
SPB10	11	6 28903 14261 2	ST0551	26	8 84206 90002 5	ST4001C	23	6 28903 14209 4	TT0927	18	7 26372 00927 3
SPB11	11	6 28903 14266 7	ST0552	26	8 84206 90000 1	ST4002	23	6 26686 04015 4	TT0928	18	7 26372 00928 0
SPB12	11	6 28903 14262 9	ST0554	26	8 84206 90004 9	ST4004	23	6 26686 04010 9	TT0929	18	7 26372 00929 7
SPB13	11	6 28903 14267 4	ST0580	26	6 28903 14321 3	ST4005	23	0 26686 04055 0	TT0932	18	7 26372 00932 7
SPP00	13	0 99922 35419 3	ST0581	26	6 28903 14322 0	ST4007	23	6 26686 04060 4	TT0933	18	7 26372 00933 4
SPP01	13	0 99922 35418 6	ST0582	26	6 28903 14195 0	ST4010	23	6 26686 04030 7	TT0943	18	7 26372 00943 3
SPP02	13	0 99922 35518 3	ST0583	26	6 28903 14217 9	ST4015	23	6 26686 04080 2	TT0970	22	7 26372 00970 9
SPP03	13	0 99922 35519 0	ST0584	26	6 28903 14323 7	ST5001	9	7 98304 00764 0	TT0971	22	7 26372 00971 6
SPP04	13	0 99922 39048 1	ST0585	26	6 28903 14128 8	ST5002	9	7 98304 02752 5	WT04001	18	0 49727 04001 2
SPS100	11	6 28903 14169 1	ST0586	26	6 28903 14129 5	ST5003	9	7 98304 16595 1	WT05002	2	0 49727 05002 8
SPS120	11	6 28903 14170 7	ST0587	26	6 28903 14130 1	ST5004	9	7 98304 02753 2	WT15001	19	0 49727 15001 8
SPS150	11	6 28903 14171 4	ST0588	26	6 28903 14131 8	ST5005	9	7 98304 16594 4	WT15007	19	0 49727 15007 0
SPS180	11	6 28903 14231 5	ST0589	26	6 28903 14132 5	ST6716A	18	7 27226 67168 4	WT42001	5	0 49727 42001 2
ST0001	16	6 28903 14065 6	ST0690	28	6 28903 14324 4	ST6716B	18	7 27226 67164 6	WT42002	5	0 49727 42002 9
ST0002	17	6 28903 14053 3	ST0691	28	6 28903 14325 1	ST6716L	18	7 27226 67162 2	WT42004	5	0 49727 42004 3
ST0003	17	6 28903 14090 8	ST0694	28	7 78251 56502 8	ST6716R	18	7 27226 67161 5	WT50031	7	0 49727 50031 8
ST0004	17	6 28903 14172 1	ST0695	28	7 78251 56525 7	ST6716S	18	7 27226 67163 9	WT54050	7	0 49727 54050 5
ST0005	17	6 28903 14173 8	ST0696	28	7 78251 56503 5	ST6730	20	8 55234 00101 5	WT58002	2	0 49727 58003 7
ST0006	22	6 28903 14174 5	ST0697	28	7 78251 56504 2	T3000	14	6 28903 14341 1	WT62005	8	0 28903 14347 3
ST0007	22	6 28903 14175 2	ST0699	28	6 28903 00699 0	T3001	14	6 28903 03001 8	WT62009	8	0 49727 62009 2
ST0010	5	0 99922 35617 3	ST0700	28	7 78251 12502 4	T3002	14	6 28903 03002 5	WT62011	8	0 49727 62011 5
ST0011	14	6 28903 14263 6	ST0701	28	7 78251 12525 3	T3003	14	6 28903 03003 2	WT62012	7	6 28903 14342 8
ST0012	16	6 28903 14196 7	ST0702	28	7 78251 12503 1	T3004	14	6 28903 03004 9	WT88007	3	0 49727 88007 6
ST0013	16	6 28903 14197 4	ST0703	28	7 78251 12504 8	T3005	14	6 28903 03005 6	WT88009	2	0 49727 88009 0
ST0014	16	6 28903 14207 0	ST0704	28	7 78251 12002 9	T3006	14	6 28903 03006 3			
ST0015	16	6 28903 14306 0	ST0705	28	7 78251 11503 2	T3007	14	6 28903 03007 0			
ST0021	23	7 20361 00622 9	ST0709	28	7 78						



**Distributors of Quality  
Drywall Tools and Accessories**

Telephone: 905-669-6336 • Fax: 905-669-9092  
Toll Free Telephone: 800-590-5799 • Toll Free Fax: 800-833-5487  
[www.wallboardtrim.com](http://www.wallboardtrim.com)