

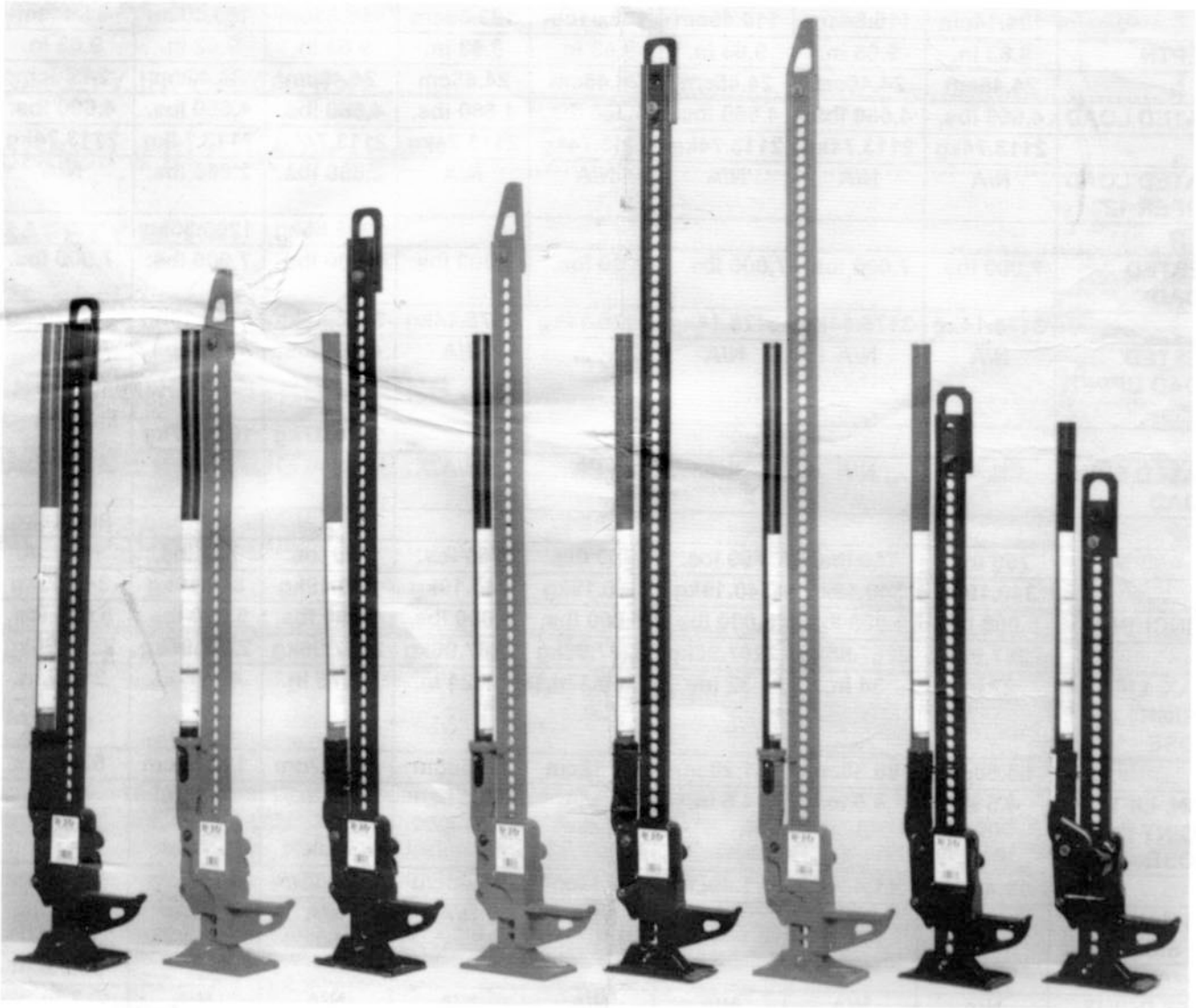

# Instruction Manual



HL-424

HL-425

HL-484

HL-485

HL-604

HL-605

HL-364

EJ-550

Hi-Lift Jack Company  
P.O.Box 228  
Bloomfield, IN 47424-0228USA

Toll Free: (800) 233-2051  
Direct: (812) 384-4441  
Fax: (812) 384-4592

<http://www.hi-lift.com>

MEETS APPLICABLE REQUIREMENTS OF ASME/ANSI B30.1-1992

## SPECIFICATIONS

	36" CAST/ STEEL	42" CAST	42" CAST/ STEEL	48" CAST	48" CAST/ STEEL	60" CAST	60" CAST/ STEEL	EJ CAST/ STEEL
WEIGHT	25.02 lbs.	27.78 lbs.	26.35 lbs.	28.16 lbs.	27.66 lbs.	31.31 lbs.	30.12 lbs.	25.72 lbs.
	11.35kg	12.60kg	11.95kg	12.77kg	12.55kg	14.20kg	13.66kg	11.67kg
WIDTH	5 in.	5 in.	5 in.	5 in.	5 in.	5 in.	5 in.	6.13 in.
	12.70cm	12.70cm	12.70cm	12.70cm	12.70cm	12.70cm	12.70cm	15.56cm
HEIGHT	41 in.	46 in.	43.5 in.	50.75 in.	48.75 in.	61.75 in.	59.25 in.	36 in.
	104.14cm	116.84cm	110.49cm	128.91cm	123.83cm	156.85cm	150.50cm	91.44cm
DEPTH	9.63 in.	9.63 in.	9.63 in.	9.63 in.	9.63 in.	9.63 in.	9.63 in.	9.63 in.
	24.46cm	24.46cm	24.46cm	24.46cm	24.46cm	24.46cm	24.46cm	24.46cm
RATED LOAD	4,660 lbs.	4,660 lbs.	4,660 lbs.	4,660 lbs.	4,660 lbs.	4,660 lbs.	4,660 lbs.	4,660 lbs.
	2113.74kg	2113.74kg	2113.74kg	2113.74kg	2113.74kg	2113.74kg	2113.74kg	2113.74kg
RATED LOAD UPPER 12"	N/A	N/A	N/A	N/A	N/A	2,660 lbs.	2,660 lbs.	N/A
						1206.55kg	1206.55kg	
TESTED LOAD	7,000 lbs.	7,000 lbs.	7,000 lbs.	7,000 lbs.	7,000 lbs.	7,000 lbs.	7,000 lbs.	7,000 lbs.
	3175.14kg	3175.14kg	3175.14kg	3175.14kg	3175.14kg	3175.14kg	3175.14kg	3175.14kg
TESTED LOAD UPPER 12"	N/A	N/A	N/A	N/A	N/A	4,000 lbs.	4,000 lbs.	N/A
						1814.37kg	1814.37kg	
RATED SIDE LOAD	N/A	N/A	N/A	N/A	N/A	N/A	N/A	2,000 lbs.
								907.18kg
CLAMPING	750 lbs.	750 lbs.	750 lbs.	750 lbs.	750 lbs.	750 lbs.	750 lbs.	750 lbs.
	340.19kg	340.19kg	340.19kg	340.19kg	340.19kg	340.19kg	340.19kg	340.19kg
WINCHING	5,000 lbs.	5,000 lbs.	5,000 lbs.	5,000 lbs.	5,000 lbs.	5,000 lbs.	5,000 lbs.	5,000 lbs.
	2267.96kg	2267.96kg	2267.96kg	2267.96kg	2267.96kg	2267.96kg	2267.96kg	2267.96kg
MAX. LIFT HEIGHT @ NOSE	27 in.	34 in.	32 in.	38.63 in.	37.24 in.	49.75 in.	48.25 in.	21.13 in.
	68.58cm	86.36cm	81.28cm	98.12cm	94.59cm	126.37cm	122.56cm	53.67cm
MIN. LIFT POINT @ NOSE	4.5 in.	4.5 in.	4.5 in.	4.5 in.	4.5 in.	4.5 in.	4.5 in.	4.5 in.
	11.43cm	11.43cm	11.43cm	11.43cm	11.43cm	11.43cm	11.43cm	11.43cm
LIFT HEIGHT @ SIDE	N/A	N/A	N/A	N/A	N/A	N/A	N/A	23.75 in.
								60.33cm
LIFT POINT @ SIDE	N/A	N/A	N/A	N/A	N/A	N/A	N/A	7 in.
								17.78cm

## TABLE OF CONTENTS

SPECIFICATIONS.....	2
WARRANTY.....	3
TO THE OWNER.....	4
GENERAL INFORMATION.....	4
SAFETY INFORMATION.....	4
CHOCK & BLOCK (STABILIZE).....	5
SAFETY DECAL.....	6
PARTS LIST.....	7
OPERATING INSTRUCTIONS.....	8
SERVICE INSTRUCTIONS.....	12
ACCESSORIES.....	14

---

---

### WARRANTY

#### Limited Warranty

Hi-Lift® Jack Company warrants the Hi-Lift® Jack for 12 months from the date of purchase, only to the original purchaser, against defective materials and workmanship. Return the Jack or parts thereof, transportation prepaid and with proof of purchase, to the Factory Service Department, Hi-Lift Jack Company, 46 West Spring Street, Bloomfield, IN 47424. This warranty is void if the Jack is modified, used beyond rated capacity, if an extender is used on the handle, or if the Jack is abused, misused, not maintained properly, or if non-Hi-Lift replacement parts are used. This warranty replaces all previous warranties and is the only warranty made by the Hi-Lift® Jack Company on this product. No other warranties, either verbal or written, are authorized. This warranty gives you specific legal rights. You may also have other legal rights that vary from state to state.

## TO THE OWNER

Thank you for purchasing this Hi-Lift® Jack. With proper use and care, your Jack will give you years of dependable service.

You can use the Hi-Lift® Jack in many ways, including:

Lifting stable loads.	Winching loads.
Clamping or spreading.	Stretching wire.
Raising vehicles or other mobile loads.	
<i>(when properly chocked and blocked (stabilized))</i>	

## GENERAL INFORMATION

All users must read and understand the instructions and warnings in this manual and on the safety label before using the Jack. Each user must use the Jack safely and maintain it properly. If any users are not fluent in English, have someone read the instructions to them. Manuals are also available in other languages.

If you have any questions about using the Jack safely or if you need a new label or manual, call (800) 233-2051. If you would rather write to us, our address is P.O. Box 228, Bloomfield, IN 47424.

Please store these instructions in the handle of your jack.

Use only genuine Hi-Lift® replacement parts. Using replacement parts not supplied by Hi-Lift® Jack Company will make the Jack unsafe to use. It will also void the warranty.

All through this manual, we use the term **IMPORTANT** whenever not following directions can cause damage to equipment. We use the terms **CAUTION**, **WARNING** and **DANGER** with the Safety-Alert Symbol to indicate how dangerous an action can be to you personally.

### **CAUTION**

: is used to remind you about good safety practices or to point out unsafe practices.

### **WARNING**

: is used to show a potential accident with serious injuries or death possible.

### **DANGER**

: is used to show the most serious kind of accident, which may cause serious injury or death.

## SAFETY INFORMATION

### INSPECTION BEFORE EACH USE

Inspect the Jack carefully before each use. Make sure the Jack is not damaged, badly worn, or missing parts. Check the climbing pins to make sure that they are not worn or damaged. Check the steel standard (bar) to make sure that it is straight and that nothing is blocking the holes. Do not use the Jack unless it is in good clean working condition. Do not use the jack unless it is properly lubricated. Using a jack that is not in good clean working condition or properly lubricated may cause serious injury. See "Lubricating the Jack."

### TRAINING

- ◆ Read this manual before use.
- ◆ Do not allow anyone who has not read this manual to use the jack.
- ◆ Do not allow anyone around or under a load supported only by the jack.

## OPERATIONAL SAFETY

### **⚠ CAUTION**

Jack is not self-lubricating. It will not operate safely without proper lubrication.

### **⚠ WARNING**

Do not use this Jack on curved or tubular vehicle bumpers. The vehicle could slip off the Jack and fall, causing serious injury or death. Use the Bumper Lift to lift most vehicles with curved or slotted bumpers. Do not raise inflated tire more than 2" (5 cm) above the ground. Never attempt to lift more than one wheel at a time. See Bumper Lift in "Accessories."

The working load of each chain or tow strap must be greater than the strength of the Jack. If a chain or tow strap breaks while winching, the load could shift or the chain or tow strap could snap back. When used as a winch, the top clamp will support up to 5,000 lbs. (2,273 kg). If you go over this limit, the top clamp could bend or break, causing the load to shift or the chain or tow strap to snap back. If that occurs it could result in damage or injury.

The maximum clamping force is 750 lbs. (340 kg). If you exceed this limit, the top clamp could bend or break, resulting in injury or damage.

### **⚠ DANGER**

Do not use the jack to support a load. Securely chock and block (stabilize) the load to be lifted. Never get under a raised load without properly chocking and supporting the load. If a raised load falls it can cause serious injury or death.

Always place the handle against the steel standard (bar) with the handle clip holding it up before moving the reversing latch. This will prevent the handle from moving up and down rapidly, which could cause serious injury or death if it comes into contact with any part of your body. Always keep your head out of the travel path of the handle.

**THIS JACK WILL NOT STABILIZE THE LOAD.** You must chock and block (stabilize) the load to prevent it from moving or falling. If a raised load falls, it can cause serious injury or death.

Lowering the load can be dangerous. Keep your head clear of the path of the handle. During lowering, the weight of the load pushes UP against the Jack's handle. If your hands slip off the handle, or if the handle is horizontal when you move the reversing latch, it may move up very quickly. If your head is in the handle's travel path, it could strike you, causing serious injury or death.

---

## CHOCK & BLOCK (STABILIZE)

A chock is a wedge for steadying a body and holding it motionless, or for preventing the movement of a wheel.

When you block a load, you secure and support a load that is being lifted. The block(s) or stabilizer(s) should have a weight capacity that is greater than the weight of the load which is being lifted.

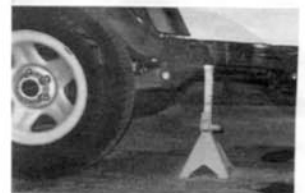



# SAFETY DECAL

**⚠ DANGER**



**To Avoid Serious Handle Impact Injury, Crushing Or Death**

- This Jack will not stabilize the load. You must chock and block (stabilize) the load securely to prevent it from falling.
- Do not use Jack to support a load. Never get under a raised load.
- Always clip the handle against the steel standard (bar) before moving the reversing latch.
- If your hands slip off the handle, or if the handle is horizontal when the reversing latch is moved down, it may move up very quickly. If your head is in the handle's travel path, it could strike you.

**⚠ WARNING**

**To Avoid Serious Crushing Injuries Or Death**

- Do not use this Jack on curved or tubular vehicle bumpers. The vehicle could slip off the Jack and fall, causing serious injury or death. Use the Bumper Lift to lift most vehicles with curved or slotted bumpers.
- Do not raise inflated tire more than 2" (5 cm) above the ground. Never attempt to lift more than one wheel at a time.
- If the shear bolt breaks, as it will at 7,000 lbs. (3,175 kg) use a Jack with a larger load capacity to lower the load safely to the ground.
- Do not replace the shear bolt while the Jack is under load.
- Do not replace the shear bolt with a bolt of greater strength. Always use a **W-115** shear bolt.
- The Jack must have a load on it (150 pounds or more) to lower step-by-step. Otherwise, the lifting mechanism will slide down to the base plate, 'dropping' your load.

MAXIMUM RATED LOAD IS 4,660 LBS. (2,273 kg) UP TO 48" (121 CM) TESTED TO 7,000 LBS. (3,175 kg). UPPER 12" OF 60" JACK IS RATED TO 2,660 LBS. (1,209 kg) ONLY, TESTED TO 4,000 LBS. (1,818 kg). TOP CLAMP LIMITED TO 750 LBS. (340 kg) CLAMPING AND 5,000 LBS. (2,273 kg) WINCHING. BUMPER LIFT ACCESSORY LIMITED TO 3,000 LBS. (1,360 kg).

MAXIMUM RATED LOAD FOR EQUIPMENT-AGRICULTURAL JACK SIDE LIFT IS 2,000 LBS. (910kg). Handle force required to raise 4,660 lbs. (2,273 kg) is 177 lbs. (80 kg) at 34" (86 cm) on the handle.

If operating instructions lost write to: **W-115** Jack Company, PO Box 228, Bloomfield, Indiana 47424,USA, or call 1-800-233-2051.

**⚠ CAUTION**

Read Instruction Manual Before Using Product. Jack is not self lubricating and will not operate safely without proper lubrication.

**BRIEF INSTRUCTIONS**

- Lubricate all working parts and edges of steel standard (bar). They should be free of rust, debris or other contaminants before using Jack.
- Place the Jack's base plate securely on a firm, level, dry surface with the steel standard (bar) pointing straight up. Lift the reversing latch until it locks in the UP position.
- Grab the handle or the handle socket and raise the lifting mechanism until the nose is completely and securely under the load.
- Grasp the handle firmly with both hands. Carefully pump the handle up and down to raise the load.
- The load will be raised on each **DOWN** stroke of the handle.
- When not operating the handle it should be in the full clipped up position parallel to the steel standard (bar).
- With the handle in the upright clipped position, move the reversing latch to the down position.
- Grasp the handle firmly with both hands. Carefully pump the handle up and down to begin lowering the load.
- The load will be lowered on each **UP** stroke of the handle.

**⚠ DANGER**



**To Avoid Serious Handle Impact Injury, Crushing Or Death**

- This Jack will not stabilize the load. You must chock and block (stabilize) the load securely to prevent it from falling.
- Do not use Jack to support a load. Never get under a raised load.
- Always clip the handle against the steel standard (bar) before moving the reversing latch.
- If your hands slip off the handle, or if the handle is horizontal when the reversing latch is moved down, it may move up very quickly. If your head is in the handle's travel path, it could strike you.

**⚠ CAUTION**

Read Instruction Manual Before Using Product. Jack is not self lubricating and will not operate safely without proper lubrication.

**BRIEF INSTRUCTIONS**

- Lubricate all working parts and edges of steel standard (bar). They should be free of rust, debris or other contaminants before using Jack.
- Place the Jack's base plate securely on a firm, level, dry surface with the steel standard (bar) pointing straight up. Lift the reversing latch until it locks in the UP position.
- Grab the handle or the handle socket and raise the lifting mechanism until the nose is completely and securely under the load.
- Grasp the handle firmly with both hands. Carefully pump the handle up and down to raise the load.
- The load will be raised on each **DOWN** stroke of the handle.
- When not operating the handle it should be in the full clipped up position parallel to the steel standard (bar).
- With the handle in the upright clipped position, move the reversing latch to the down position.
- Grasp the handle firmly with both hands. Carefully pump the handle up and down to begin lowering the load.
- The load will be lowered on each **UP** stroke of the handle.

**⚠ WARNING**

**To Avoid Serious Crushing Injuries Or Death**

- Do not use this Jack on curved or tubular vehicle bumpers. The vehicle could slip off the Jack and fall, causing serious injury or death. Use the Bumper Lift to lift most vehicles with curved or slotted bumpers.
- Do not raise inflated tire more than 2" (5 cm) above the ground. Never attempt to lift more than one wheel at a time.
- If the shear bolt breaks, as it will at 7,000 lbs. (3,175 kg) use a Jack with a larger load capacity to lower the load safely to the ground.
- Do not replace the shear bolt while the Jack is under load.
- Do not replace the shear bolt with a bolt of greater strength. Always use a **W-115** shear bolt.
- The Jack must have a load on it (150 pounds or more) to lower step-by-step. Otherwise, the lifting mechanism will slide down to the base plate, 'dropping' your load.

MAXIMUM RATED LOAD IS 4,660 LBS. (2,273 kg) UP TO 48" (121 CM) TESTED TO 7,000 LBS. (3,175 kg). UPPER 12" OF 60" JACK IS RATED TO 2,660 LBS. (1,209 kg) ONLY, TESTED TO 4,000 LBS. (1,818 kg). TOP CLAMP LIMITED TO 750 LBS. (340 kg) CLAMPING AND 5,000 LBS. (2,273 kg) WINCHING. BUMPER LIFT ACCESSORY LIMITED TO 3,000 LBS. (1,360 kg).

MAXIMUM RATED LOAD FOR EQUIPMENT-AGRICULTURAL JACK SIDE LIFT IS 2,000 LBS. (910kg). Handle force required to raise 4,660 lbs. (2,273 kg) is 177 lbs. (80 kg) at 34" (86 cm) on the handle.

If operating instructions lost write to: **W-115** Jack Company, PO Box 228, Bloomfield, Indiana 47424,USA, or call 1-800-233-2051.

## PARTS LIST

Following are the parts for all Hi-Lift Jacks. You can order parts from your dealer. You can also order parts directly from the Hi-Lift® Jack Company by calling (800) 233-2051, or (812) 384-4441 from outside the USA.

- 1 Top Clamp-Clevis Bolt
  - 2 Top Clamp-Clevis
  - 3 Steel Standard (Bar)
  - 4 Handle Spring Clip
  - 5 Steel Handle w/ Cotter Pin
  - 6 Handle Socket
  - 7 Pitman Pin
  - 8 Hex Bolt
  - 9 Pitman
  - 10 Small Runner
  - 11 Hi-Lift® Shear Bolt
  - 12 Foot Piece w/ Cotter Pin
  - 14 Climbing Pin Spring (2 required)
  - 15 Climbing Pin (2 required)
  - 16 Cross Pin (2 required)
  - 18 Reversing Switch Cam Bar and Spring
  - 19 Cap Screw w/ Washer
  - 20 Reversing Latch
  - 21 Reversing Switch Spring
  - 22 Large Runner
  - 23 Running Gear (assembled)
- Safety Label also available.

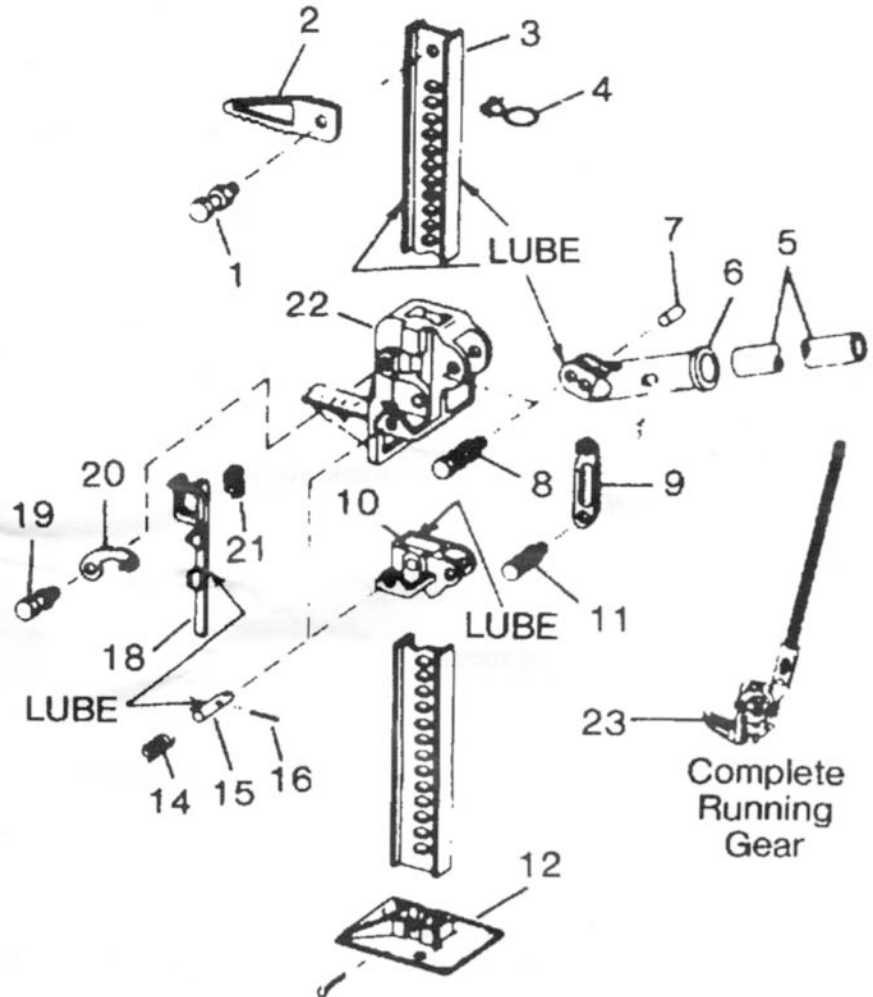

**Not pictured:**

E-J part #80-153

5/8" bent pin, cotter and swivel hub for Equipment Agricultural Jack.

EK-1 (FIX-IT KIT)-includes the following: two each of parts 14, 15, 16, one 11 & a tube of lubricant.

*Individual parts may vary on some models; part name and number remain the same.*

# OPERATING INSTRUCTIONS

## RAISING A STATIONARY LOAD

### DANGER

Do not use the jack to support a load. Securely chock and block (stabilize) the load to be lifted. Never get under a raised load without properly chocking and supporting the load. If a raised load falls it can cause serious injury or death.



### WARNING

Do not use this Jack on curved or tubular vehicle bumpers. The vehicle could slip off the Jack and fall, causing serious injury or death. Use the Bumper Lift to lift most vehicles with curved or slotted bumpers. Do not raise inflated tire more than 2" (5 cm) above the ground. Never attempt to lift more than one wheel at a time. See Bumper Lift in "Accessories."

1. Securely chock and block (stabilize) the load you are going to lift. This will prevent it from rolling or shifting as you lift it.
2. Keep the handle against the steel standard (bar) with the handle clip holding it when not lifting or lowering.
3. Place the Jack's base plate securely on a firm, level, and dry surface with the steel standard (bar) pointing straight up.
4. Lift the reversing latch until it locks in the **UP** position.
5. Grasp the handle or the handle socket and raise the lifting mechanism until the nose is completely and securely under the load.
6. Grasp the handle firmly with both hands. Carefully pump the handle up and down to raise the load. Do not use an extension on the handle.



### DANGER

Always place the handle against the steel standard (bar) with the handle clip holding it up before moving the reversing latch. This will prevent the handle from moving up and down rapidly, which could cause serious injury or death if it comes into contact with any part of your body. Always keep your head out of the travel path of the handle.





- The load will be raised on each **DOWN** stroke of the handle.
  - Watch the load and the Jack carefully. Stop jacking if either one starts to move. Do not continue raising the load unless it is safe to do so. When safe, stabilize and block the load.
7. When the load is raised to the desired height, place the handle in the upright clipped position against the steel standard (bar).
  8. Block the load securely.
  9. Lower the load onto the blocks.

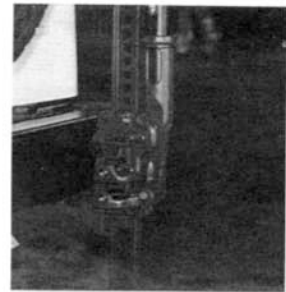

**IMPORTANT:**

Handle force required to raise 4,660 lbs. is 177 lbs. at 34" on the handle. Maximum rated load is 4,660 lbs. (2,273 kg) up to 48" (121 cm), tested to 7,000 lbs. (3175 kg). Upper 12" of 60" jack is rated to 2,660 lbs. (1,209 kg) only, tested to 4,000 lbs. (1,818 kg). If you overload the Jack during operation, the shear bolt (located in the lifting mechanism) will break. If the shear bolt breaks, as it will at 7,000 lbs. (3,175 kg), the load should be supported, but the Jack's handle will drop freely. Use a Jack with a larger load capacity to lower the load safely to the ground. Do not replace the shear bolt with a bolt of greater strength as this could cause the jack to fail and drop the load. Always use a shear bolt supplied by Hi-Lift<sup>®</sup> Jack Company. Do not replace the shear bolt while the Jack is under load.

**WORKING WITH A RAISED LOAD**



**DANGER**



**THIS JACK WILL NOT STABILIZE THE LOAD. You must chock and block (stabilize) the load to prevent it from moving or falling. If a raised load falls, it can cause serious injury or death.**

Always follow the rules below when working with a raised load:

- Chock and block (stabilize) the load to prevent it from moving or falling.
- Make sure the load cannot slip, roll away, or fall.
- Never go underneath a raised load supported with just a Jack.
- Never push a raised load off the Jack.
- Make sure everyone is clear of the load before lowering.

**ADDITIONAL INSTRUCTIONS FOR EQUIPMENT-AGRICULTURAL JACK**

1. When attaching the Equipment-Agricultural jack to equipment using tubular mounting brackets, always place lock-pin **COMPLETELY** through the holes in the tubular mounting bracket.
2. **ALWAYS** secure the lock-pin in the tubular brackets with the safety cotter pin.
3. Chock the equipment that you have attached the Equipment-Agricultural jack to before lifting with the Equipment-Agricultural jack.



Side lift is limited to 2,000 lbs. (907 kg)

## DANGER

Never work under raised equipment unless additional supports are used under the lifted equipment.



After you have properly hooked the raised equipment to a mobile vehicle, lower the lifting mechanism of the Equipment-Agricultural Jack to its base and move the reversing latch into the up position.

### LOWERING A LOAD

## DANGER

Lowering the load can be dangerous. Keep your head clear of the path of the handle. During lowering, the weight of the load pushes UP against the Jack's handle. If your hands slip off the handle, or if the handle is horizontal when you move the reversing latch, it may move up very quickly. If your head is in the handle's travel path, it could strike you, causing serious injury or death.



### IMPORTANT:

The Jack must have a load on it (150 pounds or more) to lower step-by-step. Otherwise, the lifting mechanism will slide down to the base plate, "dropping" your load.

1. Before you move the reversing latch down, clip the handle in the upright position against the steel standard (bar).
2. Move the reversing latch to the DOWN position.
3. Grasp the handle firmly with both hands. Carefully pump the handle up and down to begin lowering the load.
4. The load will be lowered on each **UP** stroke of the handle. If the Jack binds, see instructions on page 13.



## WINCHING OR CLAMPING WITH THE JACK

You may use this Jack as a winch or clamp. See the pictures on this page and follow these instructions:

### For Winching:

Make sure the top clamp is in line with the bar. Install one end of a chain or tow strap securely to the object to be winched, and securely attach the other end of the chain or tow strap to the top clamp of the Jack. Use a shackle if the chain or tow strap will not fit through the Top Clamp of the Jack. Take another chain or tow strap and secure one end to a fixed, stable object, and the other end around the lifting nose on the Jack (do not attach chain or shackle to bottom hole of the lifting nose). If the fixed object is a tree, follow Tread Lightly principles and use a tree strap.

Operate the Jack as you would for raising or lowering a load.



Also see PAGE 15 for the OFF-ROAD KIT, everything that you need to winch with the Hi-Lift Jack.

### **⚠ WARNING**

The working load of each chain or tow strap must be greater than the strength of the Jack. If a chain or tow strap breaks while winching, the load could shift or the chain or tow strap could snap back. When used as a winch, the top clamp will support up to 5,000 lbs. (2,273 kg). If you go over this limit, the top clamp could bend or break, causing the load to shift or the chain or tow strap to snap back. If that occurs it could result in damage or injury.



### For Clamping:

Loosen the top clamp bolt. Turn the top clamp 90° to the steel bar, and retighten the bolt. You can connect the top clamp anywhere along the steel standard (bar) to use the Jack as a clamp. Operate the Jack as you would for raising a load.

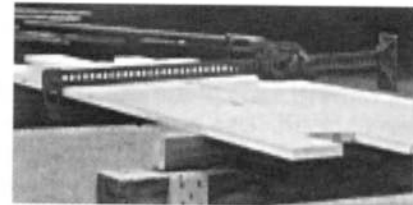

### **⚠ WARNING**

The maximum clamping force is 750 lbs. (340 kg). If you exceed this limit, the top clamp could bend or break, resulting in injury or damage.

# SERVICE INSTRUCTIONS

## STORING THE JACK

1. Place the handle in the upright clipped position against the steel standard (bar).
2. Raise the reversing latch until it locks in the UP position.
3. Store the Jack in an upright clipped position in a dry location, preferably indoors. If the Jack is stored outdoors, or is stored in a Loc-Rac or 4X4RAC, use a Jack protector. See "Accessories."

## STORING THE EQUIPMENT-AGRICULTURAL JACK

1. Pivot the Equipment-Agriculture jack to a horizontal position. Rest the steel handle of the Equipment-Agricultural jack on top of the steel (standard) bar.
2. Secure the jack in this position with the lock-pin through the holes in the tubular mounting bracket.
3. Secure the lock-pin in the tubular mounting brackets with the safety cotter pin.



## MAINTENANCE

If you use and maintain your Hi-Lift® Jack properly, it will give you many years of service. Follow these maintenance instructions carefully to keep your Jack in good working condition. Never perform maintenance on the Jack while it is under load.

## INSPECTION

Inspect the Jack thoroughly before each use. Make sure the Jack is not damaged, badly worn, or missing parts. Check the climbing pins to make sure that they are not worn or damaged. Check the steel standard (bar) to make sure that it is straight and that nothing is blocking the holes. Do not use the Jack unless it is in good, clean working condition and properly lubricated. See "Lubricating the Jack."

## CLEANING AND LUBRICATING THE JACK

If the moving parts of the jack or the steel standard (bar) are clogged, use air pressure, water pressure, or a stiff brush to clean. Use a non-flammable cleaning solvent or another good de-greaser to clean the Jack. Remove any existing rust, preferably with a penetrating lubricant. Then lubricate the Jack using white lithium grease, light penetrating oil, or a silicon or Teflon spray at the following points:

### Steel Bar:

Keep the front and back edges of the steel standard (bar) lightly lubricated and free from dirt and rust.

### Pitman Pin:

Keep the pitman pin lubricated or it will damage the handle socket and pitman.

### Shear bolt:

Keep the shear bolt clean and lubricated to keep it from wearing out.

### Climbing Pins and Springs:

Keep both climbing pins and springs lubricated and free from dirt and rust.

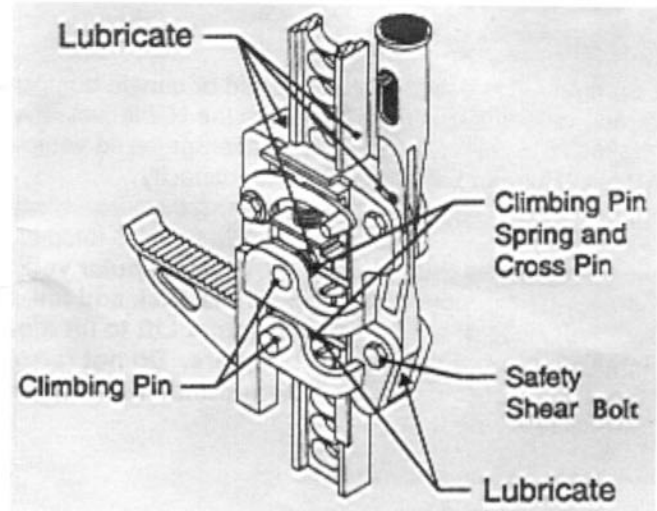

Do not use motor oil or grease to lubricate the jack.

## ⚠ CAUTION

**Jack is not self-lubricating. It will not operate safely without proper lubrication.**

### IF YOUR JACK BINDS

As your Jack becomes older, the climbing pins may start binding in the holes of the steel standard (bar). This will prevent the Jack from operating properly and safely. Rusty climbing pins, dirt, or a worn bar can cause binding. Clean and lubricate the lifting mechanism. Test the Jack by jacking it up without a load. If the binding continues, send it to the address below for repair. If your Jack binds while under a load, use a jack with equal or larger load capacity to lower the load safely to the ground. Repeat the steps in this paragraph to the binding Jack.

### REPAIRING THE JACK

When repairing your Jack use only genuine Hi-Lift® parts. **Using replacement parts not supplied by Hi-Lift® Jack Company will make the Jack unsafe to use.**

Hi-Lift® Jack Company will repair a damaged Jack. Pack the Jack in a carton and send prepaid to:

Hi-Lift® Jack Company  
Factory Service Department  
46 West Spring Street  
Bloomfield, Indiana 47424

The repaired Jack will be returned to you U.S. Postal, UPS, RPS or C.O.D. for the cost of replacement parts, service, and transportation. We will notify you with an estimate before we do any work.



## ACCESSORIES

### BUMPER LIFT

The Bumper Lift is designed to fit slotted or curved bumpers for quick and easy lifting. When used with the Hi-Lift jack, the Bumper Lift makes raising one wheel of most average-sized vehicles an easy task. Bumper Lift has a 3,000-lb. capacity.

**Do not use this Jack on curved or tubular vehicle bumpers. The vehicle could slip off the Jack and fall, causing serious injury or death. Use the Bumper Lift to lift most vehicles with curved or slotted bumpers. Do not raise inflated tire more than 2" (5 cm) above the ground. Never attempt to lift more than one wheel at a time.**

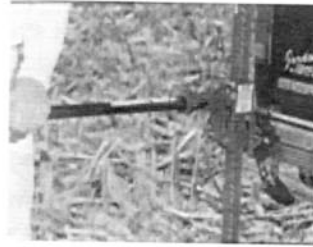

BL-250

### JACK PROTECTOR

Protects your Hi-Lift Jack from weather, mud, dirt and sand.

Made of durable vinyl-coated nylon, the Jack Protector is waterproof, as well as mildew and decay resistant. Drawstring closure.

Fits 36", 42", 48", and 60" Hi-Lift Jacks.

(Note: All working parts of the 60" Jack are protected. However, the footpiece and 5" of steel bar are exposed.)

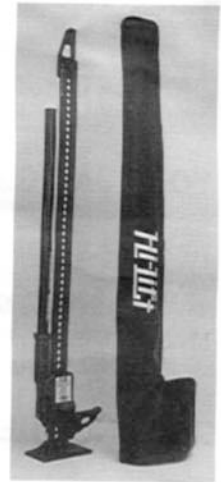

JP-350

### FIX-IT-KIT

Keep your Hi-Lift jack operating trouble-free. The Fix-it-Kit has all the principal parts for servicing all Hi-Lift jack lifting units.

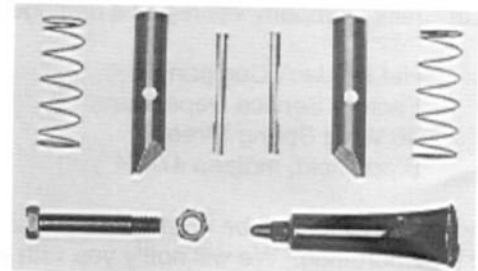

FK-1

## ACCESSORIES

### LOG-RAC

A convenient mounting and locking device for storage of your Hi-Lift Jack.

Installation is simple. It can be mounted horizontally or vertically, with or without a jack protector. Your Hi-Lift Jack is mounted in the Loc-Rac to deter theft. It also places the jack in an easy to reach location.

Loc-Rac is manufactured of high quality steel. Lock is included.

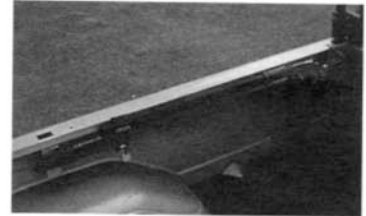
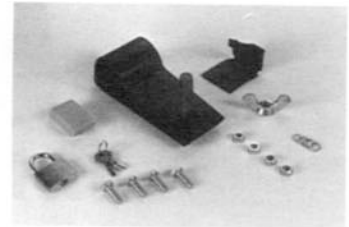

LR-200

### 4XRAC

The Hi-Lift 4XRAC is designed for serious off-roaders who are looking for an easy, inexpensive way to stow their Hi-Lift jack in a convenient, secure location.

Each kit contains 2 mounting brackets, 2 mounting bracket caps, a Velcro strap for securing the Hi-Lift's handle, and all necessary mounting hardware.

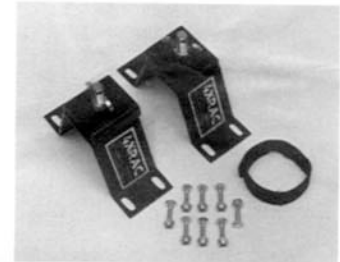

4X400

### Off-Road Base

The Off-Road Base alleviates jack sinkage on soft ground.

This lightweight and durable base is constructed to withstand the high weight capacities of the Hi-Lift Jack.

**NEW!**

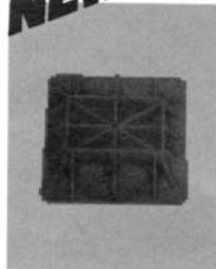

ORB

### Off-Road Kit

The OFF-ROAD KIT contains everything needed to winch with the Hi-Lift Jack (user to provide tow strap) in one convenient case.

Kit contains:  
1- Custom Nose Attachment  
1- 8ft. Tree Saver Strap  
1- Pair/Hi-Lift Gloves  
Hardware and Carrying Case

**NEW!**



ORK



Hi-Lift Jack Company  
P.O.Box 228  
Bloomfield, IN 47424-0228USA

Toll Free: (800) 233-2051  
Direct: (812) 384-4441  
Fax: (812) 384-4592

<http://www.hi-lift.com>

MEETS APPLICABLE REQUIREMENTS OF ASME/ANSI B30.1-1992

### EC Declaration of Conformity

<b>Manufacturer:</b> (must always be filled in)
Company Name: HI-LIFT JACK COMPANY
Address: Bloomfield, Ind. 47424, U.S.A.
Tel.: 812.38.444.41

<b>Representative:</b> (only to be filled in if representative is established in the community)
Company Name: Arbil Automotive
Address: Bromley Street
Lye, Stourbridge, West Midlands, UK DY9 8HS
Tel.: 00.44.1384.424007

hereby declare that

<b>Machine:</b> Lifting Jack
Name: HI-LIFT
Type, serial no., year of construction:

- A: was manufactured in conformity with the provisions in the COUNCIL DIRECTIVE of 14 June 1989 on mutual approximation of the laws of the Member States on the safety of machines (89/392/EEC as amended by directive 91/368/EEC) with special reference to Annex 1 of the Directive on essential safety and health requirements in relation to the construction and manufacture of machines<sup>①</sup>

<b>Position:</b> CEO
Name: Eric Harrah
Company: HI-LIFT JACK COMPANY