

NUMBERS, LETTERS & SIGNS



Catalog

Numbers & Letters

Residential & Commercial Signs

Traffic & Safety Products

Driveway/Safety Markers & Reflectors

Aquatic Signs

Farm & Ranch Signs



www.hy-ko.com

Buy with Confidence from Hy-Ko Products.

Design and manufacture Numbers, Letters and Signs, Key Accessories and Keys. That's what we do. And we're specialists at it. Which is why we've grown from our simple beginnings in 1949 into the industry leader with the broadest lines that are unmatched in sizes, materials, messages, and applications.

Whether it's numbers for a house address, sale signs for a home or car, or OSHA safety postings for a factory, you'll find it in this catalog.

No matter your selection, you can be assured of quality. Because of our never-ending commitment to quality improvement... weatherability, durability and longevity have become the hallmarks of Hy-Ko products.

We're also known for our value. The use of the latest methods and equipment to increase productivity and reduce inefficiencies result in price points that consistently please our customers.

These are some of the reasons for our "Vendor of Choice" status at leading hardware, home center, drug, grocery, and mass merchant retailers.

And, there's more!



Where Innovation is Constant.

New product development is important to Hy-Ko and we continually introduce new products into the retail marketplace. Our sensitivity to consumers' ever-changing tastes and emerging trends enables us to provide you with tomorrow's new products today. The result are SKUs that sell – and sell fast – for maximum profitability.

Where Merchandising Programs are Designed to Fit the Need

What are your space and product selection requirements? That's where we start in working with our customers to arrive at merchandising programs that will work for them. The answer may lie in our wide selection of displays distinctly designed for our product lines, including end cap, wing panel, wire rack, corrugated, or special pallet programs.

Or, the solution may rest in a custom sliding-panel, carousel, flatwall, or bay program from Hy-Ko. Regional tailoring by type of store and/or by size of store may also be part of the mix.

No matter the program, our goal remains the same: optimize retail space and maximize customer-appeal to ensure that you receive the best return on your investment.



Going Global? So are We.

Whatever the message, we speak your language... with product packages in trilingual format for the French and Spanish speaking markets. We offer a wide selection of signs for those markets as well. To get more information on these products, please contact our Customer Service Department.

Where Responsive Service and Support are Guaranteed.

Hy-Ko takes pride in its order fill rate, and carries a full inventory of items in this catalog. You can expect prompt delivery soon after you place your order.

If you have questions on products, pricing, shipping mode or any other purchase matter, just give our customer service representatives a call. Well trained and knowledgeable, they'll make it easy for you to do business with us.

Likewise, you can count on us for merchandising support with point-of-purchase materials, ads and digital images.



Where you can find the Latest Up-To-Date Information.

www.hy-ko.com

To direct consumers to your retail network, we've incorporated a local retail outlet locator on our website's home page.

It's also where you can find current information on our newest products and current promotions, as well as view our on-line catalog. Visit us anytime, 24 hours a day, at www.hy-ko.com!

Where Orders can be Placed Conveniently.

Hy-Ko's Customer Service Department is ready to help you place your order. We offer five easy ways to order:

Phone: 330.467.7446 • 800.292.0550

(Monday - Friday, 8:30am - 6:00pm, Eastern Time)

Fax: 330.467.7442

(24 hours a day, seven days a week)

E-Mail: cservice@hy-ko.com

(Checked frequently during the work day)

EDI - Electronic Data Interchange

(24 hours a day, seven days a week)

Mail: Send your completed order form (see page 98) to:

Hy-Ko Products Company







60 Meadow Lane, Northfield, OH 44067-1415

P.S. Looking for a Special Sign?

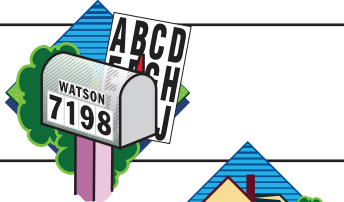
Hy-Ko's Custom Sign Services can help. We can create signs to your customers' requirements.

Call us today to find out how you can add this valuable service to your store offerings!

Table of Contents

	<p>Numbers, Letters & Address Plaques <i>House numbering kits, mailbox address kits; packaged self-adhesive vinyl, brass decorative, aluminum & reflective numbers & letters, stencils & more</i></p>	<p>6-27</p>
	<p>Residential & Commercial Signs <i>Property, lawn, novelty, real estate, braille, ADA, office, bilingual signs & more</i></p>	<p>28-47</p>
	<p>Sell-It-Yourself Signs, Pennant Flags, Stakes, Frames & Accessories <i>Property, auto and general "for sale" signs & more</i></p>	<p>48-55</p>
	<p>Traffic and Safety Signs, Tapes & Cones <i>OSHA, parking lot, reflective, emergency & glow-in-the-dark signs, floor stands, traffic safety cones & safety tape</i></p>	<p>56-65</p>
	<p>Driveway / Safety Markers & Reflectors <i>Fiberglass and aluminum driveway markers, safety markers and assorted reflectors</i></p>	<p>66-70</p>
	<p>Farm & Ranch Signs <i>Property, safety, bilingual, novelty and regulatory</i></p>	<p>71-75</p>
	<p>Aquatic Safety Signs <i>Swimming pool & spa, regulatory and emergency CPR</i></p>	<p>76-77</p>

Metric Conversion Table (Approximations)			
Unit (U.S.)		Metric	
1 inch	x 2.54	=	2.54 centimeters (cm)
1 foot	x 0.305	=	.305 meters (m)
3 feet	x 0.305	=	.915 meters (m)
Unit (U.S.)		Metric	
1 lb.(pound)	x 453.6	=	453.6 grams (g)
1 lb.(pound)	x .4536	=	.4536 kilograms (kg)

Copyright 2012 Hy-Ko Products Company. All rights reserved. Printed in the United States of America.

All material represented in this catalog is subject to change without notice, including but not limited to pricing, product specifications, designs or availability. All trademarks are the property of their respective holders.

Please contact Hy-Ko Products Company to receive the most current information.

Numbers & Letters



Choose from our extensive selection of number & letter products including:

Some consumers see addresses and name identifications as mere requirements. Others view them as another means of expressing their individualities. From Hy-Ko's extensive number and letter products, you can make selections to satisfy all of your customers.

Choose from individual or packaged numbers and letters as small as 3/8" to as large as 7", in aluminum, vinyl, brass, or simulated wood, in various type styles and colors.

Traditional Aluminum Numbers & Letters **8**



Die-Cut, Self-Adhesive Reflective Vinyl & Die-Cut Vinyl Numbers & Letters **9-10**



Packaged Numbers & Letters **11-14**



Decorative House Numbers & Letters **15-18**



Number & Letter Stencils **19**



A maximum amount of product in a minimum amount of space has been the secret to the success of Hy-Ko Products' The "Slider" gondola program. The compact, 8 ft. wide x 6 ft. high merchandiser features a planogram assortment of over 600 of Hy-Ko's best selling numbers, letters and signs.

1½" Press-On Gold Aluminum Numbers, Letters and Symbols

- No maintenance – will not rust
- Self-adhesive
- Available: Numbers 0 thru 9; A thru Z; Symbols (Period, Hyphen, Blank and Comma)



GR-10

SIZE: 1.13" number or letter on 1.5" panel
 PRODUCT SIZE: 1.06" x 1.88"
 PACK: 10 Each
 WEIGHT: .02 Lbs.

3½" Press-On Gold Aluminum Numbers, Letters and Symbols

- No maintenance – will not rust
- Self-adhesive
- Available: Numbers 0 thru 9; A thru Z; Symbols (Period, Hyphen, Blank and Comma)

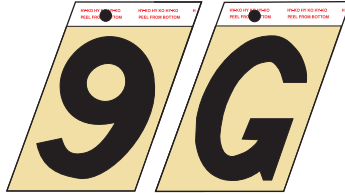

GG-25

SIZE: 3.13" number or letter on 3.5" panel
 PRODUCT SIZE: 2.44" x 4"
 PACK: 10 Each
 WEIGHT: .16 Lbs.

3" Black Vinyl Die-Cut Self-Stick Numbers and Letters

- Weather-resistant
- Self-adhesive
- Available: Numbers 0 thru 9; A thru Z; Symbol Panel (Period, Hyphen, Blank and Ampersand)



30400

SIZE: 3" nominal number/letter
 PANEL SIZE: 2.50" x 4.00"
 PACK: 10 Each
 WEIGHT: .06 Lbs.

3" White Vinyl Die-Cut Self-Stick Numbers and Letters

- Weather-resistant
- Self-adhesive
- Available: Numbers 0 thru 9; A thru Z; Symbol Panel (Period, Hyphen, Blank and Ampersand)

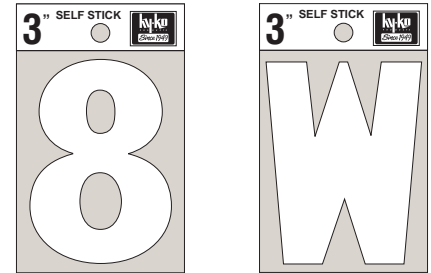

30500

SIZE: 3" nominal number/letter
 PANEL SIZE: 2.50" x 4.00"
 PACK: 10 Each
 WEIGHT: .06 Lbs.

3¼" Bend & Peel Reflective Vinyl Numbers, Letters and Symbols

- Weather-resistant
- Water-resistant
- Self-adhesive
- Available: Numbers 0 thru 9; A thru Z; Symbol Panel (Period, Hyphen, Blank and Ampersand)



PS-20

SIZE: 3.25" nominal number/letter
 PANEL SIZE: 1.75" x 4.50"
 PACK: 10 Each
 WEIGHT: .04 Lbs.

1" Bend & Peel Reflective Vinyl Numbers, Letters and Symbols

- Weather-resistant
- Self-adhesive
- Available: Numbers 0 thru 9; A thru Z; Symbols (Period, Hyphen, Blank and Ampersand)

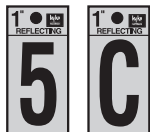

RV-15

SIZE: 1" nominal number/letter on 1.5" panel
 PRODUCT SIZE: 1" x 2"
 PACK: 10 Each
 WEIGHT: .02 Lbs.

2" Bend & Peel Reflective Vinyl Numbers, Letters and Symbols

- Weather-resistant
- Self-adhesive
- Available: Numbers 0 thru 9; A thru Z; Symbols (Period, Hyphen, Blank and Ampersand)

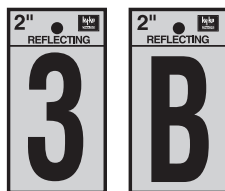

RV-25

SIZE: 2" nominal number/letter on 2.38" panel
 PRODUCT SIZE: 1.50" x 3"
 PACK: 10 Each
 WEIGHT: .04 Lbs.

3" Bend & Peel Reflective Vinyl Numbers, Letters and Symbols

- Weather-resistant
- Self-adhesive
- Available: Numbers 0 thru 9; A thru Z; Symbols (Period, Hyphen, Blank and Ampersand)
- Meets size requirements for boat registration and identification numbers

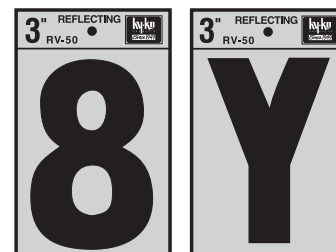

RV-50

SIZE: 3" nominal number/letter on 3.25" panel
 PRODUCT SIZE: 2.50" x 4"
 PACK: 10 Each
 WEIGHT: .06 Lbs.

4" Bend & Peel Reflective Vinyl Numbers

- Weather-resistant
- Self-adhesive
- Available: Numbers 0 thru 9
- Meets size requirements for boat registration and identification numbers



RV-60

SIZE: 4" nominal number on 4.5" panel
 PRODUCT SIZE: 2.50" x 5"
 PACK: 10 Each
 WEIGHT: .08 Lbs.

5" Bend & Peel Reflective Vinyl Numbers

- Weather-resistant
- Self-adhesive
- Available: Numbers 0 thru 9
- Meets size requirements for boat registration and identification numbers



RV-70

SIZE: 5" nominal number on 5.63" panel
 PRODUCT SIZE: 3" x 6.25"
 PACK: 10 Each
 WEIGHT: .10 Lbs.

6" Bend & Peel Reflective Vinyl Numbers

- Weather-resistant
- Self-adhesive
- Available: Numbers 0 thru 9
- Meets size requirements for boat registration and identification numbers



RV-80

SIZE: 6" nominal number on 7" panel
 PRODUCT SIZE: 3.50" x 8"
 PACK: 10 Each
 WEIGHT: .16 Lbs.

3/8" Gold Embossed Polyester Packaged Numbers and Letters

- Self-adhesive
- Numbers 0 thru 9; Letters A thru Z



MM-1

SIZE: 5/16" number or letter on 3/8" panel
 CARD SIZE: 5.59" x 5.81"
 PACK: 10 Each
 WEIGHT: .24 Lbs.

1" Gold Polyester Packaged Numbers and Letters

- Self-adhesive
- Numbers 0 thru 9; Letters A thru Z



MM-2

SIZE: 7/8" number or letter on 1" panel
 CARD SIZE: 7.72" x 11.66"
 PACK: 10 Each
 WEIGHT: .78 Lbs.



MM-12

SIZE: 7/8" number or letter on 1" panel
 CARD SIZE: 5.25" x 9"
 PACK: 10 Each
 WEIGHT: .56 Lbs.

2" Gold on Black Polyester Packaged Letters

- Self-adhesive
- Letters A thru Z, dash, comma, period



MM-3L

SIZE: 1 3/4" letter on 2" panel
 CARD SIZE: 7.72" x 11.66"
 PACK: 10 Each
 WEIGHT: 1.08 Lbs.



MM-13L

SIZE: 1 3/4" letter on 2" panel
 CARD SIZE: 5.25" x 9"
 PACK: 10 Each
 WEIGHT: .86 Lbs.

2" Gold on Black Polyester Packaged Numbers

- Self-adhesive
- Numbers 0 thru 9

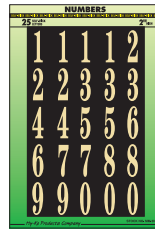

MM-3N

SIZE: 1 3/4" number on 2" panel
 CARD SIZE: 7.72" x 11.66"
 PACK: 10 Each
 WEIGHT: .78 Lbs.



MM-13N

SIZE: 1 3/4" number on 2" panel
 CARD SIZE: 5.25" x 9"
 PACK: 10 Each
 WEIGHT: .58 Lbs.

Quadrilingual packaging, featuring English, French, Portuguese and Spanish, is now available in a small space-saving package size in these number and letter selections:

Part#	Description	Page
MM-12	1" gold numbers & letters	11
MM-13L	2" gold letters	11
MM-13N	2" gold numbers	11
MM-14N	3" black and white numbers	11
MM-15N	3" gold numbers	11
MM-16	1" black & white numbers & letters	12
MM-17L	2" black & white letters	12
MM-17N	2" black & white numbers	12
MM-21	1" reflective black & white numbers & letters	12
MM-22N	2" reflective black & white numbers	12
MM-23N	3" reflective black & white numbers	12

3" Black & White Vinyl Packaged Letters

- Self-adhesive
- Letters A thru Z, dash, period



MM-4L

SIZE: 3" letter on 3 1/4" panel
 CARD SIZE: 7.72" x 11.66"
 PACK: 10 Each
 WEIGHT: 1.82 Lbs.

3" Black & White Vinyl Packaged Numbers

- Self-adhesive
- Numbers 0 thru 9

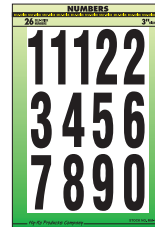

MM-4N

SIZE: 3" number on 3 1/4" panel
 CARD SIZE: 7.72" x 11.66"
 PACK: 10 Each
 WEIGHT: 1.08 Lbs.



MM-14N

SIZE: 3" number on 3 1/4" panel
 CARD SIZE: 5.25" x 9"
 PACK: 10 Each
 WEIGHT: .94 Lbs.

3" Gold on Black Polyester Packaged Numbers

- Self-adhesive
- Numbers 0 thru 9



MM-5N

SIZE: 3" number on 3 1/4" panel
 CARD SIZE: 7.72" x 11.66"
 PACK: 10 Each
 WEIGHT: .84 Lbs.



MM-15N

SIZE: 3" number on 3 1/4" panel
 CARD SIZE: 5.25" x 9"
 PACK: 10 Each
 WEIGHT: .82 Lbs.

1" Black & White Vinyl Packaged Numbers and Letters

- Self-adhesive
- Numbers 0 thru 9; Letters A thru Z



MM-6

SIZE: 3/4" number or letter on 1" panel
 CARD SIZE: 7.72" x 11.66"
 PACK: 10 Each
 WEIGHT: .78 Lbs.



MM-16

SIZE: 3/4" number or letter on 1" panel
 CARD SIZE: 5.25" x 9"
 PACK: 10 Each
 WEIGHT: .62 Lbs.

2" Black & White Vinyl Packaged Letters

- Self-adhesive
- Letters A thru Z, dash, comma, period



MM-7L

SIZE: 1 3/4" letter on 2" panel
 CARD SIZE: 7.72" x 11.66"
 PACK: 10 Each
 WEIGHT: 1.06 Lbs.



MM-17L

SIZE: 1 3/4" letter on 2" panel
 CARD SIZE: 5.25" x 9"
 PACK: 10 Each
 WEIGHT: .62 Lbs.

2" Black & White Vinyl Packaged Numbers

- Self-adhesive
- Numbers 0 thru 9

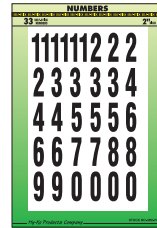

MM-7N

SIZE: 1 3/4" number on 2" panel
 CARD SIZE: 7.72" x 11.66"
 PACK: 10 Each
 WEIGHT: .82 Lbs.



MM-17N

SIZE: 1 3/4" number on 2" panel
 CARD SIZE: 5.25" x 9"
 PACK: 10 Each
 WEIGHT: .94 Lbs.

3/8" Black & White Vinyl Packaged Numbers and Letters

- Self-adhesive
- Numbers 0 thru 9; Letters A thru Z



MM-8

SIZE: 5/16" number or letter on 3/8" panel
 CARD SIZE: 5.59" x 5.81"
 PACK: 10 Each
 WEIGHT: .24 Lbs.

5" Black & White Vinyl Packaged Numbers

- Self-adhesive
- Numbers 0 thru 9



MM-9N

SIZE: 5" number on 5 1/2" panel
 CARD SIZE: 7.72" x 11.66"
 PACK: 10 Each
 WEIGHT: 2.08 Lbs.

1" Black on Reflective White Vinyl Packaged Numbers & Letters

- Fully-reflective white panel
- Self-adhesive
- Numbers 0 thru 9; Letters A thru Z



MM-21

SIZE: 3/4" number or letter on 1" panel
 CARD SIZE: 5.25" x 9"
 PACK: 10 Each
 WEIGHT: .64 Lbs.

2" Black on Reflective White Vinyl Packaged Numbers

- Fully-reflective white panel
- Self-adhesive
- Numbers 0 thru 9



MM-22N

SIZE: 2" number on 3 1/4" panel
 CARD SIZE: 5.25" x 9"
 PACK: 10 Each
 WEIGHT: .68 Lbs.

3" Black on Reflective White Vinyl Packaged Numbers

- Fully-reflective white panel
- Self-adhesive
- Numbers 0 thru 9



MM-23N

SIZE: 3" number on 3 1/4" panel
 CARD SIZE: 5.25" x 9"
 PACK: 10 Each
 WEIGHT: 1.02 Lbs.

3/4" Black & White Vinyl Packaged Numbers

- Self-adhesive
- Consecutive numbers 1 thru 100

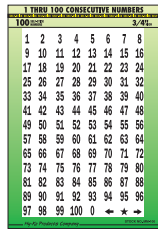

MM-100

SIZE: 1/2" number on 3/4" panel
 CARD SIZE: 7.72" x 11.66"
 PACK: 10 Each
 WEIGHT: .82 Lbs.

3" White on Black Vinyl Packaged Numbers & Letters

- Self-adhesive
- Meets size requirements for boat registration and identification numbers
- Numbers 0 thru 9; Letters A thru Z



MM-244-W

SIZE: 3" number or letter on 3 3/8" panel
 CARD SIZE: 7.50" x 12"
 PACK: 10 Each
 WEIGHT: 3.52 Lbs.

3/4" Embossed Polyester Initial-It Letters

- Self-adhesive
- Initial letters A thru Z



SI-2 (Satin Silver)

SIZE: 1/2" letter on 3/4" panel
 CARD SIZE: 5.81" x 8.13"
 PACK: 10 Each
 WEIGHT: .42 Lbs.

3" Black on White Vinyl Packaged Numbers & Letters

- Self-adhesive
- Meets size requirements for boat registration and identification numbers
- Numbers 0 thru 9; Letters A thru Z



MM-144-B

SIZE: 3" number or letter on 3 3/8" panel
 CARD SIZE: 7.50" x 12"
 PACK: 10 Each
 WEIGHT: 3.52 Lbs.

4" White Packaged Numbers, Letters & Symbols

- Removable, Low-Tac self-adhesive
- Apply to inside window surface

4" Numbers, Letters & Symbols

Números, letras y símbolos de 10,2 cm
 Numéros, lettres et symboles de 10,2 cm

Post your phone number and price in car window to help sell your vehicle!
 ¡Coloque su número de teléfono y el precio en la ventana del carro para ayudarle a venderlo!
 Mettez votre numéro de téléphone et le prix sur la fenêtre de la voiture pour vous aider à vendre votre véhicule!

Removable Adhesive
 Adhésivo Removible
 Adhésif Démontable

4" Numbers, Letters & Symbols
 Números, letras y símbolos de 10,2 cm
 Numéros, lettres et symboles de 10,2 cm

Features:		Caratteristiche:		Caractéristiques:	
• 4" wide numbers, letters & symbols on sign boards	• Removable adhesive material	• Removable adhesive material	• Removable adhesive material	• Removable adhesive material	• Removable adhesive material
• Apply to inside window surface		• Apply to inside window surface		• Apply to inside window surface	
• Durable, long-lasting	• Easy to install	• Durable, long-lasting	• Easy to install	• Durable, long-lasting	• Easy to install
• Removable adhesive material	• Removable adhesive material	• Removable adhesive material	• Removable adhesive material	• Removable adhesive material	• Removable adhesive material

contiene: contiente: contiene:

1000	1000	1000
1000	1000	1000
1000	1000	1000
1000	1000	1000

HY-KO
 1000

610

SIZE: 4" die-cut numbers, letters & symbols
 CARD SIZE: 9.50" X 12.50"
 PACK: 10 Each
 WEIGHT: 2.25 Lbs.



Packaged Self-Stick Vinyl Numbers & Letters

- Vinyl die-cut sheets
- 3 Sizes – 1", 2" and 3"
- 3 Colors – red, white, and black

1"

30003 (Red)
30013 (White)
30033 (Black)

CARD SIZE: 7.81" x 11.63"
PACK: 10 Each
WEIGHT: .60 Lbs.



2"

30004 (Red)
30014 (White)
30034 (Black)

CARD SIZE: 7.81" x 11.63"
PACK: 10 Each
WEIGHT: .60 Lbs.

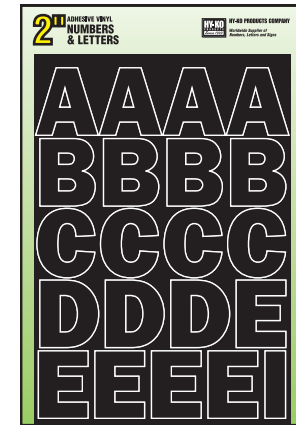
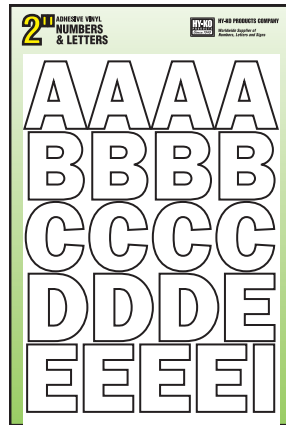
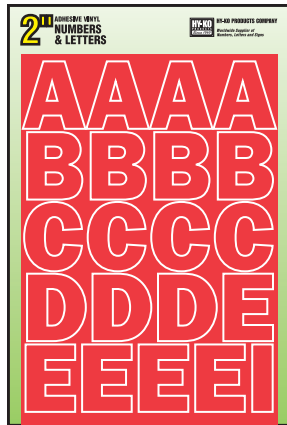

3"

30005 (Red)
30015 (White)
30035 (Black)

CARD SIZE: 7.81" x 11.63"
PACK: 10 Each
WEIGHT: .60 Lbs.



Prism Self-Adhesive Numbers & Letters

- Vinyl die-cut sheets
- 1", 2" and 3" sizes
- Silver and red prism-patterned colors

CARD SIZE: 7.75" x 11.70"
 PACK: 5 Each
 WEIGHT: .39 Lbs.



MM-31
1" Numbers & Letters

MM-32L
2" Letters

MM-32N
2" Numbers

MM-33L
3" Letters

MM-33N
3" Numbers

Silver Prism

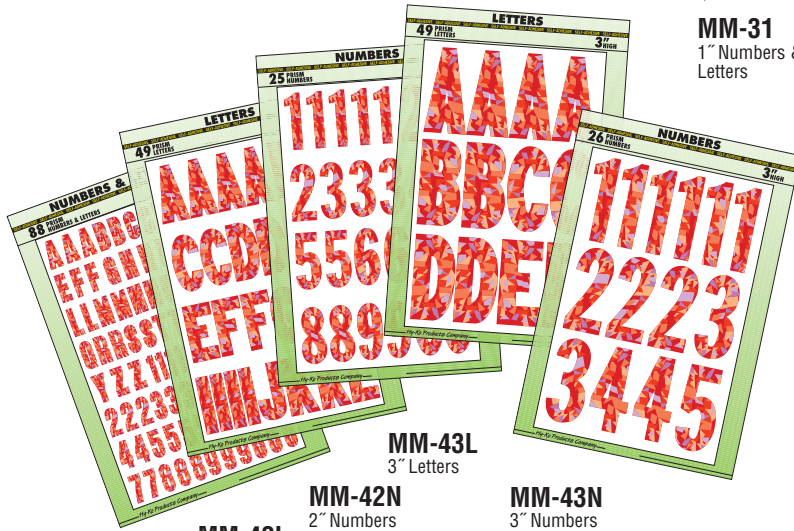

MM-41
1" Numbers & Letters

MM-42L
2" Letters

MM-42N
2" Numbers

MM-43L
3" Letters

MM-43N
3" Numbers

Red Prism

2 3/8" Molded, Self-Adhesive Packaged Numbers

- 30 dimensional numbers
- Permanent, self-adhesive backed, suitable for outdoor use (for mailboxes, posts, etc.)
- Easy-to-apply to plastic, glass, acrylic, or stainless steel

CARD SIZE: 7.75" x 11.75"
 PACK: 2
 WEIGHT: .95 Lbs.



MM-200B



MM-200W



3" Simulated Gold Die Cast Aluminum Address Numbers

- Gold finish – looks like brass
- Mounting nails included
- Numbers 0 thru 9



DCG-3

CARD SIZE: 2.88" x 6.75"
 PACK: 10 Each
 WEIGHT: .52 Lbs.

3" White Die Cast Aluminum Address Numbers

- White hammered finish
- Mounting nails included
- Numbers 0 thru 9



DCW-3

CARD SIZE: 2.88" x 6.75"
 PACK: 10 Each
 WEIGHT: .52 Lbs.

3 1/2" Black Die Cast Aluminum Address Numbers

- Black hammered finish
- Mounting nails included
- Numbers 0 thru 9



DC-3

CARD SIZE: 2.88" x 6.75"
 PACK: 10 Each
 WEIGHT: .52 Lbs.

4 1/2" Black Die Cast Aluminum Address Numbers

- Black pebbled finish
- Mounting nails included
- Numbers 0 thru 9

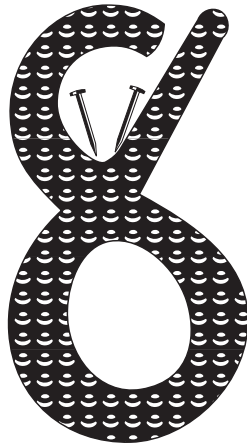

DC-4

CARD SIZE: 2.88" x 6.75"
 PACK: 10 Each
 WEIGHT: .56 Lbs.

4 1/2" Black Die Cast Aluminum Address Numbers

- Black hammered finish
- Mounting nails included
- Numbers 0 thru 9



DC-5

CARD SIZE: 3.88" x 6.88"
 PACK: 10 Each
 WEIGHT: .98 Lbs.

4" Black 3-D Plastic House Numbers

- Weather-resistant
- Mounting nails included
- Numbers 0 thru 9

PN-29

CARD SIZE: 2.88" x 6.75"
PACK: 10 Each
WEIGHT: .25 Lbs.

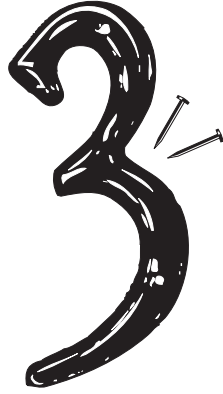

7" Simulated Wood-Grain Numbers & Letters

- Easy to install and finish
- Can be used indoors or outdoors for homes, offices, schools, or other commercial buildings
- Numbers 0-9; Letters A-Z



GB-7

CARD SIZE: 7.75" x 9.75"
PACK: 3 Each
WEIGHT: .82 Lbs.

6" White Plastic House Numbers

- Solid white high-impact styrene
- Meets many local "911" codes
- Mounting screws included
- Numbers 0 thru 9

30300 Series

CARD SIZE: 5.75" x 8.13"
PACK: 5 Each
WEIGHT: .10 Lbs.



6" Black Plastic House Numbers

- Solid black high-impact styrene
- Meets many local "911" codes
- Mounting screws included
- Numbers 0 thru 9

30200 Series

CARD SIZE: 5.75" x 8.13"
PACK: 5 Each
WEIGHT: .10 Lbs.



3 1/2" Reflective Aluminum House Numbers

- Black aluminum panel with white reflective numeral
- Mounting nails included
- Numbers 0 thru 9

CA-25

SIZE: 3.5" number on 5" panel
 CARD SIZE: 2.88" x 6.75"
 PACK: 10 Each
 WEIGHT: .28 Lbs.

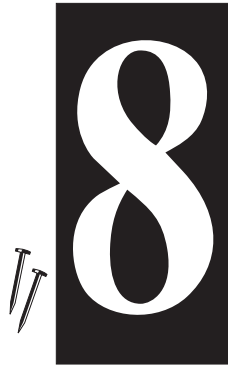

4" Reflective Plastic House Numbers

- Black plastic with white reflective numeral
- Mounting nails included
- Numbers 0 thru 9

30600 Series

CARD SIZE: 2.88" x 6.75"
 PACK: 10 Each
 WEIGHT: .25 Lbs.

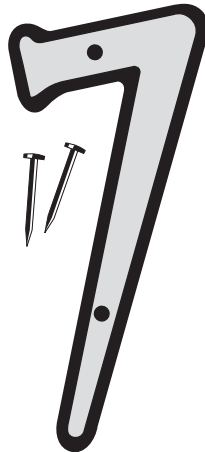

5" Reflective Hi-Visibility House Numbers

- High-grade retroreflective material
- Mount with nails or screws
- Numbers 0 thru 9

920 Series

SIZE: 5 1/4" number on 6" plate
 CARD SIZE: 3 1/8" x 7 1/2"
 PACK: 5 Each



* Based on comparisons of engineering grade reflective materials, at a distance of 400 ft.

4" Solid Brass House Numbers

- Attractive solid polished brass
- Mounting nails included
- Numbers 0 thru 9

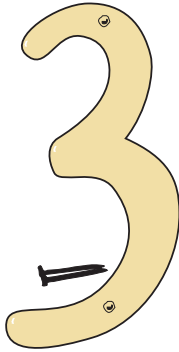

BR-40

CARD SIZE: 2.88" x 6.75"
PACK: 10 Each
WEIGHT: 1.14 Lbs.

4" Solid Brass Letters

- Attractive solid polished brass
- Mounting nails included
- Numbers A thru Z

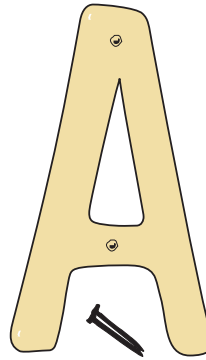

BR-41

CARD SIZE: 2.88" x 6.75"
PACK: 1 Each
WEIGHT: .10 Lbs.

4" Solid Brass 3-D House Numbers

- Attractive solid polished brass
- Mounting screws included
- Numbers 0 thru 9



BR-90

CARD SIZE: 2.88" x 6.75"
PACK: 5 Each
WEIGHT: .90 Lbs.

5" Solid Brass 3-D House Numbers

- Attractive solid polished brass
- Mounting screws included
- Numbers 0 thru 9



BR-50

CARD SIZE: 4.75" x 8"
PACK: 5 Each
WEIGHT: 1.75 Lbs.





Carded Number & Letter Stencils

- Reusable, blister-carded stencils
- Water-resistant, stencil board
- Includes Numbers 0 thru 9; A thru Z; Symbols (Period, Hyphen, Comma, ¢, &, \$, and one extra A, E, O, R, and S)

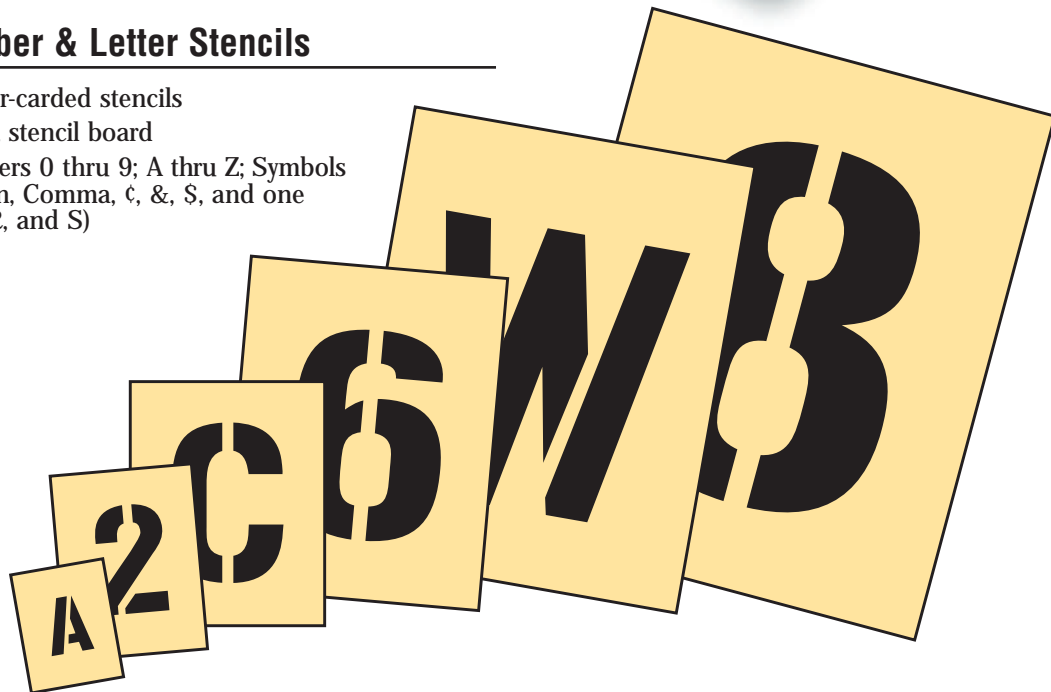

ST-1

STENCIL SIZE: 1"
 CARD SIZE: 3.75" x 5.88"
 PACK: 6 Each
 WEIGHT: .92 Lbs.

ST-2

STENCIL SIZE: 2"
 CARD SIZE: 3.75" x 6.88"
 PACK: 6 Each
 WEIGHT: 1.62 Lbs.

ST-3

STENCIL SIZE: 3"
 CARD SIZE: 4.75" x 7.88"
 PACK: 6 Each
 WEIGHT: 2.50 Lbs.

ST-4

STENCIL SIZE: 4"
 CARD SIZE: 5.75" x 9.88"
 PACK: 6 Each
 WEIGHT: 4.12 Lbs.

ST-5

STENCIL SIZE: 5"
 CARD SIZE: 5.75" x 10.88"
 PACK: 6 Each
 WEIGHT: 5.12 Lbs.

ST-6

STENCIL SIZE: 6"
 CARD SIZE: 6.75" x 11.88"
 PACK: 6 Each
 WEIGHT: 6.54 Lbs.

For additional stencil products, see page 65.

Prestige Address Plaques, House Numbers and Address Kits



Prestige address plaques and house numbers offer your customers the choice and high-quality selection they want. Bring the Prestige collection into your store with one of Hy-Ko's expertly designed merchandising assortments to ensure you customers have the best shopping experience.

Hy-Ko's Prestige address plaques offer an elegant accent to any home. Crafted in a variety of popular shapes, sizes and colors, these address plaques offer complete versatility to coordinate with any color scheme.



Choose from our extensive selection of address plaques and related products including:

Prestige Address Plaques & House Numbers
22-24



Prestige Tile Address Plaques & Ceramic Numbers
25



Prestige Architectural Series
26



Other Address Plaques & Kits
27



Prestige Plaques & House Numbers Program

Hy-Ko's 4 ft. Prestige assortment features a variety of address plaques and house number styles. This selection includes 4" and 5" house numbers in quality finishes such as brass and satin nickel. Rounding out the assortment are decorative plaques and ceramic tile house numbers.



Prestige Address Plaques

Hy-Ko's Prestige address plaques offer an elegant accent to any home. Crafted in the traditional oval and the popular arched rectangle, these weather-resistant address plaques feature a reversible background that can be either off-white or black to coordinate with any color scheme.

- Packaged in a durable clamshell that shows off the dimensional details and finish of the frame.
- Include mounting hardware for quick and easy installation.
- Oval plaques also contain a template to align numbers perfectly when installing house numbers onto the address plaque.

Oval Address Plaques



AK-450
Brushed Gold Finish

FRAME SIZE: 15.75" x 9"
CARD SIZE: 16.875" x 11.625"
PACK: 3
WEIGHT: 4.88 Lbs.



AK-451
Satin Nickel Finish

FRAME SIZE: 15.75" x 9"
CARD SIZE: 16.875" x 11.625"
PACK: 3
WEIGHT: 4.88 Lbs.

Rectangular Address Plaques



AK-460
Matte Black Finish

FRAME SIZE: 15.75" X 6.25"
CARD SIZE: 16.875" x 8.75"
PACK: 3
WEIGHT: 3.94 Lbs.



AK-461
Off-White Finish

FRAME SIZE: 15.75" X 6.25"
CARD SIZE: 16.875" x 8.75"
PACK: 3
WEIGHT: 3.94 Lbs.



Prestige 4" Premium House Numbers and Letters

Prestige 4" premium house numbers and letters can be used with the Prestige address plaques or mounted directly to the home. These dimensional, high quality numbers are available in four popular finishes: polished brass, old world bronze, satin nickel and brushed brass.

- Select letters are also available in polished brass and old world bronze.
- Attractive, clamshell packaging is molded to each character.
- Include mounting hardware for quick and easy installation.

4" Polished Brass Numbers and Letters



BR-42PB CARD SIZE: 2.938" x 6.875"
 PACK: 3
 WEIGHT: .60 Lbs.

4" Old World Bronze Numbers and Letters



BR-42OWB CARD SIZE: 2.938" x 6.875"
 PACK: 3
 WEIGHT: .60 Lbs.

4" Satin Nickel Numbers



BR-43SN CARD SIZE: 2.938" x 6.875"
 PACK: 3
 WEIGHT: .60 Lbs.

4" Brushed Brass Numbers



BR-43BB CARD SIZE: 2.938" x 6.875"
 PACK: 3
 WEIGHT: .60 Lbs.

Prestige 5" Premium House Numbers

Prestige 5" premium house numbers can add a stylish touch to any home. These dimensional, high quality house numbers are available in our two most popular finishes: polished brass and satin nickel.

- Can also be used with the oval address plaques for three-number addresses.
- Attractive clamshell packaging is molded to each character.
- Include mounting hardware for quick and easy installation.

5" Polished Brass Numbers

0123456789

BR-51PB

CARD SIZE: 4.875" x 7.875"
PACK: 3
WEIGHT: 1.00 Lbs.

5" Satin Nickel Numbers

0123456789

BR-51SN

CARD SIZE: 4.875" x 7.875"
PACK: 3
WEIGHT: 1.00 Lbs.



Prestige Tile Address Plaques and Ceramic Numbers

Hy-Ko's Prestige tile address plaques and ceramic numbers are sure to please your customers. The address plaques are manufactured in weather-resistant, black powder-coated steel.

- Plaques are securely packaged with mounting hardware on a full color card that allows consumers to see and touch the decorative frame.

Prestige ceramic tile numbers can be used with the tile address plaques or mounted directly to the home.

- Feature a decorative trim that can be completed with the full and half tile borders.
- 4" Number on 6" tile.
- Firmly packaged in a clamshell with mounting hardware for quick and easy installation.



Tile Number Address Plaques



AK-TL3 Holds up to 3 tile numbers.
 SIZE: 13.5" x 11.25"
 CARD SIZE: 15.75" x 14"
 PACK: 3
 WEIGHT: 6.56 Lbs.



AK-TL5 Holds up to 5 tile numbers.
 SIZE: 19.5" x 11.75"
 CARD SIZE: 20.875" x 14.875"
 PACK: 3
 WEIGHT: 8.63 Lbs.

4" Numbers on 6" Ceramic Tiles



TL-40 NUMBER SIZE: 4"
 TILE SIZE: 3" x 6"
 PACK: 3
 WEIGHT: 1.13 Lbs.

6" Architectural Series

0123456789

FM-6 Series

CARD SIZE: 2.938" x 6.875"
 PACK: 3
 WEIGHT: .99 Lbs.



Prestige 6" Architectural House Numbers

Prestige 6" Architectural house numbers feature a distinctive mounting system that allows the numbers to flush mount or stand slightly away from the wall to create a 3-D shadow effect.

- Crafted in a modern, easy-to-read font with a satin-black finish.
- Large size meets many 911 community requirements.
- Attractive clamshell packaging is molded to each character.
- Include mounting hardware and a floating-mount template for quick and easy installation.



Natural Wood Address Plaque

- Holds up to five 4" numbers
- Paint, stain or varnish to protect wood finish
- Can mount horizontally or vertically

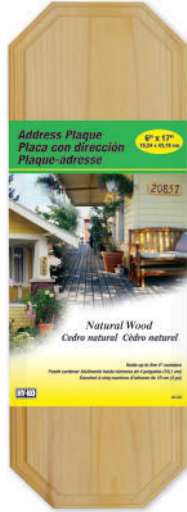

AK-300

SIZE: 6" x 17"
 PACK: 3 Each
 WEIGHT: 3.00 Lbs.

All-in-One Address Plate

- Stylish, black plastic frame
- 24 – 4" self-adhesive die-cut numbers included
- Mounting screws included

AK-400

FRAME SIZE:
 PACK: 3 Each
 WEIGHT: 1.85 Lbs.



911 Address Plate

- Predrilled, heavy-duty plate can be attached for horizontal or vertical applications
- Addressplate and house numbers combine to improve visibility
- A generous supply of 3" reflective house numbers are included in each package

911

SIZE: 4.625" x 18" plate
 CARD SIZE: 5.625" x 19.5"
 PACK: 5 Each
 WEIGHT: 4.00 Lbs.



Mailbox Name & Address Kit

- Durable plastic name plate
- Includes mounting hardware and vinyl self-adhesive numbers and letters



AK-270

CARD SIZE: 7" x 18"
 PACK: 5 Each
 WEIGHT: 1.38 Lbs.

House Numbering Kits

- Wrought-iron frame
- Heavy-duty number plate
- Vinyl, self-adhesive numbers

500-GF

CARD SIZE: 17.50" x 23.25"
 PACK: 5 Each
 WEIGHT: 12.54 Lbs.

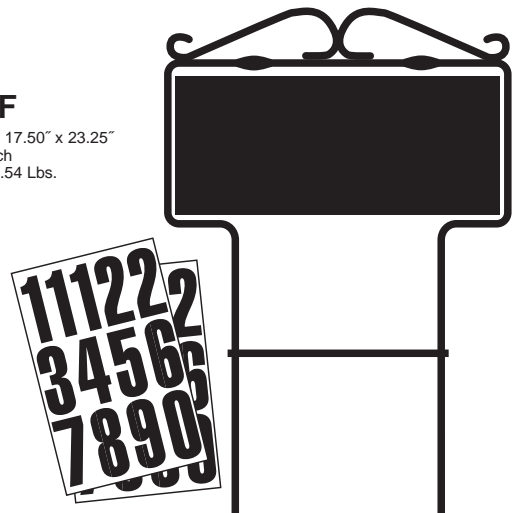

Residential & Commercial Signs and Accessories



Choose from our extensive selection of signs and related products including:

“For Sale” and “For Rent” are the first types of signs that come to mind for house and apartment use. But there are also property owners who want privacy-protecting signs as well as signs that will help limit their legal liability. And, retail and office establishments require an assortment of interior and exterior signs that inform or provide directions to visitors.

Satisfy all of your customers’ needs with Hy-Ko’s residential and commercial products, available in a wide range of sizes, consumer-preferred wordings, eye-catching colors, and weather-resistant materials.



Hy-Ko’s carousel program maximizes the selling space within your height and width requirements. For example, our 8 ft. display with four, three-paneled, fully-revolving carousels holds up to 16 feet of product!

General Signs
30-33



Posted Property Signs
33-34



Real Estate Signs and Accessories
35-39



Aluminum Signs
40-41



Interior Signs
42-44



Specialty Kits & Bilingual Signs
45-47



Plastic Hy-Glo Signs

- Weather-resistant
- Durable
- Bright, attention-getting colors



3001



3002



3003



3004



3005



3006



3007



3010



3011



3012



3013



3014



3016



3018



3020



3021



3022



3023



3024



3025



3027



3028



3030



3031



3032



3033



3034



3036



3041
(multicolored sign)



3042 (blank)



3045 (two-sided)



3048

3045 (two-sided sign)
 SIZE: 8.50" X 12"
 PACK: 10 Each
 WEIGHT: .60 Lbs.

SIZE: 8.50" X 12" except where noted
 PACK: 10 Each

Plastic Signs

- Weather-resistant
- Durable
- Bright, attention-getting colors



SIZE: 8.50" X 12"
 PACK: 10 Each
 WEIGHT: .60 Lbs.

Corrugated Plastic Sign

- Weather-resistant
- Blank sign can be customized to customer's needs
- Includes metal sign stakes



SIZE: 14" X 18"
 PACK: 3 Each

MYO-1

Plastic Patriotic Sign

- Weather-resistant
- Durable
- Bright, attention-getting colors

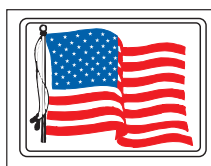

SIZE: 9" X 12"
 PACK: 10 Each

3039

Jumbo Plastic Hy-Glo Signs

- Weather-resistant
- Durable
- Bright, attention-getting colors



SP-100



SP-101



SP-102



SP-103



SP-104



SP-105



SP-106



SP-107



SP-108



SP-110



SP-111



SP-112



SP-113 (two-sided)

SP-113 (two-sided sign)
 SIZE: 14 1/2" X 18 1/2"
 PACK: 5 Each



SP-114



SP-115



SP-117

SIZE: 14 1/2" X 18 1/2"
 PACK: 5 Each

Jumbo Plastic Signs

- Weather-resistant
- Durable
- Bright, attention-getting colors

SIZE: 15" X 19"
 PACK: 5 Each



20702



20703



20705



20707 (two sided)

20707 (two-sided sign)
 SIZE: 15" X 19"
 PACK: 5 Each

Plastic Recreational Sign

- Weather-resistant
- Highly visible
- Can be mounted on a stake or on a boat

SIZE: 10" X 14"
 PACK: 10 Each

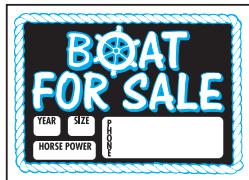

REC-1

Heavy-Duty Plastic Signs

- Weather-resistant
- Durable
- Bright & highly visible



YP-1



YP-2



YP-3



YP-5



YP-6



YP-7



YP-10



YP-12

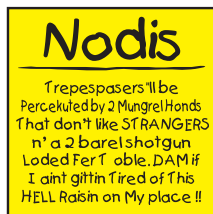

YP-16



YP-17



CFS-7



CFS-8

SIZE: 11" x 11"
PACK: 20 Each

Plastic Posted Sign Kit

- Weather-resistant
- Durable
- Bright & highly visible

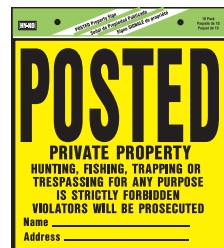

YP-1VP

CONTENTS: 10 Each Plastic
11" x 11" "POSTED" Signs Per Kit
PACK SIZE: 11" x 12.5"
PACK: 1

Plastic Hy-Glo Sign

- Weather-resistant
- Durable
- Bright, attention-getting colors



22650H

SIZE: 12.75" x 13"
PACK: 5

Plastic Fence Signs

- Weather-resistant
- Durable
- Bright & highly visible

SIZE: 6" X 14"
PACK: 5 Each



23001



23002



23003



23004



23005



23006



23007



23008



23009

Tyvek® Posted Sign Roll

- Weather- & tear-resistant
- Bright colors for high visibility
- 100 perforated signs per roll
- Display racks available:
RW-2GTSR 1-pocket basket

SIZE: 11" X 11" signs on 3" Roll
PACK: 1 Each



TSR-100

Tyvek Posted Sign Kit

- Weather- & tear-resistant
- Bright colors for high visibility
- Easily mount to trees, fences, poles, etc.



PP-1
CONTENTS: 10 Each
Tyvek 11" X 11" "POSTED" signs per kit
PACK SIZE: 14.50" X 12.25"
PACK: 1 Each

Corrugated Plastic Lawn Signs

- Weather-resistant
- Double-sided, bold lettering maximizes visibility
- Individually polybagged with one 23" (H) steel mounting bracket
- Mounting bracket inserts easily between corrugated openings

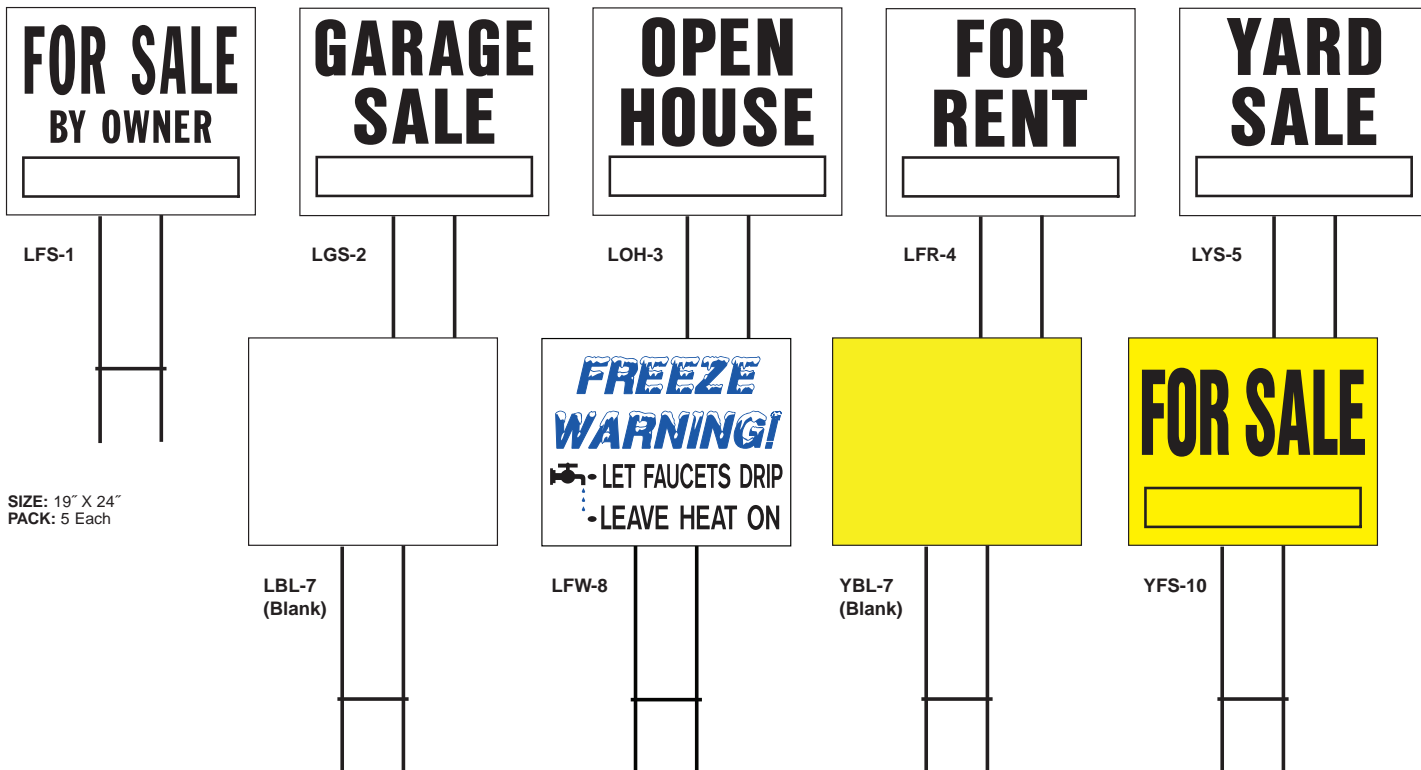

Extra Heavy-Duty Plastic Real Estate Signs

- Made of commercial-grade plastic
- Double-sided
- Can be mounted in heavy-gauge wire frame

SIZE: 20" x 24"
PACK: 5 Each



Corrugated Plastic Lawn Signs

- Weather-resistant
- Double-sided
- (H) steel mounting bracket included
- Mounting bracket easily inserts between the corrugated openings

SIZE: 6.75" x 24"
 PACK: 5 Each

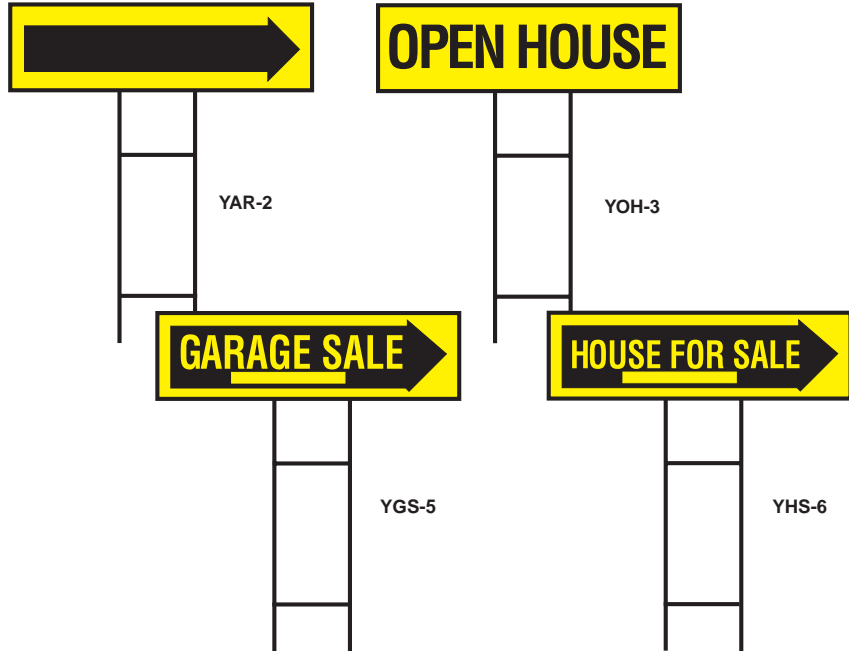

Large Corrugated Plastic Lawn Signs

- Weather-resistant
- Double-sided
- Individually packaged in polybag with one 24" (H) steel mounting bracket
- Mounting bracket easily inserts between the corrugated openings

SIZE: 9.5" x 24"
 PACK: 5 Each



Plastic Real Estate Signs with Frames

- Weather-resistant
- Double-sided, bold lettering maximizes visibility
- Sign comes attached to frame; no installation necessary



RSF-601



RSF-603



RSF-604



RSF-605



***Take One Tube and Take One Box
information dispensers available***

See page 39!

SIZE: 24.5" X 36.5"
PACK: 5 Each

Plastic Real Estate Signs

- Weather-resistant
- Double-sided, bold lettering maximizes visibility
- Sign can easily install on one of several metal frame or stake options (See Sign Frames & Stakes)



RS-601



RS-603



RS-604



RS-605



RS-607

SIZE: 18" X 24"
PACK: 5 Each

Sign Frames

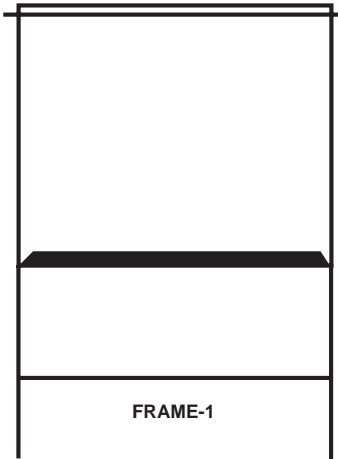

FRAME-1

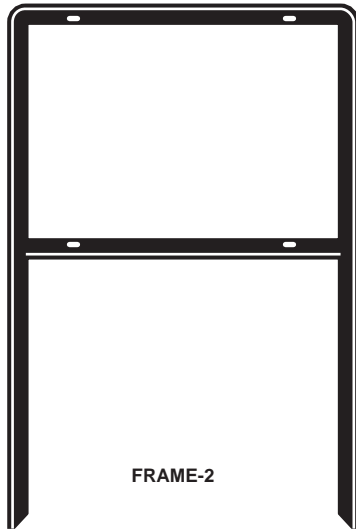

FRAME-2

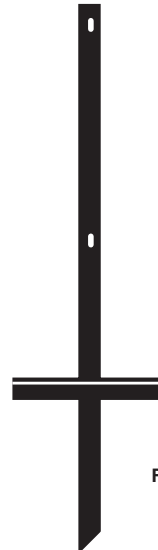

FRAME-3

Heavy-Duty Metal Sign Frame

FRAME-1
SIZE: 25.5" x 40"
PACK: 5 Each
WEIGHT: 12.48 Lbs.

Heavy-Duty Metal Sign Frame

FRAME-2
SIZE: 25.5" x 41.5"
PACK: 5 Each
WEIGHT: 33.48 Lbs.

Heavy-Duty Metal Stake

FRAME-3
SIZE: 8.5" x 42"
PACK: 5 Each
WEIGHT: 18.10 Lbs.

Accessories Sign Frames, Stakes & Information Dispensers

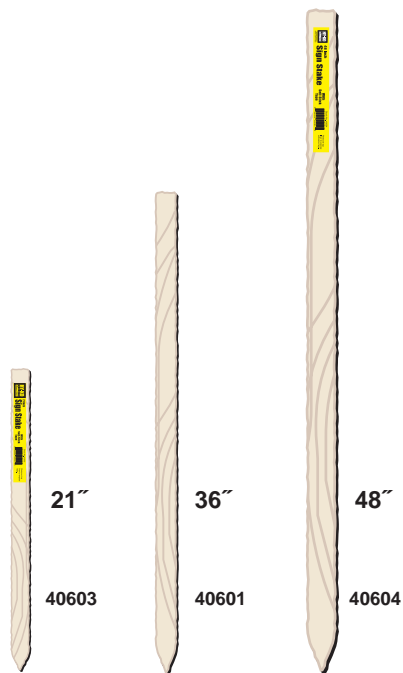

Wooden Sign Stakes

40603 SIZE: 21" PACK: 12 Each WEIGHT: 1.40 Lbs.	40601 SIZE: 36" PACK: 50 Each WEIGHT: 24 Lbs.	40604 SIZE: 48" PACK: 24 Each WEIGHT: 24 Lbs.
---	---	---



Take One Tube

- Holds informational flyers
- Attaches to most real estate signs
- Includes clip and cable ties

22130
SIZE: 3" x 12"
PACK: 6 Each
WEIGHT: 3.25 Lbs.



Take One Box

- Holds informational flyers
- Attaches to most real estate signs
- Includes cable ties

22131
SIZE: 3.5" x 10"
PACK: 3
WEIGHT: .60 Lbs.

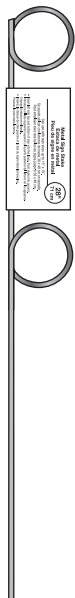

28" Metal Pigtail Sign Stake

- Holds standard plastic signs
- Can use with sign sizes up to 15" x 19" (use 2 stakes for larger sign sizes)

40640
SIZE: 6" x 24"
PACK: 12
WEIGHT: 2.0 Lbs.



Wire H-Bracket Sign Frame

- Holds plastic corrugated signs (top prongs fit into sign fluting)
- Natural add-on sale with corrugated signs

40641
SIZE: 6" x 23"
PACK: 12
WEIGHT: 1.0 Lbs.

Aluminum Hy-Glo Signs

- Weather-resistant • Bright, bold colors for high visibility
- Prepunched mounting holes for easy installation • Rounded corners for finished look



801



802



804



805



806



807



811



812



813



833



834



838



845



848



820 (two-sided sign)
 SIZE: 9.25" X 14"
 PACK: 12 Each

SIZE: 9.25" x 14"
 PACK: 12 Each

Special All-Aluminum Signs

- Weather-resistant
- Durable
- Prepunched mounting holes for easy installation
- Rounded corners for finished look



SM-2



SS-2W



SS-5



SS-10L



SS-11



SS-30

SIZE: 9.25" x 14"
PACK: 12 Each



SS-50

Illinois, Kansas, Missouri, North Carolina, Texas
(Purple color sign can be used to designate property boundaries.)



Aluminum Princess Signs

- Brushed aluminum finish
- Self-adhesive strips for easy mounting
- Red background = Urgent signs



411



415



402



409



426



427



431



433



434



435



437



440



441



443



444



445



448

SIGN SIZE: 2" x 8"
 CARD SIZE: 2.13" x 8.50"
 PACK: 10 Each

Self-Adhesive Vinyl Graphic Signs

- Silver background
- Self-adhesive
- Attaches to most surfaces



470



471



472



473

SIGN SIZE: 2" x 8"
 CARD SIZE: 2.13" x 8.50"
 PACK: 10 Each

Heavy-Duty Plastic Deco Designer Graphic Signs

- Polished white finish
- Self-adhesive strips for easy mounting
- Use in offices, factories, restaurants, hospitals, hotels, etc.

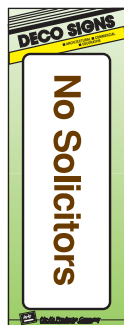

D-0

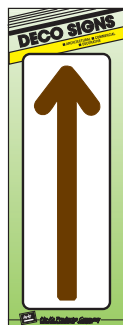

D-1



D-2

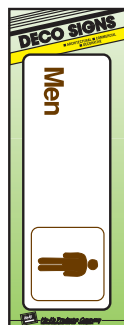

D-4



D-15



D-16



D-17



D-5



D-6



D-7



D-8



D-19



D-20



D-21

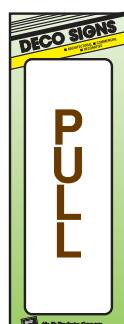

D-9

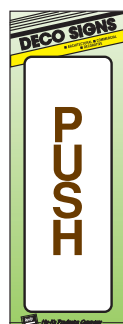

D-10

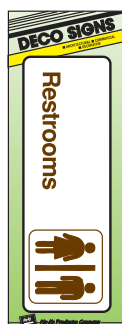

D-11

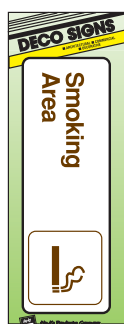

D-12



D-22



D-23

SIGN SIZE: 5" x 7"
CARD SIZE: 6" x 10"
PACK: 5 Each

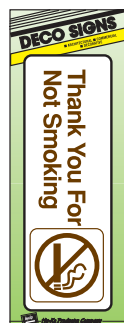

D-13

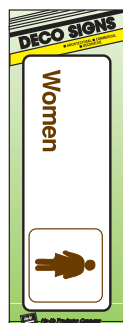

D-14

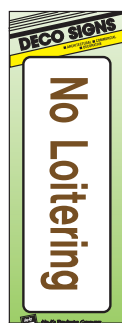

D-40

SIGN SIZE: 3" x 9"
CARD SIZE: 4" x 11"
PACK: 5 Each

Vinyl Graphic Signs

- Weather-resistant
- Durable
- Bright & highly visible

SIZE: 6.75" x 11"
PACK: 10 Each



HSV-8



HSV-17*



HSV-101*



HSV-102*

SIZE: 4" x 5"
PACK: 10 Each

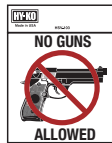

HSV-103

Heavy Duty Plastic Braille/Tactile Designer Graphic Signs

- Meets ADA (Americans with Disabilities Act) requirements
- Grade 2 Braille raised-lettering & graphics
- Self-adhesive strips for easy mounting

Braille/Tactile Signs



DB-1



DB-2



DB-3



DB-4



DB-5



DB-6



DB-7



DB-8



DB-17

Large Braille/Tactile Signs



DB-18

SIGN SIZE: 8" x 11"
CARD SIZE: 9" x 14.25"
PACK: 3 Each



DB-19

SIGN SIZE: 6" x 9"
CARD SIZE: 7" x 11.75"
PACK: 3 Each

ADA/Title 24 Plastic Signs

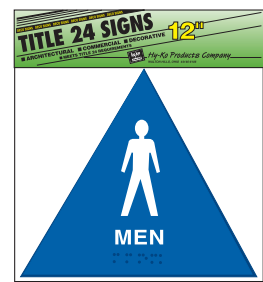

T-24M



T-24U

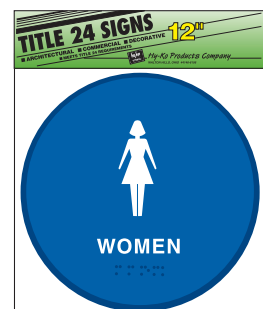

T-24W

SIGN SIZE: 12" x 12"
CARD SIZE: 13" x 15.75"
PACK: 3 Each

Vinyl Hy-Glo Static Cling Signs

- Printed on durable clear static-cling vinyl
- Held in place by static electricity
- Applied to inside window surface
- Easily removable

SIGN SIZE: 8" X 12"
PANEL SIZE: 9" X 12"
PACK: 10 Each

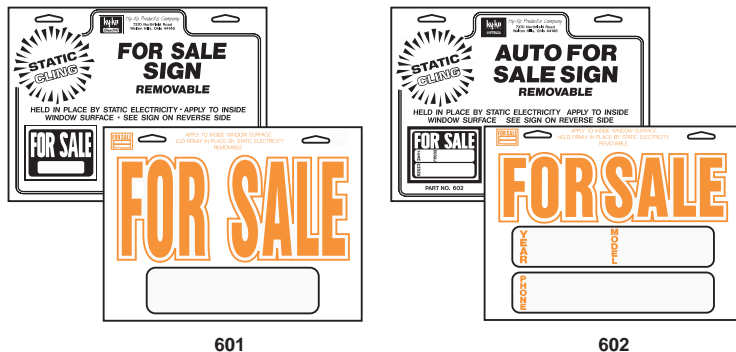

601

602

Large Garage Sale Sign Kit

- Packaged in a colorful poly bag
- Comes complete with all items needed for a successful garage sale

CONTENTS:
 4 Each 14" x 19" signs
 4 Each self-adhesive directional arrows
 4 Each bulletin board/table top display notices
 120 Each self-adhesive price labels
 5 Each price tags with strings
 1 Each inventory/sales record and helpful hints form
SIZE: 15" x 20.5"
PACK: 10 Each



KIT-2

Plastic Garage Sale Sign Kit

- Packaged in a colorful poly bag
- Comes complete with all items needed for a successful garage sale

CONTENTS:
 4 Each 9" x 12" Hy-Glo pink signs
 3 Each 4 1/2" x 12" directional arrows
 240 Each self-adhesive price labels
 1 Each inventory/sales record and helpful hints form
SIZE: 12.25" x 12.75"
PACK: 10 Each



KIT-13

A selection of price label packages are also available!
See page 55!

Garage Sale Sign Kit

- Packaged in a colorful poly bag
- Comes complete with all items needed for a successful garage sale

CONTENTS:
 4 Each 9" x 12" signs
 4 Each 4" x 12" directional arrows
 2 Sheets Each of 2" Adhesive Numbers
 300 Each self-adhesive price labels
 10 Each price tags with strings
 1 Each Black Marker
 1 Each inventory/sales record and helpful hints form
SIZE: 10" x 13"
SIGN SIZE: 9" x 12"
PACK: 3 Each

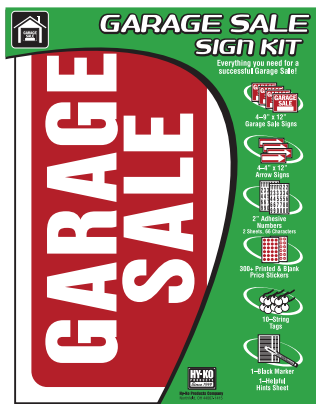

KIT-14

Auto For Sale Sign Kit

- Packaged in a colorful poly bag
- Comes complete with all items needed for a successful automobile sale

CONTENTS:
 4 Each 9" x 12" signs
 4 Each 4" x 12" directional arrows
 2 Sheets Each of 2" Adhesive Numbers
 300 Each self-adhesive price labels
 10 Each price tags with strings
 1 Each Black Marker
 1 Each inventory/sales record and helpful hints form
SIZE: 10" x 13"
SIGN SIZE: 9" x 12"
PACK: 3 Each

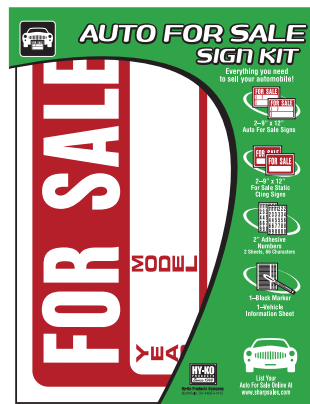

KIT-15

Spanish Bilingual Plastic Hy-Glo Signs

- Weather-resistant
- Durable
- Bright & highly visible colors
- Shows both Spanish and English sign wordings



3060



3061



3062



3064



3065



3066



3067



3058



3069



3070



3071



3072



3073



3074 (two-sided)



3075

SIZE: 9" x 12"
PACK: 10 Each

3074 (two-sided sign)
SIZE: 9" x 12"
PACK: 10 Each

Spanish Bilingual Aluminum Sign

- Weather-resistant
- Pre-punched mounting holes & rounded corners
- Shows both Spanish and English sign wordings



CFS-1



SS-50

SIZE: 9.25" X 14"
PACK: 12 Each

Illinois, Kansas, Missouri, North Carolina, Texas
(Purple color sign can be used to designate property boundaries.)

Spanish Bilingual Jumbo Plastic Sign

- Weather-resistant
- Durable
- Bright & highly visible colors



SP-230

SIZE: 15" x 19"
PACK: 5 Each

Spanish Bilingual Jumbo Plastic Sign

- Weather-resistant
- Bright, bold colors for high visibility
- Shows both Spanish and English sign wordings

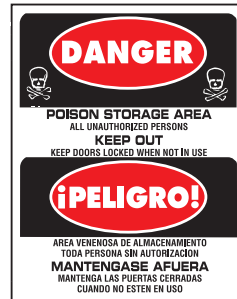

CFS-5

SIZE: 15" x 19"
PACK: 5 Each

Numbers, Letters & Signs

...also available in Spanish

In addition to bilingual signs, Hy-Ko stocks a wide assortment of product for Latin America. We supply product to more than 75% of the countries, which means we understand the complexities of business throughout the region, including the sensitivities of currency fluctuation, intermodal transportation, insurance, customs, tariffs and taxes.

Hy-Ko can assist you with language-specific products, packaging, point-of-sale material, merchandising displays, promotional programs and catalogs. Ask for our Spanish catalog to learn more about these exciting opportunities.



Números, Letras y Letreros

...también los tenemos en español

Además de letreros bilingües, Hy-Ko tiene un amplio surtido de productos para Latinoamérica. Nosotros proporcionamos productos a más del 75% de esos países, lo que significa que comprendemos las complejidades de hacer negocios en la región, incluyendo cómo la afecta los cambios de cotización de divisas, el transporte multimodal, seguros, aduanas, tarifas y aranceles.

Hy-Ko puede servirlo con productos en su idioma específico, empaque, materiales para el punto de venta, carteles de venta, programas promocionales y catálogos. Solicite nuestro nuevo catálogo en español para averiguar más sobre estas nuevas e interesantes oportunidades.

Sell-It-Yourself Signs, Pennant Flags, Patriotic Decals & Markers



**Choose from our new selection
of signs and related products including:**

*Houses, cars, bicycles, mowers, furniture,
clothing – you name it, more and more
owners are selling it themselves! You can
expand your sales by helping your customers
attract more buyers with Hy-Ko's
Sell-It-Yourself Signs!*

*Choose from a variety of colorful,
contemporary, eye-catching designs –
all printed on durable, weather-resistant
materials.*

*You can now offer your customers the
opportunity to add an internet listing of
their items for sale...increasing exposure
to potential buyers!*



Sell-It-Yourself Signs
With Internet Listing Option
50-52



Multicolor Plastic Signs
53-54



Pennant Flags
54

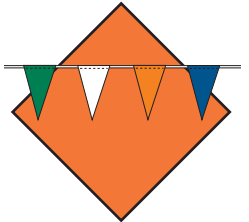

Price Labels
55



Window &
Permanent Markers
55



Sell-It-Yourself Sign Program

This selection of colorful signs are designed to be used in combination with an internet listing.

This 21st century solution to helping sell homes, cars and stuff using both signs and the Internet... gives your customers the ability to advertise 24/7 to a larger audience of potential buyers.

12" x 13" Corrugated Plastic Post Signs

- Brightly colored
- Bold lettering maximizes visibility
- Internet-ready to help your customers sell their homes, cars, and stuff!

SIZE: 12" x 13"
PACK: 3



SSP-101



SSP-102



SSP-103



SSP-104

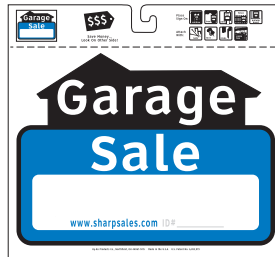

SSP-105

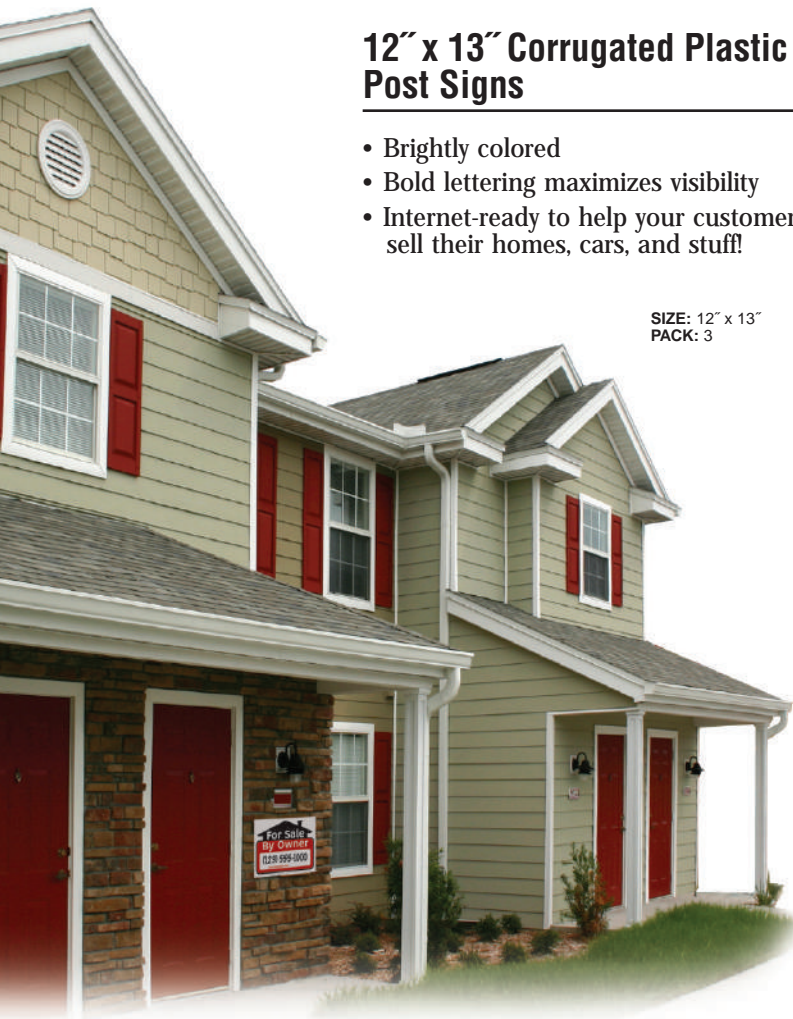

10" x 15" Corrugated Plastic Sign

- Brightly colored
- Double-sided, bold lettering maximizes visibility
- Internet-ready to help your customers sell their homes, cars & stuff!

SIZE: 10" x 15"
PACK: 3



SSP-152

Plastic Corrugated Directional Signs

- Brightly colored
- Double-sided, bold lettering maximizes visibility
- Internet-ready to help your customers sell their homes, cars & stuff!

PRODUCT SIZE: 9.5" x 24"
SIGN SIZE: 9.5" x 22"
PACK: 3



SSP-201

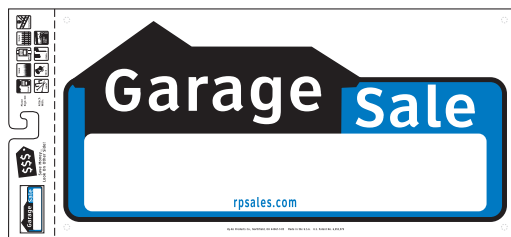

SSP-202



SSP-203



SSP-204



SSP-301



SSP-302



SSP-303



SSP-304

Corrugated Plastic Lawn Signs

- Brightly colored
- Double-sided, bold lettering maximizes visibility
- Internet-ready to help your customers sell their homes, cars & stuff!

PRODUCT SIZE: 20" x 24"
SIGN SIZE: 19" x 24"
PACK: 3

14" x 20" Corrugated Plastic Real Estate Signs & Frames

- Brightly colored
- Double-sided, bold lettering maximizes visibility
- Durable 42" high metal frame
- Internet-ready to help your customers sell their homes, cars & stuff!

SIZE: 14" x 20"
 PACK: 3
 WEIGHT: 9.00 Lbs.



SSP-401

SSP-402

SSP-403

SSP-404

SharpHome.com Signs

Value-priced to drive sign sales!



POS-24SH
 24-Sign
 Pallet Display

19" x 24" Heavy-Duty Corrugated Sign with Frame

- 59" Tall sign with frame designed to attract attention
- Weather-resistant, Take One Bag with magnetic closure securely attaches to sign
- Lets customers list homes on SharpHome.com to reach more buyers
- Optional removable labels

SIGN SIZE: 19" x 24"
 SIZE WITH FRAME: 19" x 58.25"
 PACK: 3
 WEIGHT: 10.00 Lbs.



LFS-301



14" x 18" Plastic Real Estate Sign with Frame

- Double-sided, bold lettering maximizes visibility
- Durable 42" high metal frame
- Optional sharpsales.com placard can be hung from sign, allowing the customer to provide information on the website to gain additional selling exposure.

SIZE: 14" x 18" sign with frame
 PACK: 3
 WEIGHT: 9.25 Lbs.



SIY-201

9" x 14" Multicolor Plastic Signs

- Bright and colorful designs
- Weather-resistant
- Can be easily mounted to stakes for outdoor use



22102



22103



22104



22106

SIZE: 9" x 14"
PACK: 10 Each
WEIGHT: 1.08 Lbs.

12³/₄" x 13" Multicolor Plastic Signs

- Offer your customers a variety of fun and colorful designs
- Weather-resistant styrene
- Can be easily mounted on stakes for outdoor use



22601



22602



22606



22607



22608



22610



22616

SIZE: 12.75" x 13"
PACK: 5 Each
WEIGHT: 1.40 Lbs.

13" x 13" Licensed Character Sell-It-Yourself Signs

- Popular characters in bright, colorful designs
- Weather-resistant
- Can be easily mounted to stakes for outdoor use



22902



22903



22912



22913

SIZE: 13" x 13"
PACK: 5 Each
WEIGHT: .81 Lbs.

50 Ft. Multicolored Polyethylene Pennant Flags

- 11" x 18.5" V-shaped pennants
- 22 pennants total 50 ft.
- Contains 6 colors (red, white, blue, yellow, green & orange)
- Weather-resistant & durable poly plastic material
- Use for special events, such as grand openings, parties, sporting events, sales promotions, store identification, garage sales, and open houses, etc.

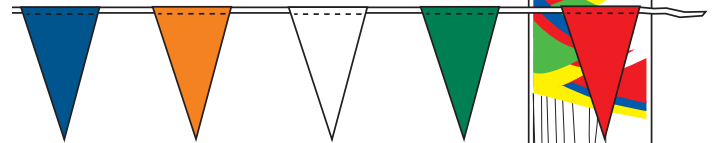

PEN-2
SIZE: 3.5" x 22"
PACK: 10 Each
WEIGHT: .54 Lbs.

PEN-3
Polybagged pennant flags
SIZE: 3.5" x 20.5"
PACK: 10 Each
WEIGHT: .54 Lbs.



Decorative Flag Decals

- Self-adhesive vinyl
- Adheres to any clean, dry surface
- Can be placed on windows, car bumper, mailboxes, etc.



KIT-6
PANEL SIZE: 7" x 4"
DECAL SIZE: 2" X 3.5"
PACK: 10 Panels
WEIGHT: .10 Lbs.

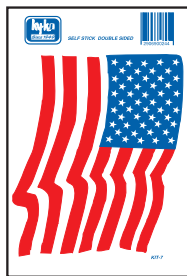

KIT-7
PANEL SIZE: 5" x 7"
DECAL SIZE: 4.25" x 5.5"
PACK: 10 Panels
WEIGHT: .10 Lbs.

Adhesive Price Labels

- Neon green, pink or yellow colors to choose from
- Over 300 assorted, self-adhesive price labels per package
- An easy way to mark merchandise at any sales event (garage sale, yard sale, bake sale, etc.)

CARD SIZE: 5 1/4" x 9"
PACK: 10 Each
WEIGHT: 1.34 Lbs.

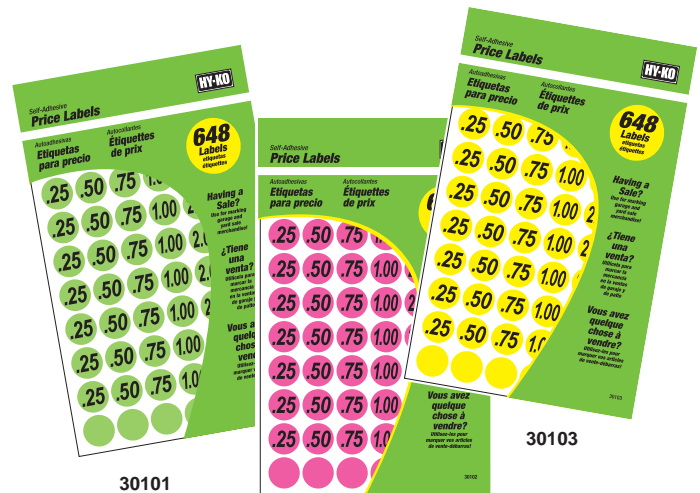

30101

30102

30103

Permanent Sign Markers

- Fast-drying, non-fading black ink
- Marks most surfaces
- Great for home, school, office, & industrial use

CARD SIZE: 3" x 7 1/4"
 PACK: 5 Each
 WEIGHT: .31 Lbs.

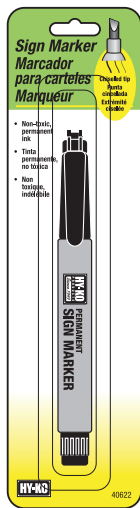

40622

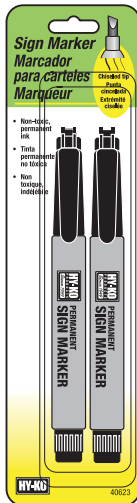

40623

Window Markers

- Non-Toxic, removable paint
- White, yellow, blue, or fluorescent-orange colors to choose from
- Aneasy way to mark any glass surface
- 48ml/ 2.05 oz each

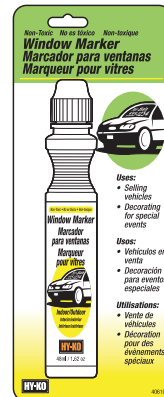

40610 (White)

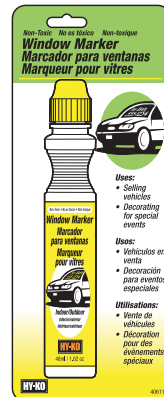

40611 (Yellow)

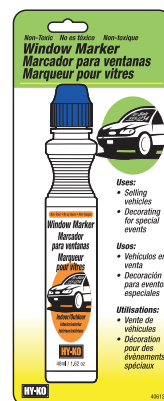

40612 (Blue)

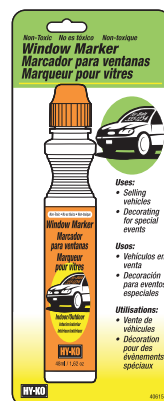

40615 (Orange)

CARD SIZE: 3" x 7 1/2"
 PACK: 3 Each
 WEIGHT: .56 Lbs.

Window Markers

- Non-Toxic, removable paint
- Easy to remove with wet cloth
- 12ml/ 0.4 oz each
- 2 pack

NEON! NEON!

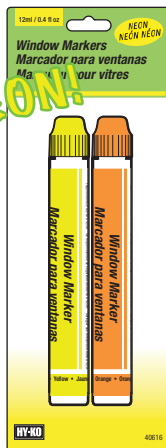

40616 (Yellow/Orange)



40617 (Pink/Green)



CARD SIZE: 3" x 7 1/2"
 PACK: 3 Each
 WEIGHT: .56 Lbs.



40613 (Blue/White/Red/Yellow)

- Non-Toxic, removable paint
- Easy to remove with wet cloth
- 12ml/ 0.4 oz each
- 4 pack.

Traffic & Safety Products



Choose from our extensive selection of traffic & safety products including:

Parking lots can be the scenes of accidents if not properly marked. So, too, can building interiors when utility services are interrupted or when maintenance is being performed. Activities or products stored within buildings can also cause bodily harm.

Help owners and managers of residential and commercial structures guard against mishaps and possible legal claims with Hy-Ko's traffic and safety-promoting signs. Included are those required by OSHA as well as Emergency Notification signs to conform to building codes.

Traffic & Parking Signs
58-60



Slow Moving Vehicle
Emblems
60

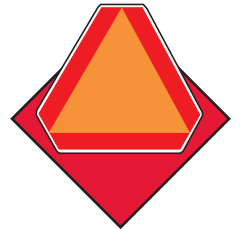

Emergency Notification
& OSHA Signs
61-62



Safety & Surveying
Tape Rolls,
Safety Cones & Flags
63-64



Floor Stands &
Parking Lot Stencils
64-65

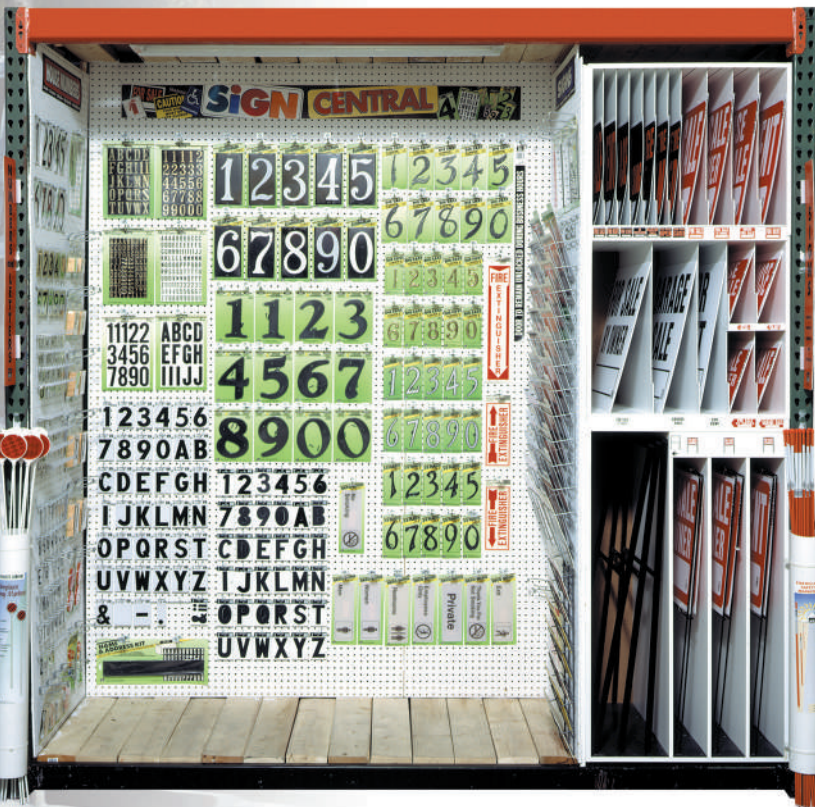

Hy-Ko's bay displays are tailored for warehouse-format stores. The warehouse-style racking can hold varying amounts of stock quantities that can easily and quickly be refilled. Custom planogramming is available.

12" x 18" Heavy-Duty Aluminum Traffic Signs

- Bright, bold colors for maximum visibility
- Extremely durable
- Pre-punched mounting holes
- Individually packaged



HW-1



HW-4



HW-6



HW-7



HW-9



HW-10



HW-13



HW-23



HW-24



HW-26



HW-27



HW-28



HW-29



HW-32



HW-34



HW-37



HW-38



HW-42



HW-43

SIZE: 12" x 18"
PACK: 1 Each
WEIGHT: .62 Lbs.

12" x 18" Heavy-Duty Aluminum Traffic Signs (continued)



HW-44



HW-45



HW-47



HW-48

SIZE: 12" x 9"
PACK: 1 Each
WEIGHT: .40 Lbs.



HW-49



HW-61 (Ohio)

SIZE: 12" x 18"
PACK: 1 Each
WEIGHT: .62 Lbs.



HW-31

SIZE: 18" X 18"
PACK: 1 Each
WEIGHT: 1.1 Lbs.



HW-65

SIZE: 24" x 24"
PACK: 1 Each
WEIGHT: 2.82 Lbs.



HW-62

SIZE: 16" x 16"
PACK: 1 Each
WEIGHT: 1.01 Lbs.



HW-22

SIZE: 12" x 12"
PACK: 1 Each
WEIGHT: .45 Lbs.



For full product selection
please request our
**Commercial & Industrial
Sign Brochure**

15" x 19" Heavy-Duty Plastic Parking Signs

- Commercial grade plastic
- Meets many local requirements
- Individually packaged



700



701



702



703

12" x 6" Reflective Aluminum Signs

- Weather-resistant
- Durable
- Individually packaged



HW-54

SIZE: 12" x 6"
PACK: 1 Each
WEIGHT: .40 Lbs.

9" x 9" Aluminum Truss Signs

- Meets Florida Safety Code 69A-60.0081 Specifications for use in light-frame truss-type construction
- Reflective red symbol
- Individually packaged



HW-67 (FLORIDA)



HW-68 (FLORIDA)



HW-69 (FLORIDA)

SIZE: 15" X 19"
PACK: 1 Each
WEIGHT: .13 Lbs

SIZE: 9" x 9"
PACK: 1 Each
WEIGHT: .33 Lbs

Aluminum/Vinyl Slow Moving Vehicle Emblems



TA-1
Aluminum Emblem
SIZE: 16" x 14"
PACK: 12 Each
WEIGHT: 7.72 Lbs.



VB-2
Blade Support for TA-1 Emblem
SIZE: 2.50" x 11"
PACK: 12 Each
WEIGHT: 5.46 Lbs.

TD-2
Vinyl Emblem Decal
SIZE: 13.75" x 15.75"
PACK: 12 Each
WEIGHT: 1.36 Lbs.



VS-3
Mounting Socket for TA-1 Emblem
SIZE: 4" x 8"
PACK: 12 Each
WEIGHT: 2.42 Lbs.

High Visibility Slow Moving Vehicle Emblems

- Meets American Society of Agricultural Engineers S276.5 Certified SMV Emblem Specifications



TA-5
Aluminum Emblem
SIZE: 16" x 14"
PACK: 12 Each
WEIGHT: 7.72 Lbs.

TD-5
Vinyl Emblem Decal
SIZE: 13.75" x 15.75"
PACK: 12 Each
WEIGHT: 1.36 Lbs.

10" x 14" Heavy-Duty Polyethylene OSHA Signs

- Durable
- Weather-resistant
- Use in industrial workplace settings
- Choose any of these wordings: "DANGER", "CAUTION", "NOTICE", "WARNING" and "SAFETY FIRST"



501



507



508



509



512



514



515



520



523

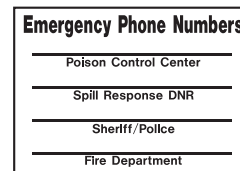

527



532



535



540



541



550



557



559



562



566



567



570



572



573



580



581



582



590



591



592

SIZE: 10" x 14"
 PACK: 5 Each
 WEIGHT: 1.32 Lbs.

Vinyl Glow-In-The-Dark Safety Signs

- Glows in total darkness after exposure to a light source
- Self-adhesive



EE-2

PANEL SIZE: 8" x 11"
 SIZE: 8" x 10" with 6" Letters
 PACK: 10 Each
 WEIGHT: .64 Lbs.



EE-3

PANEL SIZE: 11" x 12"
 SIZE: 10" x 12" with 8" Letters
 PACK: 10 Each
 WEIGHT: 0.99 Lbs.



FA-1

PANEL SIZE: 4" x 11"
 SIZE: 4" x 10"
 PACK: 10 Each
 WEIGHT: .42 Lbs.



FE-2R



FE-2L

PANEL SIZE: 4" x 11"
 SIZE: 4" x 10"
 PACK: 10 Each
 WEIGHT: .33 Lbs.



FE-1

PANEL SIZE: 4" x 19"
 SIZE: 4" x 18"
 PACK: 10 Each
 WEIGHT: .55 Lbs.



FH-1

PANEL SIZE: 4" x 19"
 SIZE: 4" x 18"
 PACK: 10 Each
 WEIGHT: .55 Lbs.

High-Grade Photoluminescent Safety Signs

- Meets ASTM E 2072 (American Society for Testing and Materials) Standards for safety markings
- Absorbs and stores ambient light
- Self-adhesive vinyl



EE-12XPL

PANEL SIZE: 8" x 11"
 SIZE: 8" x 10" with 6" Letters
 PACK: 10 Each
 WEIGHT: .64 Lbs.



EE-14XPL

PANEL SIZE: 11" x 14"
 SIZE: 10" x 14"
 PACK: 10 Each
 WEIGHT: .99 Lbs.



EE-15XPL

PANEL SIZE: 5" x 7"
 SIZE: 6" x 7"
 PACK: 10 Each
 WEIGHT: .33 Lbs.



FE-10XPL

PANEL SIZE: 4" x 19"
 SIZE: 4" x 18"
 PACK: 10 Each
 WEIGHT: .55 Lbs.

9" x 12" Lead Warning Signs

- Weather-resistant plastic
- Durable
- Used to protect public and private safety

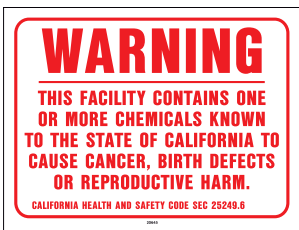

20645
 (Prop 65 California)



20646
 (California)



20647

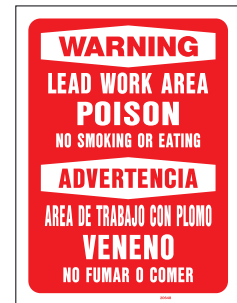

20648

SIZE: 9" x 12"
 PACK: 10
 WEIGHT: .62 Lbs.

Vinyl Safety/Boundary Stake Flags

- Choose from a variety of day-glo colors
- High-visibility
- Marks underground pipes/wires/cables
- Reusable

SF-21 Series
Pack of 25 Each

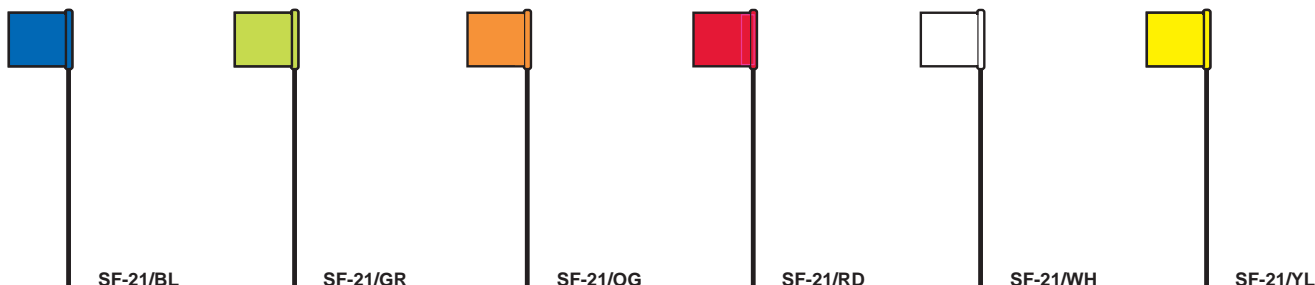

HEIGHT: 21"
BUNDLE SIZE: 1.50" x 21"
PACK: 25 Each
SIZE: 1.5" x 21"
WEIGHT: 0.5 Lbs.

2" x 24" Reflective Vinyl Safety Tapes

- Self-adhesive
- Weather resistant
- Used to mark items for easy visibility (commercial vehicle, fire extinguisher, mailbox, stairway)



CARD SIZE: 3.75" x 7"
TAPE SIZE: 2" x 24"
PACK: 5 Each
WEIGHT: .30 Lbs.

2" x 8" Vinyl Self-Adhesive Fuel Safety Signs

- Self-stick labels
- Used to identify fuel containers for safety purposes
- Attaches to most surfaces



SIZE: 2" x 9.5"
PACK: 10 each
WEIGHT: .080 Lbs.

Poly Safety Tape Rolls

- Brightly visible
- Inexpensive
- Reusable
- For residential / commercial use



CAR-300



CAR-305



CAR-301

TAPE SIZE: 3" x 300'
 ROLL SIZE: 3" x 3"
 PACK: 6 Each
 WEIGHT: 6.04 Lbs.

20" Corrugated Plastic Safety Floor Stand

- Double-sided stand
- Heavy-duty corrugated plastic
- Directs attention to hazardous areas



PFS-11

HEIGHT: 20"
 SIZE: 20.25" x 12.25"
 PACK: 5 Each
 WEIGHT: 4.26 Lbs.

Self-Adhesive Vinyl Industrial Sign

- For commercial/industrial use
- Bold type for high visibility

THIS DOOR TO REMAIN UNLOCKED WHILE BUILDING IS OCCUPIED



CV-2

SIZE: 1.50" x 28"
 PANEL SIZE: 1.50" x 30.5"
 PACK: 10 Each
 WEIGHT: .02 Lbs.

12", 18", 28" & 36" Triangular Day-Glo Vinyl Traffic Safety Cones

- Flexible, yet durable
- Bright color for high visibility
- Choose from four different sizes

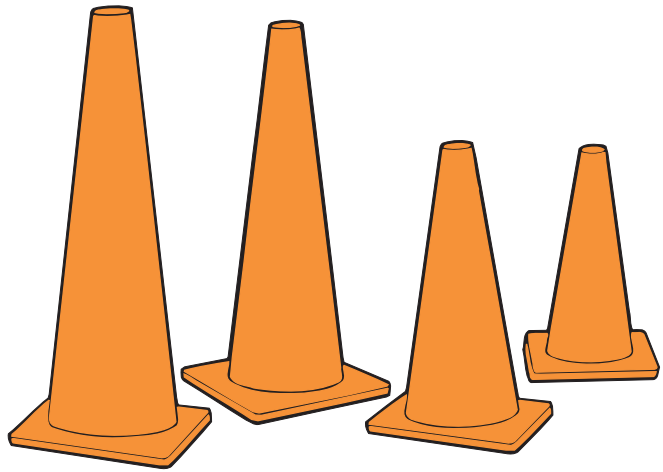

SC-36

HEIGHT: 36"
 SIZE: 36" x 15.5"
 PACK: 3 Each
 WEIGHT: 34 Lbs.

SC-28

HEIGHT: 28"
 SIZE: 28" x 13.13"
 PACK: 6 Each
 WEIGHT: 36.80 Lbs.

SC-18

HEIGHT: 18"
 SIZE: 18" x 11.25"
 PACK: 6 Each
 WEIGHT: 22.16 Lbs.

SC-12

HEIGHT: 12"
 SIZE: 12" x 9"
 PACK: 6 Each
 WEIGHT: 10.34 Lbs

32.5" x 25" Parking Lot Stencil

- Heavy-duty stencil board
- Water-resistant
- Reusable

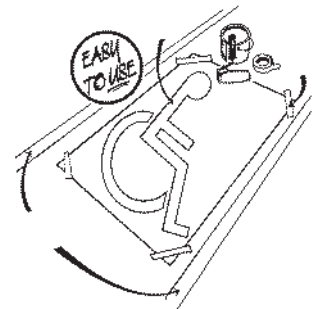

PLS-10

STENCIL SIZE: 37" x 29.25"
 SYMBOL SIZE: 32.5" x 25"
 SIZE: 20" x 16"
 PACK: 1 Each
 WEIGHT: 52 Lbs.

Heavy-Duty Plastic Parking Lot Stencils

- Easy to mark any parking lot surface
- Reusable
- 3" letters (PLS-51, PLS-52, PLS-54, PLS-55)



PLS-50



PLS-51



PLS-54



PLS-52



PLS-55

STENCIL SIZE: 5" x 24"
 SIZE: 3" lettering
 PACK: 5 Each
 WEIGHT: 1.5 Lbs.

STENCIL SIZE: 24.5" x 24.5"
 SIZE: 18" image area
 PACK: 5 Each
 WEIGHT: 5.6 Lbs.

Large Parking Lot Stencils

- Heavy-duty plastic
- 12" letters (excluding PLS-67)



PLS-61



PLS-62



PLS-64



PLS-65



PLS-66

STENCIL SIZE: Varies
 SIZE: 12" lettering (excluding PLS-67)
 PACK: 1 Each
 WEIGHT: 2.0 Lbs.



PLS-67



PLS-60

STENCIL SIZE: 48" x 48"
 SIZE: 38.5" x 33.5" symbol size
 PACK: 1 Each
 WEIGHT: .50 Lbs.

Driveway/Safety Markers and Reflectors

Property owners want to protect their lawns and landscaping. Some may also need to identify their land boundaries. Still others may have to alert drivers and walkers of furrows and other frontage hazards.

Hy-Ko can help you help them by carrying our line of driveway/safety markers and reflectors. Available in an assortment of colors, both driveway markers and reflectors feature brilliant break-resistant Plexiglas that is highly visible at night and in bad weather.

Safety Marker/ Road Marker Programs

POS-288DM

SIZE: Multiple boxes, various sizes
PACK: 1 Each

CONTENTS

Hy-Ko Item No.	Description
DM80048	108 qty - 48" orange fiberglass markers
DM85048	108 qty - 48" yellow fiberglass markers
DM80048G	72 qty - 48" green fiberglass markers
RW-DM4B	1 black driveway marker floor display

Compact driveway/safety marker floor displays are ideal for high traffic areas.



POS-288DM

POS-96RM

SIZE: Multiple boxes, various sizes
PACK: 1 Each

CONTENTS

Hy-Ko Item No.	Description
DMD80048A	24 qty - 48" amber diamond road markers
DMD80048B	24 qty - 48" blue diamond road markers
DMD80048R	48 qty - 48" red diamond road markers
RW-DM4B	1 black driveway marker floor display



POS-96RM

36" & 48" Fiberglass-Reinforced Markers

- Molded head on flexible fiberglass-reinforced rod
- Brilliant break-resistant Plexiglas reflector
- Display on pegboard or display merchandiser

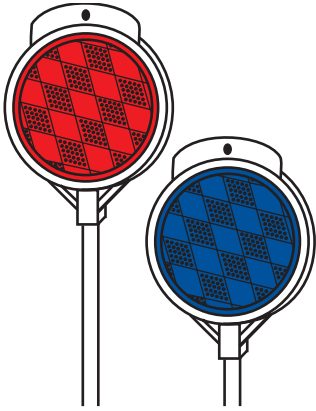

DM300R36 (Red)
DM300B36 (Blue)

HEIGHT: 36"
SIZE: 37" x 10.5"
PACK: 24 Each
WEIGHT: 6.10 Lbs.

DM300R48 (Red)
DM300B48 (Blue)

HEIGHT: 48"
SIZE: 48.75" x 10.5"
PACK: 24 Each
WEIGHT: 7.23 Lbs.

COLORS AVAILABLE: ● ●

36" & 48" Standard Aluminum Markers

- Molded head on twisted aircraft-grade aluminum rod
- Brilliant break-resistant plexiglas reflector
- Rustproof
- Display on pegboard or display merchandiser

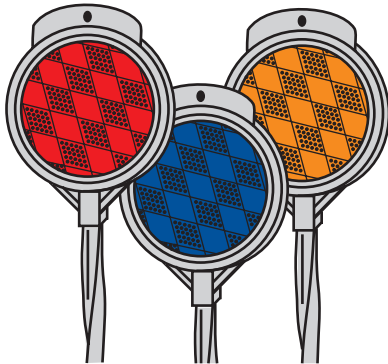

DM100R36 (Red)
DM100B36 (Blue)
DM100A36 (Amber)

HEIGHT: 36"
SIZE: 37" x 10.50"
PACK: 24 Each
WEIGHT: 6.50 Lbs.

DM100R48 (Red)
DM100B48 (Blue)
DM100A48 (Amber)

HEIGHT: 48"
SIZE: 48.75" x 10.50"
PACK: 24 Each
WEIGHT: 7.68 Lbs.

COLORS AVAILABLE: ● ● ●



Fiberglass-Reinforced Safety Markers

- Made of durable fiberglass-reinforced rods
- Reflective tape is wrapped around each marker
- Each is capped to make it easy to pound into the ground
- Visible from all angles

48" 48" 48" 54" 72"

Value Pack of 6

DM80048 (Orange)
DM80048G (Green)
 HEIGHT: 48"
 SIZE: 50" x 3"
 PACK: 36 Each
 WEIGHT: 9 Lbs.

DM85048 (Yellow)
 HEIGHT: 48"
 SIZE: 50" x 3"
 PACK: 36 Each
 WEIGHT: 9 Lbs.

DM800VP6 (Orange)
 HEIGHT: 48"
 SIZE: 50" x 3"
 PACK: 6 bundles of 6 each
 WEIGHT: 9 Lbs.

DM80054 (Orange)
 HEIGHT: 54"
 SIZE: 55" x 3"
 PACK: 12 Each
 WEIGHT: 3 Lbs.

DM80072 (Orange)
 HEIGHT: 72"
 SIZE: 74" x 3"
 PACK: 36 Each
 WEIGHT: 13 Lbs.

48" Road Markers

- High visibility retroreflective film on 6" diamond-shaped head
- Heavy-duty, powder-coated steel rod
- Designed for easy installation

DMD80048R (Red)
DMD80048B (Blue)
DMD80048A (Amber)
DMD80048S (Silver)

HEIGHT: 48"
 SIZE: 50" x 8.75"
 PACK: 12 Each
 WEIGHT: 12 Lbs.

COLORS AVAILABLE: ●●●●○

Heavy Duty Aluminum Markers

- Molded head on heavy-duty twisted aircraft-grade aluminum
- Brilliant break-resistant plexiglas reflector
- Rustproof
- Display merchandiser available

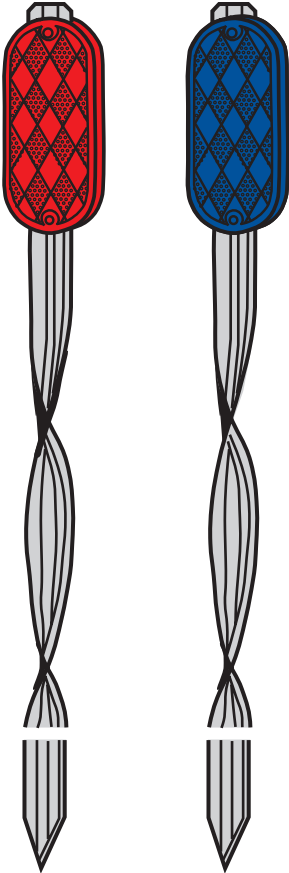

LM500R36 (Red)

HEIGHT: 36"
 SIZE: 37" x 8.75"
 PACK: 24 Each
 WEIGHT: 11.18 Lbs.

**LM500R48 (Red)
 LM500B48 (Blue)**

HEIGHT: 48"
 SIZE: 49" x 8.75"
 PACK: 24 Each
 WEIGHT: 14.26 Lbs.

COLORS AVAILABLE: ● ● ● ●

Carded Reflectors

- Made of break-resistant plexiglas
- Skin-packed on attractive cards
- Display on pegboard or display rack

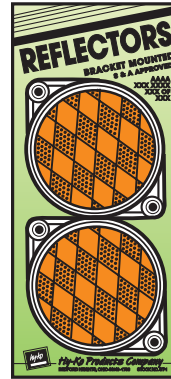

CDRF-3

Bracketed Nail-On Reflectors

**CDRF-3R (Red)
 CDRF-3B (Blue)
 CDRF-3A (Amber)
 CDRF-3C (Crystal)**
 CARD SIZE: 9.63" x 4.88"
 DIAMETER: 3/4"
 PACK: 12 Each
 WEIGHT: 1.64 Lbs.

COLORS AVAILABLE: ● ● ● ●

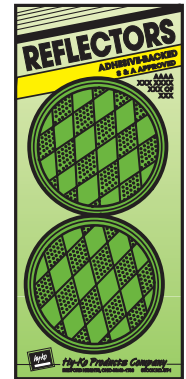

CDRF-4

Self-Adhesive Press-On Reflectors

**CDRF-4R (Red)
 CDRF-4B (Blue)
 CDRF-4A (Amber)
 CDRF-4G (Green)
 CDRF-4C (Crystal)**
 CARD SIZE: 9.63" x 4.88"
 DIAMETER: 3/4"
 PACK: 12 Each
 WEIGHT: 1.12 Lbs.

COLORS AVAILABLE: ● ● ● ● ●

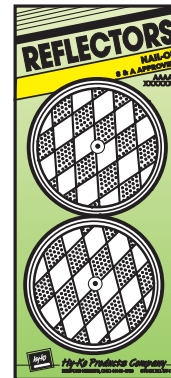

CDRF-5

Nail-On Reflectors

**CDRF-5R (Red)
 CDRF-5B (Blue)
 CDRF-5A (Amber)
 CDRF-5C (Crystal)**
 CARD SIZE: 9.63" x 4.88"
 DIAMETER: 3/4"
 PACK: 12 Each
 WEIGHT: 1.02 Lbs.

COLORS AVAILABLE: ● ● ● ●

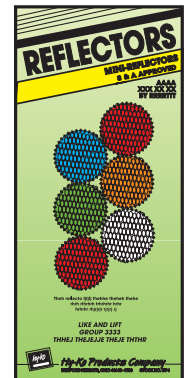

CMR-10

Self-adhesive Press-On Assorted Colors Only

CMR-10
 CARD SIZE: 9.63" x 4.88"
 DIAMETER: 1/4"
 PACK: 12 Each
 WEIGHT: .68 Lbs.

Carded Reflectors

- Made of break-resistant plexiglas
- Skin-packed on attractive cards
- Display on pegboard or display rack

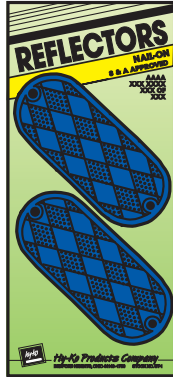

CORB-6

Nail-on Reflectors
CORB-6B (Blue)
 CARD SIZE: 9.63" x 4.88"
 DIAMETER: 4 3/8"
 PACK: 12 Each
 WEIGHT: 1.08 Lbs.

COLORS AVAILABLE: ●

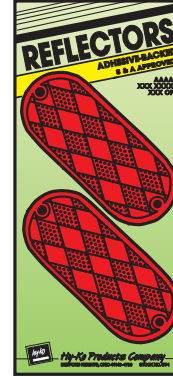

CORB-7

Self-adhesive Reflectors
CORB-7R (Red)
CORB-7B (Blue)
CORB-7A (Amber)
 CARD SIZE: 9.63" x 4.88"
 DIAMETER: 4 3/8"
 PACK: 12 Each
 WEIGHT: 1.12 Lbs.

COLORS AVAILABLE: ●●●

Bracketed Reflectors in Display Cartons

- Plexiglas reflectors are mounted in rugged, break-resistant molded plastic
- Attach with screws, nails or bolts

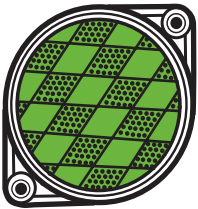

DRF-3R (Red)
DRF-3B (Blue)
DRF-3A (Amber)
DRF-3G (Green)
DRF-3C (Crystal)
 SIZE: 7.50" x 4.50"
 DIAMETER: 3 1/4"
 PACK: 24 Each
 WEIGHT: 1.48 Lbs.

COLORS AVAILABLE: ●●●●○

Nail-On Reflectors in Display Cartons

- Plexiglas reflectors attach with nails, bolts or screws



DRF-5B (Blue)
 SIZE: 7.50" x 4.50"
 DIAMETER: 3 1/4"
 PACK: 24 Each
 WEIGHT: .96 Lbs.

COLORS AVAILABLE: ●

Farm and Ranch Signs

Farms and ranches are picturesque settings for those who are unfamiliar with the dangers associated with machinery, livestock, pesticides and other chemicals.

But those who work in the business of agriculture or animal husbandry often need reminders of the hazards.

Do your customers a service by providing them with Hy-Ko's durable health and safety promoting signs to minimize risk and liability.



Aluminum/Vinyl Slow Moving Vehicle Emblems

- Choice of aluminum (TA-1) or adhesive vinyl (TD-2)
- Bright colors for high visibility

High Visibility Slow Moving Vehicle Emblems

- Choice of aluminum (TA-5) or adhesive vinyl (TD-5)
- Meets American Society of Agricultural Engineers S276.5 Certified SMV Emblem Specifications

**10X as bright!
Lasts 2X as long
as standard material!**



TA-1 / TD-2

TA-1
Aluminum Emblem
SIZE: 16" x 14"
PACK: 12 Each
WEIGHT: 7.72 Lbs.

TD-2
Vinyl Emblem Decal
SIZE: 13.75" x 15.75"
PACK: 12 Each
WEIGHT: 1.36 Lbs.



TA-5 / TD-5

TA-5
Aluminum Emblem
SIZE: 16" x 14"
PACK: 12 Each
WEIGHT: 7.72 Lbs.

TD-5
Vinyl Emblem Decal
SIZE: 13.75" x 15.75"
PACK: 12 Each
WEIGHT: 1.36 Lbs.

6" x 12" Identification Tag

- Weather-resistant
- Made of rustproof aluminum
- Pre-punched holes for easy mounting



20550

SIZE: 6" x 12"
PACK: 5 Each
WEIGHT: .84 Lbs.

ACCESSORIES

SMV BLADE SUPPORT
SIZE: 2" x 11"
PACK: 12 Each
WEIGHT: 5.46 Lbs.



VB-2

SMV MOUNTING SOCKET
SIZE: 2.5" x 2.0"
PACK: 12 Each
WEIGHT: 2.42 Lbs.



VS-3

Novelty Signs

- Fun, colorful designs
- Use indoors or outdoors
- Made of durable polyethylene



20541



20542



20544

SIZE: 10" x 14"
 PACK: 5 Each
 WEIGHT: 1.37 Lbs.

Rural/Urban Signs

- Weather-resistant
- Made of rustproof aluminum
- High visibility signs used to promote public and private safety



20521



20523

SIZE: 12" x 18"
 PACK: 1 Each
 WEIGHT: .60 Lbs.

11" x 11" Heavy-Duty Plastic Signs

- Weather-resistant
- Durable
- Bright & highly visible

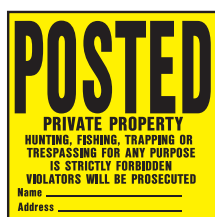

YP-1



YP-2



YP-3



YP-5



YP-6



YP-7



YP-10



YP-12

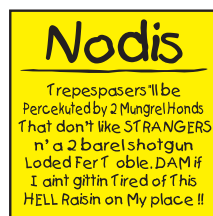

YP-16



YP-17



CFS-7



CFS-8

SIZE: 11" x 11"
PACK: 20 Each
WEIGHT: 2.30 Lbs.

Plastic Posted Sign Kit

- Weather-resistant
- Durable
- Bright & highly visible



YP-1VP

CONTENTS: 10 Each Plastic
11" x 11" "POSTED" Signs Per Kit
PACK SIZE: 11" x 12.5"
PACK: 1

Tyvek® Posted Sign Kit

- Weather- & tear-resistant
- Bright colors for high visibility
- Easily mount to trees, fences, poles, etc.



PP-1
CONTENTS: 10 Each
11"X11"Tyvek "POSTED" signs per kit
PACK SIZE: 14.50" X 12.25"
PACK: 1 Each
WEIGHT: .30 Lbs.

Tyvek® Posted Sign Roll

- Weather- & tear-resistant
- Bright colors for high visibility
- 100 perforated signs per roll
- Display racks available:
RW-2GTSR 1-pocket basket
RW-TSR 6-pocket wire rack

SIZE: 11" X 11" Signs on 3" Roll
PACK: 1 Each
WEIGHT: 1.14 Lbs.

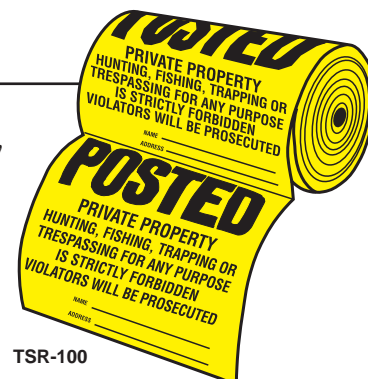

TSR-100

6" x 14" Plastic Fence Signs

- Weather-resistant
- Durable
- Bright & highly visible

BEWARE OF DOG

23001

**NO
PARKING**

23002

**NO
SMOKING**

23003

**POSTED
NO TRESPASSING
KEEP OUT**

23004

**AUTHORIZED
PERSONNEL
ONLY**

23005

**PRIVATE
PROPERTY
KEEP OUT**

23006

**PRIVATE
DRIVE**

23007

KEEP GATE CLOSED

23008

**EMERGENCY
911**
POLICE
FIRE DEPT.
PARAMEDIC
RESCUE UNIT
DJAL

23009

Regulatory Signs

- Weather-resistant
- Printed on durable materials

SIZE: 6" X 14"
PACK: 5 Each
WEIGHT: .9 Lbs.

WARNING

UNDER FLORIDA LAW,
AN EQUINE ACTIVITY
SPONSOR OR EQUINE
PROFESSIONAL IS NOT
LIABLE FOR AN INJURY
TO, OR THE DEATH OF,
A PARTICIPANT
IN EQUINE ACTIVITIES
RESULTING FROM
THE INHERENT RISKS OF
EQUINE ACTIVITIES

20529 FLORIDA

WARNING

UNDER GEORGIA LAW, AN EQUINE
ACTIVITY SPONSOR OR EQUINE
PROFESSIONAL IS NOT LIABLE
FOR AN INJURY TO OR DEATH OF A
PARTICIPANT IN EQUINE ACTIVITIES
RESULTING FROM THE INHERENT
RISKS OF EQUINE ACTIVITIES,
PURSUANT TO CHAPTER 12 OF
TITLE 4 OF THE OFFICIAL CODE
OF GEORGIA ANNOTATED.

OCSA Title 4 Chapter 12

20530 GEORGIA

MATERIAL: Aluminum
SIZE: 12" x 18"
PACK: 1 Each
WEIGHT: .60 Lbs.

Spanish Bilingual Hy-Glo Signs

- Weather-resistant
- Durable
- Bright & highly visible colors
- Shows both Spanish and English sign wordings



3066



3070

SIZE: 8.5" x 12"
PACK: 10 Each

15" x 19" Spanish Bilingual Polystyrene Sign

- Weather-resistant
- Bright, bold colors for high visibility
- Shows both Spanish and English sign wordings

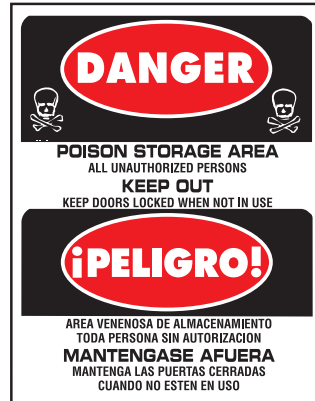

CFS-5

SIZE: 15" x 19"
PACK: 5 Each
WEIGHT: 1.50 Lbs.

9.25" x 14" Spanish Bilingual Aluminum Signs

- Weather-resistant
- Pre-punched mounting holes & rounded corners
- Shows both the Spanish and English sign wordings

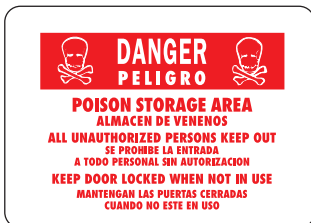

CFS-1

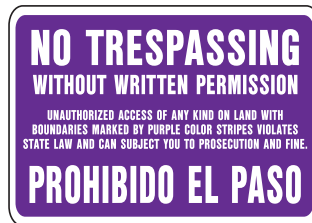

SS-50

Illinois, Kansas, Missouri,
North Carolina, Texas

*(Purple color sign can
be used to designate
property boundaries.)*

SIZE: 9.25" x 14"
PACK: 12 Each
WEIGHT: 1.96 Lbs.

Aquatic Safety Signs



Whether for relaxation, exercise or sport, aquatic activities are popular. But precautions need to be taken around both public and private facilities to ensure the enjoyment lasts.

Help your customers prevent unnecessary accidents and lawsuits with Hy-Ko's weather- and tear-resistant safety signs for pools, spas, beaches and other waterfronts. Included are those postings required by local, state and federal law.

Emergency Notification Sign (CPR Sign)

- Meets many local, state and federal law requirements
- Weather-resistant
- Made of durable polyethylene

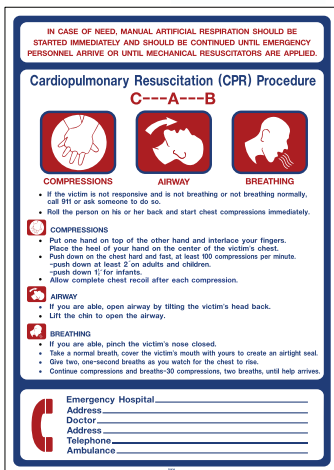

20434

SIZE: 20" x 28"
PACK: 5 Each
WEIGHT: 3.50 Lbs.

Swimming Pool & Spa Signs

- Weather-resistant
- Made of durable polyethylene
- Bright, attention-getting colors



20401

SIZE: 28" x 20"
PACK: 5 Each
WEIGHT: 3.50 Lbs.



20407

SIZE: 18" x 12"
PACK: 5 Each
WEIGHT: 1.98 Lbs.

Regulatory Signs

- Meets individual state requirements
- Durable polyethylene
- Large size for maximum visibility



20411 CALIFORNIA



20412 FLORIDA

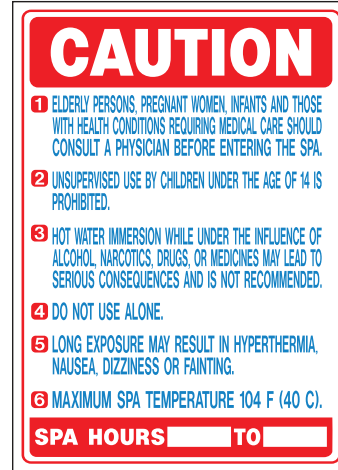

20415 CALIFORNIA

SIZE: 20" x 28"
PACK: 5 Each
WEIGHT: 3.50 Lbs.



20423

SIZE: 14" x 20"
PACK: 5 Each
WEIGHT: 1.98 Lbs.



20425

SIZE: 10" x 14"
PACK: 5 Each
WEIGHT: 1.35 Lbs.



20436

SIZE: 10" x 14"
PACK: 5 Each
WEIGHT: 1.35 Lbs.



20481

SIZE: 10" x 14"
PACK: 5 Each
WEIGHT: 1.35 Lbs.

Product Index

Hy-Ko Item	Description	Page(s)
402 to 448	2" x 8" Press-On Aluminum Princess Signs	42
470-473	2" x 8" Self-Adhesive Vinyl Graphic Signs	42
483-484	2" x 8" Vinyl Self-Adhesive Fuel Safety Signs	63
500-GF	House Numbering Kit	27
501 to 592	10" x 14" Polyethylene OSHA & Safety Signs	61
601 to 602	8" x 12" Vinyl Hy-Glo Static Cling Signs	45
610	4" Removable, Low-Tac Numbers, Letters & Symbols	12
700 to 703	15" x 19" Heavy-Duty Plastic Parking Signs	60
750 to 754	20" x 24" Heavy-Duty Plastic Real Estate Signs	35
801 to 848	Orange/Black Aluminum Hy-Glo Signs	40
911	4.875" x 18" Address Plate with 3" Reflective Numbers	27
920 Series	5" Reflective High-Visibility House Numbers	17
3000 to 3045	Plastic Hy-Glo Signs	30-31
3060 to 3075	Spanish Bilingual Plastic Hy-Glo Signs	46
20401	20" x 28" Polyethylene Pool/Spa Sign	76
20407	12" x 18" Polyethylene Pool/Spa Sign	76
20411 to 20415	20" x 28" Polyethylene Regulatory Pool/Spa Signs	77
20423	14" x 20" Polyethylene Regulatory Pool/Spa Sign	77
20425, 20436, 20481	10" x 14" Polyethylene Regulatory Pool/Spa Signs	77
20434	20" x 28" Polyethylene Emergency CPR Sign	76
20521 to 20523	12" x 18" Aluminum Rural/Urban Signs	72
20529 to 20530	12" x 18" Aluminum Regulatory Signs	74
20541 to 20544	10" x 14" Polyethylene Novelty Signs	72
20550	6" x 12" Aluminum FARM USE Tag	71
20601 to 20619	Red/White Plastic Signs	31
20645 to 20648	9" x 12" Lead Warning Signs	62
20691 to 20693	Red/Black/White Plastic Signs	31
20702 to 20707	15" x 19" Jumbo Plastic Signs	32
22102 to 22106	Multicolor Plastic Sell-It-Yourself Signs	53
22130	Take One Tube	39
22131	Take One Box	39
22601 to 22616	12.75" x 13" Multicolor Plastic Sell-It-Yourself Signs	53
22650H	12.75" x 13" Plastic Hy-Glo Sign	33
22902 to 22913	13" x 13" Licensed Sell-It-Yourself Signs	54
23001 to 23009	6" x 14" Plastic Fence Signs	34, 74
30003 to 30035	Packaged Self-Stick Vinyl Numbers and Letters	13
30101 to 30103	Adhesive Price Labels	54
30200 Series	6" Black Plastic House Numbers	16
30300 Series	6" White Plastic House Numbers	16
30400 Series	3" Black Vinyl Die-Cut Self-Stick Numbers & Letters	8
30500 Series	3" White Vinyl Die-Cut Self-Stick Numbers & Letters	8

Hy-Ko Item	Description	Page(s)
30600 Series	4" Reflective Plastic House Numbers	17
40601 to 40604	Wooden Sign Stakes	39
40610 to 40617	Window Markers	55
40622 to 40623	Permanent Sign Markers	55
40640 to 40641	Metal Sign Stake & Wire H-Bracket Sign Frame	39
AK-270	Mailbox Name and Address Kit	27
AK-300	Natural Cedar Address Plaque	27
AK-400	All-in-One Black Plastic Address Kit	27
AK-450 to AK-461	Oval & Rectangular Prestige Address Plaques	22
AK-TL3 to AK-TL5	Scrolled Tile Address Plaques	25
BR-40 & BR-41 Series	4" Solid Brass House Numbers & Letters	18
BR-42PB & BR-42OWB Series	4" Polished Brass & Old-World Bronze House Numbers	23
BR-43BB & BR-43SN Series	4" Brushed Brass & Satin Nickel House Numbers	23
BR-50 Series	5" Solid Brass 3D House Numbers	18
BR-51PB & BR-51SN Series	5" Polished Brass & Satin Nickel House Numbers	24
BR-90 Series	4" Solid Brass 3D House Numbers	18
CA-25 Series	3-1/2" Reflective Aluminum House Numbers	17
CAR-300 to -305	Poly Safety Tape Rolls	64
CDRF-3 to CDRF-5 Series	Carded Reflectors	69
CFS-1	10" x 14" Spanish Bilingual Aluminum Sign	46, 75
CFS-5	15" x 19" Spanish Bilingual Polystyrene Sign	46, 75
CFS-7, CFS-8	11" x 11" Heavy Duty Plastic Signs	33, 73
CMR-10	Carded Mini-Reflectors	69
CORB-6 to CORB-7 Series	Carded Reflectors	70
CV-2	Self-Adhesive Vinyl Industrial Sign	64
D-0 to D-40	Plastic Deco Designer Graphic Signs	43
DB-1 to DB-19	Plastic Braille/Tactile Designer Graphic Signs	44
DC-3 Series	3-1/2" Black Aluminum Die-Cast Address Numbers/Letters	15
DC-4 Series	4-1/2" Black Aluminum Die-Cast Address Numbers	15
DC-5 Series	4-1/2" Black Aluminum Dimensional Die-Cast Address Numbers	15
DCG-3 Series	3" Simulated Gold Die-Cast Aluminum Address Numbers/Letters	15
DCW-3 Series	3" White Aluminum Die-Cast Address Numbers/Letters	15
DM100 -36 and DM100 -48 Series	36" & 48" Standard Aluminum Markers	67
DM300 -36 and DM300 -48 Series	36" & 48" Fiberglass-Reinforced Markers	67
DM80048 & DM80048G	48" Fiberglass-Reinforced Safety Markers	68
DM80054, DM80072	54" & 72" Orange Fiberglass-Reinforced Safety Markers	68
DM800VP6	Value Pack of 6 - 48" Orange Fiberglass-Reinforced Safety Markers	68
DMD80048 Series	48" Road Markers	68
DRF-3 Series	Bracketed Reflectors	70
DRF-5 Series	Nail-On Reflectors	70

Product Index

Hy-Ko Item	Description	Page(s)
EE-2 to EE-3	Vinyl Glow-In-The-Dark Safety Signs	62
FA-1.	Vinyl Glow-In-The-Dark Arrow Sign	62
FE-1.	Vinyl Glow-In-The-Dark Fire Extinguisher Sign	62
FE-2L.	Vinyl Glow-In-The-Dark Fire Extinguisher/Left Arrow Sign	62
FE-2R	Vinyl Glow-In-The-Dark Fire Extinguisher/Right Arrow Sign	62
FH-1	Vinyl Glow-In-The-Dark Fire Hose Sign	62
FM-6 Series.	6" Satin-Black Architectural House Numbers	26
FRAME-1.	Heavy Duty Metal Sign Frame	38
FRAME-2.	Heavy Duty Metal Sign Frame	38
FRAME-3.	Heavy Duty Metal Sign Stake	38
GB-7 Series.	7" Simulated Wood-Grain Numbers & Letters	16
GG-25	3-1/2" Press-On Gold Aluminum Numbers, Letters & Symbols	8
GR-10	1-1/2" Press-On Gold Aluminum Numbers, Letters & Symbols	8
HSV-8 to HSV-102	Vinyl Graphic Signs	44
HW-1 to HW-64	12" x 18" Heavy Duty Aluminum Highway Signs	58-59
HW-22.	12" X 12" DO NOT ENTER Sign	59
HW-31.	18" Aluminum STOP Sign	59
HW-48.	9" X 12" Maximum Penalty \$250 Sign	59
HW-54.	6" x 12" Reflective Aluminum Sign	60
HW-62.	16" Aluminum SLOW Sign	59
HW-65.	24" Aluminum STOP Sign	59
HW-67 to HW-69.	9" x 9" Aluminum Truss Signs (Florida)	60
KIT-2.	14" x 19" Garage Sale Sign Kit	45
KIT-6, KIT-7	Self-Adhesive Vinyl Decorative Flag Decals	54
KIT-13 to KIT-15	9" x 12" Plastic Garage & Auto For Sale Sign Kits	45
LBL-7	Corrugated Plastic Blank Lawn Sign	35
LFR-4	Corrugated Plastic For Rent Lawn Sign	35
LFS-1	Corrugated Plastic For Sale Lawn Sign	35
LFS-301	59" Corrugated Plastic Lawn Sign with Take One Pouch	52
LFW-8	Corrugated Plastic Freeze Warning Lawn Sign	35
LGS-2	Corrugated Plastic Garage Sale Lawn Sign	35
LM500 -36 and LM500 -48 Series	36" & 48" Heavy-Duty Aluminum Markers	69
LOH-3	Corrugated Plastic Open House Lawn Sign	35
LYS-5	Corrugated Plastic Yard Sale Lawn Sign	35
MM-1 to MM-244-W	Standard Packaged Numbers & Letters	10-12
MM-31 TO MM-43	Prism Packaged Numbers & Letters	14
MM-200B & MM-200W	2-3/8" Molded, Self-Adhesive Packaged Numbers	14
MYO-1.	14" x 18" Corrugated Plastic Sign	31
PEN-2 & PEN-3.	50' Multicolored Polyethylene Pennant Flags	54
PFS-11	20" Corrugated Plastic Safety Floor Stand	64

Hy-Ko Item	Description	Page(s)
PLS-10	32.5" x 25" Parking Lot Stencil	64
PLS-50 to PLS-55	Heavy-Duty Plastic Parking Lot Stencils	65
PLS-60 to PLS-67	Large Parking Lot Stencils	65
PN-29 Series	4" Black Plastic 3-D Plastic House Numbers	16
PP-1	11" x 11" TYVEK Posted Sign Kits (10)	34, 73
PS-20 Series	3 1/4" Bend & Peel Reflective Vinyl Numbers	8
REC-1	10" x 14" Plastic Boat For Sale Sign	32
RS-601 to 607	18" x 24" Plastic Double-Sided Signs	38
RS-801 to 806	10" x 24" Corrugated Plastic Lawn Signs	36
RSF-601 to 605	18" x 24" Plastic Real Estate Signs with Frames	37
RV-15 to RV-80	1" to 6" Self-Stick Reflective Vinyl Numbers/Letters/Symbols	9
SC-12 to SC-36	12"-18"-28"-36" Orange Day-Glo Vinyl Traffic Safety Cones	64
SF-21 Series, SF-24/O, SF-24/P	Vinyl Safety/Boundary Stake Flags/Pesticide Stake Flags	63
SI-2	3/4" Embossed Silver Numbers & Letters	12
SIY-201	14" x 18" Real Estate Sign & Frame	52
SM-2	10" x 14" Aluminum Sign	41
SP-100 to SP-117	Jumbo Plastic Orange/Black Hy-Glo Signs	32
SP-230	15" x 19" Spanish Bilingual Plastic For Sale Sign	46
SS-2W to SS-50	10" x 14" Aluminum Signs	41
SSP-101 to SSP-404 Series	Sell-It-Yourself Corrugated Plastic Signs	50-52
ST-1 to ST-6	Carded Number & Letter Stencils	19
T-24M,T-24U,T-24W	ADA/Title 24 Plastic Signs	44
TA-1, TA-5, TD-2, TD-5	Aluminum/Vinyl Slow-Moving Vehicle Emblems	60, 71
TAPE-1 to 4	2" x 24" Reflective Vinyl Safety Tapes	63
TL-40 Series	4" Ceramic Tile Number Series	25
TSR-100	11" x 11" TYVEK Posted Sign Rolls	34, 73
VB-2	Aluminum Slow-Moving Vehicle Blade Support	60, 71
VS-3	Aluminum Slow-Moving Vehicle Mounting Socket	60, 71
YAR-2	6.25" x 24" Corrugated Plastic Arrow Lawn Sign	36
YBL-7	20" x 24" Corrugated Plastic Yellow Black Lawn Sign	35
YFS-10	20" x 24" Corrugated Plastic For Sale Lawn Sign	36
YGS-5	6.25" x 24" Corrugated Plastic Garage Sale Lawn Sign	35
YHS-6	6.25" x 24" Corrugated Plastic Home For Sale Lawn Sign	36
YOH-3	6.25" x 24" Corrugated Plastic Open House Lawn Sign	36
YP-1 to YP-17	11" x 11" Heavy Duty Plastic Signs	33, 73

Placing an Order:

Hy-Ko's Customer Service Department is ready to help you place your order. For reference, you may follow the Order Form shown to the left, or you can copy, complete and fax the order to us for quick and easy handling.

Five Easy Ways to Order:

Phone: 330.467.7446 • 800.292.0550

(Monday - Friday, 8:30am - 6:00pm, Eastern Time)

Fax: 330.467.7442

(24 hours a day, seven days a week)

E-Mail: cservice@hy-ko.com

(Checked frequently during the work day)

EDI - Electronic Data Interchange

(24 hours a day, seven days a week)

Mail: Send your completed order form to:

Hy-Ko Products Company

60 Meadow Lane

Northfield, OH 44067-1415



Terms & Conditions

Pricing: Product prices are in U.S. funds and do not include GST or duties, provincial taxes, freight and importation charges. Prices and product specifications may change without notice.

Prices reflect the cost of the product when shipped from the factory (dropshipped).

Quotations: Any written price quotation remains in effect for thirty days from the time of the quotation, unless otherwise stated in writing.

Warranty: Hy-Ko Products Company provides quality products warranted to be free from defects in material and workmanship. Any products shown to be defective at the time of sale will be replaced promptly. Hy-Ko Products Company does not assume any liability for injury, loss or damage of any kind from the use of Hy-Ko's products.

Freight: Freight is charged on any dropshipped order less than \$100.00.

Damage/Shortage Claim: Please contact Hy-Ko's Customer Service Department at 1-800-292-0550 to notify us of damage or shortages.

Returns: Please contact Hy-Ko's Customer Service Department at 1-800-292-0550, for a return authorization. Prior arrangements should be made with Customer Service and should be authorized before the product is returned to Hy-Ko Products.

Custom Orders: Custom orders can only be cancelled prior to the start of manufacture. If the order is cancelled and it is in process, a fee may be charged.

Metric Conversion Table (Approximations)			
Unit (U.S.)		Metric	
1 inch	x 2.54	=	2.54 centimeters (cm)
1 foot	x 0.305	=	.305 meters (m)
3 feet	x 0.305	=	.915 meters (m)
Unit (U.S.)		Metric	
1 lb.(pound)	x 453.6	=	453.6 grams (g)
1 lb.(pound)	x .4536	=	.4536 kilograms (kg)



www.hy-ko.com

NLSCATALOG 0812

Hy-Ko Products Company

60 Meadow Lane, Northfield, OH 44067-1415
 330-467-7446 • 800-292-0550 • Fax: 330-467-7442 • E-Mail: cservice@hy-ko.com

