



Animal Management Solutions for Producers

Electric Fencing, Weighing, EID and Miraco Watering System Catalog



COVER:**NEW REVOLUTIONARY i SERIES FENCE
ENERGIZER SYSTEM**

Gallagher is always surprising you with innovative technologies and things that make you more efficient. See for yourself the impressive, new products and features we have recently unveiled like the i Series Fence Energizer System - the fence that can't keep a secret! (pages 6-9)



Producers know that when they purchase a Gallagher product, it comes with a heritage of quality and innovation that has made Gallagher the number one selling brand of animal management products in the world, since 1938.

TABLE OF CONTENTS

POWER SYSTEMS

Energizer Selection Chart	5
110 Volt Energizers	6
Battery Energizers	14
Solar/Battery Energizers	16
Solar Energizers	20
Grounding	22
Power Management Tools	23

FENCING SYSTEMS

Strainers, End Strain Insulators	24
Wood Post Insulators, Connectors & Clamps	25
Steel & Fiberglass Post Insulators	26
Offsets	27
Cable, Wire Braid & Tape	28
Reels	30
Posts , Pigtailed, Treadins, Fiberglass & Tumblewheels	31
Gates & Accessories	32
Netting & Woven Wire	34
Electric Fence Kits	35
Fence Setups	36
Recommended Systems	38
Fence Tools & Accessories	42

WEIGHING & ELECTRONIC IDENTIFICATION

Weighing & Data Collectors	44
Platforms	47
Loadbars, Readers & Accessories	48
Sheep Auto Drafter	51

MIRACO WATERING TANK SYSTEMS

Mirafount & E-Fount Waterers	54
Lil'Spring Tank Waterers	56
Miraco Installation Diagram	57
EquiFount Waterers	59
BigSpring Tank Waterers	60
Pet Waterer	61
Heaters & Accessories	61

4 Electric Fencing Basics

2 Year Warranty on All Gallagher Energizers!

All Gallagher Energizers carry a 2 year warranty* with Gallagher lightning protection, in addition to a 30-day money back customer satisfaction guarantee.

* includes lightning damage



How Electric Fencing Works

A short, safe and memorable shock to create a psychological as well as a physical barrier.

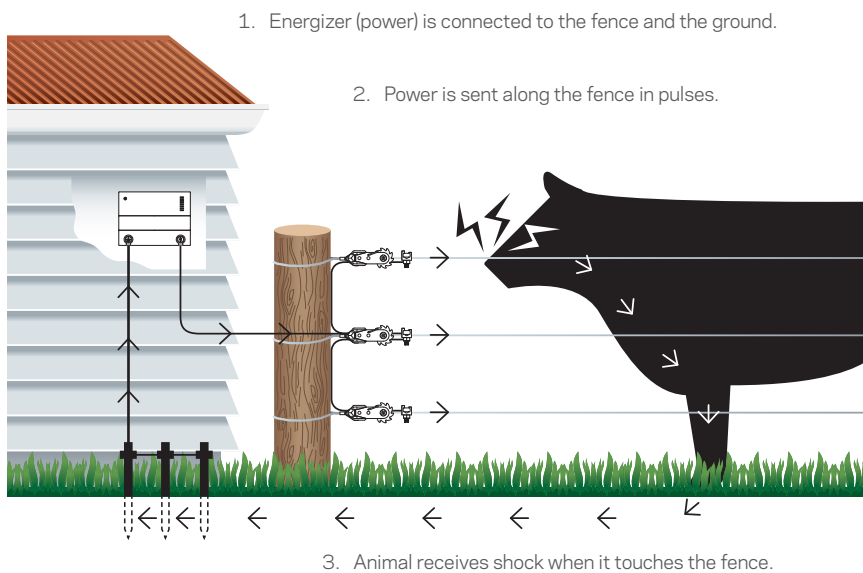

PROFITABLE

Maximize pasture growth, minimize feed costs

SAFE

Animals remember and develop a respect for the fence

DURABLE

Stock pressure on your fence is reduced so it lasts longer

EASY TO INSTALL

Less than half the time to build vs a non-electric fence

ECONOMICAL

Costs less to build and maintain than a non-electric fence

Getting Started

Every electric fence system is made up of an energizer, a grounding system and a fence system. Selection of these systems depends on property size, fencing usage and animal type.

1) What animals do you want to keep in or out? (See Gallagher Energizer Chart page 5)

2) Total area to be fenced (See Gallagher Energizer Chart page 5)

3) What power source will you use for your Energizer?

Gallagher 110 volt energizers are the best and most economical choice for areas where you have reliable power. Selected units have a battery backup for guaranteed animal control in areas where power may be unreliable. Solar/Battery or Solar powered energizers are the most logical for remote areas.

4) Do you need a permanent, temporary or offset fence?

- **Permanent:** Long life, permanent electric fences for highly effective animal control that lasts a lifetime.
- **Temporary:** Easy to transport, assemble and take down allowing flexible fencing for short-term animal control or rotational grazing.
- **Offset:** Protect and extend the life of an existing conventional non-electric fence by retrofitting electric wire(s).

Energizer Selection Chart 5















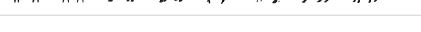









	ENERGIZER	ACRES	MULTIWIRE DISTANCE (MILES)	LIVESTOCK CONTROLLED
110 VOLT	MR5000	2000	75	
	M2800i Series	1000	50	
	M1800i Series	420	42	
	M1200i Series	300	37	
	M1000	250	34	
	M600	150	25	
	M300	85	17	
	M150	60	11	
	M100 Wrangler	30	6	
	M50 Rustler	20	3	
	M20 Yardmaster	8	1.3	
BATTERY	B40	25	3	
	B11	6	0.6	
	B10	6	0.6	
SOLAR / BATTERY	B1600	400	40	
	B700	200	25	
	B300	110	22	
	B280	110	22	
	B200	90	15	
	B180	90	15	
	B100	60	7	
	B80	55	8	
SOLAR	S50	30	5	
	S20	14	2	
	S17	10	1	

Table is a guide only. In dry conditions, Energizers have proven to work effectively for more than twice the distance. In high vegetation growth areas, distances may need to be reduced.

6 110 Volt Energizers

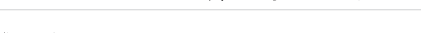
A 110V Energizer System is the best choice if you have reliable power.

All Gallagher 110V energizers have built in lightning protection and are tested under extreme conditions to ensure unbeatable reliability – delivering outstanding performance day in and day out. Our medium and large energizers offer extra performance with low power usage by automatically matching power output to fence load, as well as fence monitoring technology giving you total peace of mind your fence is working effectively.

M2800i

G306504

28
JOULES

- Multiwire distance ideal conditions: 1,000 acres /405 ha; 80km/50 miles
- Stored energy (joules): 28
- Dimensions: 344mm (w) x 223mm (h)
13.5" (w) x 8" (h)

i Series Energizer System - the fence that can't keep a secret. Working together the i Series system provides fence information at a glance and if it detects any faults, leads you directly to them, saving you hours of searching.



Energizer Remote & Fault Finder with user replaceable battery.

Fence Monitors placed strategically around your property provide confident animal control & accelerated fence troubleshooting.



Energizer Controller allows fence information to be seen in a convenient location up to 50m/160' away from the Energizer.

Energy efficient Energizers, adjusts power output to suit your fence conditions. Provides incredible fence performance for the unit's size.

INCLUDED



OPTIONAL ACCESSORIES



PRODUCTS IN DETAIL:

FENCE MONITOR



G51000

Sold separately

A watchful eye on all corners of your fence ↓

Add up to six monitors to your fence system to turn it into a fully monitored set up that keeps the Energizer Controller constantly up to date with fence performance.

- Use across your property to monitor fence voltage and current at up to six different locations (zones)
- Identifies when any zone has a fault and reports back alarms
- Locate fault zones quickly and use the Remote/Fault Finder to pinpoint the problem.

ENERGIZER CONTROLLER



(Not sold separately, included with M1200i, M1800i, M2800i)

Ground breaking innovation, total peace of mind that your fence is working as it should ↓

Shows all your fence performance information (e.g. voltage, faults and location) in one convenient, separate display box that can be placed up to 50m /160' away from the Energizer

- Displays voltage & current readings at the Energizer and for up to 6 attached Fence Monitors
- Locate in a convenient spot for instant updates eg: side of the shed
- Locate fault zones quickly & use the Controller to turn the Energizer on/off
- Fully waterproof for indoor or outdoor placement.

REMOTE



G50700

Sold separately

Save hours searching for & fixing faults ↓

The Remote pinpoints the fault within the monitored zone and enables you to turn off the Energizer during repair and on again once complete.

- Shows fence voltages and current
- Shows Alarm status for the Energizer and the Fence Monitors
- One Remote can be used on up to 9 Energizers or use multiple Remotes on one (or more) Energizers.

IN ACTION:

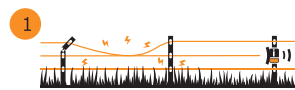

Fence Monitor(s) recognize any significant drop in fence zone or Energizer performance and raise alarms.



Alerts are sent to the Energizer Controller, your mobile phone (via optional SMS Energizer Controller) and/or optional Alarm System.



The Controller and Remote indicate which zone is in fault. The Remote is used to find the fault within the zone.



Power to the fence at the fault location is turned off using the Remote, allowing a safe and convenient repair.



Once the fault is repaired, power is restored to the fence and tested using the Remote.

SMS Energizer Controller ↓

Fence performance information sent via SMS text to your phone. Turn the Energizer on/off from your mobile.



G56760

Alarm System ↓

Monitor a section of fence and drive external strobe lights, sirens or alarm panels if the circuit is broken eg: gate opened or a wire cut.



Light G56901

Siren G56902



G57900

8 110 Volt Energizers

M1800i

G304504

18
JOULES

- Multiwire distance ideal conditions: 420 acres/170 ha; 67 km/42 miles
- Stored energy (joules): 18
- Dimensions: 344mm (w) x 223mm (h)
13.5" (w) x 8" (h)



Energizer Remote & Fault Finder with user replaceable battery.

Fence Monitors placed strategically around property to provide confident animal control & accelerated fence troubleshooting.



Energizer Controller allows fence information to be seen in a convenient location up to 50m/160' away from the Energizer.

Energy efficient Energizers, adjusts power output to suit your fence conditions. Provides incredible fence performance for the unit's size.

INCLUDED



OPTIONAL ACCESSORIES



M1200i

G303504

12

JOULES

- Multiwire distance ideal conditions: 300 acres/121 ha; 60 km/37 miles
- Stored energy (joules): 12
- Dimensions: 344mm (w) × 223mm (h)
13.5" (w) × 8" (h)

INCLUDED



OPTIONAL ACCESSORIES



Energizer Controller allows fence information to be seen in a convenient location up to 50m/160' away from the Energizer.

Energy efficient Energizers, adjusts power output to suit your fence conditions. Provides incredible fence performance for the unit's size.



10 110 Volt Energizers

MR5000

T376504

50
JOULES



- Multiwire distance ideal conditions: 2000 acres/200 ha; 120 km/75 miles
- Stored energy (joules): 50
- Dimensions: 220mm (w) × 310mm (h); 8" (w) × 7" (h)
- Built in remote control capability
- Enclosure design features improved output terminals and accessible DIP switches.
- Advanced lightning protection.

Training Livestock with Electric Fencing

All animals need time and space to discover that electrified fences are hot. This education period must occur under conditions of minimum stress. Select a small, well fenced holding pasture and place offset wires on the perimeter about two thirds the height (nose high) of the animals to be trained.

Ground the remainder of the fence to the Energizer ground and electrify the offset wires with the strongest possible pulse to help make the education process more effective.

If necessary, the remainder of the property can be disconnected to ensure the strongest possible shock during the training period.

Training time: the minimum time required is 12 hours and most animals will be fully trained in 48 hours. The aim is to have stock approaching the fences with caution.

Stock trained to electric fence systems will still respect the fence even if it is off for any reason (we do not recommend turning off an electric fence). Animals that have grown up with electric fence systems have remained in paddocks with the power off for several weeks. In recent years, many graziers have found electric fencing a highly efficient and low cost method of controlling unwanted wildlife.



"Power, performance and reliability – hallmarks of Gallagher 110 volt energizers"

M1000

G382504

10
JOULES

- Multiwire distance ideal conditions: 250 acres/101 ha ; 54 km/34 miles
- Stored energy (joules) : 10
- Dimensions: 245mm (w) × 190mm (h)
9.6" (w) × 7.5" (h)
- Quickscan Output Voltage: shows output voltage of the Energizer at a glance and a digital output reading
- Ideally suited for large pastures

LCD voltage and earth displays, provide quick reference to the grounding quality and fence performance.

Quick scan voltage bar graph shows how Energizer is performing at a glance.

Output and earth voltage alarms for better fence management.

Easy to service, modular design.

Green LED indicates normal operation.

Split bolt terminals for easy installation and good connection.

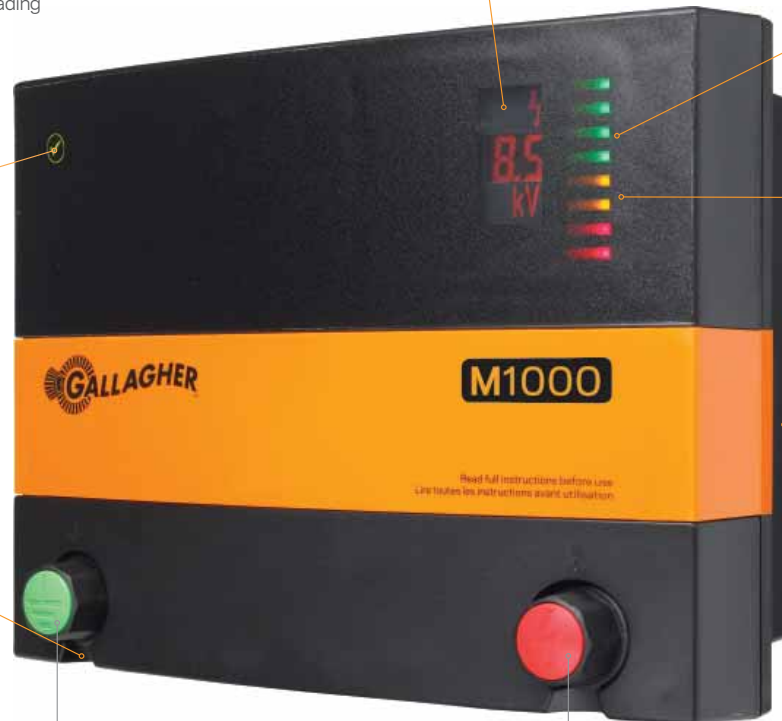

Terminals connect to:
Green - Ground
Red - Lead out Cable and Fence

M600

G381504

6
JOULES



- Multiwire distance ideal conditions: 150 acres/24 ha; 35 km/25miles
- Stored energy (joules) : 6
- Dimensions: 205mm (w) × 1.80mm (h)
8" (w) × 7" (h)
- Quickscan Output Voltage bar graph: shows output voltage of the Energizer at a glance
- Ideally suited for medium pastures

M300

G380504

3
JOULES



- Multiwire distance ideal conditions: 85 acres/12 ha; 25 km/17 miles
- Stored energy (joules) : 3
- Dimensions: 205mm (w) × 1.80mm (h)
8" (w) × 7" (h)
- Quickscan Output Voltage bar graph: shows output voltage of the Energizer at a glance
- Ideally suited for small pastures

12 110 Volt Energizers

M150

G328504

1.5
JOULES



- Multiwire distance ideal conditions: 60 acres/7 ha; 13 km/11 miles
- Stored energy (joules) : 1.5
- Dimensions: 205mm (w) × 160mm (h)
8" (w) × 6" (h)

- Indicator light flashes with every pulse
- Ideally suited for small pastures

M100

G330414

1
JOULES

- Multiwire distance ideal conditions: 30 acres/12 ha; 9 km/6 miles
- Stored energy (joules) : 1
- Dimensions: 190.5 mm × 243.84 mm
9.6" (w) × 7.5" (h)

- Green indicator light flashes when Energizer is working properly

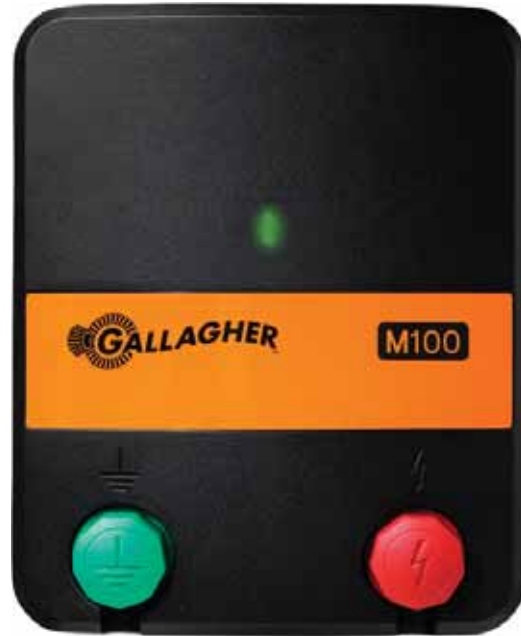

M50

G383404

0.5
JOULES

- Multiwire distance ideal conditions: 20 acres/8 ha; 5 km/3 miles
- Stored energy (joules) : 0.5
- Dimensions: 190.5 mm × 243.84mm
9.6" (w) × 7.5" (h)

- Maintains output voltage through heavy fence load



M20

G331414

0.2
JOULES

- Multiwire distance ideal conditions: 8 acres/3 ha; 2 km/1.3 miles
- Stored energy (joules) : 0.2
- Dimensions: 190.5 mm × 243.84 mm
9.6" (w) × 7.5" (h)

- Ideal for small farms, pets and gardens





What's your grazing strategy?

If there's one thing a cattle producer can count on, it's knowing they're going to face a challenge that's beyond their control. Whether that challenge is man made such as high operating costs, or a natural disaster such as a drought – or the combination of the two – each generation of producers deal with their own set of unique challenges.

But it's in the nature of cattle producers to accept their fate and make changes to their individual operations to stay in this business. And it is those exact challenges and the producer's ability to change what they can control that makes each generation of producers more progressive and aggressive in their operation management.

You can't feed yourself out of a drought. Surely one could try, but with current conditions as such, how long could that operation be sustainable, let alone be profitable? Instead, consider taking a different operation management approach to grazing and pasture management, such as rotational grazing. Picture utilizing what is already available: cattle and land, and change the way the two work together to ultimately produce a more efficient, cost-effective and viable operation for the future.

Rotational grazing, or intensive grazing, doesn't have to be overwhelming. It's simply utilizing the cattle and maintaining the land to garner the most efficiency out of an operation. And since producers already know the tendencies of their land and their animals, a little planning and strategy at the beginning will ensure a successful pasture management practice.

The limiting factor for a rotational grazing system is water. Determine the location of the cattle's water source first. Cattle will graze more efficiently if they are no farther than 243 – 304 meters (800-1,000) from their drinking source.

Next, chart out the grazing area on paper before heading out to pasture. Making a plan of the grazing area ahead of time allows producers to be more efficient and cost-effective in their rotational grazing management. An aerial map of the land is a great place to start to establish paddock sizes based on the location of the water source. If an aerial map is not available, the Natural Resources Conservation Service (NRCS) may provide this free of charge.

Determining the number of paddocks or the shape of the grazing area is solely up to each producer and their individual operation. Developing a rotational grazing system truly can be as simple as dividing the current grazing area in half.

A great visual example is to picture a pie shape – with the water source in the center of the pie and paddocks arcing out from the water. A rotational grazing system based on this principle allows producers to easily move cattle from one paddock to the next, especially when working alone.

Probably the most important question to ask when deciding the number of paddocks to create is: how long do I want the cattle to graze in each paddock? The more paddocks – the shorter amount of time the cattle will graze. As a general rule, four/five paddocks are quite typical.

It's time to put the plan in motion. For the physical component of rotational grazing – putting up the actual grazing area, producers need nothing more than five tools: an Energizer, ground rod, posts, reels and Poly Wire fencing. One of the great benefits of rotational grazing is flexibility; it may take a couple of rotations to figure out the appropriate size of the individual paddocks, which is why Poly Wire fencing is recommended at the beginning.

Before turnout, plan a quick grazing strategy. Take a look at the grazing area to determine the condition of the plots, availability of forage and how the pasture grows. A simple grazing strategy allows producers to know where to place the cattle in the grazing rotation and to prevent overgrazing. A general rule is to let the cattle eat the best forage first and then move the cattle to where the producer wants the animals to graze next.

How often a producer moves their cattle is based on many factors: geography, climate, season, size of the pasture – and also the number and size of paddocks. The smaller the size of the paddock, the shorter amount of time the cattle will spend in each area. In some parts of the country the cattle may be moved every couple of days, while in other parts, it may be weeks. The best advice is to watch what's happening in the rotational grazing process and make operation management decisions from there.

Regardless of current or future challenges, cattle producers will rise to the occasion. The progressive changes producers implement in their operations now, will continue to drive the success and sustainability of the industry as a whole to the next generation.

Tips

- Implementing a rotational grazing system allows producers to be more involved in the effectiveness of their forage and how efficiently their cattle graze.
- Cattle must be trained to electric fencing prior to turnout. Temporary fencing is a cost-effective solution to ensure the animals are ready.
- A simple equation to use to determine the number of paddocks to create: number of days of pasture rest divided by the number of days of grazing, plus one.

14 Battery Energizers

A Battery Powered Energizer System needs a constant current.

If not recharged, the battery will eventually become completely discharged and the Energizer will stop. The amount of current required by an Energizer increases with the size of the Energizer. The amount of charge stored by the battery is measured in Amp-hours (Ah) and increases with the size of the battery. A battery should be chosen which is designed for regular charge and discharge cycles, and for discharging most of its capacity without damage.

Deep cycle batteries are recommended as they are the best compromise between price and life expectancy. A deep cycle battery will typically last two to four times longer than an automotive battery when used for powering energizers because they are designed to be drained and recharged repeatedly.

Batteries should be placed on a level surface and can be protected against extremes of temperature. They should not be in direct contact with a cold surface such as the ground. Placing suitable insulating material under the batteries or placing them in a battery box and burying the box will also help increase their service life. Ensure that the battery has adequate ventilation to allow gases to escape.

B40

G38631

0.4
JOULES

- Multiwire distance ideal conditions: 25 acres/5 ha; 6 km/3 miles
- Stored energy (joules): .4
- Dimensions: 250mm (w) x 300mm (h)
9.8" (w) x 11.8 (h)

Requires: 12 volt rechargeable battery or 9V dry cell battery (G51400).
Battery not included.

Flashing red indicator shows immediately if battery running low.

Easy transportation, with carry handle plus convenient earth stake and leads storage.

Maximize animal control and battery life - choose full power or night save (to save battery life by up to 50%).

Designed for outdoor use, with super tough impact resistant case.



9V BATTERY
G51400
Use with Gallagher
B40 Energizer.



B11

G353414

0.11
JOULES

- Multiwire distance ideal conditions: 6 acres/.5 ha; 1 km/.6 miles
- Output energy (joules) : 0.09
- Dimensions: 115mm (w) x 220mm (h)
4.5" (w) x 8.6" (h)

Requires: Six 'D' batteries or external 12V battery (not included). 12V battery leads included.



Ideal for strip grazing.

Extend battery life with adjustable battery-save options.

B10

G36311

0.08
JOULES

- Multiwire distance ideal conditions: 6 acres/2.5 ha; 1 km/.6 miles
- Stored energy (joules) : 0.08
- Dimensions: 76 mm (w) x 152.4 mm (h)
3" (w) x 6" (h)
- Ideal for protecting gardens from animals.

Requires: Six 'D' batteries or external 12V battery (not included). 12V battery leads not included. 12V leads (G52100).



16 Solar/Battery Energizers

A Battery/Solar Energizer System is a popular choice for those without reliable mains power. These Energizers may be operated with or without a solar panel.

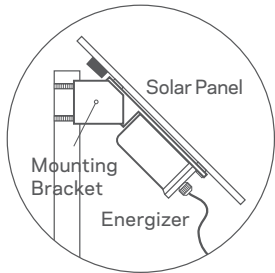

A full Gallagher solar kit set includes:

- High quality fully tested Solar Panels
- A Regulator to protect the battery by controlling the power flow
- Purpose selected deep cycle battery (can be purchased at most hardware stores)
- Stainless steel Mounting Brackets, Bolts & Clamps for longer life with multiple tilt positions for maximum sunlight exposure

Solar Panels

Watt Power Output
(for charging a 12 volt battery)



B1600

G39600

16
JOULES

- Multiwire distance ideal conditions: 400 acres/60 ha; 60 km/40miles
- Stored energy (joules): 16
- Dimensions: 220mm (w) x 210mm (h)
8.6" (w) x 8.3" (h)
- For remote areas with charging facilities
- Compatible with 85 watt panel
- Complies to RFI (Radio Frequency Interference) standards and has built-in lightning protection circuitry
- Battery consumption, 1,200 milliamps on high power mode and 300 milliamps on maximum save mode
- May be ordered as a solar package (AFR1600)

Quick glance green light shows battery is ok. Flashes red if battery is running low and Energizer slows to half speed to conserve energy.

Flexibility in fence management - choose high, medium or low power operating modes. Also includes low and full output power terminals to operate independently on different fences.



Red light flashes intermittently or not at all if fence is overloaded.

Terminals connect to:
Green - Ground
Yellow - Low Power
Red - Fence Output

Uses a 12- Volt deep cycle rechargeable, marine-type battery. Battery not included.
Use with 85W Solar Panel A80

B700

G39500

7
JOULES

- Multiwire distance ideal conditions: 200 acres/35 ha; 40km/25 miles
- Stored energy (joules): 7
- Dimensions: 220mm (w) × 200mm (h)
8.6" (w) × 7.9" (h)
- One fully charged 12 volt 100 amp hour battery will operate for approximately 8 days on high power, 14 days on low power
- Compatible with a 40W Solar Panel
- May be ordered as a Solar Package



Neon fence light flashes intermittently or not at all if fence is overloaded.

Uses a 12- Volt deep cycle rechargeable, marine-type battery. Battery not included.

Flashing red light shows when battery is low and Energizer slows to half speed to conserve energy.

Switch to select high or low power.

B280

G366514

2.8
JOULES

- Multiwire distance ideal conditions: 110 acres/15 ha; 35 km/22 miles
- Stored energy (joules) : 2.8
- Dimensions: 205mm (w) × 160mm (h)
8" (w) × 6" (h)
- Built in battery-save feature extends battery life.
- Easy to use 5-stage rotary dial to change Energizer operating functions.
- May be ordered as a Solar Unit (T36655)
- Convert to 110v (G40100) optional

Rotary dial to change Energizer operating functions.

- Battery Check
- Off
- Full Power

Battery save modes

- Random pulse 2.6x more battery life
- Night save 1.8x more battery life

Quick glance indicator light shows battery and fence voltage performance.



Split bolt recessed terminals for easy installation and good connection.

18 Solar/Battery Energizers

B300

G39400

2.6
JOULES

- Multiwire distance ideal conditions: 110 acres/15 ha; 30 km/22miles
- Output energy (joules) : 2
- Dimensions: 320mm (w) × 380mm (h)
12.6" (w) × 15" (h)
- Highly visible low-battery and fence-voltage indicator lights
- Carrying handle for easy transportation
- Weatherproof enclosure to contain battery
- May be ordered as a solar unit (G394SK)
- Replacement fence and ground leads (G57300)
- Unit has a hole in the bottom enabling it to be staked to prevent theft

B200

G393454

1.45
JOULES

- Multiwire distance ideal conditions: 90 acres/10 ha; 20 km/15 miles
- Stored energy (joules) : 1.45
- Dimensions: 320mm (w) × 380mm (h)
12.6" (w) × 15" (h)
- Highly visible low-battery and fence-voltage indicator lights
- Carrying handle for easy transportation
- Weatherproof enclosure to contain battery
- May be ordered as a solar unit (G393SK)
- Replacement fence and ground leads (G57300)
- Unit has a hole in the bottom enabling it to be staked to prevent theft

Uses a 12- Volt deep cycle rechargeable, marine-type battery. Battery not included.

Quick glance indicator lights show battery and fence performance.

Flexible fence management - choose from full or half power mode to extend battery life.

Carry handle for easy transportation.

Versatile animal control - vary Energizer pulse modes to suit different animals.

Easy battery installation, with simple clip lock case.



B100

G392454

0.8
JOULES

- Multiwire distance ideal conditions: 60 acres/24 ha; 11 km/ 17 miles
- Stored energy (joules) : 0.8
- Dimensions: 320mm (w) × 380mm (h)
12.6" (w) × 15" (h)
- Highly visible low-battery and fence-voltage indicator lights
- Carrying handle for easy transportation
- Weatherproof enclosure to contain battery
- May be ordered as a solar unit (G392SK)
- Replacement fence and ground leads (G57300)
- Unit has a hole in the bottom enabling it to be staked to prevent theft

Shown here with solar panel. Please ask about our Solar Kit.



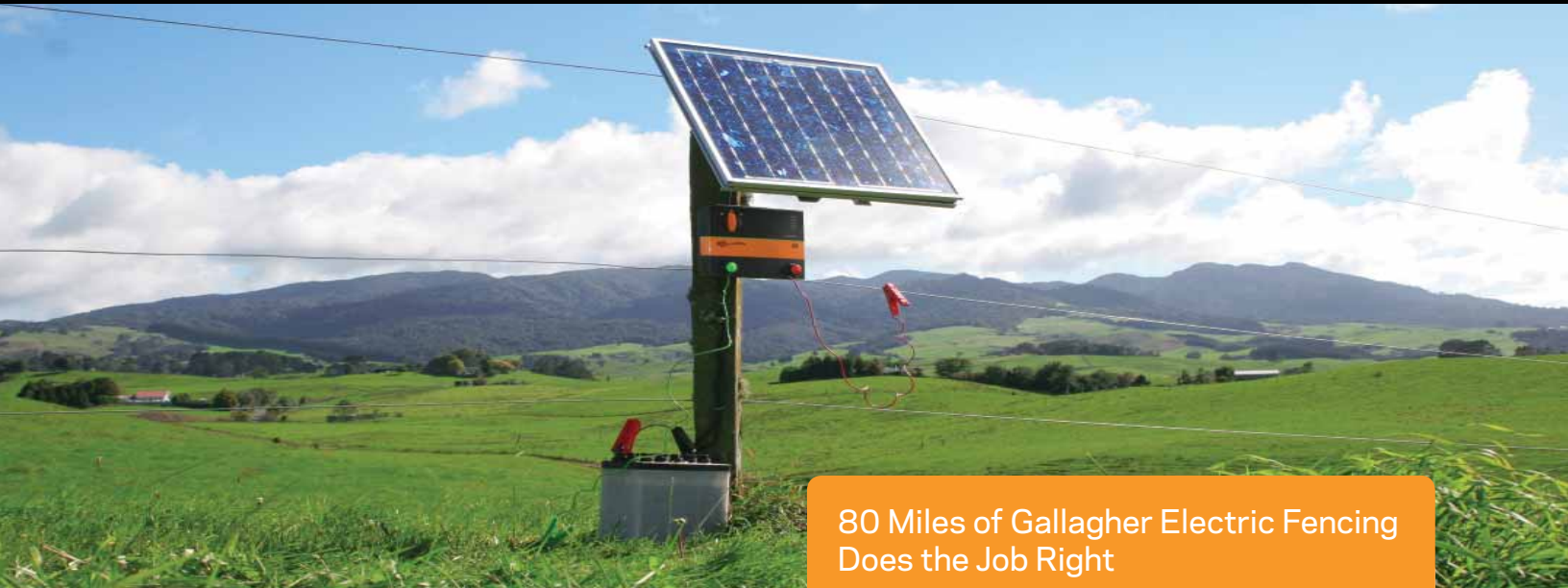

80 Miles of Gallagher Electric Fencing Does the Job Right

B180

G364504

1.8
JOULES



- Multiwire distance ideal conditions: 90 acres/10 ha; 25 km/15 miles
- Stored energy (joules): 1.8
- Dimensions: 205mm (w) x 160mm (h)
8" (w) x 6" (h)
- Built in battery-save feature extends battery life.
- Easy to use 5-stage rotary dial to change Energizer operating functions.
- Compatible with 10 Watt Solar Panel

B80

G362504

0.8
JOULES



- Multiwire distance ideal conditions: 55 acres/22 ha; 13 km/8 miles
- Stored energy (joules): 0.8
- Dimensions: 205mm (w) x 160mm (h)
8" (w) x 6" (h)
- Built in battery-save feature extends battery life.
- Easy to use 3-stage rotary dial to change Energizer operating functions.
- Compatible with 10 Watt Solar
- Convert to 110V (G40100)
- Optional solar package (T36255)

Doak Elledge makes good use of electric fencing on the 4,451 hectare Faudree Ranch, near Pampa, TX. The ranch is made up of 60 permanent pastures, varying from 6 - 275 hectares. About 70 hectares of improved pasture is subdivided with temporary fencing using Gallagher Tumblewheels and reels with Poly Tape.

"We have been using electric fencing since 1982," says Elledge. "We use 2 and 3 wire fence on permanent divisions and signal wire with temporary fencing. We run one herd of 450-500 cows in the summer and we pasture another, 850-900 yearlings."

"The main reasons we went to electric fencing were the lower costs and the maintenance efficiencies. We can construct approximately 6-11 kilometers of electric fence at about the same cost for 1 mile of barbed wire fence."

For new cattle, Elledge uses training traps with 4 and 5 wire electric fence. "Usually, after 1-2 days the cattle leave the fences alone," explains Elledge. "Most of the fence with the cow herd is 2 wire. The bottom wire is ground and the top wire is hot. This way, when the calves are young they can cross back and forth."

"We are constructing many of our fences with Gallagher Fiberglass posts," says Elledge. "So far, we really like this new type of fence. There are a lot of new products for electric fencing and they offer real advantages over the old style of construction, but even at that some of our 10 year old electric fences are still holding up well."

20 Solar Energizers



Gallagher produces high quality, reliable solar systems that are a cinch to install and will last for years.

S50

G359404

0.5
JOULES

- Multiwire distance ideal conditions: 30 acres/3 ha; 8 km/2 miles
- Stored energy (joules): 0.5
- Dimensions: 430mm (w) x 460mm (h)
17" (w) x 18" (h)
- Safe, powerful animal control designed for outdoor and portable use
- Can be mounted on a wall, wood post, T-Post, or sit on the ground
- Highly visible rotary dial for turning the unit off and on
- Impact resistant plastic lens to protect the solar panel
- Easy to maintain and clean
- Maintenance-free rechargeable battery included

Can be used for both permanent and portable fencing as it can be mounted on a wall, wooden post, t-post or placed on the ground.

LED light indicates normal operation.

Automatic Night Save mode to extend battery life.

Large rotary dial makes it easy to check unit is on from a distance.



12V rechargeable battery and fence leads included.

S50 RECHARGEABLE BATTERY
APC12100
Used in the Gallagher S50 Energizer.

APC12100 S50 Replacement Battery available for individual purchase

G59830 Fence and ground leads

S20

G357404

0.2

JOULES

- Multiwire distance ideal conditions: 14 acres/6 ha; 3 km/2 miles
- Stored energy (joules): 0.2
- Dimensions: 294 mm (w) × 304 mm (h)
11.6" (w) × 12" (h)
- Safe, powerful animal control designed for outdoor and portable use
- Can be mounted on a wall, T-Post, or sit on the ground
- Highly visible rotary dial for turning the unit Off and On
- Impact resistant plastic lens to protect the solar panel
- Easy to maintain and clean
- Maintenance-free rechargeable battery included
- Fence and ground leads (G59830)
- Replacement 12v battery (APC1250) sold separately



S17

G344404

0.17

JOULES

- Multiwire distance ideal conditions: 10 acres/0.8 ha; 1.5 km/1 mile
- Stored energy (joules): 0.17
- Dimensions: 295mm (w) × 305mm (h)
11.6" (w) × 12" (h)
- Large terminals enable correct grounding for best Energizer performance
- High-impact, UV-resistant plastic case for weatherproof, rust-proof, insect-proof outdoor use
- Maintenance-free rechargeable battery included
- Fits on top of steel t-post
- Automatic night save mode to extend battery life

Built in solar panel charges battery for consistent, reliable fence performance.



S17 RECHARGEABLE BATTERY 6V
A670
Used in the Gallagher S17 Energizer.

A670 S17 Replacement Battery available.
Fence and earth leads (G59800).

22 Grounding

Eight out of ten problems are due to improper grounding

Setting up a good grounding system is often overlooked but it's critical. It's how the power flows from the Energizer, to the fence, through the animal and back through the ground to the Energizer. Without good clean ground rods in sufficient size and number the ground connection doesn't work and the shock will not reach the animal.

For Wetter Regions

For use in greener regions where the fence can be simplified to an 'all live wire' system.

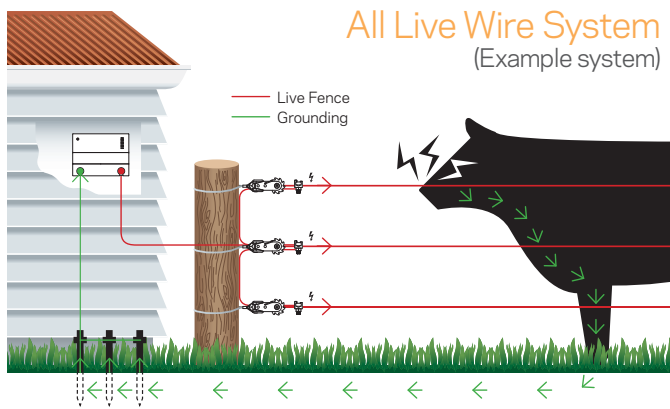

For Drier Regions

For use where the ground struggles to conduct enough power. A 'ground return system' is created where the live & ground wires on the fence create the shock when the animal touches them both at the same time.

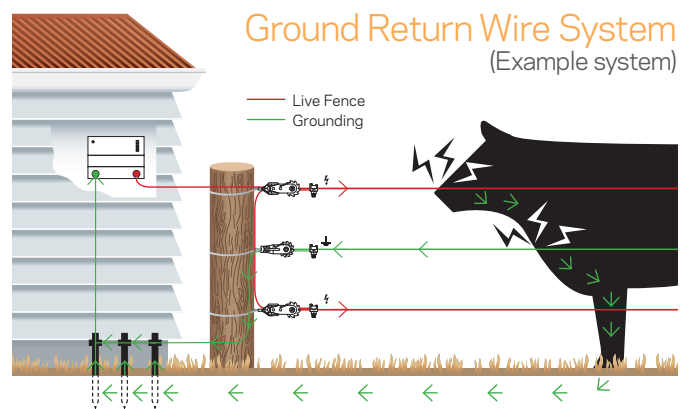

Handy Hint (3-3-2-1)

The rule for ground stakes when installing permanent fencing

3m (10') Between earth stakes/rods
3 Ground stakes/rods minimum*

2m (6') Minimum length of stakes/rods

1 Wire connecting all stakes to Energizer ground terminal

As a rule of thumb, use at least 3 ground stakes or the Energizer Stored Joules rating divided by 5.

GROUNDING

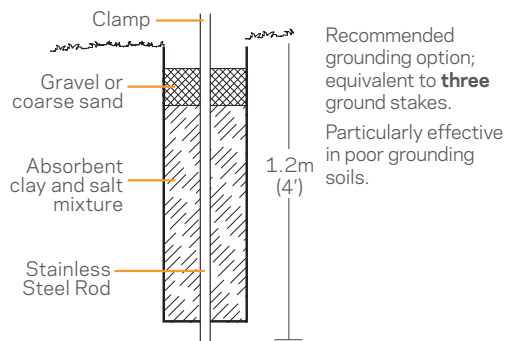

1.8 Meter Ground Rod
A351

1 Meter Ground Rod
A351A

HD Ground Rod Clamp
A352HD

Complete Ground Rod Kit
T87901

Complete 3-Ground Rods
T87900

- Three 1.8 meter (6') galvanised rods
- Heavy-duty clamps
- 15m (50') of 12 gauge galvanised wire

FENCE TESTERS



Fence Volt/Current Meter and Fault Finder (PREV: Smartfix Tester) G50905

Save hours checking fence lines for faults

- Large easy to read LCD display shows voltage & current
- Large arrows show direction of fault
- Auto On/Off when fence pulse detected



Energizer Remote and Fault Finder G50700

Quickly and easily locates fence faults. Once fault located turn the Energizer off remotely to allow safe and convenient fence repair. Rugged and reliable with a tough, water resistant casing.

Compatible with M1800i & M2800i



Fence Volt Meter G503014



Digital read out for accurate fence voltage measurement.

Fence Volt Indicator (PREV: Neon Tester) G501004



Simple indicator lights show approximate fence voltage levels.

FENCE MANAGEMENT TOOLS



Cut Out Switch G60733

A handy tool that allows a section of a permanent fence to be switched off for maintenance or fault finding.

- High quality phosphorous bronze contacts for long life & maximum effectiveness
- Highly visible on/off switch for status checking at a glance
- Full sealed, weatherproof & dirt resistant.



Live Fence Indicator G51100

Place permanently on your fence and simply look for the LED flash, for instant reassurance that the fence is working.

- No batteries required. Uses power from the fence (2000 kV or higher)
- Highly visible LED can be seen during day/ night (up to .5 mile at night)
- Long life - water and UV resistant
- Simply put ground stake in and clip on to fence wire or tape.



Knife Cut Out Switch G610



Alternative cut out switch option.

- Stainless steel contacts
- Easy to see open or closed status
- Use at gates and for easy location of fault finding
- Switch off a section of fence for maintenance and routine checks

SAFETY & PROTECTION



Flood Gate Controller G60400



Install on flood gates to prevent significant power loss when the water way is flooded.

Warning Sign G602304



A highly visible sign that warns that a fence is electrified. Required by law, to be used on boundaries and anywhere else public have access to a fence.

Lightning Diverter G64800



Gallagher recommends that all energizers be fitted with a lightning diverter to help protect from lightning damage. This diverter will withstand multiple lightning strikes and can be adjusted to fit any Energizer.

24 Electric Fencing Tools

FENCE TOOLS



Fencing Plier and Wire Cutter
G52200



Specifically designed for cutting, stripping and bending electric fence wire with minimum wire damage.

Strainer Handle
G69530



Springloaded ratchet strainer handle for quick adjustment of wire strainers (fits most varieties of ratchet strainers).

Ratchet Wire Tightening Tool
G645004



Rapid wire tightener handle with super smooth ratchet action, to be used with Gallagher in-line wire strainers (G64304).

Fence Tightener Tool
G644004



Permanent Fence Tightner Handle for Permanent Fence Tightener.

Wire Twisting Tool
G523004



Ideal for installing clips on posts and droppers.

Poly Wire Tensioner
AXLT8



Holds Poly Wire, 12mm Poly Tape and EquiBraid.

Screw In Tie Down
G61500 Screw In Tie Down (5 Pk)
G615014 Screw In Handle



Anchor fences to the ground in dips and hollows using this galvanised, long life screw in anchor. Requires Screw In Handle (G61501) to install.

Pay-Out Spinner
A308

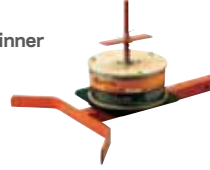

A necessity for building permanent fence. The adjustable break keeps wire from overwinding and it attaches to a 50mm (2") receiver.

H.D. Spinning Jenny
A309



Accommodates all standard wire sizes. Adjustable break keeps wire from overwinding.

Drill Chuck
G71300



Drill chuck for #G66604 Screw-In Ring Insulators.

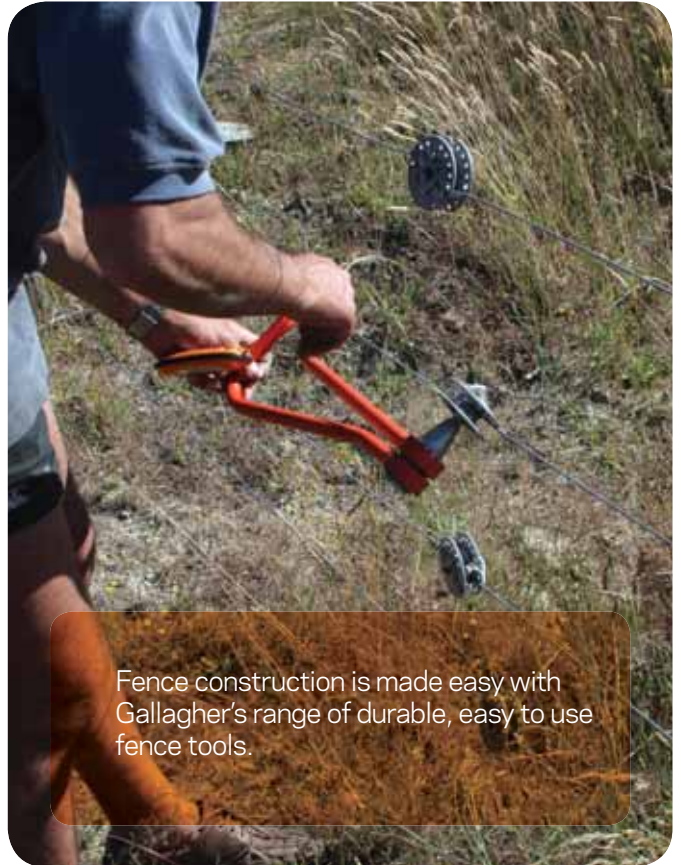

Fence construction is made easy with Gallagher's range of durable, easy to use fence tools.

GROUND BREAKING UV RESISTANT MATERIAL

Improves insulator life by
maintaining flexibility on the fence



STRENGTH



WARRANTY

END STRAIN INSULATORS AND STRAINERS



Insulator Super Strain

(PREV: High Strain Super)
White: G67812
Black: G67702



Strongest, long term end strain insulation for high tensile permanent electric fencing.



Also packs of 25: G67814 White; G67704 Black

High Strain Insulator Kit

(PREV: High Strain Termination Kit)
G61814



Simplest option for end strain insulation; comes with pre-attached wire rope. Fits up to 190.5 mm (7.5") posts. No wire tying or special tools needed.



Insulated Wire Strainer Kit

(PREV: Combination Strainer Termination Kit)
G618034



No wire tying, fast & simple. Includes all three end strain elements - insulator, strainer and steel rope. Simply slide over the post and you're done.



Wire Strainer

G79504



Ratchet style wire strainer. Can also be used in-line by threading through strainer. Tighten with G69530 ratchet handle.



Turbo Strain Insulator

G67914



Turbo Strain Insulator for EquiFence and Power Wire, super strong white polycarbonate



Rapid Wire Tightener

G64304
G64302 - 5 Pack



Fits over wire for mid-fence straining, increasing effectiveness of strain by pulling from both directions. Ideal for tightening existing fences or trellising wires.



Tie Down & Handle

G61500 Tie Down
G615014 Handle



Ensures a secure fence tie down. Tie down and handle sold separately



Polytube Strips

G614134 - White



584mm (23") Long protective strips for poly wire or braid. Available in white 25m (82') coil.



WOOD POST INSULATORS



Wood Post Claw Insulator

G67304 Black
G67224 - Brown
G67305 - 100pac
G67398 - 500pac



The most popular choice for permanent electric fencing using wood posts.



Wood Post Pinlock Insulator

G68704 - Black
G687144 - White



Used with high-tensile wire.



Wood Post Screw-in Ring Insulator

G66604 - Black



Angled slot allows quick securing and safe holding of wire. No need to create pilot hole first, simply screw into soft wood.



Wood Post Wide Jaw Claw Insulator

G67614 - White
G676044 - Black



Specifically for Equine Fence Wire or Striped Turbo Braid, the most popular choice for permanent equine fencing using wood posts.



Wood Post Heavy Duty Tape Insulator

G66910 - White



Soft rubber jaws lock 40mm (1.5") tape in place and prevent wear. Unique rubber pad eliminates tape wear.



Wood Post Corner Strain Tape Insulator

G67012 - White w/steel plate
G67090 - Steel plates sold separately



26 Steel & Fiberglass Post Insulators & Clamps

MULTI-PURPOSE INSULATOR



Multi-Purpose Insulator
G681034 - Black

Heavy Duty, snap-on plastic insulator designed for steel posts, but can be nailed to wooden posts or screwed to vinyl posts.



T-POST INSULATOR S

T-Post Universal Insulator
G682134 - White



Fits all T-Posts from 35.5mm (1.25") to 40mm (1.5"). This unique snap on design requires no tools to install. The wide jaw accommodates EquiFence and braid products.



T-Post 40mm (1.5") Tape
G654134 - White



Fits all T-Posts from 35.5mm (1.25" to 1.5") to 40mm. No tools are required to install. Specifically designed for 12.5mm-40mm (.5"-1.5") tape. Will accommodate EquiFence and braid products.



Steel Post Topper Insulator
G68513 - White



Safety and flexibility - add a single electric wire/tape/braid to the top of exiting posts using this protective cap.



IN LINE FIBERGLASS POST INSULATORS

Spring Grip Post Clip
A636



Clip for secure attachment to 9.5mm (.375") fiberglass post.



Screw-on Rod Insulator
G65514 - White

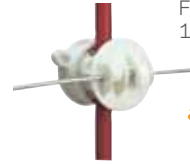

For round posts for 6.35mm to 15.85mm (.25" to .625") in diameter.



CLAMPS

Two options for clamping multiple HT wires in a secure electrical connection. Dedicated option for thicker wire/cable.

Joint Clamp
G603534 - 10 pk



L Joint Clamp

Wing nut:
G603934 - 10 pk

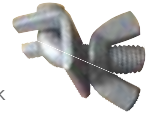

Claw Joint Clamp
G60315



Hex nut:
G60303 - 10 pk
G60308 - 500 pk



Benefits of Offset Fencing

Old fences can be made to last for many more years by simply attaching offset brackets and an electrified wire on one or both sides, even where fences have deteriorated so much that they need replacing.

New fences will last almost twice as long if they have electrified offset wires attached to them. Electrifying one or more wires in a conventional non-electric fence will prevent stock pushing through the fences.

Attach single offset wires at two thirds the height of the animal to be controlled. If sheep and cattle are to be in the same area, use two wires or a single offset attached at three quarters the height of the sheep.

Where old barbed wire is rusty and broken, remove the worst wires and tighten the others to prevent an ongoing problem of

them shorting out the offset wire. Old fence wires can also be connected in parallel and used as a ground return.

Mistakes often made with an offset fence

Offset fencing is simple, quick and inexpensive to erect. It can be used easily and effectively for salvaging old fence, protecting a new fence or for a number of temporary purposes.

An offset electric fence is inexpensive and simple, yet some people insist on trying to make it even less expensive. There are two common mistakes made with an offset fence and together they completely destroy its effectiveness.

The most common error is the use of soft wire for the fence wire and for the offset bracket. High tensile wire should always be used

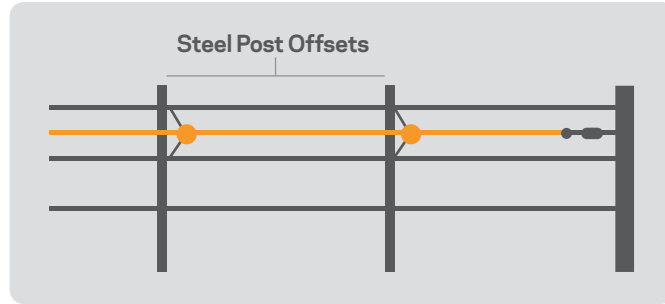
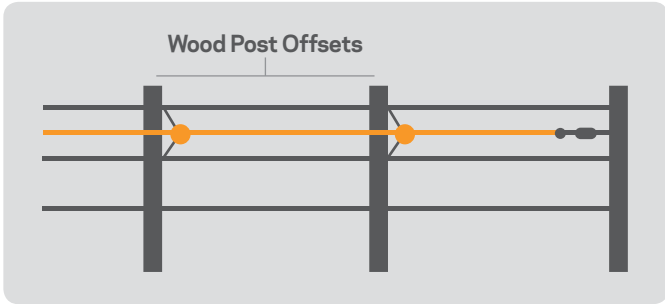

WIRE MOUNTED OFFSETS



Bracket Offset with Plastic Pinlock Insulator 300mm (12")

G659034 - Black, 10 pk
G659054 - Black, 50 pk
G665044 - Black Replacements

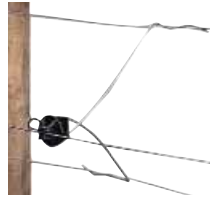

This offset will attach to any existing wire fence and comes pre-assembled.

Available for wood posts (G662054 & G66203).



for the fence wire and only spring steel wire for the offset brackets. The bracket must be able to spring back in place after impact or it will become entangled with the wire of the old fence and ground out.

The second most common mistake is the use of brackets that are too short, allowing the hot wire to remain too close to the fence it's attached to.

The placement/height of the hot wire is also very important. It should be attached at two thirds the height of the animal to be controlled. Two offset wires can and often are placed on the same fence. On one side a wire is placed at 762mm (30") to contain cattle and on the other side, a wire is placed at 203mm (8") to repel predators.

As simple as it is, offset fencing still must be viewed as a system. One shortcut or one sub-standard component can destroy the effectiveness of the fence.

PIGTAIL & WOOD POST OFFSETS



Popular option for adding an electric wire to existing wood post fences. Use side mount option for standard height or top mount for a higher top wire placement (e.g.: horses) and one or both sides of the post.

Pigtail Offset

G660214 - White



175mm (7")
Side or Top



Pigtail Offset

G660114



Pigtail Offset 400mm (16") galvanized spring steel with White UV plastic, drives into post.



Wooden Post 157mm (5") Offset Insulator

G617134 - White



The pinlock allows for easy fence construction and wire removal. The wide jaw accommodates EquiFence and braid products.



T-POST OFFSETS



T-Post 157mm (5") Offset Insulator

G650134 - White



Extra locking tab enables offset to fit all T-Posts. The pinlock allows for easy construction and wire removal. The wide jaw accommodates EquiFence and braid products.



Ensure optimum power to all parts of the fence

Lead out describes the cable and wire that carries the power from the Energizer to the middle of your fence system. Much like your farm water system, ensure optimum power distribution to all areas of your fence by choosing the most conductive cable/wire (biggest feeder pipe) relevant to your fence system.

DOUBLE INSULATED CABLE: Energizer to the fence



Voltage at start of fence 8kV

Insulated Cable

G609024 50m (165')
16 Gauge



This double insulated cable has a resistance of 160 Ohms/km.

Double Insulated Hard Cable

G627034 100m (330') Black
G62702 50m (165') Black
G627014 19m (65') Black



Made of 12.5 gauge steel and is ideal for standard leadouts and undergate cabling.

High Conductive Cable (PREV: XL)

G62793 100m (330')



This 12.5 gauge aluminium coated cable is ideal for long distances underground, through buildings or where there are numerous gateways in the leadout system. Three times the conductivity of 12.5 gauge galvanised wire.

WIRE ACCESSORIES:



Vine-line Wire Connector

T61003



Line connector used for splicing Power Wire

ELECTRIC FENCE WIRE: Fence to middle of system



High-Tensile Wire (PowerPlus)

A303 805m (2,641')
T90102 610m (2,000')



Engineered and manufactured especially for permanent fencing. This 12.5 gauge wire is much stronger than standard fence wire and class III galvanised for longer life - 1,70,000 PSI.

Aluminium Wire

AXL17250 17 Gauge; 76m (250')
AXL171320 17 Gauge; 402m (1,320')
AXL141320 14 Gauge; 402m (1,320')
AXL142640 14 Gauge; 804m (2,637')
AXL121320 12.5 Gauge; 402m (1,320')
AXL124000 12.5 Gauge; 1219m (4,000')



Ideal for long leadout with very high powered Energizers. Never rusts; a permanent solution even in harsh environments. Conducts electricity four times better than steel wire.

Easy to re-spool and ideal for controlled grazing.

1/3 Weight of steel

EQUINE FENCE WIRE



Equine Fence Wire

G912064

- Ideal for horse fencing - safe and effective
- Best for permanent fence - 12.5 g core
- Med tensile galvanised wire
- 10 Year warranty



Using Insulated & Underground Cable

Leadout Cable or Double Insulated Cable should be used in buildings, under gateways and where soil could corrode exposed galvanised wire.

Undergate cables should not be used for long leadouts or for long distances underground, because the 16 gauge galvanised wire will cause resistance to the flow of the current. This is not so important on small properties, but where long distances of fencing are to be erected use 12.5 gauge Leadout Cable or High Conductive Cable.

Never use household electrical cable; it is made for a maximum of 440 volts and for inside work only.

Never use copper wire undergate cable because electrolysis problems occur where it is joined to galvanised fencing wire.



Conductor Selection Chart

			VOLTAGE AT BEGINNING OF FENCE	5 KM FENCE	1 KM FENCE	RESISTANCE (Ohms/km)	MIXED METALS*	INTERCONNECT*	
Braid, Wire, Rope	A) Turbo Braid G62174 200m/656' White G62176 400m/1312' White		<ul style="list-style-type: none"> 9 Mixed metal strands Most user-friendly for horse fencing - visible and safe Best suited for any distance temp or permanent fence 	8kV	7kV	6.3kV	155	▪	
	B) Turbo Wire G62054 200m/656' G620564 400m/1312' G62089 800m/2,625'		<ul style="list-style-type: none"> 9 Mixed metals Best suited to distances more than 1/4 mile, where extreme power is required 40 times more conductive than standard Poly Wire 	8kV	7kV	6.3kV	209	▪	
	C) Poly Wire G62004 200m/656' White G620300 500m/1,64' White G620664 400m/1312' Org		<ul style="list-style-type: none"> 5 Stainless steel strands Best suited for distances under 1/4 mile 	8kV	1.1kV	0.6kV	10,000		
12.5mm (.5") Tape	D) 12mm Turbo Tape G62354 200m/656' q 400m/1312'		<ul style="list-style-type: none"> Mixed metals 30x's more conductive Best suited for distances greater than 1/4 mile 	8kV	6.4kV	5.3kV	400	▪	▪
	E) 12mm Poly Tape G62304 200m/656' White G62314 200m/656' Orange		<ul style="list-style-type: none"> 5 Mixed metal strands for good conductivity 	8kV	0.84kV	0.45kV	13,600		
	F) 12mm Turbo Tape G62364 200m/656' Stripe G62366 400m/1312' Stripe		<ul style="list-style-type: none"> 15 mixed strands for ultra high conductivity Reinforced edges for longer life & open weave for low wind resistance 	8kV	6.4kV	5.4kV	230	▪	▪
40mm (1.5")	G) 38mm Turbo Tape G624544 200m/656'		<ul style="list-style-type: none"> 15 mixed strands for ultra high conductivity Reinforced edges for longer life & open weave for low wind resistance 	8kV	6.4kV	5.4kV	250	▪	▪
Rope	Turbo EquiRope G62254 200m/656' G62257 500m/1,640'		<ul style="list-style-type: none"> 9 Super conductive alloy strands 	8kV	6.7kV	5.4kV	250	▪	▪

30 Reels

Gallagher has a wide range of reels, portable posts and fence wires to make portable fencing easy and effective. Discover the best choice below to meet your needs.

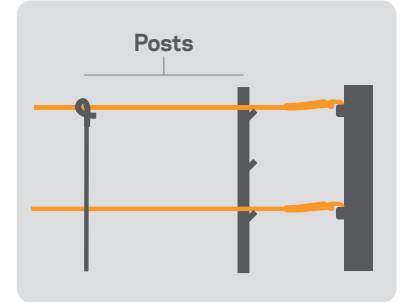
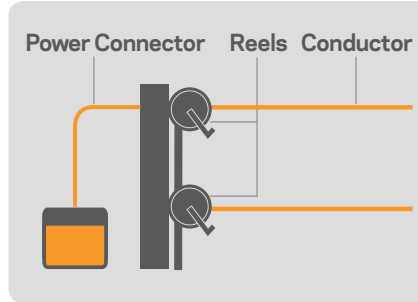

GEARED REELS

STANDARD GEARED REEL G61150

- G61156 (Pre-wound 400m (1,312') White Turbo Wire)
- G61158 (Pre-wound 200m (656') Striped Turbo Tape)
- G611604 (Pre-wound 400m (1,312') Orange Turbo Wire)

Larger capacity for bigger paddocks
Approx. capacity: 1.2km (.31 mile) Poly Wire, .9 km (.25 mile) Turbo Wire or .2km (.125mile) Tape.

Reels can be attached to galvanised Porta Reel Post (G63300)



MAXI GEARED REEL G631504

Most popular option for fast winding (2.7:1) on standard length portable fences.

Approx. capacity: .5 km (.75 mile) Poly Wire, .25km (.62 mile) Turbo Wire or .125km (.25 mile) Tape.



NON GEARED REELS

Lightweight & strong, for use on shorter, less frequently moved portable fences.

MEDIUM PORTA REEL

G61100 Reel does not come prewound

Approx. capacity: .5km (.124 mile) Poly Wire, 4km Turbo (.09 mile) Wire or .2km Tape (.05 mile)



REEL ACCESSORIES

Reel Stand 1m (3) 1-3 reels G63300



Rust resistant steel, tread-in post for holding up to 3 reels for strip grazing and temporary fencing. Includes chain for securing to a post.

Medium Reel Guide Replacement G61200



For tangle free operation.

Econo Reel

G61600 (Not pre-wound)

.5 km (.33 mile) Poly Wire capacity or .4km (.25 mile) Turbo Wire capacity.

G616014 Prewound with 500m (1,640') White Poly Wire



POWER CONNECTORS

UV resistant leads connect a portable fence to a permanent fence.

Multi Reel Lead Connector G63450



Single Reel Lead Connector G634004



Tumblewheel

G63800

Enables you to quickly and easily roll a fence line to a new position. The Tumblewheel's unique center hub maintains power while the fence is being moved. It can also be used on flat, very hard and frozen ground. The legs remain live except for two legs that are on the ground.

Where several breaks are needed in one paddock, Tumblewheels are ideal for quick and efficient rationing of grass.

This fence consists of a number of electrified 'wheels' spaced across the pasture. The wheels are held upright with the tension of the single line fence which passes through the center.

When one or both ends of the fence is moved, the wheels roll along. When you stop, the fence stops.

Each Tumblewheel can be easily assembled or dismantled for storage.



POSTS (All heights are from the foot)



Pigtail Standards – the most popular option for dairy & beef cattle

Standard Pigtail T642134

Ideal for softer ground, welded foot design reduces tangling.



Fiberglass Rod Post A635 - White

10 x 1219mm (.375" x 48')
Made of highly visible white fiberglass.

Use with A636 Quick Clip.



Multiwire Treadins – multiple lug positions for many animal types

Treadin Plastic Double Foot G72413

This very sturdy and durable plastic post is 990mm (39") in length with 9 numbered lugs designed for virtually all animal types.



Steel Multiwire Treadin

T64253 Standard
G64263 Tall

UV white plastic coated

Ring Top Post G672313

With a head that will not wear through, a super strong foot plate that will not bend under pressure and a sleek design that significantly reduces tangling, the Ring Top Post combines more strength with less frustration.



20mm (7/8") Fiberglass Fence Post

Use where a permanent fence post is required. Often used in feedlots or near buildings where animals may be pushed into the fence. These posts are predrilled every 50mm (2") for convenient wire spacings with exception of bottom 475mm (18") on AFRP60, AFRP66 and AFRP72.

25 Year UV protection warranty.

AFRP48 - 1219mm/48" AFRP66 - 1676mm/66"
AFRP60 - 1524mm/60" AFRP72 - 1828mm/72"



Fiberglass Post Clips G704004

Made of galvanised, mild steel. Fast and easy design to use.



Fiberglass Stay Clips G70200

Made of galvanised mild steel. The tight tie prevents slipping.



32 Gate Kits and Gate Accessories

How to compare under-gate cable

Choosing higher conductive under gate cable will ensure maximum power transfer between the two fence sections. Look for the lowest resistance rating per mile.

Soft cable is easier to strip while hard cable offers the best protection in the ground (note Gallagher recommends cable be installed through pipe for ultimate protection, especially in rocky ground).

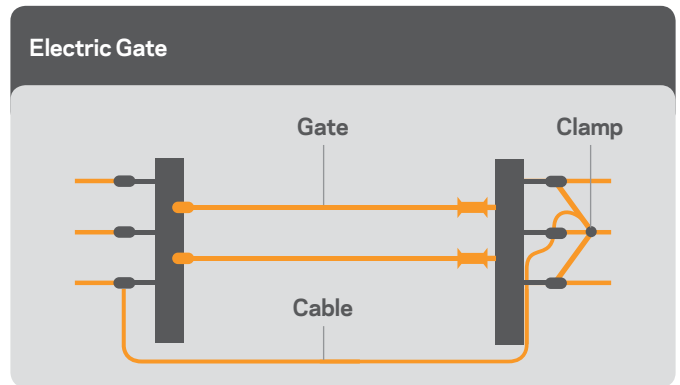

ELECTRIC GATE HANDLES

Heavy Duty Gate Handle
G639304



Flat hook for maximum electrification and extra safe handle which pulls out on impact. Heavy-duty tension spring.

Gate Handle
G691104 (White)



Insulated gate handle, white plastic with galvanized spring & hook.

Gate Handle
G68910 (White)



Large shield on handle to protect from shocks.

Insul-Grip
G606304



Insulated hook for quick and secure attachment of portable fences.

ELECTRIC GATE ACCESSORIES

Gate Anchor
G64610



Robust insulator screws directly into wooden post. Non-rust galvanized plate to ensure long life.

Wood Post 3-Way Gate Anchor
G64912



Super strong live anchor for up to three gates coming to a junction. Ideal for use in gateway systems at the intersection of multiple paddocks.

SINGLE STRAND KITS

All Gallagher gate kits include a high visibility flag.

Ultra White Spring Gate
G64010



Highly visible electrified gate with insulated gate handle. Gate width is up to 5m/16.5'.

Kit includes: insulator 3-way gate anchor, gate handle and all metal galvanized and powder coated spring.

Bungy Gate
5.5-11m/
18-36'
G64051



Pre-assembled gate - bungee cord stretches to twice its length and is ideal for on/ off laneways. Made with stainless steel strands for maximum life and electrification.

Bunge Gate
3.5-7m/11.5-23'
G640504



Highly visible shock cord.

Kit includes: insulator 3-way gate anchor, gate handle and bungee cord with UV stabilizer.

Electric Galvanised Spring Gate
G64000



Pre-assembled spring gate suited for 3-5m/10-16' wide gateways. Longer life design as spring doesn't touch the ground when gate is open.

High visibility or standard options available.

Gate Latch with Gravity Ring
F0201



High quality electro galvanizing corrosion protection. Adaptable to metal or wood gates.

One-Hand Gate Latch
F0202U



Includes two staples and a 355mm/14" chain that is easy to attach and can be padlocked. Made from silver zinc passivate material.

Soft Touch Gate Handle

G69603 & G69703

Premium gate handle with comfortable rubber grip handle, and unique internal overstretch protection. Rope/bungy and tape versions available.



Two attachment options: die cast buckle for Tape; steel loop for Rope/Bungy Cord/Braid/Wire

Curved design reduces impact damage eg: if stood on

Unique comfortable rubber grip

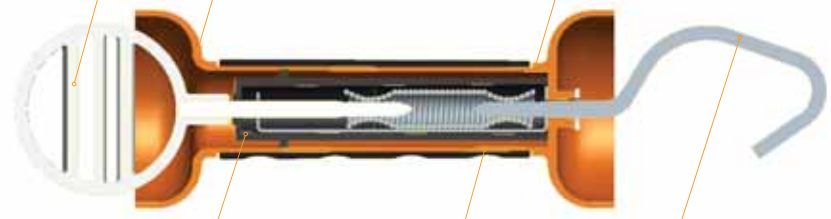

Steel restrainer plate prevents the spring from overstretching

UV resistant materials

Hook straightens under extreme animal tension to prevent stock injury

OTHER GATE KIT OPTIONS



Multi Strand Electric Tape Gate

G71802 2 Strand 8m/26' (cattle)
G71804 4 Strand 6m/20' (sheep)

A low cost, all-in-one permanent electrified gate option with multiple live strands, for practically any width gateway. It's easy to setup and use - open/ close with one hand.



- Two or four strand option: Two strand for cattle and four strand for sheep
- Extendable tape lengths to fit desired gate width. Holds 12.5mm/.5" tape (included) or 40mm/1.5" tape (clips included)
- Quick and easy to install. Simply attach to existing gate posts using supplied mounting hardware
- Simple, safe electrification as a live hook provides power to gate when closed and disconnects power when opened
- Easy to repair. If one strand breaks, simply change out the tape



34 Netting & Woven Wire



ElectroNet

A201000

- 889mm x 50m (35"x164') Roll.
- 8 conductive horizontal wires.
- White plastic vertical struts every 304mm (12").
- Roll complete with all posts, just unfold and set the posts.
- Impenetrable mesh fencing for sheep, goats, coyotes and dogs.

Poultry Net

A207015

- 1219mm (48") high prefab electrical fence with 12 horizontal lines.
- 50m (164')
- 12.7mm (.5") diameter white PVC posts every 2.4meters (8').
- Double 152mm (6") spikes on each post for support.



Electra-Lock

Electrifiable Woven Wire Permanent Hi-Tensile Fence

A43024660 4 Wire 762mm (30") High
A54024660 5 Wire 1016mm (40") High
AELD1000 Electra-Lock Wire Dispenser
AELS100 Stretcher Bar

The cost savings are half of standard barbed wire construction.

This electrifiable woven wire fence comes in either 4 or 5 strands of hi-tensile, class 3 galvanised wire in 201m (660') rolls. Specially designed lock knot holds vertical stays in place.

Installs with same corner and gate posts as standard barbed wire.

Recommended post spacing, depending upon terrain, is every 15m (50') for 1 fiberglass posts, 1m for wood posts and 7.6m (25') for steel t-posts.





Smart Fence 2 G70000

A quicker and easier all in one instant fence system, the Smart Fence redefines portable fencing.

- Instant portable fence system
- Easy to carry and store away
- Highly effective safe animal control
- Installs in just five minutes and is quickly dismantled
- System includes 4 wires, 10 posts, 100m (325') length
- Compatible with Gallagher Energizers - Energizer is not included



Garden & Backyard Protection Kit

A600

This kit is an easy do-it-yourself electric fence that fences a 15.24m x 15.24m (50'x50') area with three adjustable wires. It is a perfect fit for a residential consumer that is interested in an easy and affordable way to protect their garden, landscape or new plantings. Essentially tool-free and can be installed in 1 hour or less. Energizer operates on common 'D' cell batteries - no electric outlet or extension cord is used.

- 8 - 1.21m x 9.5mm (48"x3/8") Fiberglass Posts
- 2 Bags 9.5mm (3/8") Clips
- 1 Poly Wire 200m (656')
- 1 - 1m (3') Ground Rod
- 1 B10 Energizer



Gallagher Weighing and Electronic Identification Systems

Gallagher Weighing and Electronic Identification systems include a full range of leading edge, robust and simple to use animal weighing, data collection and electronic identification (EID) systems. Gallagher offers you a complete system to help you monitor and maximize performance of your animals, and extract more profit from your operation.



The TSi 2 weighs and records livestock information



Gallagher 810 is an advanced EID compatible weigh data collector



Scanning sheep ear tags with a HR3

The Gallagher range of readers, weigh scales, loadbars and accessories are fully compatible, offering a wide range of capability and a system that will match your operation's requirements. Gallagher weighing and EID products are distinguished in the market by their advanced features and tough, durable, simple design that makes them easy to operate. Recognised by the 'Gallagher Technology' icon, high performance products incorporate the latest technological advances from Gallagher.

Weighing and Data Collection

The Gallagher SmartReader range includes permanent and portable tag reading options, all with full ISO tag compatibility. The SmartReader BR or R series permanent EID reader is fixed in place for hands free reading and is the best choice for animal identification at a fixed location, such as a alleyway or chute.

Electronic Identification

The SmartReader HR3, HR4 & HR5 are light and easy to use - perfect for portable applications for use at different sites.

Gallagher weigh scale indicators range from the basic W210 model for entry level automatic weighing, up to the W810 model for advanced EID compatible weighing

and data collection. The TSi is the latest in Gallagher weighing technology, a unique touch screen weigh scale, computer and animal management system which allows you to instantly record and access data on individual animals and groups of animals.

TSi 2

G01901

FASTER PROCESSOR MORE MEMORY IMPROVED SCREEN

An animal weighing and data collection system for improved livestock management and performance. The TSi 2 provides immediate access to detailed animal information, anywhere, at any time - in the sale barn, the office or on the ranch.

Intuitive software - Supplied with award-winning Animal Performance Software (APS Professional), for analysis and reporting to provide virtually any information you need.

Rugged exterior - Tough ranch/farm ready design for all-weather use.

Rapid, accurate, automatic weight capture.

Customizable sessions - Easily customize weighing and data recording sessions to collect specific traits, activities, notes etc.

Simple recording and retrieval - Collection of comprehensive data and retrieval of information at the touch of a button, while in the yard.

Exceptional connectivity - Bluetooth wireless connection and full integration with loadbars, EID readers, auto drafters and other management software.

Easily transfer data - WiFi enabled to allow upload of data directly to web and share with third parties.

Significant memory capacity - Entire life history of all animals stored for on-site viewing - over one million animal records can be stored.

Comprehensive drafting - Draft by weight, EID number or custom defined rules.

Touch screen - Full color outdoor readable touch screen with large touch buttons.

Bluetooth Communication and WiFi

Internal Battery

Audio Out

Loudspeaker

Power

USB Ports

Loadbar Connectors

RS232 Ports x 2



ANIMAL PERFORMANCE SOFTWARE (APS PROFESSIONAL INCLUDED)
Analyze data and upload in three easy steps.

Comes with carry case, memory stick and mounting bracket.



38 Selection Chart

Find the correct weighing set up that best suits your needs using the table below.

1. Select the animal that you want to weigh.
2. Then select your current or preferred method of containment to find the products you'll need.

		Animal Type			
		Sheep	Dairy	Calves	Cattle
Method of containment	CHUTE	Alleyway Loadbars (G06000)	Heavy Duty Weigh Feet (G05420) Super Heavy Duty Loadbars (G06400) Heavy Duty Loadbars (G06300)	Alleyway Loadbars (G06000)	Heavy Duty Weigh Feet (G05420) Super Heavy Duty Loadbars (G06400) Heavy Duty Loadbars (G06300)
	PLATFORM	Alleyway Loadbars (G06000)	Alleyway Loadbars (G06000) Aluminium Platform (G05900)	Alleyway Loadbars (G06000) Aluminium Platform (G05900)	Alleyway Loadbars (G06000) Aluminium Platform (G05900)

ACCESSORIES



6M (20') Loadbar Extension Cables

- 1995 kg (4,400 lbs) Loadbar (G05000)
- 3500/4490 kg (7,716/9,900 lbs) Loadbar (G05100)
- 6m (20') long, tough polyurethane loadbar cables
- Fitted with high quality, moisture proof connectors



4.5M (15') Double Antenna Cables

- Double antenna cables designed to link two panels to one reader.
- G05606 - Use with small and large antenna panels.



Suspension Load Cells



- 250 kg (550 lbs) G05500
- 500kg (1,100 lbs) G05501
- Spring wire protected cable
- Fitted with high quality, moisture proof connectors

SCALE ACCESSORIES



Scale Bracket

4G2209

110V Adaptor (for W810, W610, W210)

2M1695



Features

TSi 2

W810

W610

W210

OPERATION & DATA COLLECTION

Manual and automatic weight locking options	▪	▪	▪	▪
Assign visual tag against weight and EID number	▪	▪	▪	
Calculates average daily weight gain and carcass weight	▪	▪	▪	
Cross reference table capacity	1,000,000	21,000	12,000	
Max number of weigh records	1,000,000	60,000	12,000	
Individual animal notes and weight recorded	▪	▪	▪	
Condition score recording	▪	▪	▪	
Multiple custom trait definitions (i.e. blood groups, genetics etc.) to collect and edit data	▪	▪		
Review full animal history in the yard	▪			
Manage treatments and associated withholding periods	▪			
View animal pedigree information in graphical family tree	▪			
Create custom data fields and calculations	▪			

DRAFTING

Liveweight drafting	▪	▪	▪	
On screen drafting statistics recorded	▪	▪	▪	
Automatic drafter interface	9-way	9-way	5-way	
Drafting by electronic ID number	9-way	9-way		
Draft based on Average Daily Gain (ADG) or custom calculations	▪			

CONNECTIVITY

Automatic load bar recognition & calibration	▪	▪	▪	▪
Computer and printer interface	▪	▪	▪	
Bluetooth connection to EID readers and drafters	▪	▪		
WiFi connectivity	▪	▪		

SOFTWARE

Compatible with Gallagher Animal Data Transfer Android App		▪	▪	
Animal Performance Software (APS) Standard for basic data analysis	▪	▪	▪	
Animal Performance Software (APS) Professional for advanced stock analysis	▪			

Note: You may purchase APS Pro for W810 & W610.

40 Weighing, Data Collectors & Platforms

A Gallagher Weigh Scale provides producers with an innovative weighing system that is not only tough, reliable and accurate but also very simple to use.

W810

G01805

Rapid, automatic, accurate weight capture.

Super long run time internal rechargeable battery with charge indicator and low voltage shutdown. (Mains battery charger & 12 volt battery leads supplied).

Quick glance graphics screen to show weighing statistics and individual animal data entry (W810 v2 & W610 v2).

Smooth action rotary switch providing easy access to multiple weighing modes.

Large and easy to read display screen. W610 and W810 screens are also backlit for poorly lighted areas.

Simple operation with large push buttons.

Simple connection - W810 has full Bluetooth wireless connection. W610 has communication ports for connection to computer, EID readers (with Bluetooth Adaptor G03203) and drafters.

Large easy to use push button keyboard for alphanumeric data entry (W810 & W610).

Extra protection and transportation - Tough shock and waterproof case.



FREE ANIMAL DATA TRANSFER APP
Transfer animal data using your W810 or W610 and Android Smartphone. Available FREE from Google Play.



ANIMAL PERFORMANCE SOFTWARE (APS STANDARD INCLUDED)
Analyse data and upload data in three easy steps.

W810

G01805 (pictured above)

Advanced EID compatible weigh scale and data collector. New model combines super fast weight locking with outstanding accuracy.

W610

G01605

Entry level EID compatible weigh scale. New model combines super fast weight locking with outstanding accuracy.

W210

G0120504

Entry level automatic weigh scale.

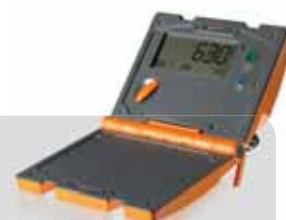

Weigh Scale Indicator W610

G01605

ALL THE WEIGH SCALE INDICATOR W210
FEATURES PLUS:



ENTRY LEVEL EID COMPATIBLE SCALE

- Second LCD screen for data display and statistics
- View weight gain, graphical displays and other options on graphics screen
- Direct interface to EID tag reader
- QWERTY keyboard for alphanumeric IDs
- Supplied with APS PC software for easy download of records from, and upload of records to, the Weigh Scale Indicator
- Calculates average daily weight gain and carcass weight
- Assigns visual tag number against EID tag number
- Assign up to 15 digit visual tag number against weight records and EID number
- Animal notes stored with each weighing record
- Draft statistics displayed while weighing for animal audit
- Draft category stored with animal record for later analysis
- Automated drafter interface to control 5-way drafting
- Stores 15 digit tag numbers plus 2 digit condition scores
- 2 communication ports for connection to computer and peripheral devices, such as animal drafters and EID tag readers
- Stores 12,000 animals and 12,000 records

W210 Package

AG210

Entry level weighing system for producers.
Get it all in one package deal!

Includes: W210,
Alleyway Loadbars,
and Platform.



Weigh Scale Indicator W210

G012504



ENTRY LEVEL AUTOMATIC WEIGH SCALE

- Tough, shock and waterproof case
- Large labelled push buttons
- Large rotary dial
- Three weighing modes for quick and easy weighing: auto, manual and fine
- Compatible with most loadbars
- Internal rechargeable battery
- Large, easy to read display
- Simple operation



42 Loadbars, Readers & Accessories

Alleyway Loadbars

G06000



- 1,995 kg (4,400 lbs) weighing capacity in 584mm (23") length
- Rugged galvanized steel chassis
- Bottom feet-mounting holes extend beyond top covers for ease of bolting down
- Slotted top-mounting holes fit most sizes of platforms
- 6M (19.6') long, tough polyurethane loadbar cables with spring wire protection
- Fitted with high quality, moisture proof connectors
- Fully water resistant
- No rubber mounts
- 2 Year warranty

Heavy Duty Loadbars

G06300



- 3,492 kg (7,700 lbs) weighing capacity in 990mm (39") length
- High capacity load cells are able to withstand large shock loads
- Heavy galvanized steel chassis construction to withstand the harshest environments
- Bottom feet-mounting holes extend beyond top covers for ease of bolting down
- 6M (19.6') tough polyurethane loadbar cables with spring wire protection
- Fitted with high quality, moisture proof connectors
- Fully water resistant
- No rubber mounts
- Designed for a manual squeeze chute
- 2 Year warranty

Super Heavy Duty Loadbars

G06400



- All of the features of the Heavy Duty Loadbars but have 4,490 kg (9,900 lbs) weighing capacity in 990mm (39.3") length. These loadbars are made from galvanized steel and are powder coated
- Designed for manual chute or hydraulic chute
- 2 Year warranty

Heavy Duty Weigh Feet Kit

G05420



- Four tough, stainless steel weigh feet for easy mounting under cattle chute and custom platforms
- 5,000 kg (11,000 lbs) weighing capacity
- Fast and easy loadcell replacement without major lifting
- High accuracy corner to corner performance for demanding weighing requirements
- Extra loadcell supplied in kit for easy replacement and no down-time
- Designed for manual chute or hydraulic chute
- Compatible only with 610, 810 and TSi

Aluminium Platform

G05900

- A high-strength platform designed to fit Gallagher 1995 kg alleyway loadbars and most other branded loadbars
- Combine strength and portability to reduce the time and hassle involved in setting up weighing sessions
- Dimensions: 2197mm (86.5") long, 622mm (24.5") wide; Platform weighs 10 kg (49 lbs)



Smart Reader Electronic Controllers



G03111

- HDX and FDX-B, ISO and NAIT Tag compatible
- No antenna tuning required
- Can be used with either antenna panel below

BR Series Electronic Controller

- Battery powered electronic controller for livestock identification
- Internal rechargeable battery
- Easy to read battery charge indicator
- Internal memory stores 20,000 tags
- Tag counter display screen records animals scanned
- Download stored records to computer
- Replacement battery A728



G03113

R Series Electronic Controller

- Electronic controller for livestock identification
- Requires external 12 volt power source (not included)

Smart Reader Panel Antennas

- Suitable for walk past identification applications
- HDX and FDX-B ISO compliant panel
- Waterproof antenna panel
- Mounting hardware supplied
- Can be used with either electronic controller above



G031424



G03121



Cattle automatically identified by BR Series as they enter the handler.



BR Series automatically provides ID number to Weigh Scale Indicator enabling accurate collection of individual sheep weights.



Integrated BR Series and Weigh Scale Indicator system on cattle handler.

HR5 Hand Held Tag Reader

G03303

With its large color screen and alpha numeric keypad, the HR5 Hand Held EID Tag Reader is the most powerful portable data collection and editing platform available providing flexibility right there in the yard.

Producers can record, edit and customize data against EID records immediately without needing to set it up in the office first.



ANIMAL PERFORMANCE SOFTWARE (APS STANDARD INCLUDED)

Analyse data and upload in three easy steps.



FREE ANIMAL DATA TRANSFER APP

Transfer animal data using your Gallagher Hand Held EID Tag Reader and Android Smartphone. Available FREE from Google Play.

Key activities of the HR5:

Easily read visual and EID tag numbers



Large display clearly shows visual ID and EID tag numbers to confirm the correct animal's information is being collected

Collect data, not just EID numbers



Choose multiple traits to record against each animal such as breed, sex, condition score and pregnancy status

Sort on the go



Sort group name is highlighted on screen for easy reference with optional group colors

View animal history



View past traits, activities and life data recorded against an animal

Record Visual ID's



- Visual ID's can be added on the go, and used to identify and record information against an animal e.g. replacing a lost EID tag number
- Record data against visual ID if animal EID tag cannot be read

Link mothers to their offspring



- Automatically link mothers with their newborns
- Add birthing details and data such as sex, birthing ease and fate

Versatile data entry



- Numeric, text, date and pick-list type traits can be entered e.g. an observation using the free text entry field
- Animal notes can be set to appear as an alert when the animal is next scanned

Add and edit session names



- Personalize session names (e.g. Week 13 Lambs, Pen 12 Angus, Hereford Cows)
- Make it easy to identify sessions once uploaded to APS software

46 Hand Held Readers & Data Collectors

HR4 Hand Held Tag Reader

G03302

Easy recording of pre-defined animal data against EID tag numbers.

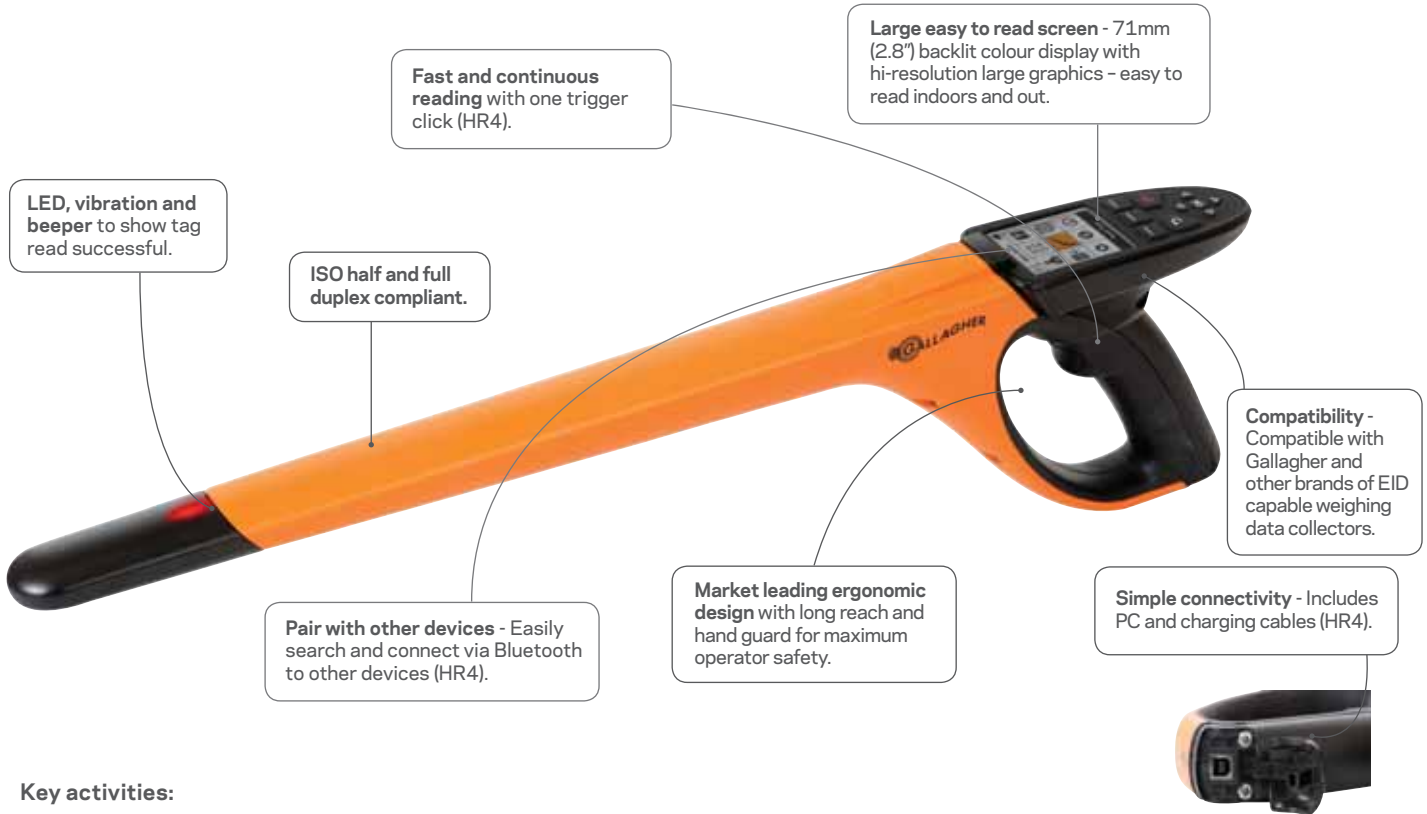

Key activities:

Easily read visual and EID tag numbers



Large display clearly shows visual ID and EID tag numbers to confirm the correct animal's information is being collected.

Collect data, not just EID numbers



Choose multiple traits to record against each animal such as breed, sex, condition score and pregnancy status.

Sort on the go



Sort group name is highlighted on screen for easy reference with optional group colors.

View animal history



View past traits, activities and life data recorded against an animal.

HR3 Hand Held Tag Reader



G03301

Wireless EID recording with the same ergonomic design as the HR4 and HR5.

- Create new sessions on reader to group tag reads from different pens of animals
- Use screen to see number of tags in current session, total number of tag numbers stored in memory, unique EID number of last tag read and battery charge level



Features

	HR5	HR4	HR3
OPERATION			
Memory capacity	100,000	100,000	5,000
Large 71mm colour LCD backlit screen	▪	▪	
Re-configure settings on the Reader itself	▪	▪	
Bluetooth	▪	▪	▪
USB connectivity	▪	▪	
Powered by internal rechargeable battery	▪	▪	▪
Bluetooth Adaptor for non-Bluetooth EID compatible weigh scales	Sold separately		Included
Comfortable ergonomic, soft grip handle	▪	▪	▪
Rugged carry case	▪	▪	▪
VISUAL ID AND EID TAG MANAGEMENT			
Record replacement of animal EID tag	▪		
Edit visual ID on device	▪		
Look up animal from visual ID only	▪		
Visual ID cross reference table	▪	▪	
Continuous tag read mode	▪	▪	
Vibration, audible feedback and LED confirmation of tag read	▪	▪	▪
SESSION AND DRAFTING ACTIVITY			
Numeric, free text and date data entry	▪		
Enter animal notes	▪		
Session name and notes entry	▪		
Link Mother to off-spring	▪		
Record alerts, as a reminder, when animal is next scanned	▪	▪	
Pick-list data entry	▪	▪	
View animal history by trait, life data or activity	▪	▪	
Assign sort color	▪	▪	
Distinction between traits, life data and activities	▪	▪	
Date and time stamp on all records	▪	▪	
Number of animal traits per session	9	3	
 FREE Android App for easy transfer of animal data	▪	▪	▪
 Animal Performance Software (APS Standard) for PC	▪	▪	▪



Scanning sheep ear tags with an HR3.



Use pre-defined 'lists' with the HR4 to record traits such as breed or sex and sort into color coded draft groups.



The HR5 screen clearly displays the visual ID and count of animals in the session.

48 Software

Extract more profit from your farm with Gallagher Animal Performance Software (APS) and make animal data transfer easy with the free Gallagher Animal Data Transfer App.

Animal Performance Software (APS) Professional

APS Professional is a comprehensive stock analysis tool with powerful filtering and customized reporting capability to give you virtually any information you need on individual animals or custom groups of animals.

APS Professional includes all of the features of APS Standard plus the following:

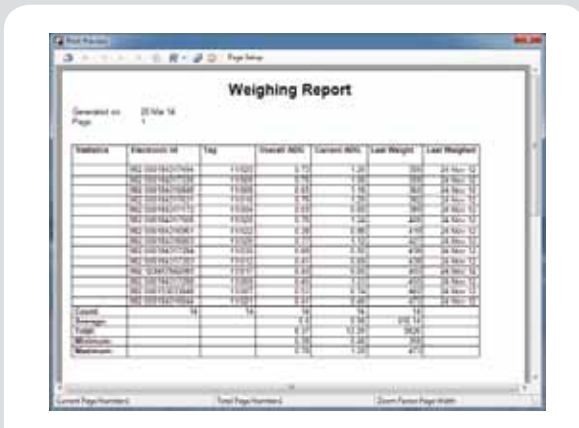

Create custom reports - e.g. grazing, weaning or pregnancy scan summaries.

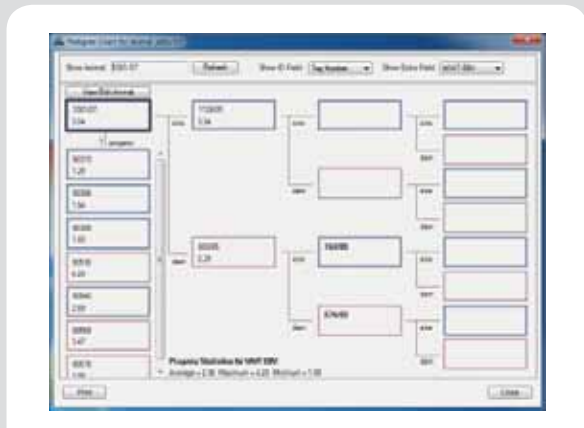

Review animal pedigree information in a family tree and related genetic performance.

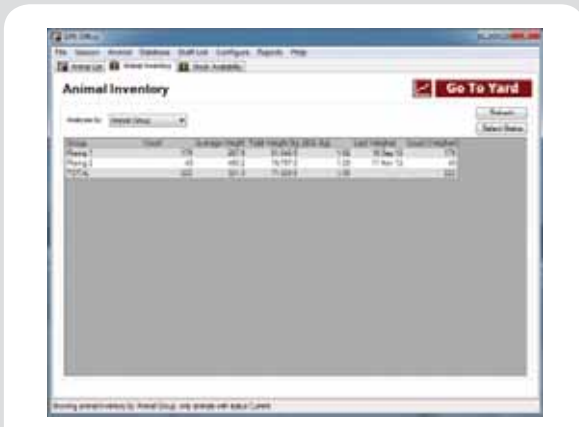

See what stock is located where and in which groups.

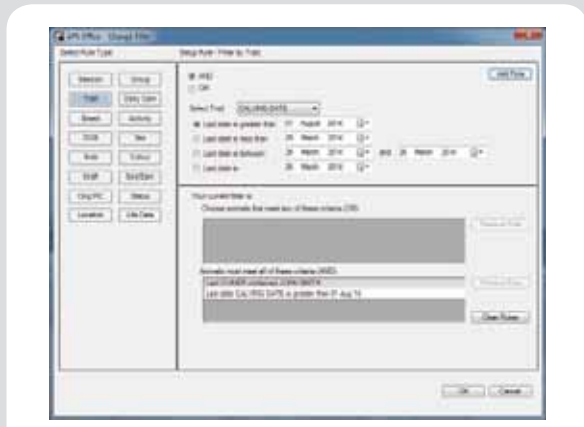

Use advanced filtering capability to refine the information down to your exact need. e.g. Decide which pregnant ewes to leave out the back vs. those to bring in closer for birthing.

Animal Performance Software (APS) Standard

New icon based menus, shown on the screen below, make it quick and easy to view and use current and historical information on an individual animal level.

- Pre-set reporting enables quick analysis of frequently accessed information i.e. full animal/mob history, predict the weight of animals at a given date or the date animals will reach a given weight
- Easy information sharing between vets, ranch managers and owners
- Hassle free transfer of animal data
- Can be upgraded to APS Professional for a fee.

Intuitive side menu to access other program features e.g. connection to device or creation of draft lists.

Easy access icons to print, email or view session data.

Easily view sessions stored on PC with animal count.

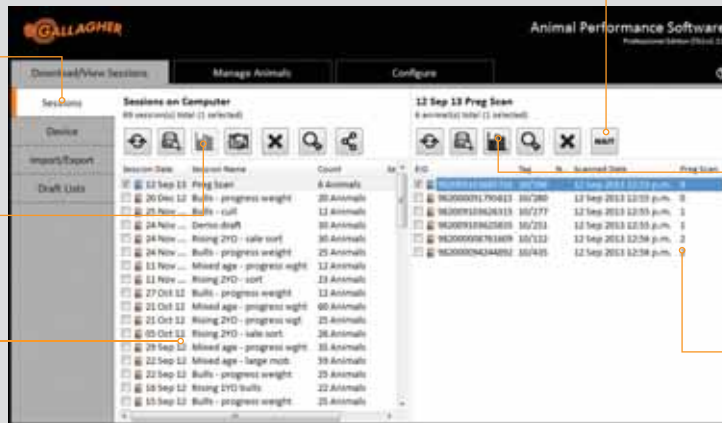

Simple compliance with national traceability schemes.

View individual weight gain charts or full animal history and life data information.

View session contents at a glance. Click on column heading to re-order.



Gallagher Animal Data Transfer App

Transfer animal data from your Gallagher Hand Held EID Tag Reader or EID compatible weigh scale to your Android Smart Phone and then onto other programs, without the need to connect your device to a PC.



ANDROID SMART PHONE

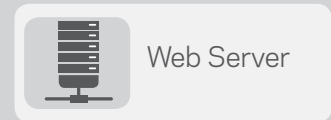

Web Server

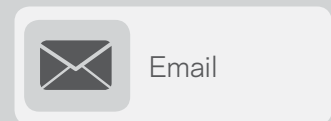

Email

50 Sheep Auto Drafter

Sheep Auto Drafter

G05714

The Sheep Auto Drafter is a fully automated weighing and drafting system that is smoother, quieter and easier to set up and operate than any other sheep drafting product on the market. The Gallagher Sheep Auto Drafter includes the weigh crate, integrated load cells, integrated control module with remote control and three way draft module. Just add a suitable electronic weigh scale and you're ready to go!



Remote control operation - Unit can be controlled by one operator.



Flexible - Adjustable sides to handle small lambs to the largest rams.



High visibility control panel - Includes emergency stop button, auto/manual status & fault lamp.

**QUALITY
WATER
PROMOTES
LIVESTOCK
RATE OF GAIN**

Miraco Watering Tank Systems

Miraco has been offering healthy, clean, fresh livestock water systems to producers since 1974.



Miraco tanks can withstand cold temperatures without freezing



5 Year warranty offered on all Miraco Tanks



Poly construction makes these tanks durable. Multiple colour options available on select tanks

Miraco perfected energy-free watering systems and was the first to manufacture automatic livestock waterers from poly materials. Join other livestock producers who enjoy the innovative features of Miraco Livestock Watering Systems.

E-Fount Waterers

E-Founts are the most economical electric heat waterers available today.

All E-Founts come equipped with a 50 watt heat element and thermostat. E-Founts only require 4 kilowatts of electricity during a week of -25 F temperatures.

MiraFount Waterers

MiraFount Tanks were the first livestock tanks in the world to be developed energy free. These innovative tanks have urethane insulation and have extra insulation above the valve area. Water stays cool in warm temperatures and does not freeze in cold conditions.

MIRACO
Livestock Water Systems

Manufactured
in U.S.A.

52 Miraco Livestock Waterers

MiraFount A3390



Energy Free

Capacity: 150 head beef
60 head dairy

Gallons: 44

Specifications: Two 10" openings/
10.75" ball closures

Dimensions: 43"x 29"x 20" (L x W x H)
109 x 74 x 51 cm (L x W x H)

Weight: A3390 - 126 pounds (57 kg)
A3390-E - 129 pounds (58 kg)

Drinking Height: 20" (51 cm)

- Split top-end panels can be easily removed to help get new cattle started fast. Or, remove the panels to provide more capacity for a few extra head.

E-Fount A3390-E



Energy Efficient
Heat Element: 50 Watts

MiraFount A3330



Energy Free

Capacity: 50 head beef
25 head dairy

Gallons: 15

Specifications: One 8.75" opening/9" ball closure

Dimensions: 28"x 26"x 14" (L x W x H)
71 x 66 x 36 cm (L x W x H)

Weight: A3330 - 59 pounds (27 kg)
A3330-E - 57 pounds (26 kg)

Drinking Height: 14" (35.5 cm)

- Stainless Steel anchor bolts are included

E-Fount A3330-E



Energy Efficient
Heat Element: 50 Watts

MiraFount A3465



Energy Free

Capacity: 100 head beef
40 head dairy

Gallons: 20

Specifications: Two 9.25" openings/ 10" ball closures

Dimensions: 36"x 24"x 18" (L x W x H)
91 x 61 x 46 cm (L x W x H)

Weight: 79 pounds (36 kg)

Drinking Height: 18" (46 cm)

- Stainless Steel anchor bolts are included

E-Fount A3465-E



Energy Efficient
Heat Element: 50 Watts

MiraFount A3345-S



Energy Free

Capacity: 75 head beef
30 head dairy

Gallons: 30

Specifications: One 10" opening / removable top

Dimensions: 29" x 31" x 18" (L x W x H)
73.6 x 109 x 66cm (L x W x H)

Weight: 95 pounds (43 kg)

Drinking Height: 18" (46 cm)

- Stainless Steel anchor bolts are included

E-Fount A3345-E



Energy Efficient
Heat Element: 50 Watts

MiraFount A3354-S



Energy Free

Capacity: 200 head beef
90 head dairy
Gallons: 70
Specifications: Four 9.5" openings/ 10.75" ball closures
Dimensions: 57.5"x 32.5"x 19" (L x W x H)
82 x 146 x 48 cm (L x W x H)
Weight: 152 pounds (69 kg)
Drinking Height: 19" (48 cm)

- Removable top-end panels help get new cattle started fast

E-Fount A3354-SE



Energy Efficient Heat Element:
Two 50 Watt Heaters



E-Fount A3340-E



Capacity: 100 head sheep
Gallons: 15
Specifications: Four 6" openings / 7" ball closures
Dimensions: 28" x 26" x 14" (L x W x H)
66 x 71 x 36 cm (L x W x H)
Weight: 57 pounds (26 kg)
Drinking Height: 14" (35.5 cm)
Heat Element: 50 watts

Also available as Energy Free **MiraFount A3340**

MiraFount A3410



Energy Free

Capacity: 100 market hogs
50 sows
Gallons: 6
Specifications: Two lift up lids / 10" openings
Dimensions: 34" x 19" x 16" (L x W x H)
86 x 48 x 41 cm (L x W x H)
Weight: A3410-E - 57 pounds (26 kg)
A3410 - 52 pounds (24 kg)
Drinking Height: Low drinking profile for small pigs

- Two large drain holes with rubber plugs for easy cleaning

E-Fount A3410-E

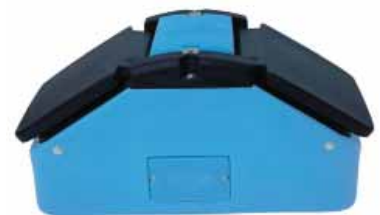

Energy Efficient
Heat Element: 50 Watts

MiraFount A3410-4



Energy Free

Capacity: 200 market hogs
100 sows
Gallons: 15
Specifications: Four lift up lids / 10" openings
Dimensions: 34" x 36.5" x 16" (L x W x H)
86 x 48 x 41 cm (L x W x H)
Weight: A3410-4E - 98 pounds (45 kg)
A3410-4 - 95 pounds (43 kg)
Drinking Height: Low drinking profile for small pigs

- Two large drain holes with rubber plugs for easy cleaning

E-Fount A3410-4E



Energy Efficient
Heat Element: 50 Watts

54 Miraco Livestock Waterers

MiraFount

A3370-S



- Capacity: 250 head beef
120 head dairy
200 cow/calf units
- Gallons: 100
- Specifications: Six 9.5" openings/ 10.75" ball closures
- Dimensions: 57.5"x 45.5"x 20" (L x W x H)
146 x 115 x 51 cm (L x W x H)
- Drinking Height: 20" (51 cm)
- Weight 216 pounds (98 kg)
- Features removable end panels to help get new cattle started fast or to provide more capacity for a few extra head. Two valves are provided for fast recovery



Lil'Spring

A2700



- Capacity: 100 head sheep
- Gallons: 6
- Dimensions: 28.75" x 17.5" x 14" (L x W x H)
73 x 44.5 x 35.5 cm (L x W x H)
- Drinking Height: 14" (35.5 cm)
- Weight: 40 pounds (18.15 kg)
- Heat: Optional, 250-watt submersible heater (A160)

Lil'Spring Tank Waterers

Features:

- One-piece body polyethylene construction
- No sharp edges
- Tough high impact resistant "Rockite" material to stand up to livestock abuse
- Resistant to corrosion
- Removable dome for quick and easy access to the valve area
- 2-3" urethane foam insulation
- Molded base unit anchors (stainless steel anchor bolts are included with all models)
- Sloped bottom for easy cleaning
- Sealed bottoms
- Color options are available
- Optional heater may be added

Lil'Spring

A2800

- Capacity: 20 head beef
20 head horses
- Gallons: 4
- Dimensions: 20" x 16" x 27" (L x W x H)
51 x 41 x 69 cm (L x W x H)
- Drinking Height: 19" (48 cm)
- Valve: Miraco automatic plastic
- Weight: 40 pounds (18 kg)
- Heat: Optional 110-volt, 250-watt submersible heater (A160)



- 200 psi hose w/shut off valve included
- Attractive design; five color options: Gray, Standard Blue, Black or Hunter Green

Lil'Spring

A2900

Capacity:	40 head beef 40 head horses
Gallons:	6
Dimensions:	30.5" x 16.5" x 27" (L x W x H) 77.5 x 40.6 x 69 cm (L x W x H)
Drinking Height:	19" (48 cm)
Valve:	Miraco automatic plastic
Weight:	48 pounds (18 kg)
Heat:	Optional 110-volt, 250-watt submersible heater (A160)

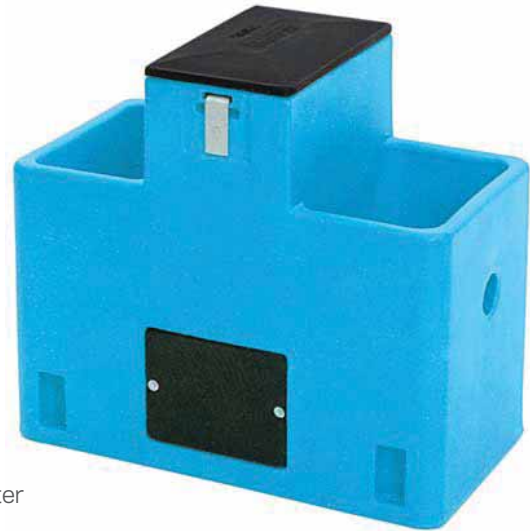

- 200 psi hose w/shut off valve included
- Attractive design; five color options: Gray, Standard Blue, Black or Hunter Green
- Anchor bolts are included



"I'm only interested in the best for my horses and Miraco watering systems are the best. These are strong, durable systems ergonomically designed to make it easy for the horse to get access to drink. Miraco products are also safe for the horse, and that's really important to me."

Curt Pate

World-renowned South Dakota horse trainer and clinician, film consultant and author

Miraco Tank Installation Diagram

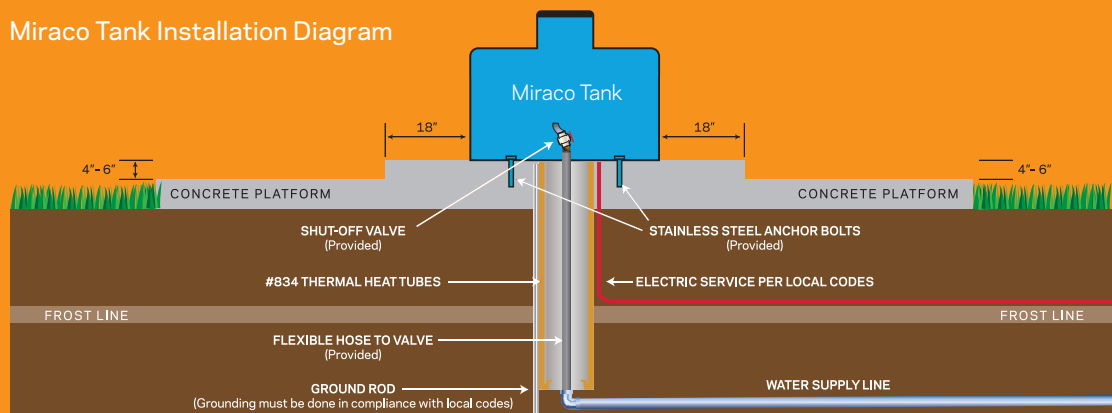

56 Miraco Livestock Waterers

Lil'Spring

A3000



Capacity: 30 head beef
30 head horses
50 head sheep
Gallons: 5
Dimensions: 24" x 22" x 21" (L x W x H)
61 x 56 x 53 cm (L x W x H)
Drinking Height: 24" (61 cm)
Valve: Miraco automatic plastic
Weight: 48 pounds (22 kg)
Heat: Optional 110-volt, 250-watt submersible heater (A160)

- 3" offset drain
- Bottom drain for inside use. 2" threaded fitting underneath for PVC plumbing
- Installs easily on most existing concrete pads.
- Stainless steel anchor bolts included

Lil'Spring

A3100DS



Capacity: 100 head beef
50 head dairy
Gallons: 8
Dimensions: 36" x 22" x 27" (L x W x H)
91 x 56 x 69cm (L x W x H)
Drinking Height: 22" (55.8 cm)
Valve: Miraco automatic plastic
Weight: 75 pounds (34 kg)
Heat: Optional 110-volt, 250-watt submersible heater (A160)

Lil'Spring

A3200



Lil'Spring Extension

A3002

This extension raises the Lil' Spring 3000 and 3001 drinking height from 16" to 28" (40-71 cm) making the water more visible.

It's ideal for installation in paddocks and stalls and prevents livestock from putting feet in the watering bowl.



Capacity: 150 head beef
75 head dairy
Gallons: 25
Dimensions: 48" x 24" x 29" (L x W x H)
122 x 61 x 74 cm (L x W x H)
Drinking Height: 24" (61 cm)
Valve: Miraco automatic plastic
Weight: 98 pounds (45 kg)
Heat: Optional 110-volt, 250-watt submersible heater (A160)

- Large access panel for easy access to valve area with spring load clips
- 3" offset drain
- Access panels at both ends
- Installs easily on most existing concrete pads
- Constant flow available

Lil'Spring

A3500



Capacity: 225 head beef
110 head dairy

Gallons: 40

Dimensions: 42" x 42" x 26" (L x W x H)
107 x 107 x 66 cm (L x W x H)

Drinking Height: 26" (66 cm)

Valve: Miraco automatic plastic

Weight: 145 pounds (65 kg)

Heat: Optional 110-volt, 250-watt submersible heater (A160)

- 168" Drinking space
- Quick release valve access cover
- Diagonal valve compartment lets more cattle drink
- 24" hook-up hose with shut off valve
- Stainless steel anchor bolts
- 2 Bottom drains

EquiFount features smooth rounded edges for safety with minimum intrusion on stall space

**EquiFount Corner Mount**

A1100



Dimensions:
16" x 16" x 14"
(L x W x H)

41 x 41 x 36 cm
(L x W x H)

EquiFount Wall Mount

A1200



Dimensions:
16" x 16" x 14"
(L x W x H)

41 x 41 x 36 cm
(L x W x H)

Capacity: 1 Horse

Gallons: 1

Drinking Height: 26" (66 cm)

Heat: Optional 110-volt, 250-watt submersible heater (A276)

- Smooth rounded edges for safety
- Durable 100% polyethylene construction; urethane foam insulation
- Easy valve access; one-screw, quick water level adjustment
- Four-bolt installation
- Plumb from above or below
- Ample drinking space; plentiful water supply with minimal waste
- Large easy drain; no disassembly required
- Attractive design; five color options: Gray, Standard Blue, Black or Hunter Green

EquiFount Insulated Ext Tube

A834-5



- Cold barns are not a problem for EquiFount waterers. This insulated extension tube allows water line to enter from below without freezing
- Rubber plug can be removed for access to water shut-off valve

58 Miraco Livestock Waterers

BigSpring Waterers are the preferred choice of cattle & dairy producers

BigSpring

A6000



Capacity: 250 head beef
100 head dairy
Gallons: 60
Dimensions: 90" x 33" x 24" (L x W x H)
229 x 84 x 61 cm (L x W x H)
Drinking Height: 24" (61 cm)
Weight: 215 pounds (97 kg)

- Optional 500 watt heater (110 or 220 volt - A162)
- Optional constant flow (30 or 60 gallon level)
- Water spray for attracting new cattle to water
- 3" (8 cm) drain hole with rubber plug for rapid cleaning
- Removable dome for easy access to valve area
- Spring-loaded clips - no wrenches required
- Rubber gasket for air-tight dome seal
- End panel access
- For cleaner water, neckrail to prevent cattle from standing in the water

BigSpring

A6100



Capacity: 110 head dairy
Gallons: 60
Dimensions: 80" x 36" x 24" (L x W x H)
203 x 91 x 155 cm (L x W x H)
Drinking Height: 24" (61 cm)
Weight: 205 pounds (93 kg)

- Optional 500 watt heater (110 or 220 volt - A162)
- Flat back design fits flush with the wall
- Center between stalls or place one on each
- Curved front for full, easy access - no wasted space
- Pour foundation with a curve for easier cleaning
- No wrenches required for valve compartment access
- Rubber gasket for air-tight dome seal
- Recommended installation on 10" concrete riser or with neck rail
- Optional gravity fill assemble available
- Stainless steel anchor bolts included
- For cleaner water, neckrail to prevent cattle from standing in the water

BigSpring

A6200

Capacity: 200 head beef
100 head dairy
Gallons: 60
Dimensions: 84" x 22" x 22" (L x W x H)
213 x 56 x 56 cm (L x W x H)
Drinking Height: 22" (56 cm)
Weight: 170 pounds (77 kg)

- Designed for free stall barns
- Flat back design for flush fit with a wall or panel
- Three access panels and no wrenches required for valve compartment access
- Two large 3" (8 cm) drains, severe slope for quick draining
- Rubber gasket for air-tight dome seal
- Optional 500 watt heater (110 or 220 volt - A162)



BigSpring

A6300

Capacity: 300 head beef
150 head dairy
Gallons: 110
Dimensions: 144"x 22"x 22" (L x W x H)
366 x 56 x 56 cm (L x W x H)
Drinking Height: 22" (56 cm)
Weight: 275 pounds (125 kg)
Heat: Optional 500 watt heater (110 or 220 volt - A162)



BigSpring

A6400

Capacity: 250 head beef
125 head dairy
Gallons: 90
Dimensions: 120"x 22"x 22" (L x W x H)
305 x 56 x 56 cm (L x W x H)
Drinking Height: 22" (56 cm)
Weight: 230 pounds (104 kg)
Heat: Optional 500 watt heater (110 or 220 volt - A162)

Water Tank Accessories

Hook Up Kits (A158) 2' (.6M) rubber hose (200 psi) with shut off valve



Underground Shut Off Kit (A399-5) Comes with drain back

Insulated Heat Tubes (A834)

Outside Dimensions 14" x 30" (355mm x 762mm), Insulation is 2" (50mm)
Weight: 16 pounds (7 kg)
Highly insulated tube shields incoming ground water from cold as it passes through the frost level. Polyethylene construction ensures years of trouble free use. One 20" (508mm) tube and 3' of 12" (25mm of 304mm) plastic drainage tile provide sufficient heat in most locations. For northern locations two 30" (762mm) heat tubs may be required.



Automatic Valves (A336)

GPM 14, Low pressure 5 - 40 psi

Automatic Valves (A521)

GPM 12.5, High pressure 40 -80 psi

Automatic Valves (A519)

GPM 6, Super high pressure 80 - 90 psi



Pet Waterer

A1000

- All polyethylene construction for easy cleaning
- No buildup of bacteria or algae
- Full polyurethane foam insulation
- 5 gallon reservoir - add ice during hot weather
- Bowl refills automatically - no moving parts
- Optional 250 watt heater assembly (A250)



Heaters, Cable & Floating Tank Valves

250 Watt Immersion Heater (A160)

Has a built-in thermostat 550
Teflon coated, 1-Yr Warranty

500 Watt Immersion Heater (A162)

110 Volt or 220 Volt
Teflon coated, 1-Yr Warranty



5'/ 1.5mm Cable Line Heater (A919-5)

8'/ 2.4mm Cable Line Heater (A919-8) - 110 Volt or 220 Volt

Gallagher .75"/ 19mm Water Tank Brass Valve with Float (AQ100B)

Gallagher .75"/ 19mm Water Tank Poly Valve with Float (AQ400P)

1"/ 25mm Water Tank Poly Valve with Float (AQ500P)



