

LED Direct Wire Linking Under Cabinet Bar (Page 1)

Connexion par raccordement direct de la barre DEL sous le meuble (Page 4)

Cómo enlazar las luces LED de cableado directo debajo de la barra del gabinete (Página 8)

To Begin/Pour commencer/Para comenzar

- ⚠ WARNING:** Please read this entire manual before installation. Verify the following contents:
- ⓕ AVERTISSEMENT :** Veuillez lire ce mode d'emploi du début à la fin avant de commencer l'installation. Vérifiez le contenu suivant :
- Ⓢ ADVERTENCIA:** Por favor, lea este manual completo antes de realizar la instalación. Verifique el siguiente contenido:

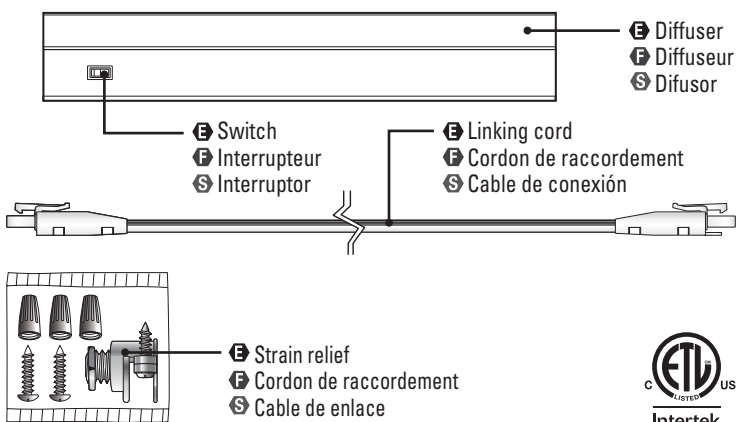

- ⓕ Hardware kit (Actual hardware may differ from illustration).**
ⓕ Trousse de quincaillerie (La quincaillerie incluse peut être différente de l'illustration.)
Ⓢ Kit de aditamentos (Los aditamentos reales pueden diferir de los que se muestran en la ilustración.)

Required/Nécessaire/Se necesita

- ⓕ Installation time: 45 minutes**
ⓕ Temps d'installation : 45 minutes
Ⓢ Tiempo de instalación: 45 minutos
- ⓕ Safety glasses** / **ⓕ Lunettes de sécurité** / **Ⓢ Gafas de seguridad**
 - ⓕ Phillips screwdriver** / **ⓕ Tournevis cruciforme** / **Ⓢ Destornillador Phillips**
 - ⓕ Flathead screwdriver** / **ⓕ Tournevis à tête plate** / **Ⓢ Destornillador de cabeza plana**
 - ⓕ Wire cutters** / **ⓕ Coupe-fil** / **Ⓢ Pinzas cortacables**
 - ⓕ Electrical tape** / **ⓕ Ruban isolant** / **Ⓢ Cinta aislante**
 - ⓕ Drill bits 1/16 in.** / **ⓕ Forets de 1/16 po** / **Ⓢ Brocas para taladro de 1/16 pulg**
 - ⓕ Drill** / **ⓕ Perceuse** / **Ⓢ Taladro**
 - ⓕ Pliers** / **ⓕ Pinces** / **Ⓢ Pinzas**
 - ⓕ Wire strippers** / **ⓕ Pinces à dénuder** / **Ⓢ Pinzas pelacables**

English

Warnings and Cautions

WARNING

- Shut off power at the circuit breaker or fuse panel before removing the old fixture or installing the new one.
- LEDs can be damaged by electro static discharge (ESD) shock. Before installation, discharge yourself by touching a grounded bare metal surface to remove this hazard.

CAUTION

- This device complies with Part 15 of the FCC rules. Operation is subject to the following two conditions: (1) This device may not cause harmful interference, and (2) this device must accept any interference received, including interference that may cause undesired operation.

Important Safety Instructions

WARNING: To reduce the risk of FIRE, ELECTRIC SHOCK, OR INJURY TO PERSONS:

1. For **INDOOR USE ONLY**.
2. Do NOT touch LEDs.
3. Do NOT look directly at lighted LEDs for any length of time.
4. Do NOT touch, operate, or install fixture while in contact with water.
5. Not intended for illumination of aquariums.
6. Do NOT mount over sinks or stoves.
7. Do NOT mount the light to cabinets having a material thickness less than 1/4 in.
8. Do NOT install the fixture inside of enclosed cabinets.
9. Electrical requirements for **UC1052-SGM-12LF0-E, UC1052-SGM-18LF0-E and UC1052-SGM-24LF0-E:** 120 V AC, 60 Hz, 0.14 A MAX. Electrical requirements for **UC1052-SGM-30LF0-E:** 120 V AC, 60 Hz, 0.17 A MAX.
10. Do not leave bare wires exposed outside of the electrical compartment.

SAVE THESE INSTRUCTIONS IN A LOCATION CLOSE TO THE FIXTURE TO REFER TO THEM AT A LATER TIME.

Dimmer Instructions

THIS FIXTURE IS DIMMABLE BY SPECIFIC FORWARD PHASE ELECTRONIC (TRAIC) DIMMERS. Dimmers tested to be compatible with this fixture are the Lutron® Diva® C*L™: DVWCL-153P* or DVCL-153P*, Lumea® C*L™: LGCL-153P*, and Toggler® C*L™: TGCL-153P*. Not recommended for use with motion or light sensors, timers, or any other external controls.

Direct Wire Installation

Disconnect power to the electrical box and remove the old fixture. If more than two wire leads are present, keep track of which wires were connected together.

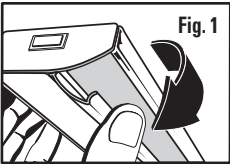
- 

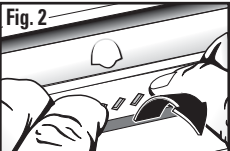
1 Remove the diffuser by pulling back and away from the bottom edge of the fixture (**Fig. 1**).
- 

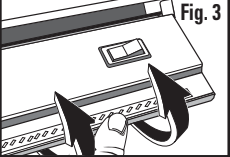
2 To open the wire compartment cover, disengage each locking tab by carefully pushing in the front side of wire compartment cover above the LED (**Fig. 2**) and lifting it up to expose the wire connections and hardware kit inside (**Fig. 3**). **NOTE:** Be careful not to damage the LEDs when disengaging the wire compartment cover.
- 

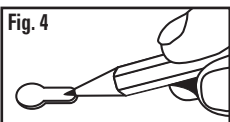
3 Mark the general area where the fixture will be installed. Locate the mounting keyhole slots on the back of the fixture. Place the fixture in position and mark the slots on the mounting surface (**Fig. 4**). Using an awl or nail, dimple the surface or drilling a 1/16 in. pilot hole will make installing the screws easier.
- 

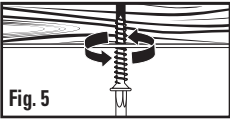
4 Tighten the screws, leaving 3/8 in. of the screw protruding from the surface (**Fig. 5**).
- 

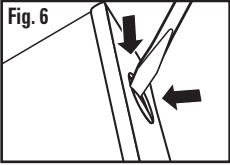
5 Determine which corresponding knock-out is closest to the supply wire feed and remove it. **CAREFULLY REMOVE THE KNOCK-OUT BY HAMMERING IT WITH A FLATHEAD SCREWDRIVER OR PUNCH UNTIL THE SURFACE BREAKS (Fig. 6).** If the knock-out does not break free, use pliers to bend it back and forth until it snaps free.
- 

6 Attach the strain relief by inserting the threaded end through the knock-out (**Fig. 7**). Secure the strain relief to the fixture by tightening the fastener to the threaded tube. **NOTE:** Remember to have the strain relief screws oriented in a manner that allows tightening/loosening of the clamp after the fixture has been attached to the mounting surface.

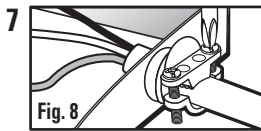

7 Insert a flexible whip or NM cable (not included) through the strain relief and tighten the clamp until it is secure (**Fig. 8**). Allow enough wire length to complete the connections. **WARNING:** Make sure the POWER is OFF.

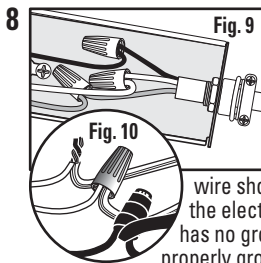

8 For safety and proper operation, the fixture must be properly grounded. If unfamiliar with the methods of properly grounding the fixture, consult a qualified electrician. A copper ground wire is pre-attached to the fixture. If the electrical box is made of plastic and has a green or bare copper grounding wire inside, the fixture grounding wire and the electrical box ground wire should be connected using one of the wire nuts. If unsure if the electrical box is properly grounded, or the box is plastic and has no ground wire, or are unfamiliar with the methods of properly grounding the fixture, consult a qualified electrician. If the fixture is being connected using a flexible whip or NM cable, the fixture grounding wire and the electrical supply ground wire should be connected using one of the wire nuts. Connect the supply leads to the fixture wire leads using the supplied wire nuts. The black leads from the fixture go to the black supply lead and the white leads from the fixture go to the white supply lead (**Fig. 9**). Tighten the wire nuts properly to prevent the wires from coming loose. If unsure of tightness, tape the wire nuts to the wire using electrical tape. (**Fig. 10**). Carefully push any excess wiring back inside the fixture.

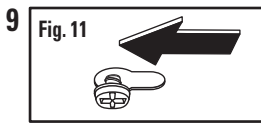

9 Slide the fixture over until the narrow ends of the keyhole slots are under the heads of the wood screws (**Fig. 11**). Finish tightening the wood screws until the fixture is tightly secured to the mounting surface.

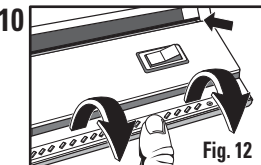

10 Re-attach the wire compartment cover by hinging the back edge of the cover with the fixture chassis and lowering it into position (**Fig. 12**). Press the front edge of the wire compartment cover inward until it engages with all the locking tabs (**Fig. 13**).

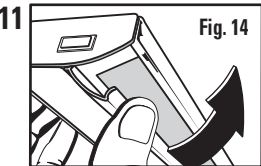
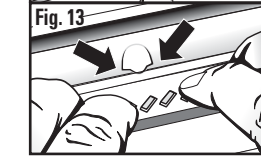

11 Re-install the diffuser (**Fig. 14**).

Linking Directions

With power disconnected, each additional fixture (not included) should be mounted in the same manner as the first installed fixture. Make sure that the distance between fixtures does not exceed the connector cord length of 18".

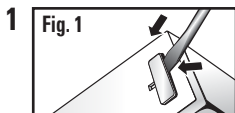

1 Using a flathead screwdriver, carefully pry off the plastic cap that covers the power port on the fixture (**Fig. 1**).

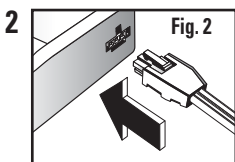

2 **NOTE:** The linking cord is fitted with a distinct cord connector plug at each end and will only connect one way. Try inserting one end of the linking cord into the power port, if that fails try the other end of the linking cord (**Fig. 2**). Do not try to force the plug into the port. When correctly inserted the catch on the top of the cord connector plug will click into the power port.

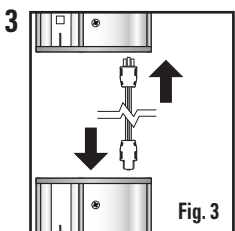

3 Link additional fixtures by following the linking instructions outlined in steps 1 and 2 (**Fig. 3**). Once all fixtures have been linked, insert the power cord connector plug into the power port on the end of the last fixture and the grounded plug into the outlet. **NOTE:** Each light can be individually operated by the on/off switch located on each fixture.

Troubleshooting Guide

Minor problems often can be fixed without the help of an electrician. Before doing any work on the fixture, shut off power supply at the circuit breaker panel to avoid electrical shock.

Problem	Cause	Solution
Fixture doesn't light.	Power is off.	Check if power supply is on.
	Connection is bad.	Check cords and/or wiring.
	Switch is bad.	Test or replace switch.
Fuse blows or circuit breaker trips when light is turned on.	Discontinue use.	Call customer service.

Care and Maintenance

IMPORTANT: This fixture uses LEDs (light emitting diodes) to provide light. LEDs do not burn out like traditional light bulbs and will last for 30 years or more (based on 3 hours of usage per day).

Periodically clean the fixture and diffuser using a mild, non-abrasive cleaner and soft cloth. When cleaning the fixture, make sure the power is turned off. Do not spray cleaner directly onto any part of the fixture or LEDs.

Replacement Parts List

Keep this guide handy for ordering replacement parts.

Hardware Kit
ZH-UC1052F00-SGM

Need Help?



In the event you are missing a part or have questions regarding installation please visit our website at www.goodearthlighting.com/support or call the Customer Care Center **1-800-291-8838**, 8:30 a.m.-5 p.m., CST, Monday-Friday.



Ecolight® Warranty

6 YEAR LIMITED WARRANTY

The manufacturer warrants this lighting fixture to be free from defects in materials and workmanship for a period of (6) years from the date of original purchase by the consumer. The fixture is not warranted for use in a commercial or retail application. The warranty is limited to use in a residential environment. We will repair or replace (at our option) the unit in the original color and style if available, or in a similar color and style if the original item has been discontinued, without charge. Defective units must be properly packed and returned to the manufacturer with a letter of explanation and your original purchase receipt showing date of purchase. Call **1-800-291-8838** to obtain a return authorization number and an address where to ship your defective product. Note: C.O.D. shipments will NOT be accepted. The liability of the manufacturer is in any case limited to replacement of the defective light fixture product. The manufacturer will not be liable for any other loss, damage, labor costs or injury which is caused by the product. This limitation upon the liability of the manufacturer includes any loss, damage, labor costs or injury which is (I) to person or property or otherwise; (II) incidental or consequential in nature; (III) based upon theories of warranty, contract, negligence, strict liability, tort, or otherwise; or (IV) directly, or indirectly related to the sale, use, or repair of the product. This warranty gives you specific rights, and you may also have other rights which vary from state to state.

Ecolight® 1400 East Business Center Drive, Ste. 108 Mount Prospect, IL 60056

Printed in China

Ecolight® is a registered trademark of Good Earth Lighting, Inc. All rights Reserved.