

GIBRALTAR

INDUSTRIES

BUILDING ACCESSORIES DIVISION



PRODUCT CATALOG

Trims & Flashing
Metal Roofing
Ventilation
Drywall Bead
Stucco & Plaster
Soffit & Fascia
Steel Framing
Gutter Protection
Siding & Accessories
Safety Products



GIBRALTAR
INDUSTRIES

www.gibraltarbuildingproducts.com



SEMCOTM
SOUTHEASTERN METALS

PRODUCT CATALOG

Trims & Flashing
Metal Roofing
Ventilation
Drywall Bead
Stucco & Plaster
Soffit & Fascia
Steel Framing
Gutter Protection
Safety Products

GIBRALTAR
INDUSTRIES

www.gibraltarbuildingproducts.com

Quality Guaranteed



Southeastern Metals™ produces over 3,000 galvanized, steel and aluminum building components, specializing in metal roofing, ventilation products, trims, flashings, steel framing, corner bead and drywall accessories. Every product is precision engineered and manufactured to the highest standards to promote greater strength and durability while enhancing overall structural integrity after installation.

Since the company's foundation in 1963, Southeastern Metals™ has grown into one of the region's leading manufacturers of metal building products. In 1997, Gibraltar Industries acquired the company, uniting the quality product line of Southeastern Metals™ with the nationally respected brand name of Gibraltar. As a member of the Gibraltar Industries family, Southeastern Metals™ is part of a billion dollar network of manufacturers expanding across the globe. With the support and backing of Gibraltar, Southeastern Metals™ will remain the name you can trust for quality metal building products.

Southeastern Metals' strong focus on excellence means our customers can expect superior products and outstanding service every time they call. Our metal roofing adheres to the strictest standards, being both Miami Dade County, and Florida Building Code approved.

Southeastern Metals' corporate office and manufacturing base is headquartered on a 300,000 square-foot complex in Jacksonville, Florida allowing us to service over 1,900 locations in the southeastern United States, and beyond.

GALVANIZED STEEL

All galvanized steel products are zinc coated as specified by ASTM-A-653, Federal specification AA-S-775 E.

Caution: Do not use in contact with copper or pressure treated lumber

ALUMINUM

All aluminum products are as specified by ASTM B-209, Federal specification QQ-A-250 E.

Caution: Avoid direct contact with dissimilar metal and with concrete or mortar

FINISH

All bare 26 gauge galvanized products have a zinc coating of G-90 for corrosion resistance.

All painted products have a gloss polyester color coating over primer.

CUSTOMER SERVICE: 800-874-0335 • FAX 904-696-2536 • DELIVERIES: 7 TO 10 BUSINESS DAYS

GALVANIZED STEEL

Gauge	Thickness	Max.	Min.	Lbs./Sq. Ft.
20	0.0396	0.0356	0.0436	1.656
22	0.0336	0.0296	0.0376	1.405
24	0.0276	0.0236	0.0316	1.154
26	0.0217	0.0179	0.0247	0.907
28	0.0187	0.0157	0.0217	0.782
29	0.0172	0.0142	0.0202	0.719
30	0.0157	0.0127	0.0187	0.657
ST	0.0120	0.0118	0.0125	0.507
HT	0.0100	0.0098	0.0115	0.408

ALUMINUM

Gauge	Thickness	Max.	Min.	Lbs./Sq. Ft.
20	0.0320	0.0305	0.0365	0.451
22	0.0253	0.0224	0.0284	0.352
24	0.0201	0.0173	0.0234	0.282
26	0.0159	0.0123	0.0183	0.224
28	0.0126	0.0119	0.0132	0.177
29	0.0113	0.0112	0.0122	0.159
30	0.0100	0.0095	0.0115	0.141
ST	0.0145	0.0140	0.0180	0.208
EC	0.0085	0.0078	0.0085	0.123

METAL ROOFING

Corrugated	3
5V Crimp	3
PBR Panel	4
R Panel	4
SM-Rib	5
Sem-Lok	5
Skylight Panels	5
Metal Roofing Trims & Flashing	6

TRIMS & FLASHINGS

Angle Flashing	8
Apron/Dormer Flashing	9
Bullet Boot	9
Drip Edge	10
Eave Drip	11
Formed Valley	12
Ridge Roll	12
Water Diverter	12
Stucco Flashing	13
Z Flashing	13
Step Flashing	14
Flat Sheets	14
Roll Valley	15

VENTILATION

Gooseneck Vent	16
Off Ridge Vents	16
Total JACK™	16
Universal Ridge Vent	17

GUTTER PROTECTION

Clean Mesh	17
Gutter Helmet®	17
Screen-Mesh	17

DRYWALL CORNER BEAD PRODUCTS

J Bead	18
L Bead	18
Drywall Corner Bead	18
Bullnose Corner Bead	18
Arched Corner Bead	18

CONSTRUCTION HARDWARE

H Molding	19
Insulation Support Wire	19
Mobile Home Skirting	19
Termite Shield	19

STUCCO AND PLASTER PRODUCTS

Casing Bead	20
Corner Bead	20
Expanded Corner Bead	20
Vinyl Corner Bead	20

STEEL FRAMING

Diamond Steel Framing Stud	21
Diamond Steel Framing Track	21
Furring Channel	21

SAFETY EQUIPMENT

Rooftop Safety Kit	22
Roof Anchors	22
Shock Absorbing Lanyard	22
Universal Fit Harness	22
Vertical Lifeline	22

INDEX	23
-------------	----



Corrugated exposed fastener roofing panel. 21-1/2 inch width roofing coverage. 24 inch width siding coverage.
Applications: Residential, Agricultural, Architectural, Light Commercial, Industrial

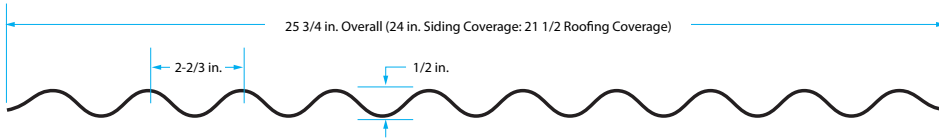

Code Approvals

UL Listing Directory #R20735

UL Fire Resistant Directory #R20735

Florida Building #FL-11175-R1

For the most recent code approval numbers, contact Southeastern Metals' Technical Department or refer to the appropriate code agency.

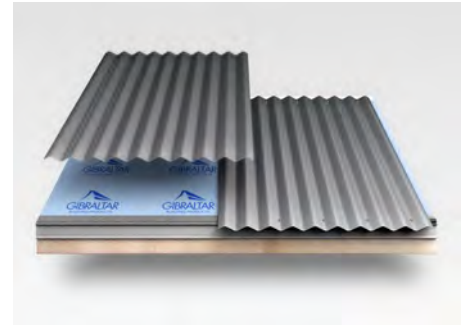

 Regal White <small>24 gauge only</small>	 Barn Red	 Bone White	 Burnished Slate
 Charcoal Gray	 Cocoa Brown	 Forest Green	 Hawaiian Blue
 Light Stone	 Mocha Tan	 Old Town Gray	 Reflective White

NOTE: Colors shown are for reference only. Actual metal color samples are available upon request.

Corrugated Galvanized Steel Panels

Size	Utility	29 Ga.	26 Ga.
6 ft.	13511	-	-
8 ft.	13513	13478	13463
10 ft.	13504	-	13458
12 ft.	13506	13474	13459

G90, conforming to ASTM A446

5V Crimp exposed fastener roofing panel. 24 inch width coverage. Applications: Residential, Agricultural, Architectural, Light Commercial, Industrial

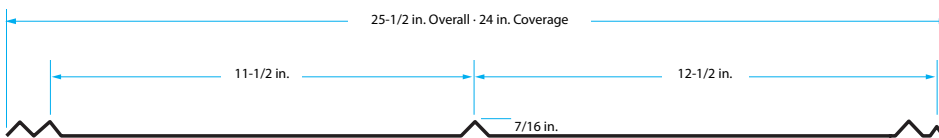

Code Approvals

UL Fire Resistant Directory #R20735

Miami Dade NOA #: 11-0714.08

Florida Building #FL-11175

1. For the most recent code approval numbers, contact Southeastern Metals' Technical Department or refer to the appropriate code agency.

Testing Data & Specifications

Accelerated testing 2000 hours - ASTM G23

Salt Spray testing 1000 hours - ASTM B117

Fire Testing - ASTM E108 or UL 790

Wind Driven Rain - TAS 100



Galvanized Steel 5V Crimp Panels

Size	29 Gauge
8 ft.	13351
10 ft.	13340
12 ft.	13343

G90, conforming to ASTM A446

 Regal White <small>24 gauge only</small>	 Barn Red	 Bone White	 Burnished Slate	 Charcoal Gray	 Cocoa Brown
 Forest Green	 Hawaiian Blue	 Light Stone	 Mocha Tan	 Old Town Gray	 Reflective White

NOTE: Colors shown are for reference only. Actual metal color samples are available upon request.

PBR Panel exposed fastener roofing panel. 36 inch width coverage. Applications: Residential, Agricultural, Architectural, Light Commercial, Industrial

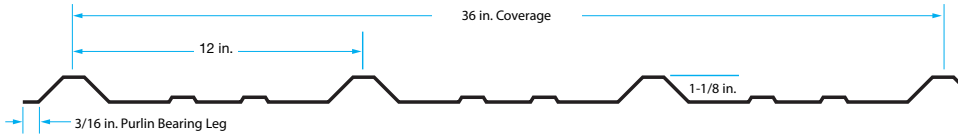

Code Approvals

UL Fire Resistant Directory #R20735
Florida Building #FL-11175

1. For the most recent code approval numbers, contact Southeastern Metals' Technical Department or refer to the appropriate code agency.

Testing Data & Specifications

Accelerated testing 2000 hours - ASTM G23
Salt Spray testing 1000 hours - ASTM B117
Fire Testing - ASTM E108 or UL 790
Wind Driven Rain - TAS 100



PBR Panels are sold by the job pack. Contact our web-based Takeoff and Estimating Services for details.

R Panel exposed fastener siding panel. 36 inch width coverage. Applications: Residential, Agricultural, Architectural, Light Commercial, Industrial

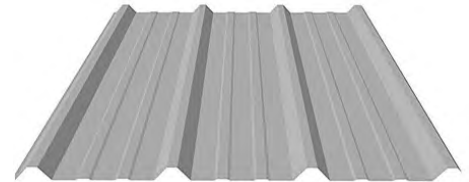
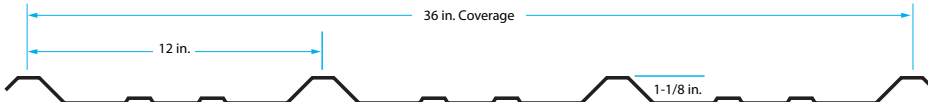

Code Approvals

UL Fire Resistant Directory #R20735
Florida Building #FL-11175

1. For the most recent code approval numbers, contact Southeastern Metals' Technical Department or refer to the appropriate code agency.

Testing Data & Specifications

Accelerated testing 2000 hours - ASTM G23
Salt Spray testing 1000 hours - ASTM B117
Fire Testing - ASTM E108 or UL 790
Wind Driven Rain - TAS 100



R Panels are sold by the job pack. Contact our web-based Takeoff and Estimating Services for details.

40 Year SEMCO Colors



NOTE: Colors shown are for reference only. Actual metal color samples are available upon request.

45 Year SEMCO Colors



SM-Rib exposed fastener roofing or siding panel. 36 inch width coverage Applications: Residential, Agricultural, Light Commercial, Industrial

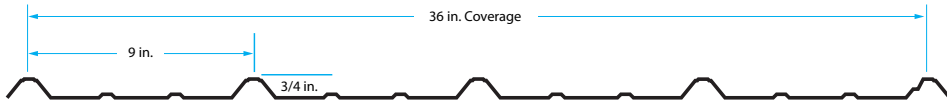

Code Approvals

UL Fire Resistant Directory #R20735
Miami Dade: N.O.A. No. 09-0630.11
Florida Building #FL-11175

Testing Data & Specifications

Accelerated testing 2000 hours - ASTM G23
Salt Spray testing 1000 hours - ASTM B117
Fire Testing - ASTM E108 or UL 790
Wind Driven Rain - TAS 100

SM-Rib Steel Panels 29 Gauge

Size	Galvanized	Galvalume
8 ft.	13560	70031
10 ft.	13542	70032
12 ft.	13544	70033
16 ft.	-	70035



1. For the most recent code approval numbers, contact Southeastern Metals' Technical Department or refer to the appropriate code agency.

Sem-Lok™ standing seam concealed fastener roofing panel. 16 inch width coverage. Applications: Residential, Agricultural, Light Commercial, Industrial

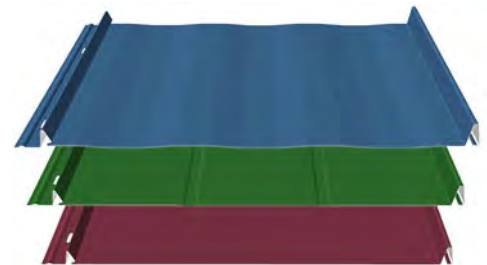
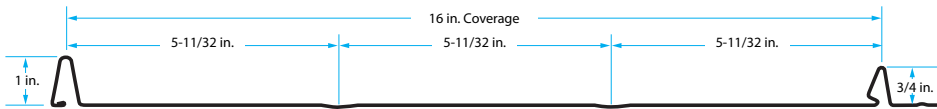

Code Approvals

UL Fire Resistant Directory #R20735
Miami Dade: N.O.A. No. 12-0229.02
Florida Building #FL-11175

Testing Data & Specifications

Accelerated testing 2000 hours - ASTM G23
Salt Spray testing 1000 hours - ASTM B117
Fire Testing - ASTM E108 or UL 790
Wind Driven Rain - TAS 100



Sem-Lok™ Panels are sold by the job pack. Available in Galvalume and SEMCO PLUS finishes, 4 – 40 ft. lengths Contact our web-based Takeoff and Estimating Services for details.

45 Year SEMCO Plus Colors



Brick Red



Chamois Tan



Copper Penny



Hartford Green



Regal Blue



Regal White



Onyx Gray



Silver Dollar



Slate Bronze



Slate Gray

Skylight Panels

Designed to work with SM-RIB and PBR Panels. High performance glazing that stands up to punishing exterior applications. Polycarbonate Panels offer multiple advantages over traditional fiberglass panels: up to 20 times greater impact resistance, the highest light transmission rates, the lowest yellowing index, the highest load rating, and the highest resistance to wind uplift-outstanding properties confirmed in accredited laboratory testing.

Specifications

Material: Polycarbonate
Size: 3 ft. x 4 ft.
Thickness: 0.8 mm
Transparency: Clear



BD-1 Base Drip

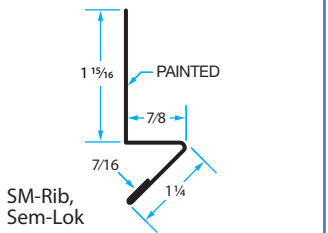

BD-2 Base Drip: 2 inch

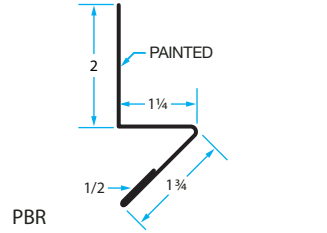

CF-1 Counter Flashing

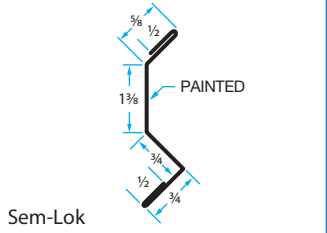

CL-1 Cleat

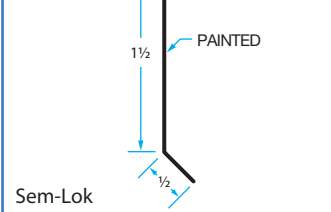

CL-2 Cleat Offset

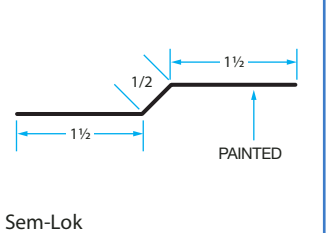

DA-1 Double Angle

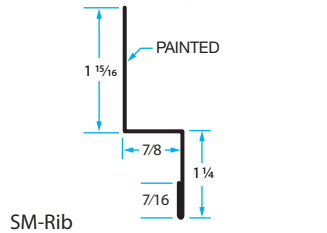

DA-2 Double Angle

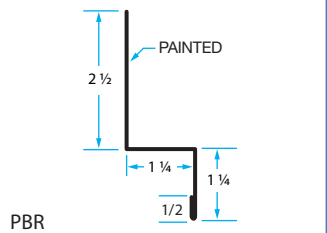

DC-1 Drip Cap

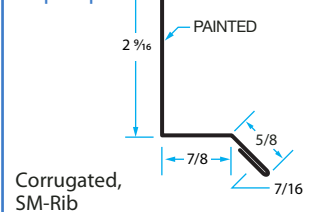

DC-2 Drip Cap

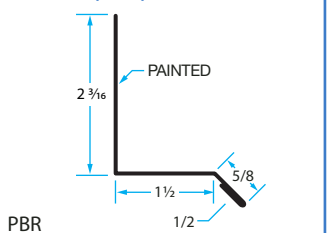

EF-1 Gable Flashing

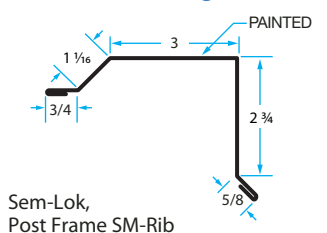

ED-2 Eave Flashing

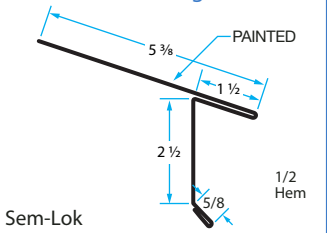

ED-2R Eave Flashing

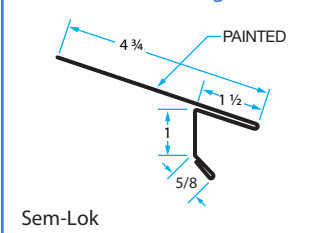

EF-3 Eave Flashing

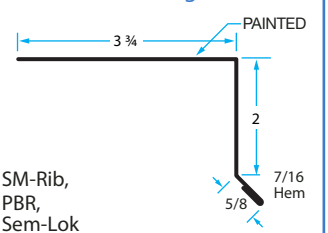

EF-5 Eave Flashing

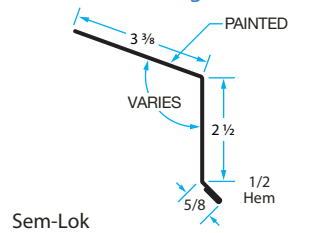

EW-1 Endwall Flashing

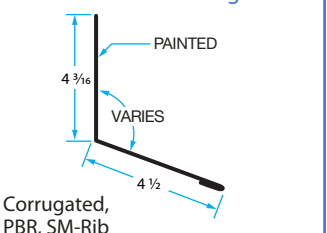

GF-1 Gambrel Flashing

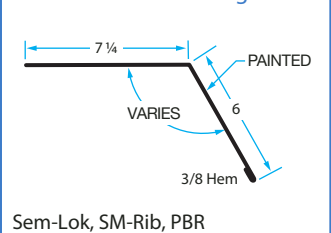

GR-2 Gable Rake & Corner

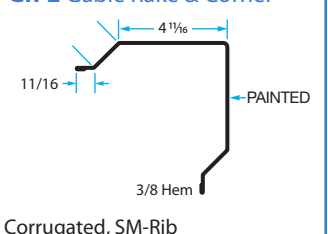

GR-5 Rake Flashing

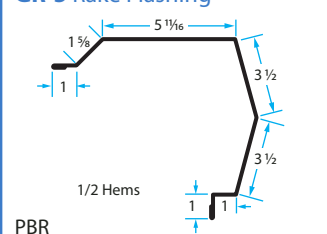

GR-6 Rake & Corner

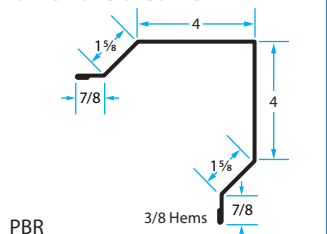

GR-7 Gable Rake

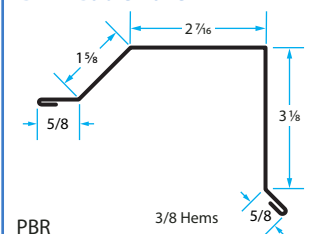

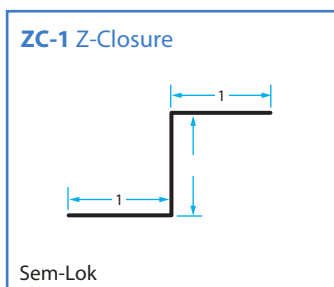
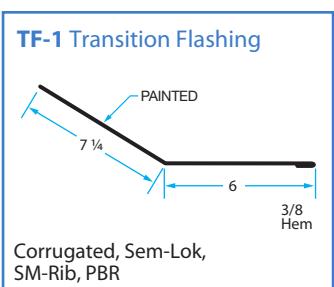
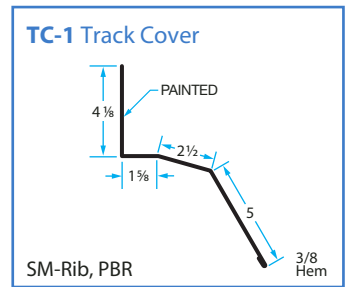
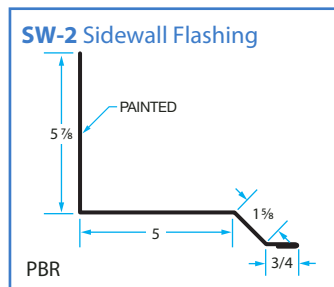
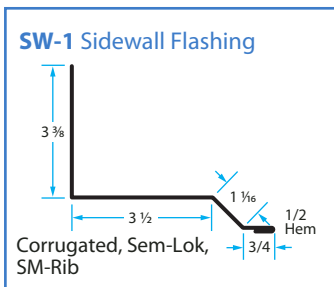
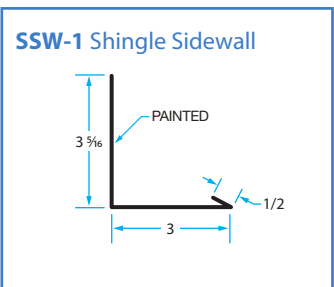
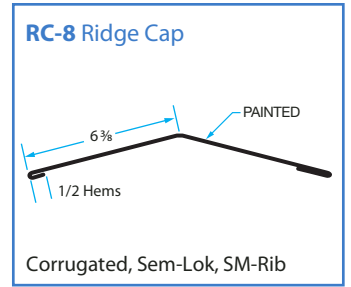
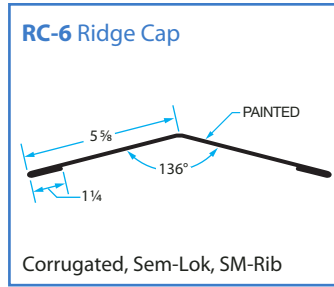
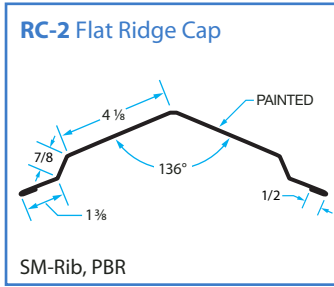
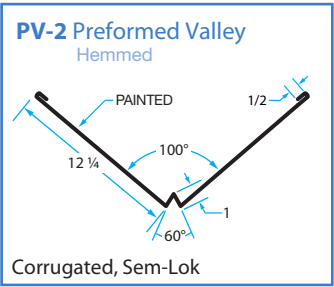
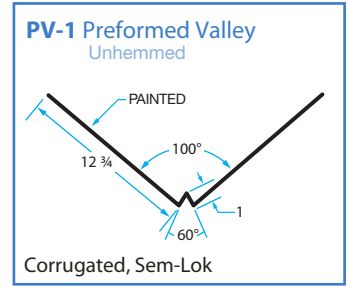
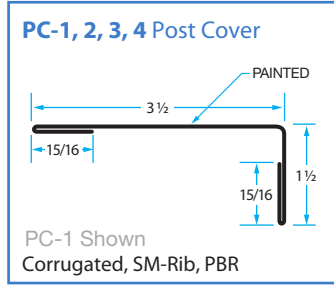
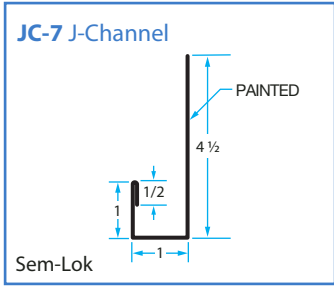
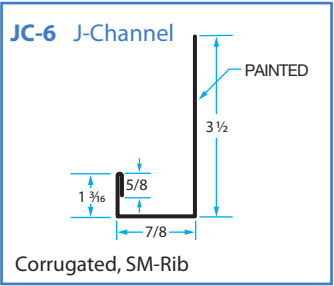
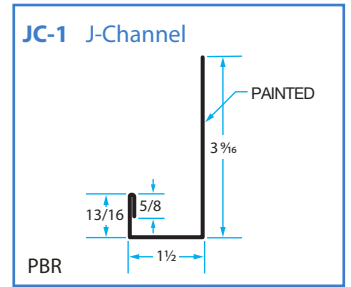
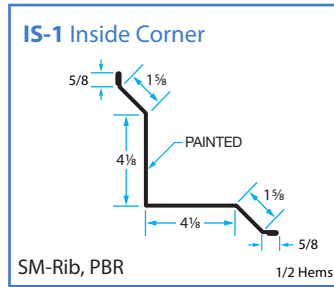
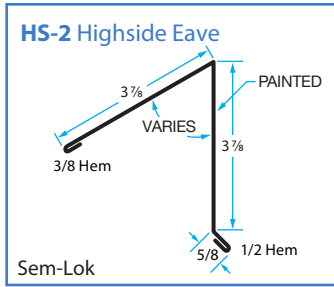
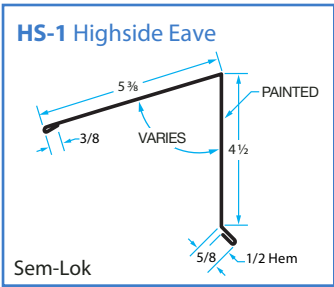

Angle Flashing protects against moisture infiltration at roof-to-wall and chimney intersections. 10 ft. Lengths · 20 Pieces per bundle

Galvanized Angle Flashing

Size - A x B	Description	ST Gauge	26 Gauge
4 in. x 4 in.	Angle Flashing ST Galvanized	10168	-
4 in. x 5 in.	Angle Flashing 26 Gauge Galvanized	-	10110
5 in. x 5 in.	Angle Flashing ST Galvanized	-	10118
5 in. x 7 in.	Angle Flashing 26 Gauge Galvanized	-	10126
6 in. x 6 in.	Angle Flashing 26 Gauge Galvanized	-	10128

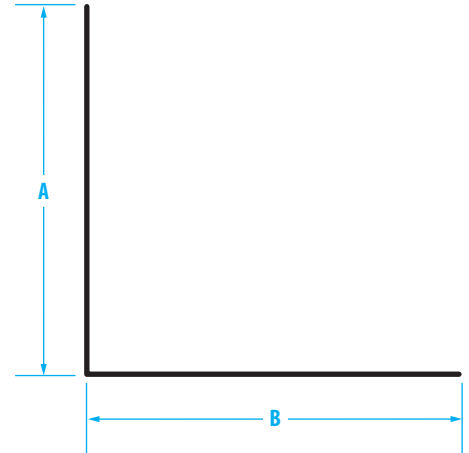

Galvalume Angle Flashing - 26 Gauge

Size - A x B	Description	Part #
4 in. x 5 in.	Angle Flashing 26 Gauge Galvalume	23167
4 in. x 6 in.	Angle Flashing 26 Gauge Galvalume	23352
5 in. x 7 in.	Angle Flashing 26 Gauge Galvalume	40266

Aluminum Angle Flashing

Size - A x B	Description	Part #
5 in. x 5 in.	0.032 Aluminum	10084

Hemmed Galvanized Angle Flashing - 1/2 in. Hem

Size - A x B	ST Gauge	HT Gauge	26 Gauge
4 in. x 3 in.	-	10176	10102
4 in. x 4 in.	10170	-	10106
5 in. x 4 in.	-	-	10122
5 in. x 5 in.	10198	-	-
6 in. x 5 in.	10212	-	10130

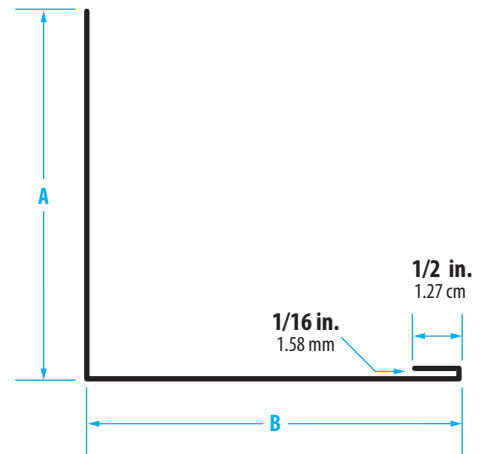

Painted Galvanized Angle Flashing - 1/2 in. Hem

Size - A x B	Description	Part #
4 in. x 3-1/2 in.	ST Gauge Galvanized - Black	10125
4 in. x 9 in.	26 Gauge Galvanized - Black	10221

Painted Aluminum Angle Flashing - 1/2 in. Hem

Size - A x B	Description	Part #
5 in. x 4 in.	0.025 Aluminum - Weathered Wood	10205



Apron/Dormer Flashing Protects roofing from water damage at Roof-to-Wall connections and dormers. 10 ft. Lengths · 20 Pieces per bundle

Apron/Dormer Flashing - Mill Finish

Description	Part #
4-5/16 in. x 2-3/4 in. - ST Gauge - 7 1/2	11905
4-5/16 in. x 2-3/4 in. - 26 Gauge - 7 1/2	11889
4-5/16 in. x 3-1/4 in. - ST Gauge - 8	10866

Apron/Dormer Flashing - Painted

Description	Part #
4-5/16 in. x 4-1/4 in. - ST Gauge - Brown - 9	11925
4-5/16 in. x 4-1/4 in. - ST Gauge - Black - 9	98261

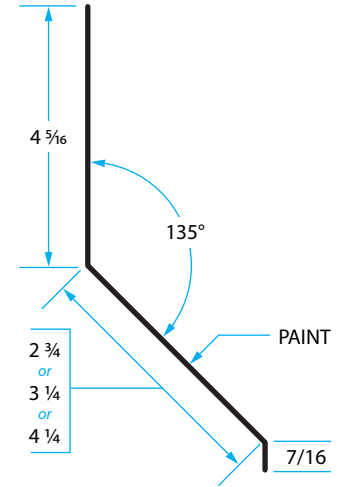

Bullet Boot is a one piece flexible rubber flashing that installs directly over standard PVC vent pipes.

Size	Black	Brown	White	Gray	Weathered Wood	QTY
1 1/2 in.	23221	23220	23222	23223	23236	16
2 in.	23225	23224	23226	23227	23237	16
3 in.	23229	23228	23230	23231	23238	16
4 in.	23233	23232	-	-	23239	8



Drip Edge Applied to the eave and rake to direct water away from the structure. 10 ft. Lengths · 10 Pieces per bundle

Galvanized Drip Edge

Size: A x B	24 Gauge	26 Gauge	HT Gauge	ST Gauge
1-1/4 in. x 1-1/2 in.	-	15421	15539	15531
1-3/4 in. x 2 in.	-	15431	-	15541
2-3/4 in. x 2 in.	-	50021	-	-
2-1/4 in. x 2-1/2 in.	-	15453	-	-
3-3/4 in. x 2 in.	-	15459	-	15555
2-3/4 in. x 3 in.	-	15455	-	15553
3-3/4 in. x 4 in.	23290	15471	-	15562

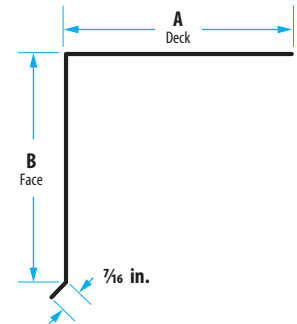

Painted Galvanized Drip Edge

Size: A x B	White	Black	Beige	Brown	Gray
1-3/4 in. x 2 in. - ST Ga.	15587	-	-	-	-
1-3/4 in. x 2 in. - 26 Ga.	15591	-	-	50050	-
1-5/8 in. x 2-1/2 in. - 26 Ga.	15589	-	-	-	-
3-3/4 in. x 2 in. - ST Ga.	99019	-	-	-	-
2-3/4 in. x 3 in. - ST Ga.	15593	-	-	-	-
2-3/4 in. x 3 in. - 26 Ga.	15595	15502	15524	15507	15523

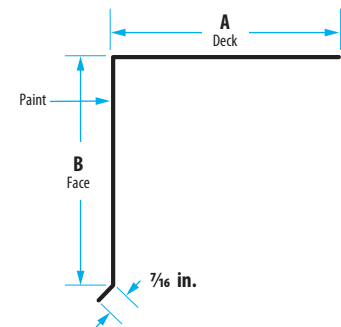

Galvalume Drip Edge

Size: A x B	Mill	-	-	-	-
1-3/4 in. x 2 in. - 26 Ga.	15439	-	-	-	-
2-3/4 in. x 3 in. - ST Ga.	15463	-	-	-	-

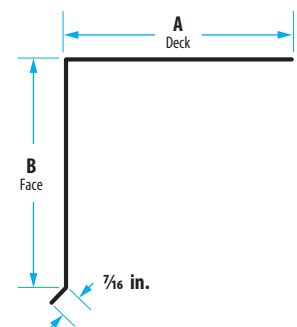

Painted Aluminum Drip Edge

Size: A x B	White	-	-	-	-
1-3/4 in. x 2 in. - ST Ga.	15565	-	-	-	-
1-3/4 in. x 2 in. - 26 Ga.	15569	-	-	-	-
3-3/4 in. x 2 in. - ST Ga.	26577	-	-	-	-

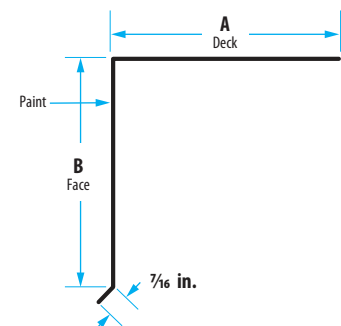

Eave Drip Applied to the eave and rake to support shingles and direct water away from the structure. 10 ft. Lengths - 10 Pieces per bundle

Galvanized Eave Drip

Size: A x B	26 Gauge	ST Gauge	HT Gauge
1-1/2 in. x 1 in. with 1/2 in. OH	-	-	11330
1-5/8 in. x 1-1/4 in.	-	11316	18612
1-3/4 in. x 1-1/8 in.	-	11324	11322
1-11/16 in. x 1-1/4 in.	11020	-	-
2 in. x 1-1/2 in.	-	11340	-
2-1/16 in. x 1-1/2 in.	11040	-	-
2 in. x 2-1/2 in.	-	11352	-
2-3/4 in. x 1-3/4 in.	-	11356	-
2-13/16 in. x 1-3/4 in.	11056	-	-
2-1/16 in. x 2-1/2 in.	11048	-	-
3-3/8 in. x 1-1/8 in.	-	11358	-

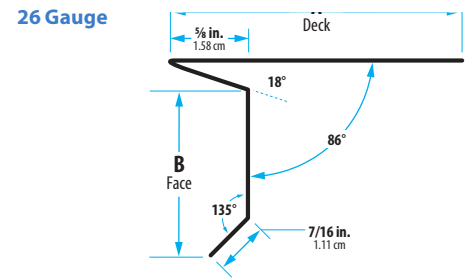
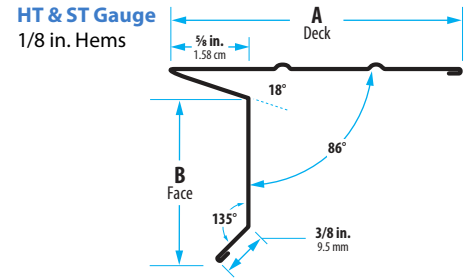

Painted Galvanized Eave Drip - ST Gauge

Size: A x B	Black	Brown	W'Wood	White
1-5/8 in. x 1-1/4 in.	11256	11220	-	11419
1-3/4 in. x 1-1/8 in.	-	-	-	11430
2 in. x 1-1/4 in.	-	-	11259	-
2 in. x 1-1/2 in.	-	-	-	11436
2-3/4 in. x 1-3/4 in.	-	11240	11261	11448
3-3/8 in. x 1-1/8 in.	11266	11238	-	11446

Painted Galvanized Eave Drip - 26 Gauge

Size: A x B	Black	Beige	Brown	Gray	Green	White
1-11/16 in. x 1-1/4 in.	-	-	-	-	-	11426
2-1/16 in. x 1-1/2 in.	-	-	11232	-	-	11442
2-1/16 in. x 2-1/2 in.	11264	11214	11244	11290	11068	11454
2-13/16 in. x 1-3/4 in.	-	-	-	-	-	11054
3-1/16 in. x 1-1/2 in.	-	99489	11050	-	-	11052

Galvalume Eave Drip - 26 Gauge

Size: A x B	Mill	-	-	-	-
2-1/16 in. x 2-1/2 in.	11062	-	-	-	-



Aluminum Eave Drip - ST Gauge

Size: A x B	Mill	Black	Brown	Clay	White
1-1/2 in. x 1 in.	11294	-	11168	11274	11368
1-5/8 in. x 1-1/4 in.	11296	11250	11170	-	11370
2 in. x 1-1/2 in.	-	11889	11188	11276	11390
2 in. x 2-1/2 in.	-	-	-	-	11396
2-3/8 in. x 1-1/8 in.	-	52003	52002	-	52001
2-3/4 in. x 1-3/4 in.	-	11405	-	-	11402
3-3/8 in. x 1-1/8 in.	-	99540	99539	99054	99534

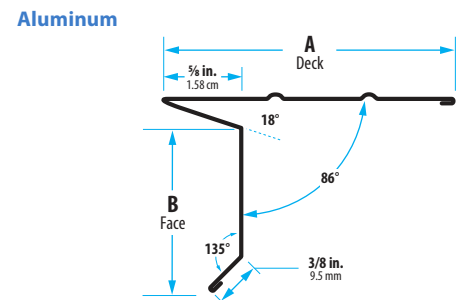

Formed Valley Used in open valley installations to protect against water infiltration. 10 ft. lengths, 10 pieces per bundle, 100 pieces per pallet

18 in. Valley

Description	Mill	Black	Brown
18 in. - No Hem	12037	-	-

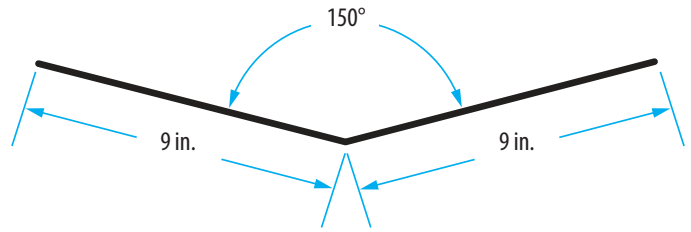

18 in. W-Valley

Description	Mill	Black	Brown
18 in. - ST Gauge - Hemmed	-	14898	-
18 in. - 26 Gauge - Hemmed	14868	14897	99175

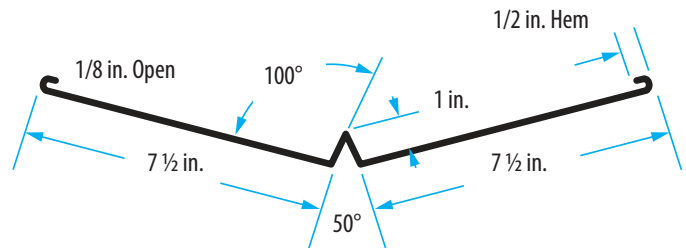

Ridge Roll Flashing for hip and ridge roof sections. For shingle or metal roofing applications. 10 ft. lengths, 10 pieces per bundle, 100 pieces per pallet

Description	Galvanized - ST Ga.
10 in. Ridge Roll	15648
12 in. Ridge Roll	15652
14 in. Ridge Roll	15654
10 in. Ridge Roll - 2-1/2 in. Corrugated	15636

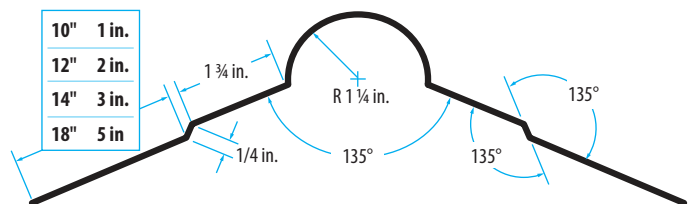

Water Diverter Directs rain water run-off away from entrances and other structures. Galvanized Steel. • 10 ft. lengths • 20 pieces per carton

Description	Mill	Black	Brown
5 in. Water Diverter - 26 Gauge - 7 1/2	17676	-	-
5 in. Water Diverter - ST Gauge - 7 1/2	17690	17684	17688

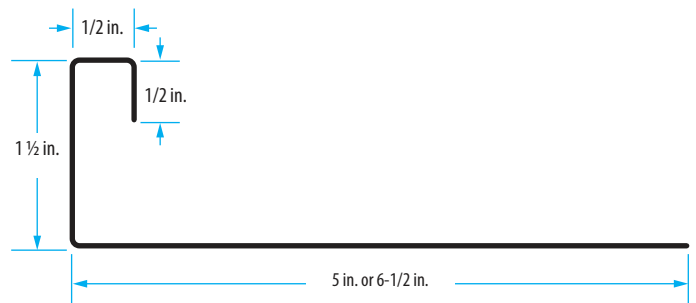

Stucco Flashing Used as a stucco stop to separate wallboard siding or stucco. 25 pieces per carton, 500 pieces per pallet

Description	26 Ga. Galvanized	26 Ga. Galvalume
Stucco Flashing	16017	99340
Stucco Flashing + Extra Bend	16019	99341

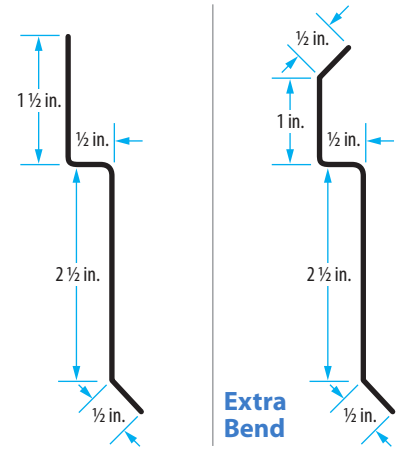

Z-Flashing Protects top edge of siding sheets from water infiltration. 10 ft. lengths • 50 pieces per bundle

Size: A x B x C	HT Galvanized	26 Ga. Galvanized	26 Ga. Galvalume
2 in. x 3/8 in. x 5/8 in.	17837	-	-
2 in. x 5/8 in. x 3/8 in.	17845	17807	17808

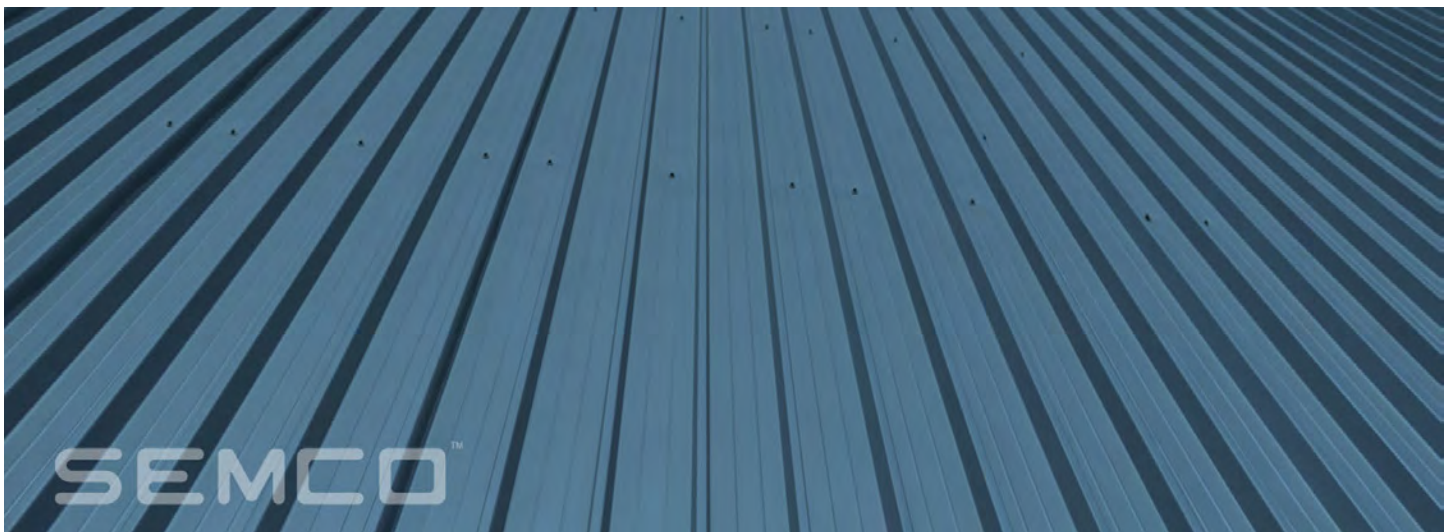
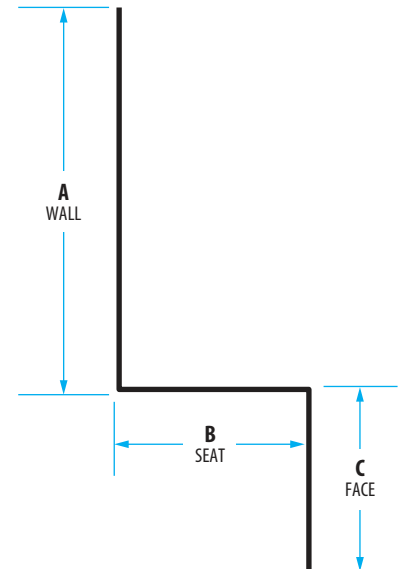

Step Flashing Step flashing is installed where shingled roofing meets the vertical wall or chimney. 1000 pieces per carton, 10,000 pieces per pallet

Aluminum Step Flashing

Description	EC Gauge	ST Gauge
Flat - 5 in. x 7 in. - Mill	-	11956
3 in. x 4 in. x 7 in. - Black	98225	-

Aluminum Step Flashing - CONTRACTOR PACKS

Description	Part #	Qty.
3 in. x 4 in. x 7 in. - EC Gauge - Black	99431	10,000
4 in. x 2 in. x 8 in. - ST Gauge - Black	11993	10,000
4 in. x 4 in. x 8 in. - ST Gauge - Black	11997	10,000
4 in. x 4 in. x 8 in. - HT Gauge - Mill	99162	10,000

Galvanized Steel Step Flashing

Description	HT Gauge	26 Gauge
2 in. x 3 in. x 7 in. - Mill	11998	-
3 in. x 4 in. x 7 in. - Mill	12008	-
4 in. x 4 in. x 7 in. - Mill	12016	-
4 in. x 4 in. x 8 in. - Mill	12020	-
4 in. x 4 in. x 8 in. - Weathered Wood - ST Gauge		18912

Flat Sheet Metal is available in various thicknesses and widths and can be used as a flashing or for DIY projects 1 piece per carton, 1,000 pieces per pallet

Galvanized Steel Flat Sheets

Description	Part #
27.5 in. x 10 ft. - 26 Gauge - Mill	70020
36 in. x 4 ft. - 26 Gauge - Mill	16287
47.25 in. x 10 ft. - 26 Gauge - Black	16306
48 in. x 10 ft. - 26 Gauge - Mill	16303

Galvalume Flat Sheets

Description	Part #
27.5 in. x 10 ft. - 26 Gauge - Mill	16271
27.5 in. x 10 ft. - 24 Gauge - Mill	16251
42 in. x 10 ft. - 26 Gauge - Mill	16342
42 in. x 10 ft. - 24 Gauge - Mill	16253
48 in. x 10 ft. - 26 Gauge - Mill	16341

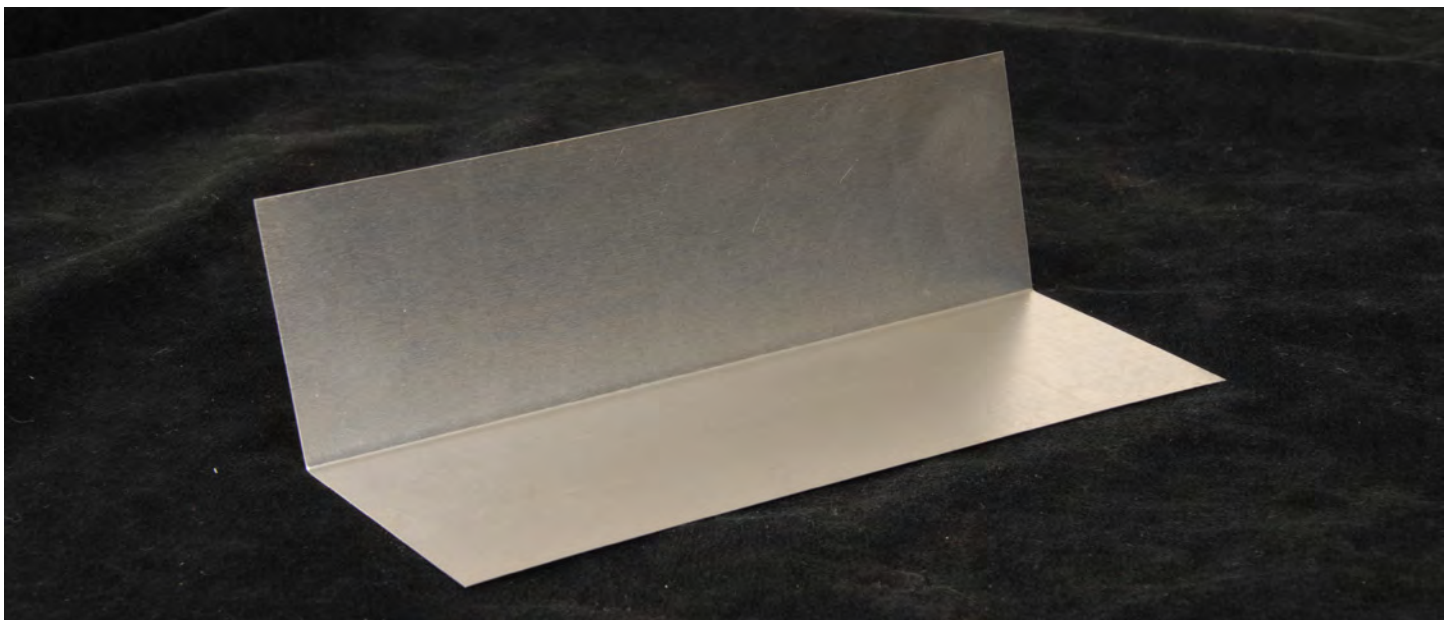

Roll Flashing Multi-use product for fabricating flashings and many other do-it-yourself projects. Rolls sold individually.

Galvanized Roll Flashing

Description	HT Gauge	26 Gauge
6 in. x 50 ft.	17471	-
8 in. x 50 ft.	17479	-
10 in. x 10 ft.	17404	-
10 in. x 50 ft.	17403	-
12 in. x 50 ft.	17412	-
14 in. x 10 ft.	17420	-
14 in. x 50 ft.	17419	-
16 in. x 25 ft.	-	17232
16 in. x 50 ft.	17425	17222
18 in. x 50 ft.	17431	17223
20 in. x 10 ft.	17439	-
20 in. x 25 ft.	17441	-
20 in. x 50 ft.	17438	-
24 in. x 25 ft.	17449	-
24 in. x 50 ft.	17446	-

Aluminum Roll Flashing - EC Gauge

Description	Part#
8 in. x 50 ft.	17390
10 in. x 10 ft.	17275
10 in. x 25 ft.	17277
10 in. x 50 ft.	17208
12 in. x 50 ft.	17290
14 in. x 10 ft.	17306
14 in. x 50 ft.	17210
16 in. x 50 ft.	17318
20 in. x 10 ft.	17339
20 in. x 50 ft.	17212
24 in. x 50 ft.	17352
16 in. x 50 ft. - 0.024	20766

Painted Aluminum Roll Flashing

Description	Color	Part#
10 in. x 10 ft. - 0.013	White/Brown	17191
10 in. x 50 ft. - EC	Black	98223

Galvalume Roll Flashing - 26 Gauge

Description	Part#
16 in. x 50 ft.	60000



Gooseneck Vents Sheltered internal air dampers provides one-way air venting with damper. Often used for kitchen or bath exhaust. Self flashing flanges make for easy installation on new or existing construction.

26 Gauge Galvanized Steel Gooseneck Vents

Description	Mill	White	Brown	Black	N.F.A.	QTY
4 in. - With Damper	17615	17640	17592	60027	12	12
10 in. - With Damper	22999	17644	17596	17605	30	6



26 Gauge Galvalume Steel Gooseneck Vents

Description	Standard	QTY	Tile	QTY
4 in. - With Damper - N.F.A.: 12 sq. in.	60011	12	60566	6
6 in. - With Damper - N.F.A.: 18 sq. in.	60635	6	98302	4
10 in. - With Damper - N.F.A.: 30 sq. in.	60010	6	98301	4

Weather Vent™ Screened external wind baffle provides superior air flow with maximum weather protection. U.S. Patent Number: 7,044,852 B2 • Miami Dade approved, NOA Number 03-1008.02

Weather Vent™ - 26 Gauge Off Ridge Vent

Length	Galvanized	Galvalume	White	Brown	Black	N.F.A.	QTY
2 foot	-	-	-	-	80004	52	1
4 foot	63000	60014	63003	63002	63001	105	1
6 foot	-	-	-	17594	17603	156	2
8 foot	-	-	-	-	17604	207	2

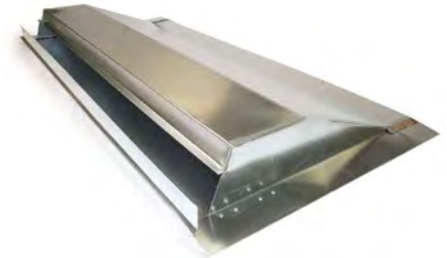

Weather Vent™ - 26 Gauge Off Ridge Tile Vent

Length	Galvalume	White	Brown	Black	N.F.A.	QTY
4 foot - Tile - With Baffle	63130				105	1
4 foot - Tile - Without Baffle	60094				105	1
8 foot - Tile	60028	-	-	-	225	2



Total JACK™ The only roof jack with an adjustable stack and base. Adjusts to fit most roof pitches. US Patents #8,534,013 B3 and #8,615,943 B2.

Size	Mill	Black	Brown	Weathered Wood	QTY
6 inch	JACK6GZ	JACK6BLK	JACK6BRN	JACK6WWD	7
8 inch	JACK8GZ	JACK8BLK	JACK8BRN	JACK8WWD	6

Galvanized steel in accordance to ASTM A924/A653
Base Thickness: Galvanized 0.016 in. / Painted 0.019 in.
Stack Thickness: Galvanized 0.012 in. / Painted .013 in.
Cap Thickness: Galvanized 0.012 in. / Painted 0.013 in.



Universal Ridge Vent - Aluminum Removes superheated attic air. Self-flashing. Can be installed on new or existing construction. Embossed Aluminum. 10 ft. lengths.

Description	Black	Brown	Bronze	Gray	White	QTY
10 ft. Universal Ridge Vent	84403	84405	84406	84402	84399	12
End Plug/Connector - Rubber	84426	-	-	-	-	12
End Plug/Connector - Foam	40237	-	-	-	-	24

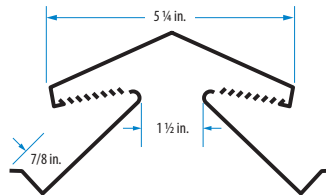

RV-10
N.F.A.
16 sq. in./ft.

Clean Mesh® Advanced gutter protection system. Stainless steel micro mesh is effective against small debris, including pine needles, seed pods and shingle grit. Fascia mount for 5 in. or 6 in. K-Style gutters. Available in 3 and 4 ft. lengths. Patent: 8,474,192



Screen Mesh® Advanced gutter protection system. Durable aluminum construction with stainless steel micro mesh Under shingle mount for 5 in. or 6 in. Super Gutters, Box Gutters and K-Style gutters. Available in 4 and 5 ft. lengths. Patent: 8,474,192



Gutter Helmet® The Nose Forward Design extends to the edge of the gutter, eliminating all vertical openings. Gutter Helmet's patented Textured/Ribbed Surface increases rain handling capabilities, tensile strength and is more attractive than flat panel knock-off's. Gutter Helmet® includes a PermaLife™ coating that will not chalk or fade. Engineered to last a lifetime, Gutter Helmet® installs over new or existing gutters. Only Gutter Helmet® can rightfully say you will Never Clean Your Gutters Again!®

Gutter Helmet® can only be purchased through and installed by factory-trained and certified dealers. Every installation includes a careful assessment of your roof, gutters and fascia boards as well as gutter tune-up and realignment.



J-Bead A channel-type trim that provides a neat protective edge for wallboard at windows and doors. Widely used as a terminal at intersections of wallboard and other surfaces

Description	Part #	Carton	Pallet
1/2 in. x 10 ft. - Galvanized Steel J-Bead	12839	50	2,450
1/2 in. x 10 ft. - Vinyl J-Bead	70083	50	2,400
5/8 in. x 10 ft. - Vinyl J-Bead	70084	50	2,400

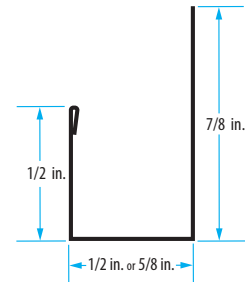

L-Bead An angle-type trim provides a finished appearance for wallboard edges at door and window openings. Hemmed edge. Nailing flange is knurled and perforated to aid compound adhesion

Description	Part #	Carton	Pallet
1/2 in. x 10 ft. - Vinyl L-Bead	70085	80	3,840
1/2 in. x 10 ft. - Vinyl Zip L-Bead	70082	50	2,400
1/2 in. x 10 ft. - Galvanized Steel L-Bead	13039	50	2,400

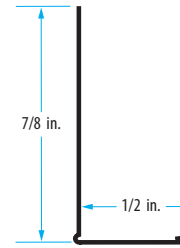

Corner Bead Strong, durable and straight reinforcement for drywall and veneer plaster corners.

Description	Part #	Carton	Pallet
1-1/4 in. x 8 ft. - Vinyl Corner Bead	10518	50	2,500
1-1/4 in. x 10 ft. - Vinyl Corner Bead	10512	50	2,500
1-1/4 in. x 8 ft. - Galvanized Steel Corner Bead	10530	63	3,087
1-1/4 in. x 9 ft. - Galvanized Steel Corner Bead	10532	56	2,744
1-1/4 in. x 10 ft. - Galvanized Steel Corner Bead	10524	50	2,450
8 ft. - Superwide Paper-Faced Corner Bead	70086	50	2,800
10 ft. - Superwide Paper-Faced Corner Bead	70087	50	2,800
10 ft. - Superwide Paper-Faced Inside Corner	70088	50	2,800
8 ft. - Big Stick Composite Corner Bead	BS3008	50	1,200
10 ft. - Big Stick Composite Corner Bead	BS30010	50	1,200

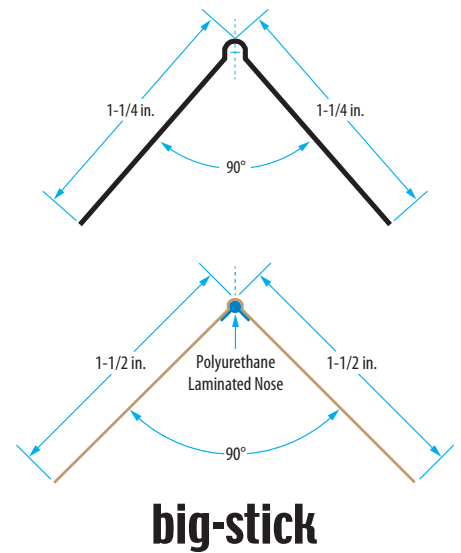

Bullnose Corner Bead Provides an architecturally attractive corner that is both durable and straight on exposed edges of wallboard.

Description	Part #	Carton	Pallet
10 ft. - Vinyl Bullnose Corner Bead	10514	35	1,750
10 ft. - Galvanized Steel Corner Bead	10505	40	1,600

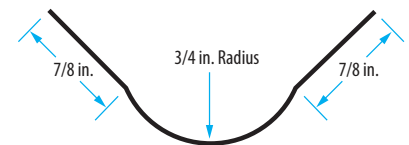

Arched Vinyl Corner Bead Pre-notched to form curves easily. Improved slots for better radius.

Description	Part #	Carton	Pallet
1-1/4 in. x 10 ft. - Arched Vinyl Corner Bead	10513	50	2500
10 ft. - Arched Vinyl Bullnose Corner Bead	70081	50	nso
10 ft. - Composite Arch Stick	ASIO	25	600

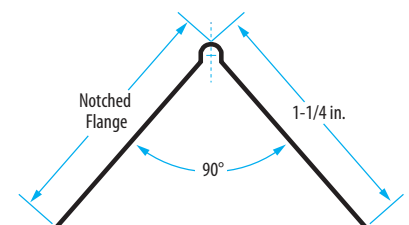

H-Moulding Used to splice butt joints of plywood soffit systems. Material: Aluminum Extrusion

Description	Part #	QTY.
3/8 in. x 12 ft. Aluminum H-Moulding	12754	50

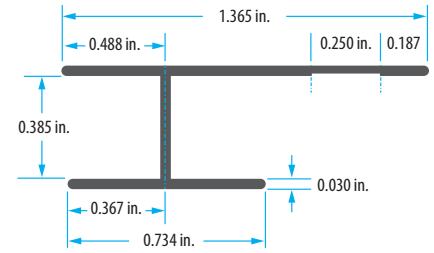

Insulation Support Wire A quick and economical way to hold insulation in place between studs and joist. Materials: 13 Gauge Galvanized Steel

Description	Part #	QTY.
16 in. Insulation Support Wire	34015	500
24 in. Insulation Support Wire	34016	500

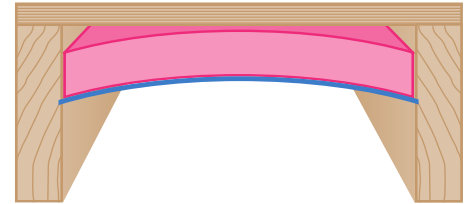

Mobile Home Skirting Embossed galvanized steel panels in a convenient size. The panels can be attached to a simple frame for mobile home skirting or utilized as a decorative wall covering.

Description	Part #	Bundle	Pallet
26 Gauge Galvanized Steel - 28 in. x 60 in.	13174	10	500



Termite Shield Provides a moisture & termite barrier for wood sill-to-concrete contact.

Description	Gauge	Part #	Bundle
4 in. x 2 in. x 10 ft. - Termite Shield	28	17049	20
8 in. x 2 in. x 10 ft. - Termite Shield	ST	17043	20

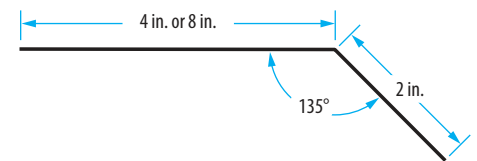

Casing Bead Creates a flush stucco stop for framed doors, windows, and other openings. A ridge of nail holes provides for easy installation.

Description	Part#	Carton	Pallet
1/2 in. x 10 ft. Galvanized Steel Casing Bead	10521	30	1,200
3/4 in. x 10 ft. Galvanized Steel Casing Bead	10522	30	600
3/4 in. x 10 ft. Vinyl Stucco Casing Bead	10517	75	1,875



Expanded Outside Corner Bead Expanded diamond mesh wings allow for keying the plaster right up to the nose of the bead. Provides plumb reinforcement at corners.

Description	Part#	Carton	Pallet
8 ft. Galvanized Steel Outside Expansion Bead	10508	40	800
10 ft. Galvanized Steel Outside Expansion Bead	10507	30	900



Expanded Inside Corner Bead Finished edge corner lath provide reinforcement for plastered inner corners. Preshaped to 105° for a snug fit in 90° corners with wings tight against the plaster base.

Description	Part#	Carton	Pallet
3 in. x 3 in. x 8 ft. Galvanized Steel Inside Corner Bead	10509	75	1,500
3 in. x 3 in. x 10 ft. Galvanized Steel Inside Corner Bead	10521	30	1,200

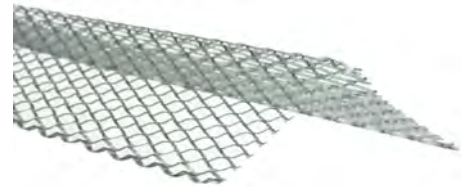

Galvanized Kal-Korner Galvanized steel to protect exterior corners with veneer plastering. Flanges: 1-1/4 in.

Description	Part#	Carton	Pallet
1-1/4 in. x 1-1/4 in. x 8 ft. Galvanized Steel Corner Bead	99465	80	2,240
1-1/4 in. x 1-1/4 in. x 10 ft. Galvanized Steel Corner Bead	10510	60	1,680



Vinyl Casing Bead Utilized to terminate stucco.

Description	Part#	Carton	Pallet
1/2 in. x 10 ft. Vinyl Casing Bead	10516	100	2500

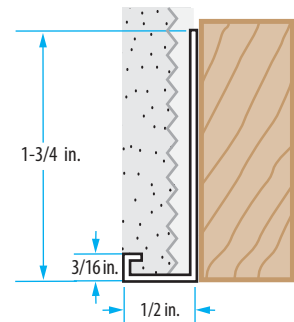

Vinyl Corner Bead Reinforces exterior corners with durable and straight corners.

Description	Part#	Carton	Pallet
1-1/4 in. x 1-1/4 in. 10 ft. Vinyl Corner Bead	10515	50	1250



Diamond Steel Framing™ Stud Featuring embossed chevrons to increase strength and provide proper orientation during installation. Stiffening ribs provide additional strength and rigidity. Deep knurling allows for secure screw connections. 25 Gauge Galvanized Steel.



Description	Part#	Bundle	Pallet
1-5/8 in. x 8 ft. Diamond Steel Framing Stud	15964	10	180
1-5/8 in. x 10 ft. Diamond Steel Framing Stud	15962	10	180
2-1/2 in. x 8 ft. Diamond Steel Framing Stud	15968	10	240
2-1/2 in. x 10 ft. Diamond Steel Framing Stud	15966	10	240
3-5/8 in. x 8 ft. Diamond Steel Framing Stud	15978	10	180
3-5/8 in. x 10 ft. Diamond Steel Framing Stud	15970	10	180
3-5/8 in. x 12 ft. Diamond Steel Framing Stud	15972	10	180

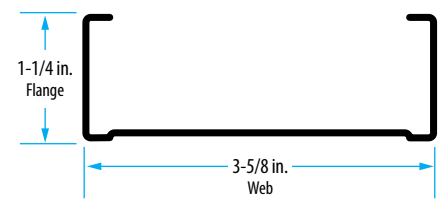
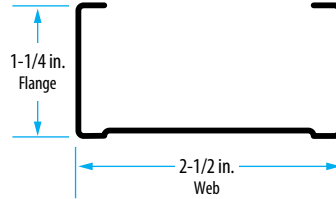
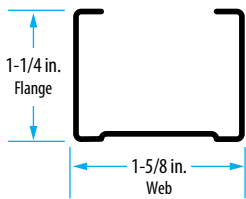

Diamond Steel Framing™ Track Track is used to anchor the partition at floor and ceiling. Channel configuration formed with unhemmed legs sized to receive the corresponding size stud. 25 Gauge Galvanized Steel.

Description	Part#	Bundle	Pallet
1-5/8 in. x 10 ft. Diamond Steel Framing Track	17036	10	180
2-1/2 in. x 10 ft. Diamond Steel Framing Track	17038	10	240
3-5/8 in. x 10 ft. Diamond Steel Framing Track	17040	10	180

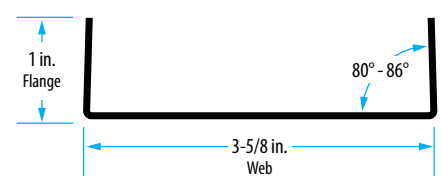
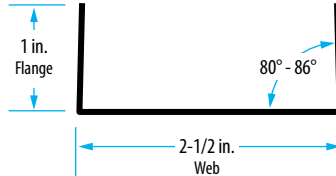
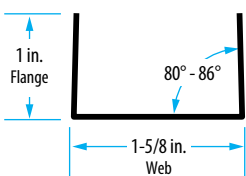
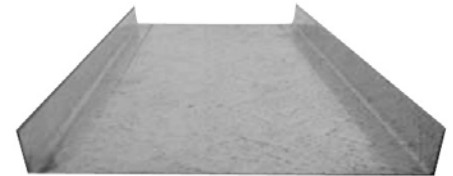

Track flanges are "toed" in to provide a friction grip on the stud.

Furring Channel also known as Hat Channel, is a corrosion-resistant framing component used to level uneven surfaces prior to applying drywall sheets to walls and ceilings. 25 Gauge Galvanized Steel.

Description	Part#	Bundle	Pallet
7/8 in. x 12 ft. High Hat Furring Channel	13194	10	500

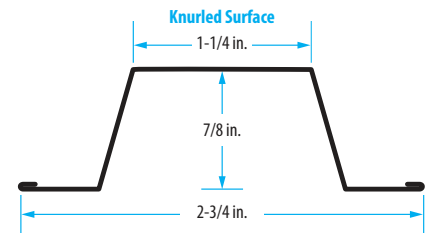

Rooftop Safety Kit Provides the basic safety tools for OSHA Compliance.

- Universal full body harness
- No tangle vertical lifeline assembly with a swivel snap hook, and integrated shock absorber
- Permanent positioning device with an 18 inch lanyard extension to help keep the device within reach
- 1 Heavy Duty tempered reusable anchor.
- 3-1/2 gallon bucket

Description	Part#	QTY
Rooftop Fall Protection Kit	00875-QC	1



Roof Anchors

Reusable Temper Roof Anchor

00455-QC
QTY: 10

Fasteners included



Permanent Double D Roof Anchor For permanent use on wood roofs

00510-QC
QTY: 10



Description	Part#	QTY
Reusable Roof Anchors - Fasteners included	00455-QC	10
Permanent Roof Anchors	00510-QC	10

Lanyard

6 ft. Shock Absorbing Lanyard

01220-QC
QTY: 6



Description	Part#	QTY
6 ft. Shock Absorbing Lanyard	01220-QC	6

Universal Fit Harness

Seraph Universal Fit Harness

11160-QC
QTY: 5



Description	Part#	QTY
Seraph Universal Harness	11160-QC	5

50 ft. Lifeline

Heavy duty poly rope resists cuts, abrasions and water absorption. Attached self locking carabiner

99422
QTY: 4



Description	Part#	QTY
50 ft. Lifeline	99422	4

5V Crimp Panels	3	Metal Roof Flashings.....	6
50 ft. Lifeline	22	Mobile Home Skirting	19
Angle Flashing	8	Off Ridge Vent	16
Apron Flashing	9	PBR Panels	4
Arched Vinyl Corner Bead	18	Ridge Roll	12
Bullet Boot	9	Ridge Vent, Universal	17
Bullnose Corner Bead	18	Roll Flashing	15
Casing Bead, Stucco	20	Roof Anchors.....	22
Clean Mesh®	17	Rooftop Safety Kit.....	22
Corrugated Panels	3	R Panels	4
Dormer Flashing	9	Screen Mesh®	17
Drip Edge	10	SEMCO Colors	4
Drywall Corner Bead	18	Sem-Lok™ Panels	5
Eave Drip	11	Shock Absorbing Lanyard	22
Expanded Inside Corner Bead, Stucco	20	SM-Rib Panels	5
Expanded Outside Corner Bead, Stucco.....	20	Standing Seam	5
Exposed Fastener	3	Steel Framing	21
Flat Sheet Metal	14	Step Flashing	14
Formed Valley	12	Stucco Flashing	13
Furring Channel	21	Termite Shield	19
Galvanized Corner Bead, Stucco.....	20	Total JACK™	16
Gooseneck Vents	16	Universal Fit Harness	22
Gutter Helmet®.....	17	Vinyl Casing Bead, Stucco	20
Hat Channel	21	Vinyl Corner Bead, Stucco	20
H-Molding	19	Water Diverter	12
Insulation Support Wire.....	19	Weather Vent™	16
J-Bead, Drywall	18	W-Valley	12
L-Bead, Drywall	18	Z-Flashing	13





PRODUCT CATALOG

Trims & Flashing
Metal Roofing
Ventilation
Drywall Bead
Stucco & Plaster
Soffit & Fascia
Steel Framing
Gutter Protection
Safety Products

GIBRALTAR
INDUSTRIES

www.gibraltarbuildingproducts.com



Focus on Excellence

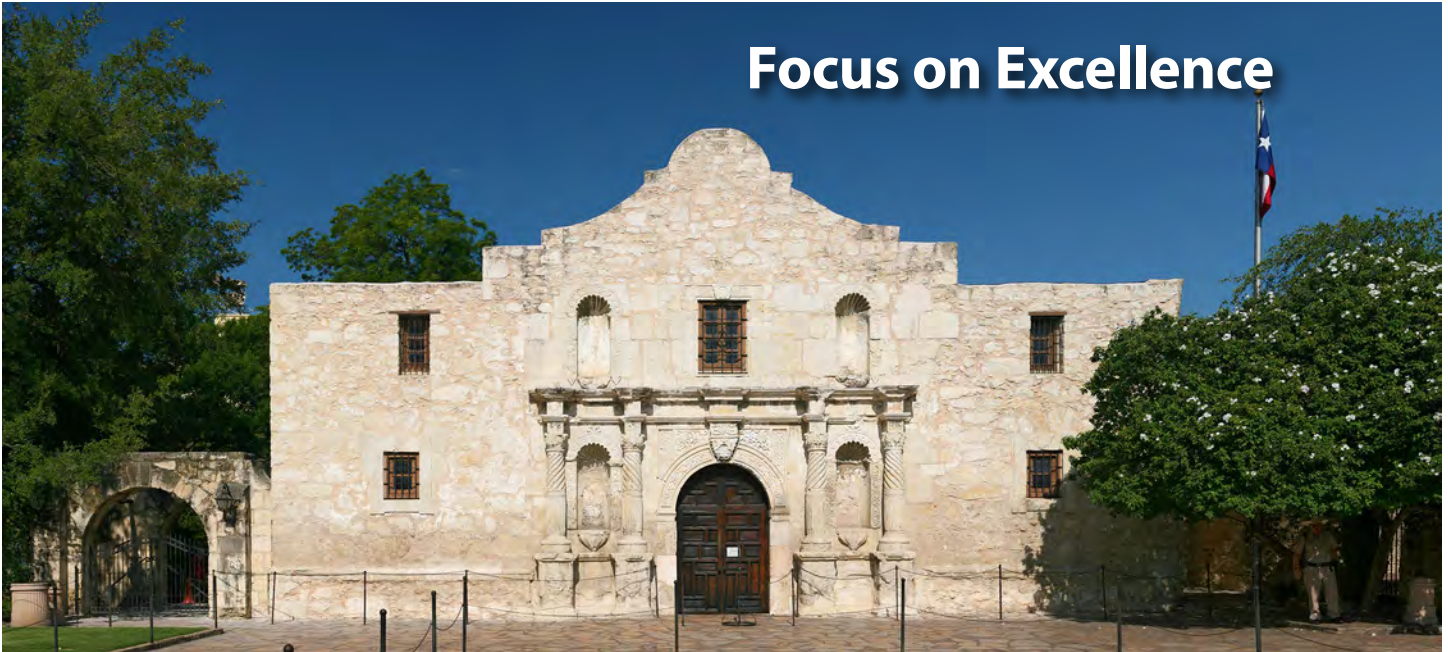

For more than 50 years, DOT Metal's products have been trusted for quality and tested for strength. DOT Metal Products produces over 3,000 galvanized, steel and aluminum building components, specializing in metal roofing, ventilation products, trims, flashing, steel framing, rain carrying products, corner bead and drywall accessories. Every product is precision engineered and manufactured to the highest standards to promote greater strength and durability while enhancing overall structural integrity after installation.

Since the company's foundation in 1958, DOT Metal Products has grown into the region's leading manufacturers of metal building products. In 1997, Gibraltar Industries acquired the company, uniting the quality product line of DOT Metal Products with the nationally respected brand name of Gibraltar. As a member of the Gibraltar Industries family, DOT Metals is part of a network of manufacturers expanding across the globe. With the support and backing of the Gibraltar Building Products Group, DOT Metals will remain the name you can trust for quality metal building products.

DOT Metal's corporate office and manufacturing base is headquartered in San Antonio, Texas with regional manufacturing and distribution in Houston, Texas. Serving Texas, Louisiana, Arkansas, Missouri, Kansas, Oklahoma and New Mexico; over 2,300 locations in the south central United States depend on DOT for their metal product requirements.

DOT Metals' strong focus on excellence means our customers can expect unsurpassed delivery and service of superior products every time they call.

GALVANIZED STEEL

All galvanized steel products are zinc coated as specified by ASTM-A-653, Federal specification AA-S-775 E.

Caution: do not use in contact with copper or pressure treated lumber

ALUMINUM

All aluminum products are as specified by ASTM B-209, Federal specification QQ-A-250 E.

Caution: Avoid direct contact with dissimilar metal and with concrete or mortar.

FINISH

All bare 26 gauge galvanized products have a zinc coating of G-90 for corrosion resistance.

All painted products have a gloss polyester color coating over primer.

CUSTOMER SERVICE: 800-331-9966 • FAX 210-651-0657 • DELIVERIES: 7 TO 10 BUSINESS DAYS

GALVANIZED STEEL

Gauge	Thickness	Max.	Min.	Lbs./Sq. Ft.
20	0.0396	0.0356	0.0436	1.656
22	0.0336	0.0296	0.0376	1.405
24	0.0276	0.0236	0.0316	1.154
26	0.0217	0.0179	0.0247	0.907
28	0.0187	0.0157	0.0217	0.782
29	0.0172	0.0142	0.0202	0.719
30	0.0157	0.0127	0.0187	0.657
ST	0.0120	0.0118	0.0125	0.507
HT	0.0100	0.0098	0.0115	0.408

ALUMINUM

Gauge	Thickness	Max.	Min.	Lbs./Sq. Ft.
20	0.0320	0.0305	0.0365	0.451
22	0.0253	0.0224	0.0284	0.352
24	0.0201	0.0173	0.0234	0.282
26	0.0159	0.0123	0.0183	0.224
28	0.0126	0.0119	0.0132	0.177
29	0.0113	0.0112	0.0122	0.159
30	0.0100	0.0095	0.0115	0.141
ST	0.0145	0.0140	0.0180	0.208
EC	0.0085	0.0078	0.0085	0.123



Table of Contents

METAL ROOFING

5V Crimp	3
Corrugated	4
SM-Rib	4
Metal Roofing Accessories	5

TRIMS & FLASHINGS

Angle Flashing	6
Apron Flashing	6
Turnback Flashing	6
Counter Flashing	7
Drip Cap/Head Flashing	7
Style "A" Drip Edge	8
Style "G" Drip Edge	8
Style "D" Eave Drip	9
Gutter Apron	10
Gravel Guard	10
Modified Roof Edge	10
Roll Flashing	11
Step Flashing	12
Flat Shingles	12
Valley Flashing	12
Water Diverter	13
Z-Flashing	13

PIPE FLASHING

Bullet Boot	14
Adjustable Pipe Boots	14
FHA Pipe Flashing	14

VENTILATION

Gable Louvers	15
Total JACK™	15

GUTTER PROTECTION

Clean Mesh®	16
Screen-Mesh®	16

DRYWALL CORNER BEAD PRODUCTS

Drywall Corner Bead	17
Vinyl Bullnose Corner Bead	17

CONSTRUCTION HARDWARE

Insulation Support Wire	17
H-Moulding	17
Mobile Home Skirting	17

STUCCO AND PLASTER PRODUCTS

Casing Bead	18
Expanded Outside Corner Bead	18
Expanded Inside Corner Bead	18
Metal Lath	18

SAFETY SUPPLIES

Rooftop Safety Kit	19
Roof Brackets	19
Vertical Lifeline	19
Shock Absorbing Lanyard	19
Roof Anchors	19

INDEX	20
-------------	----





Metal Roofing

5V Crimp exposed fastener roofing panel. 24 inch width coverage. Applications: Residential, Agricultural, Architectural, Light Commercial, Industrial

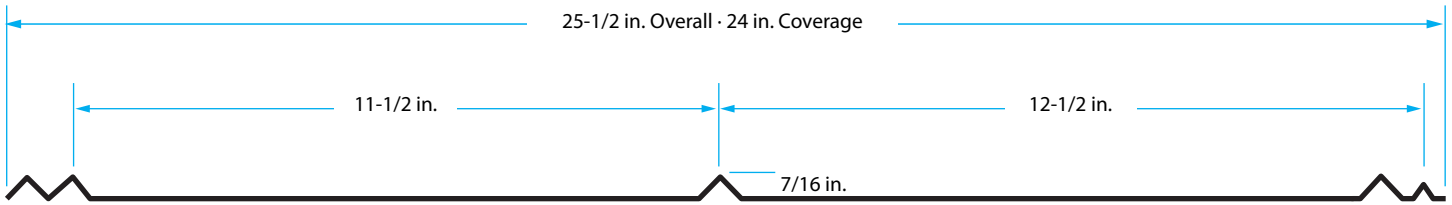

Code Approvals

UL Fire Resistant Directory #R20735
 Miami Dade NOA #: 11-0714.08
 Florida Building #FL-11175

1. For the most recent code approval numbers, contact Southeastern Metals' Technical Department or refer to the appropriate code agency.

Testing Data & Specifications

Accelerated testing 2000 hours - ASTM G23
 Salt Spray testing 1000 hours - ASTM B117
 Fire Testing - ASTM E108 or UL 790
 Wind Driven Rain - TAS 100



Galvanized Steel 5V Crimp Panels

Description	29 Gauge	26 Gauge
8 ft.	13351	13319
10 ft.	13340	13309
12 ft.	13343	-
14 ft.	13345	-
16 ft.	13347	-

G90, conforming to ASTM A446



40 Year Paint Colors

NOTE: Colors shown are for reference only. Actual metal color samples are available upon request.



Barn Red
(SR) 0.35 · (TE) 0.83 · (SRI) 36

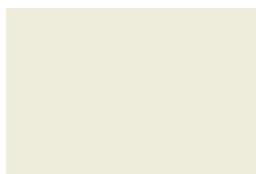

Bone White
(SR) 0.55 · (TE) 0.83 · (SRI) 63



Forest Green
(SR) 0.25 · (TE) 0.83 · (SRI) 22



Light Stone
(SR) 0.55 · (TE) 0.83 · (SRI) 63



Mocha Tan
(SR) 0.32 · (TE) 0.83 · (SRI) 32



Metal Roofing

Corrugated exposed fastener roofing panel. 21-1/2 inch width roofing coverage. 24 inch width siding coverage. Applications: Residential, Agricultural, Architectural, Light Commercial, Industrial

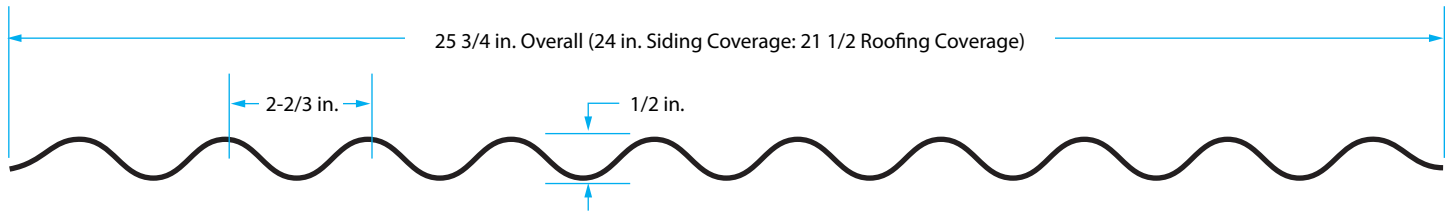

2-1/2 in. Corrugated Metal Roofing Panels - 50 pieces per bundle

Length	32 Gauge	29 Gauge	26 Gauge
6 ft.	13511	07036	-
8 ft.	13513	13478	08129
10 ft.	13504	13473	13458
12 ft.	13506	13474	13459
14 ft.	13508	13475	-
16 ft.	07010	13476	-

G90, conforming to ASTM A446

Code Approvals

UL Listing Directory #R20735
UL Fire Resistant Directory #R20735
Florida Building #FL-11175-R1

1. For the most recent code approval numbers, contact DOT Metals' Technical Department or refer to the appropriate code agency.



SM-Rib exposed fastener siding panel. 36 inch width coverage. Applications: Residential, Agricultural, Light Commercial, Industrial



SM-Rib Metal Roofing Panels

50 pieces per bundle

Length	29 Gauge
8 ft.	13560
10 ft.	13542
12 ft.	13544
16 ft.	13549



Code Approvals

UL Fire Resistant Directory #R20735
Miami Dade: N.O.A. No. 09-0630.11
Florida Building #FL-11175

1. For the most recent code approval numbers, contact DOT Metals' Technical Department or refer to the appropriate code agency.

Testing Data & Specifications

Accelerated testing 2000 hours - ASTM G23
Salt Spray testing 1000 hours - ASTM B117
Fire Testing - ASTM E108 or UL 790
Wind Driven Rain - TAS 100

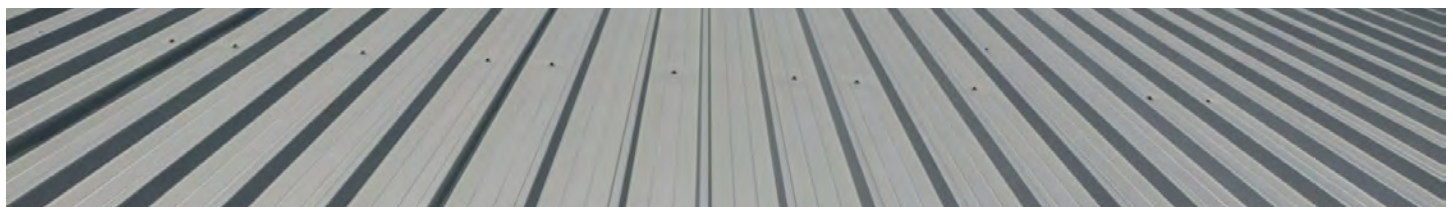
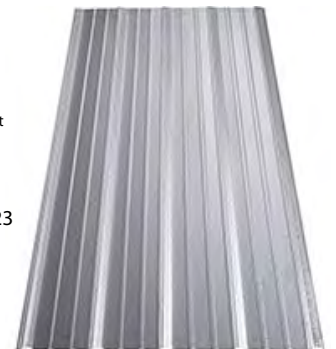



Metal Roofing Accessories

Ridge Roll Flashing for hip and ridge roof sections.
For shingle or metal roof applications. Pack Quantity: 10

Description	Plain	Corrugated
10 in. x 10 ft. Galvanized Steel Ridge Roll	15648	15636
12 in. x 10 ft. Galvanized Steel Ridge Roll	15652	01516

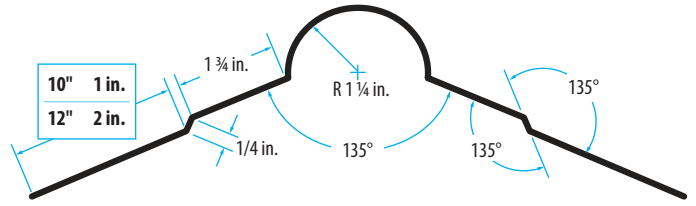

Closure Strips closure strips fill the gap between the roofing panel and the roof deck to keep out insects, vermin and wind-blown rain. Foam closure strips have a self-adhesive backing for ease of installation. 4 strips per bag - Pack Quantity: 25 bags

Description	Part #
2 ft. Corrugated Closure Strip	98957
2 ft. 5V Crimp - Inside Closure Strips	98187
2 ft. 5V Crimp - Outside Closure Strips	98956
3 ft. SM-Rib - Inside Closure Strips	98190
3 ft. SM-Rib - Outside Closure Strips	98191

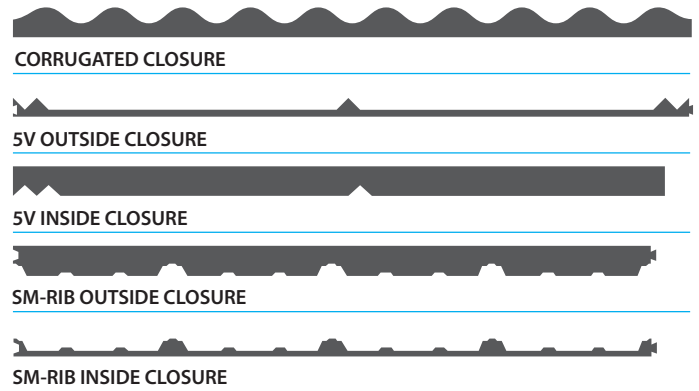

Woodfast Screws Galvanized #9 Hex-Head with integrated neoprene gasket and self-piercing tip.

Description	100/bag	250/bag
#9 x 1-1/2 in. Woodfast Screws	34166	34404



Butyl Tape Sealant commonly used in metal roofing installations to seal metal-to-metal connections. Stays flexible over time providing an effective barrier against moisture.

Description	Part #	QTY
1/2 in. x 45 ft. Rolls	99415	32 Rolls

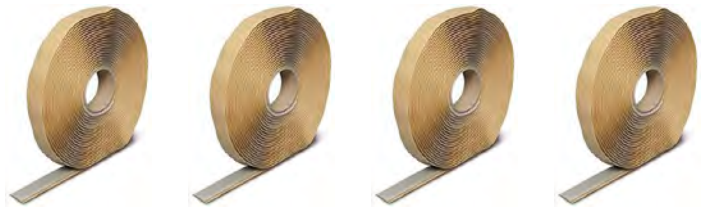



Trims and Flashings

Angle Flashing: Protects against leaks at end wall, sidewall, & tile pan rooftop applications.
Galvanized Steel · 10 ft. lengths · Pack Quantity: 25

Description: A x B	ST Gauge	26 Gauge
3 in. x 3 in.	02027	02028
3 in. x 5 in.	02029	-
4 in. x 4 in.	02031	02044
4 in. x 5 in.	02033	-
4 in. x 5 in. - 120°	02154	-
5 in. x 5 in.	02035	-
6 in. x 6 in.	02041	-
4 in. x 4 in. - Weathered Wood	08398	-

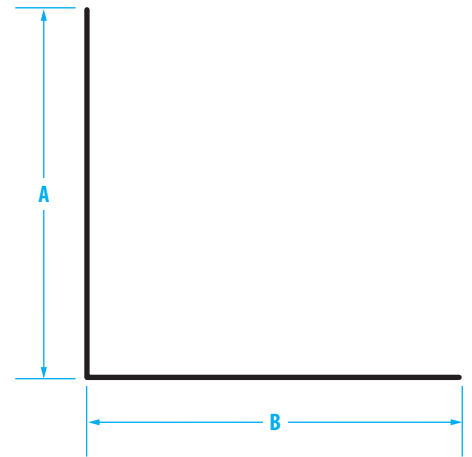

Apron Flashing: Protects against water damage; roof to wall connections, typically beneath a dormer.
26 Gauge Galvanized Steel · 10 ft. lengths · Pack Quantity: 20

Description	26 Gauge
4-5/16 in. x 2-3/4 in. · 26 Gauge Galvanized Steel Apron Flashing	11889

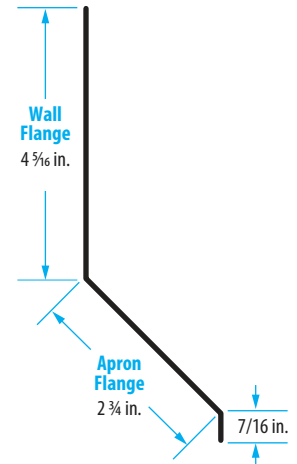

Turnback Flashing: Protects against leaks at end wall, sidewall, & tile pan roof top applications.
10 ft. lengths · Pack: 20 pieces

Description: A x B x C	Item
4 in. x 5 in. x 1/2 in. - HT Gauge	10176
4 in. x 4 in. x 1/2 in. - ST Gauge	02053
4 in. x 4-1/2 in. x 1/2 in. - ST Gauge	02555
6 in. x 5 1/2 in. x 1/2 in. - ST Gauge	02061
6 in. x 11-1/2 in. x 1/2 in. - ST Gauge	02022
10 in. x 10 in. x 1/2 in. - ST Gauge	91010
5 in. x 4-1/2 in. x 1/2 in. - 28 Gauge	02023
4 in. x 4 in. x 1/2 in. - 26 Gauge	07503
5 in. x 4-1/2 in. x 1/2 in. - 26 Gauge	07504

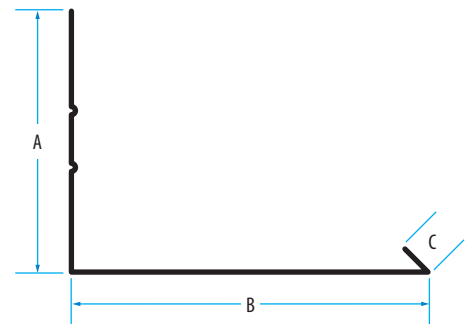



Trims and Flashings

Counter Flashing Directs rain water run-off away from entrances and other structures. 10 ft. lengths · Pack Quantity: 25

Description	Part #
Surface Mount Counter Flashing · 26 Gauge Galvanized Steel	03446
Saw Joint Counter Flashing · 26 Gauge Galvanized Steel	02075
Saw Joint Counter Flashing · 26 Gauge Galvanized Steel	03339
Saw Joint Counter Flashing · 26 Gauge Galvanized Steel · Black	08400
Saw Joint Counter Flashing · 26 Gauge Galvanized Steel · Brown	08386
Saw Joint Counter Flashing · 26 Gauge Galvanized Steel · Weathered Wood	08387

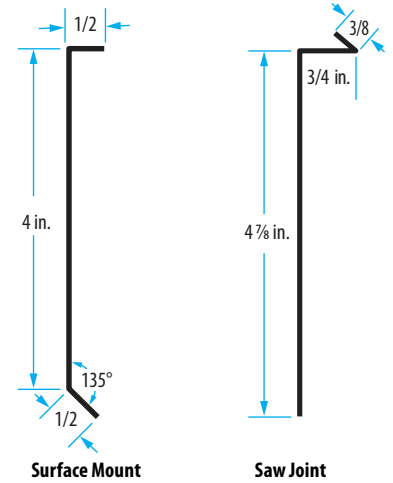

Drip Cap/Head Flashing Protects top edge of doors & windows from water infiltration. 10 ft. lengths

Size: A x B x C	Description	Part #	QTY
1/4 in. x 1 in. x 1-3/4 in.	Standard Gauge Galvanized Steel	90010	50
1/4 in. x 1-1/4 in. x 1-1/2 in.	Standard Gauge Galvanized Steel	90017	50
1/4 in. x 1-3/8 in. x 1-3/8 in.	Standard Gauge Galvanized Steel	10133-1	50
1/4 in. x 1-1/2 in. x 1-1/4 in.	Standard Gauge Galvanized Steel	10112-1	50
1/4 in. x 1-1/2 in. x 2-1/4 in.	Standard Gauge Galvanized Steel	02095	25
1/4 in. x 2 in. x 1-3/4 in.	Standard Gauge Galvanized Steel	02101	25
1/2 in. x 1-1/2 in. x 3 in.	ST Gauge Galvanized Steel - Window Flashing	19801	25
1/2 in. x 1-1/2 in. x 6 in.	ST Gauge Galvanized Steel - Window Flashing	91030	25
1/2 in. x 3-1/2 in. x 2-1/2 in.	ST Gauge Galvanized Steel - Window Flashing	04016	25

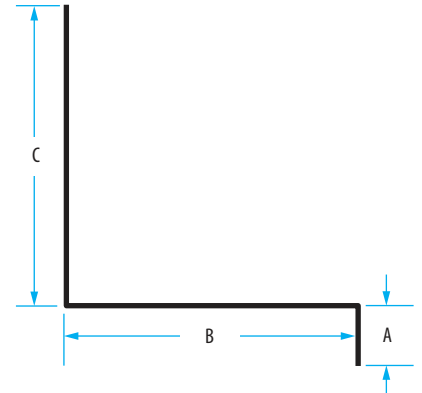



Trims and Flashings

Style "A" Drip Edge Applied to the eave and rake to direct water away from the structure.
10 ft. lengths · Pack Quantity: 25

Size: A x B	HT Gauge	ST Gauge	28 Gauge	26 Gauge
1 in. x 2 in. - 1/8 in. Hem	03336	02802	-	-
2 in. x 2 in. - 1/8 in. Hem	-	02801	90056	01826

Size: A x B	Part #
2 in. x 3 in. ST Gauge Galvanized Steel - Unhemmed	01890
3 in. x 3 in. ST Gauge Galvanized Steel - Unhemmed	01892
4 in. x 4 in. ST Gauge Galvanized Steel - Unhemmed	01896
6 in. x 6 in. 28 Gauge Galvanized Steel - Unhemmed	RE66G

Style "A" Drip Edge Painted - ST Gauge Steel · Smooth · 1/8 in. hem

Size: A x B	Almond	Black	Brown	C. Gray	Tan	White	W.Wood
1 in. x 2 in.	08341	08342	08343	-	-	08349	08348
1-1/2 in. x 1-1/2 in.	08332	08333	08334	08335	08339	08331	08330
2 in. x 2 in.	08354	08355	08356	08357	08360	08361	08353

1-7/8 in. x 1-7/8 in.	ST Gauge Aluminum · Smooth · Hemmed - White	01689
-----------------------	---	-------

3 in. x 3 in.	ST Gauge Steel · Smooth · Unhemmed - Weathered Wood	08397
---------------	---	-------

Style "A" Drip Edge Painted Woodgrain Embossed - ST Gauge Steel · Smooth · 1/8 in. hem

Size: A x B	Almond	Black	Brown	C. Gray	Tan	White	W.Wood
1 in. x 2 in.	-	-	08323	-	-	08350	08340
1-1/2 in. x 1-1/2 in.	08318	08362	08319	-	-	08322	08320
2 in. x 2 in.	08324	08407	08325	-	-	08328	08326

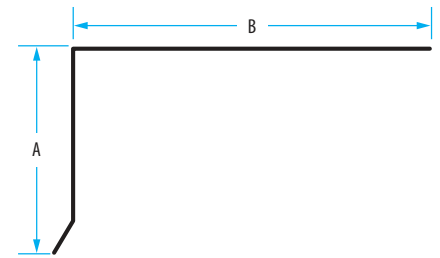
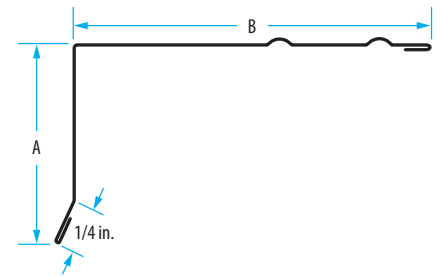

Style "G" Drip Edge Applied to the eave and rake to direct water away from the structure.
10 ft. lengths · Pack Quantity: 25

Size: A x B	Part #
2-1/2 in. x 1-1/2 in. - 28 Gauge Galvanized Steel - Unhemmed	91012
2-1/2 in. x 1-1/2 in. - 26 Gauge Galvanized Steel - Unhemmed	01884
2 in. x 4 in. - ST Gauge Galvanized Steel - Unhemmed	01886

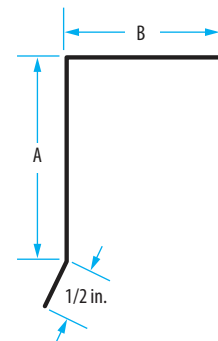

Style "D" Eave Drip Extended support for shingles at edge of the roof. Applied to the eave and rake to direct water away from the structure.
10 ft. lengths · Pack Quantity: 25

Style "D" Galvanized Eave Drip TYPE "L" (4 in. Girth · 1 in. Face)

Size: A x B	HT Gauge	ST Gauge
2-3/8 in. x 1 in. + 1/8 in. hem	01841	01840
2-3/8 in. x 1 in. + 1/8 in. hem - Almond	-	08363
2-3/8 in. x 1 in. + 1/8 in. hem - Black	-	08364
2-3/8 in. x 1 in. + 1/8 in. hem - Brown	-	08365
2-3/8 in. x 1 in. + 1/8 in. hem - Tan	-	08369B
2-3/8 in. x 1 in. + 1/8 in. hem - White	-	08370
2-3/8 in. x 1 in. + 1/8 in. hem - Weathered Wood	-	08369

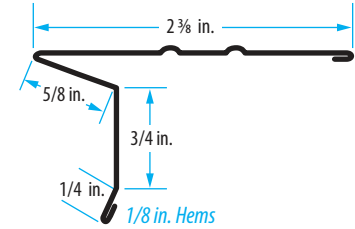

Style "D" Aluminum TYPE "L" (4 in. Girth · 1 in. Face)

2-3/8 in. x 1 in. + 1/8 in. hem. - ST Gauge Aluminum - Brown	02462
--	-------

Style "D" Galvanized Eave Drip TYPE "L" (4-1/2 in. Girth · 1-1/2 in. Face)

Size: A x B	ST Gauge
2 in. x 1-1/2 in. - Mill Finish	03981
2 in. x 1-1/2 in. - Almond	03974
2 in. x 1-1/2 in. - Black	03977
2 in. x 1-1/2 in. - Brown	03976
2 in. x 1-1/2 in. - Chesser Gray	03979
2 in. x 1-1/2 in. - Tan	03978
2 in. x 1-1/2 in. - White	03975
2 in. x 1-1/2 in. - Weathered Wood	03962

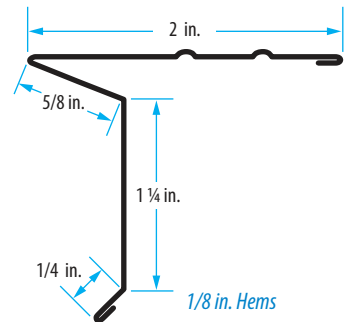

Style "D" Embossed Eave Drip TYPE "L" (4-1/2 in. Girth · 1-1/2 in. Face)

Size: A x B	ST Gauge
2 in. x 1-1/2 in. - Almond	07229
2 in. x 1-1/2 in. - Black	07230
2 in. x 1-1/2 in. - Brown	07232
2 in. x 1-1/2 in. - Tan	51277
2 in. x 1-1/2 in. - White	07231
2 in. x 1-1/2 in. - Weathered Wood	07228

Style "D" Aluminum TYPE "L" (4-1/2 in. Girth · 1-1/2 in. Face)

2 in. x 1-1/2 in. - ST Gauge Aluminum - White	90048
2 in. x 1-1/2 in. - ST Gauge Aluminum - Weathered Wood	90044



Trims and Flashings

Style "D" Galvanized Eave Drip TYPE "L" (1-3/4 in. Face) 10 ft. lengths · Pack Quantity: 25

Size: A x B	HT Gauge	ST Gauge	28 Gauge
3-7/16 in. x 1-3/4 in. - Mill Finish	11354	11356	-
3-7/16 in. x 1-3/4 in. - Almond	-	07267	-
3-7/16 in. x 1-3/4 in. - Black	-	-	512158
3-7/16 in. x 1-3/4 in. - Brown	-	11240	079138
3-7/16 in. x 1-3/4 in. - White	-	11448	079128
3-7/16 in. x 1-3/4 in. - Weathered Wood	-	01923	079148

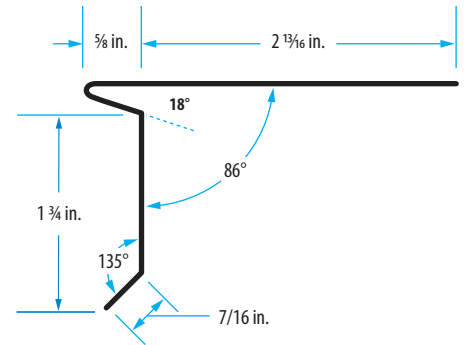

Style "D" Aluminum TYPE "L" (4-1/2 in. Girth · 1-1/2 in. Face)

3-7/16 in. x 1-3/4 in. - White	11402
--------------------------------	-------

Gutter Apron 135° inside angle to accommodate steeper roof pitch. 10 ft. lengths · Standard Gauge Galvanized Steel · Pack Quantity: 25

Size: A x B	ST Gauge
2 in. x 3 in. - Mill Finish	02069
2 in. x 3 in. - White	08399
2 in. x 3 in. - Weathered Wood	08383

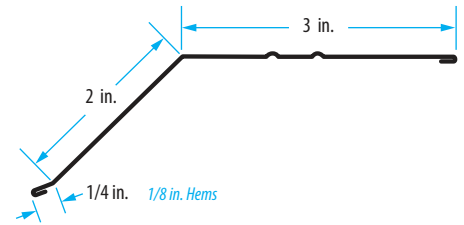

Gravel Guard A raised stop at the roof edge to prevent loss of ballast on flat or very low slope roofs. 10 ft. lengths · Standard Gauge Galvanized Steel · Pack Quantity: 25

Size: A x B	ST Gauge
2 in. x 2-1/2 in. - Mill Finish	01860
2 in. x 3-1/2 in. - Mill Finish	01862

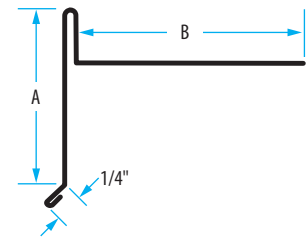

Modified Roof Edge A raised stop at the roof edge to prevent loss of ballast on flat or low slope roofs. 10 ft. lengths · Galvanized Steel · Pack Quantity: 25

Size: A x B	ST Gauge	28 Gauge
2-1/4 in. x 3-3/4 in. - Mill Finish	01880	-
3 in. x 4 in. - Mill Finish	01927	02006
3-1/4 in. x 4-1/4 in. - Mill Finish	01911	-
4 in. x 4 in. - Mill Finish	02475	-

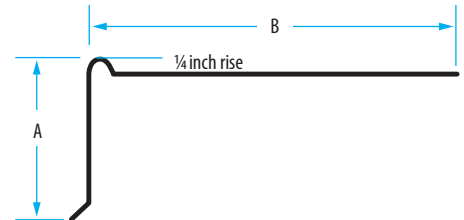



Roll Flashing

Galvanized Steel Roll Flashing

Galvanized 10 Foot Rolls

Width	Econo	QTY.
6 in.	17472	200
10 in.	17404	150
12 in.	01591	100
14 in.	17420	100
20 in.	17439	100

Galvanized 25 Foot Rolls

Width	Econo	QTY.
10 in.	17406	75
12 in.	17415	75
14 in.	17422	75
16 in.	01621	50
20 in.	17441	50
24 in.	01627	50

Galvanized 50 Foot Rolls

Width	Econo	Standard	QTY.
10 in.	17403	-	75
12 in.	17412	01644	75
14 in.	17419	-	75
16 in.	01704	17423	50
18 in.	01706	-	50
20 in.	17438	17435	25
24 in.	17446	17442	25
30 in.	-	-	25
36 in.	-	17458	25

26 Gauge Galvanized

Size	Weathered Wood	QTY.
24 in. x 25 ft.	07630	25

Painted Galvanized - ST Gauge

Size	Brown/W'Wood	QTY.
10 in. x 25 ft.	07632	75
10 in. x 50 ft.	10345-1	75
18 in. x 50 ft.	01441	50
20 in. x 50 ft.	01723	25



Aluminum Roll Flashing

Aluminum 10 Foot Rolls

Width	Econo Gauge	Pack
6 in.	01641	25
10 in.	17275	25
14 in.	17306	25
20 in.	17339	25

Aluminum 25 Foot Rolls

Width	Econo Gauge	Pack
6 in.	RV625A	25

Aluminum 50 Foot Rolls

Width	Econo Gauge	Pack
10 in.	17208	25
12 in.	17290	25
14 in.	17210	25
20 in.	17212	25



Painted Aluminum 10 Foot Rolls

Width	ST Gauge	Pack
10 in. - White/Brown	17191	25





Trims and Flashings

Step Flashing Separate pieces of Step Flashing are installed as each course of shingles are applied. This step application allows for all fasteners to be concealed.

Step Flashing Shingles - Galvanized

Description	Part #	Pack
4 in. x 4 in. x 8 in. HT Gauge (Boxed)	12020	100
4 in. x 6 in. x 14 in. ST Gauge	01784	50
5 in. x 5 in. x 7 in. ST Gauge	11992	100
6 in. x 6 in. x 10 in. ST Gauge	01779	50



Flat Flashing Shingles - Galvanized

Description	Part #	Pack
5 in. x 7 in. ST Gauge (Boxed)	90000	100
5 in. x 7 in. ST Gauge (Banded)	01757	100
7 in. x 8 in. ST Gauge	01762	100
8 in. x 8 in. ST Gauge (Banded)	01764	100

Flat Flashing Shingles - Painted Galvanized

Description	Part #	Pack
6 in. x 8 in. ST Gauge - Black	10436-1	100
6 in. x 8 in. ST Gauge - Weatherd Wood	10405-1	100
8 in. x 8 in. ST Gauge - Almond/Black	08377	100
8 in. x 8 in. ST Gauge - Brown/Weathered Wood	08372	100
8 in. x 14 in. ST Gauge - Brown/Weathered Wood	08380	50
9 in. x 12 in. ST Gauge - Brown/Weathered Wood	01040	50

Formed V-Valley Protects roof valleys from water infiltration. 10 ft. Lengths · Pack: 10 pieces

Description	Part #
15 in. - Open Hem - 26 Gauge	12032

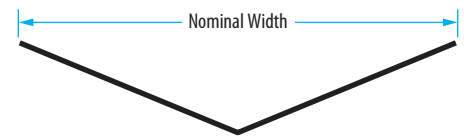

Formed W-Valley Protects roof valleys from water infiltration. 10 ft. Lengths · Pack: 10 pieces

Description	Galvanized	Black	Brown	W'd Wood
18 in. - ST Gauge	05142	-	-	-
20 in. - ST Gauge	01547	10464-1	01565	01566
24 in. - ST Gauge	01551	05180	01567	01552
20 in. - 28 Gauge	-	-	01397	01396
18 in. - 26 Gauge	01550	-	-	-
18 in. - Open Hem - 26 Gauge	14868	-	-	-
20 in. - 26 Gauge	01555	-	-	-
24 in. - 26 Gauge	01559	-	-	01755

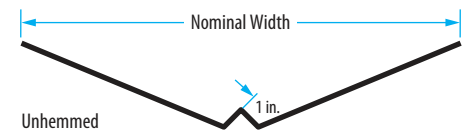

Unhemmed

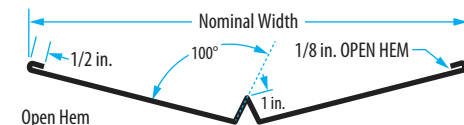

Open Hem



Trims and Flashings

Water Diverter Directs rain water run-off away from entrances. 10 ft. Lengths · Pack: 20 pieces

Description	Part #
1-1/2 in. x 4 in. - Standard Gauge Galvanized Steel	02067

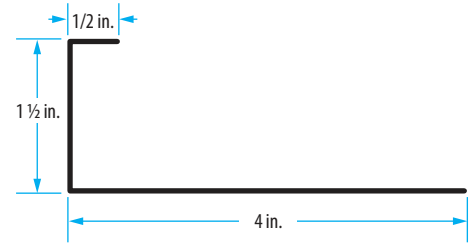

Z-Flashing Protects top edge of siding sheets from water infiltration. 10 ft. Lengths

Size: A x B x C	Description	Part #	Pack
5/8 in. x 3/8 in. x 2 in.	Econo Gauge Galvanized Steel	17837	50
3/8 in. x 3/4 in. x 1-7/8 in.	Econo Gauge Galvanized Steel	17833	50
1/2 in. x 1/2 in. x 1 in.	Standard Gauge Galvanized Steel	02105	25
1/2 in. x 3/8 in. x 1-1/8 in.	Standard Gauge Galvanized Steel	02103	25
1/2 in. x 3/8 in. x 2-1/8 in.	Standard Gauge Galvanized Steel	02113	25
1/2 in. x 5/8 in. x 7/8 in.	Standard Gauge Galvanized Steel	17845	50
1/2 in. x 5/8 in. x 1-7/8 in.	Standard Gauge Galvanized Steel	02117	25
1/2 in. x 7/16 in. x 1-1/16 in.	Standard Gauge Galvanized Steel	02109	50
1/2 in. x 3/4 in. x 1-3/4 in.	Standard Gauge Galvanized Steel	02121	50
1/2 in. x 3/4 in. x 3/4 in.	Standard Gauge Galvanized Steel	02111	25
1/2 in. x 1-1/4 in. x 1-1/4 in.	Standard Gauge Galvanized Steel	02116	25
1/2 in. x 1-1/4 in. x 2-1/4 in.	Standard Gauge Galvanized Steel	05083	25
1/2 in. x 1-1/2 in. x 2 in.	Standard Gauge Galvanized Steel	02125	25

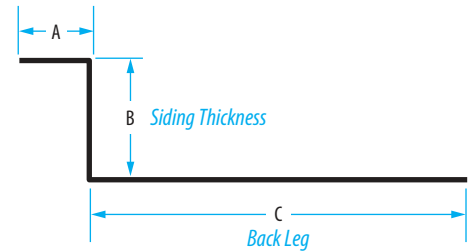



Pipe Flashing

Bullet Boot is a one piece flexible rubber flashing that installs directly over standard PVC vent pipes.
20 Boots per Bundle

Size	Black	Brown	Weathered Wood
1 1/2 in.	23221	23220	23236
2 in.	23225	23224	23237
3 in.	23229	23228	23238
4 in.	23233	23232	23239



Black



Brown



Weathered Wood



Adjustable Pipe Boots Mount directly over exposed vent pipes.

Aluminum Base

Description	Part #	QTY
1 in. - 3 in. Adjustable Rubber · Aluminum Base	23190	20
3 in. - 4 in. Adjustable Rubber · Aluminum Base	23191	20

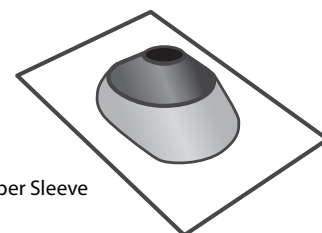

Rubber Sleeve

Galvanized Base

Description	Part #	QTY
1-1/2 in. - 3 in. Adjustable Rubber · Galvanized Base	23186	20
3 in. - 4 in. Adjustable Rubber · Galvanized Base	23187	20

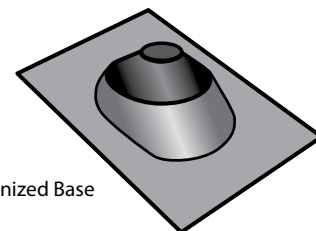

3' n' 1 Galvanized Base

Plastic Base

Description	Part #	QTY
1 in. - 3 in. Adjustable Rubber · Plastic Base	23188	20
3 in. - 4 in. Adjustable Rubber · Plastic Base	23189	20

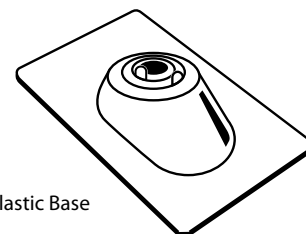

Hard Plastic Base

FHA Pipe Flashing Mount directly over exposed vent pipes. 26 Gauge Galvanized Steel.

Description	Part #	QTY
1-1/2 inch - FHA Base	RJ15FHA-SP	25
2 in. - FHA Base	RJ2FHA-SP	25
3 in. - FHA Base	RJ3FHA-SL	10
4 in. - FHA Base	RJ4FHA-SL	10

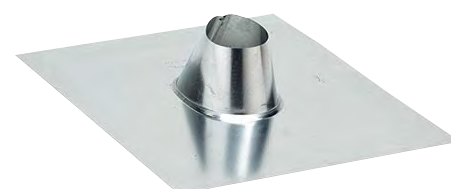

Rectangular Gable Louvers Screened louvers produced in Front Flange and Plaster ground mounts.
28 Gauge Galvanized Steel · 1/8 inch mesh

Description: A x B	N.F.V.	Part #	QTY
12 in. x 12 in. - Flange Front	63 sq. in.	GLFF1212G-1/8	10
12 in. x 18 in. - Flange Front	93 sq. in.	GLFF1218G-1/8	10
14 in. x 18 in. - Flange Front	110 sq. in.	GLFF1418G-1/8	10
14 in. x 24 in. - Flange Front	147 sq. in.	GLFF1424G-1/8	10
18 in. x 24 in. - Flange Front	190 sq. in.	GLFF1824G-1/8	5
24 in. x 30 in. - Flange Front	317 sq. in.	GLFF 2430G-1/8	5
12 in. x 12 in. - Plaster Ground	63 sq. in.	GLPG1212G-1/8	10
14 in. x 12 in. - Plaster Ground	65 sq. in.	GLPG1412G-1/8	10
14 in. x 18 in. - Plaster Ground	110 sq. in.	GLPG1418G-1/8	10
18 in. x 24 in. - Plaster Ground	190 sq. in.	GLPG1824G-1/8	5

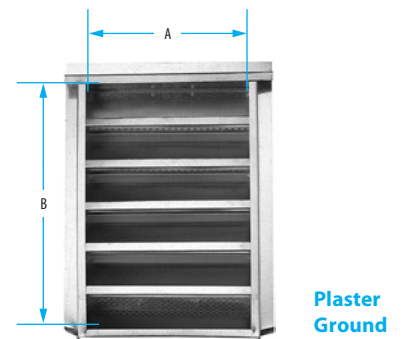
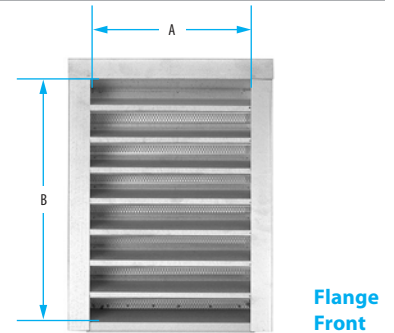

Total JACK™ The only roof jack with an adjustable stack and base. Adjusts to fit most roof pitches.
US Patents #8,534,013 B3 and #8,615,943 B2.

Size	Mill	Black	Brown	Weath. Wood	QTY
6 inch	JACK6GZ	JACK6BLK	JACK6BRN	JACK6WWD	7
8 inch	JACK8GZ	JACK8BLK	JACK8BRN	JACK8WWD	8

Galvanized steel in accordance to ASTM A924/A653
Base Thickness: Galvanized 0.016 in. / Painted 0.019 in.
Stack Thickness: Galvanized 0.012 in. / Painted .013 in.
Cap Thickness: Galvanized 0.012 in. / Painted 0.013 in.





Gutter Protection

Clean Mesh® Advanced gutter protection system. Stainless steel micro mesh is effective against small debris, including pine needles, seed pods and shingle grit. Fascia mount for 5 in. or 6 in. K-Style gutters. Available in 3 and 4 ft. lengths. Patent: 8,474,192



Screen Mesh® Advanced gutter protection system. Durable aluminum construction with stainless steel micro mesh Under shingle mount for 5 in. or 6 in. Super Gutters, Box Gutters and K-Style gutters. Available in 4 and 5 ft. lengths. Patent: 8,474,192

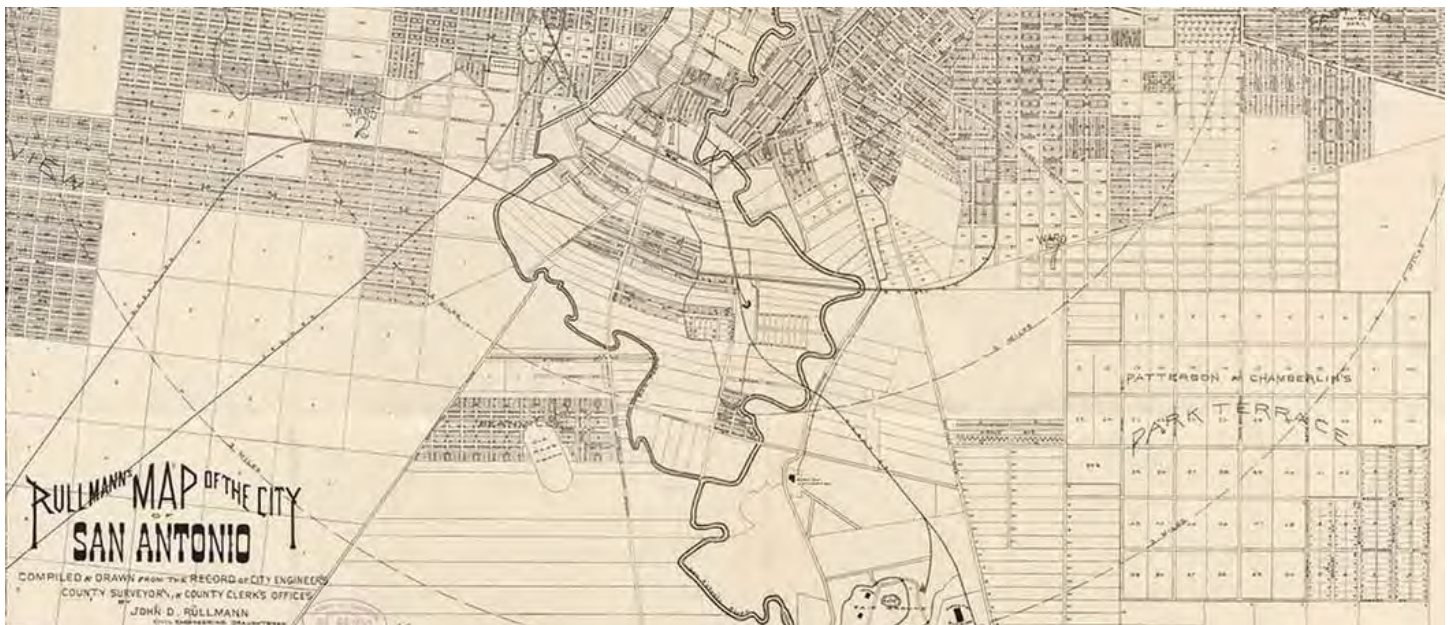



Drywall Corner Bead

Galvanized Drywall Corner Bead Extra wide knurled flanges provide excellent joint compound, paint & texture plaster bond adhesion. Can be fastened to drywall corners with nails, screws, or clinching tools. Unlike paper tape, steel nose beads are the most problem free from scuffing and fuzing.

Bare Metal Corner Bead

Description	Part #	QTY
1-1/4 in. x 1-1/4 in. x 8 ft. Galvanized Corner Bead	10530	63
1-1/4 in. x 1-1/4 in. x 9 ft. Galvanized Corner Bead	10532	56
1-1/4 in. x 1-1/4 in. x 10 ft. Galvanized Corner Bead	10524	50

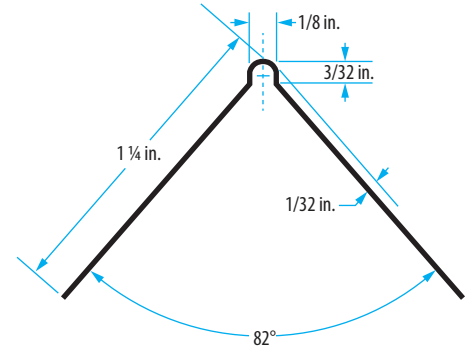

Vinyl Corner Bead

Description	Part #	QTY
3/4 in. Radius x 10 ft. Vinyl Bullnose Corner Bead	10514	35

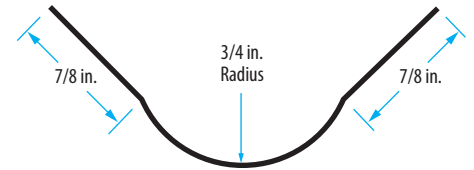

Insulation Support Wire A quick and economical way to hold insulation in place between studs and joist. 13 Gauge Galvanized Steel.

Description	Part #	QTY.
16 in. Insulation Support Wire	34015	500
24 in. Insulation Support Wire	34016	500

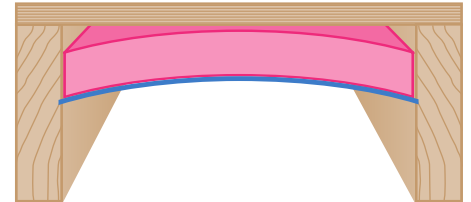

H-Moulding Used to splice butt joints of plywood soffit systems. Aluminum Extrusion

Description	Part #	QTY.
3/8 in. x 12 ft. Aluminum H-Moulding	12754	50

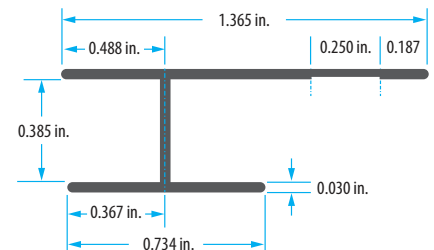

Mobile Home Skirting Embossed galvanized steel panels in a convenient size. The panels can be attached to a simple frame for mobile home skirting or utilized as a decorative wall covering.

Description	Part #	Bundle	Pallet
26 Gauge Galvanized Steel - 28 in. x 60 in.	13174	10	500





Stucco and Plaster Products

Casing Bead Creates a flush stucco stop for framed doors, windows, and other openings. A ridge of nail holes provides for easy installation.

Description	Part#	Carton	Pallet
1/2 in. x 10 ft. Galvanized Steel Casing Bead	10521	30	600

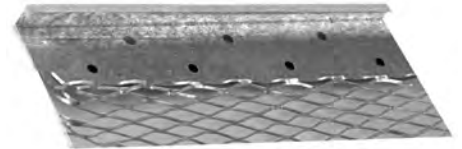

Expanded Outside Corner Bead Expanded diamond mesh wings allow for keying the plaster right up to the nose of the bead. Provides plumb reinforcement at corners.

Description	Part#	Carton	Pallet
10 ft. Galvanized Steel Outside Corner Bead	10507	30	630



Expanded Inside Corner Bead Finished edge corner lath provide reinforcement for plastered inner corners. Preshaped to 105° for a snug fit in 90° corners with wings tight against the plaster base.

Description	Part#	Carton	Pallet
3 in. x 3 in. x 10 ft. Galvanized Steel Inside Corner Bead	10521	75	1125

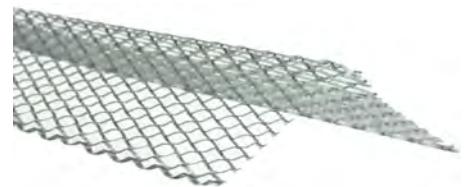

Galvanized Metal Lath A multi-purpose utility lath base for use with either steel or wood framing.

Description	Part#	Carton	Pallet
27 in. x 96 in. Galvanized Steel 2.5 Diamond Mesh	13189	--	---

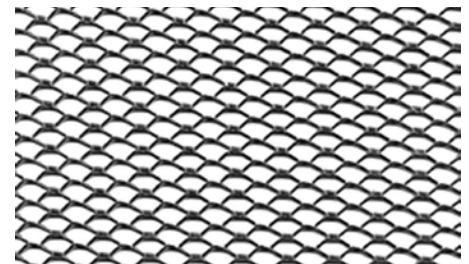

Rooftop Safety Kit Provides the basic safety tools for OSHA Compliance.

- Universal full body harness
- No tangle vertical lifeline assembly with a swivel snap hook, and integrated shock absorber
- Permanent positioning device with an 18 inch lanyard extension to help keep the device within reach
- 1 Heavy Duty tempered reusable anchor.
- 3-1/2 gallon bucket

Description	Part#	QTY
Rooftop Fall Protection Kit	HD-00815-QC	1



10 in. Adjustable Roof Bracket
10 per carton



HD-2500

10 in. 45° Roof Bracket
10 per carton



HD-2501

6 in. 90° Roof Bracket
10 per carton



HD-2502

Roof Anchors

Reusable Temper Roof Anchor

HD-004455
QTY: 10

Fasteners included



Permanent Double D Roof Anchor

For permanent use on wood roofs

HD-00510-QC
QTY: 10



Description	Part#	QTY
Reusable Roof Anchors - Fasteners included	HD-00455	10
Permanent Roof Anchors	HD-00510	10

Fall Protection Harness Seraph

11160-QC
QTY: 5



Description	Part#	QTY
Cyclone HUV (Med.-Large)	HD-11160	5

Lanyard

6 ft. Shock Absorbing Lanyard



Description	Part#	QTY
6 ft. Shock Absorbing Lanyard	HD-01220	1

50 ft. Lifeline

Heavy duty poly rope resists cuts, abrasions and water absorption. Attached self locking carabineer



Description	Part#	QTY
50 ft. Lifeline	HD-01320	4

5V Crimp Panels	3	Lanyard	19
50 ft. Lifeline	19	Mobile Home Skirting	17
Adjustable Pipe Boots	14	Modified Roof Edge	10
Angle Flashing	6	Pipe Flashing	14
Apron Flashing	6	Ridge Roll Flashing	5
Bullet Boot	14	Roll Flashing	11
Butyl Tape	5	Roof Anchors	19
Casing Bead, Stucco	18	Roof Brackets	19
Clean Mesh®	16	Rooftop Safety Kit	19
Closure Strips	5	Screen Mesh®	16
Corrugated Panels	4	Shock Absorbing Lanyard	19
Counter Flashing	7	SM-Rib Panels	4
Drip Cap	7	Step Flashing	12
Drywall Corner Bead	17	Style "A" Drip Edge	8
Expanded Inside Corner Bead	18	Style "D" Eave Drip	9
Expanded Outside Corner Bead	18	Style "G" Drip Edge	8
Fall Protection Harness	19	Total JACK™	15
FHA Pipe Flashing	14	Turnback Flashing	6
Flat Flashing Shingles	12	Vinyl Corner Bead	17
Formed Valley	12	V-Valley	12
Gable Louvers	15	Water Diverter	13
Galvanized Metal Lath	18	Woodfast Screws	5
Gravel Guard	10	W-Valley	12
Gutter Apron	10	Z-Flashing	13
Gutter Protection	16		
Head Flashing	7		
H-Moulding	17		
Insulation Support Wire	17		





APPLETON SUPPLY CO., INC.

A GIBRALTAR INDUSTRIES COMPANY 

PRODUCT CATALOG

**Soffit & Fascia
Flashing
Trims & Edging
Siding & Accessories
Trim Coil & Roll Valley
Gutter Protection
Safety Products**

GIBRALTAR
INDUSTRIES

www.gibraltarbuildingproducts.com



at APPLETON SUPPLY COMPANY
Teamwork is our
ULTIMATE
Competitive Advantage

Welcome! If you're looking for the first choice in metal products and roofing accessories, you've come to the right place.

Since 1918, building professionals and distributors have relied on Appleton Supply for metal building products that stand the test of time – like our industry respected Appleton Building Products™ and Sell-Even® brand aluminum soffit systems.

The fact is, customers consistently give Appleton Supply superior rating for quality, availability and service. We deliver quality products our customers can count on, when they need them, at a fair price – benchmarks we value in our reputation.

Appleton Supply is a Gibraltar Industries Company. Gibraltar is a leading manufacturer and distributor of products for residential, commercial and industrial construction. Gibraltar serves a large number of customers in a variety of industries in all 50 states and throughout the world from facilities in the United, States, Canada, and Europe. Gibraltar's common stock is a component of the S&P Small Cap 600 and the Russell 2000® Index.

ENVIRONMENTAL RESPONSIBILITY

Appleton Supply Company is dedicated to reducing waste in addition to improving our business processes to be more environmentally friendly. We have collaborated with both our vendors and customers to help reduce our impact on the environment. The importance of environmental responsibility is promoted to all of our employees while on the job and in day to day life. Materials used in our manufacturing and other business processes are recycled and can be recycled continuously for years to come.

CUSTOMER FOCUSED - DELIVERED WHEN AND WHERE YOU NEED THEM

Through its wholesale and retail distribution, Appleton Supply Company supplies quality building products to homeowners, builders, contractors and architects with a quality product, guaranteed! Appleton Supply works with a dedicated fleet of trucks to deliver your order on time, every time!

CUSTOMER SERVICE: 1-800-558-3414 • FAX: 920-738-4249 • DELIVERIES: 7 TO 10 BUSINESS DAYS

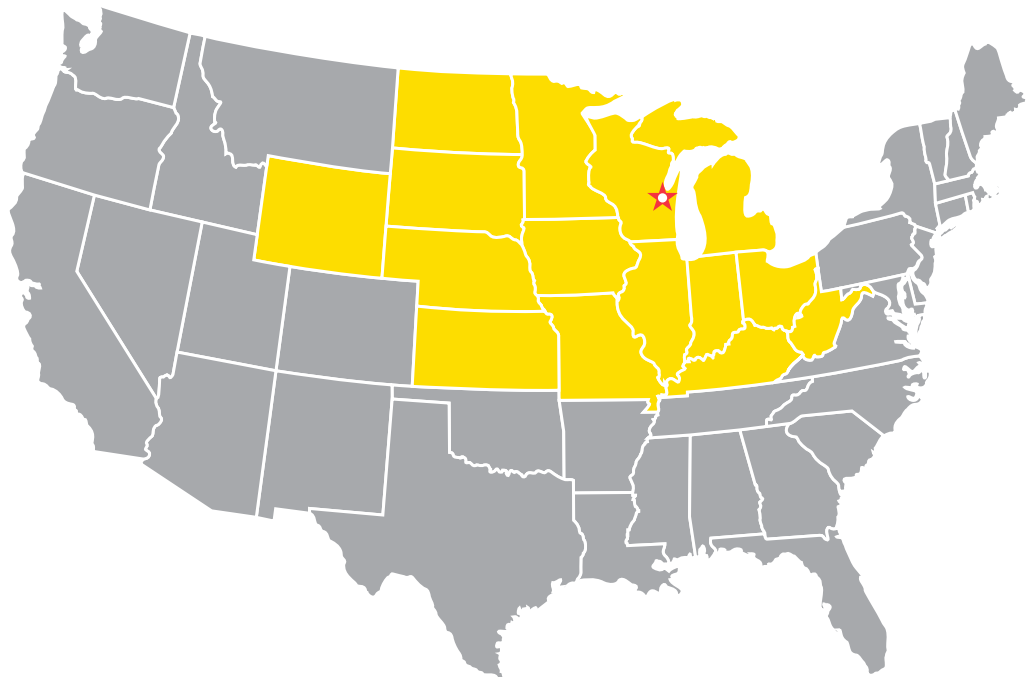

Note: All dimensions in this catalog are to be considered nominal.



SOFFIT & FASCIA

2-Panel Aluminum Soffit Panels	3
Liberator Bathroom Fan Soffit Termination.....	3
3-Panel Aluminum Soffit Panels	4
4-Panel Aluminum Soffit Panels	5
Fascia - Aluminum & Steel	6
Double Channel	7
J Channel	7
Frieze Runner	7

FLASHINGS

Angle Flashing	8
Chimney Flashing Kit	8
Chimney Flashing Reglet	8
Deck Flashing	8
Drip Cap	9
Dormer Flashing.....	9
Roof Starter.....	9
Flashing Shingles - Flat	0
Flashing Shingles - Formed	10
SplashShield™	10
Kick-Out Flashing.....	10
Kwik Plug™	11
Rain Diverter	11
W Valley	11
Z-Flashing	11

TRIMS AND EDGINGS

A Edging	12
D Edging	12
Gutter Apron	13
Brick Moulding	13

ALUMINUM SIDING AND ACCESSORIES

Siding	14
Siding J-Channel	14
Undersill Trim	14
Corner Post - Outside	14
Corner Post - Inside	14
Siding Starter Strip	15
Foam Backer	15
Siding Corners - Hardboard Siding.....	15
Backflash	15
H-Moulding	16

RIM COIL AND ROLL FLASHING

Painted Trim Coil	17
PVC Trim Coil	17
Roll Flashing – Aluminum	18
Roll Flashing – SGalvanized teal	18
Roll Flashing – Copper	18

WALL BRACE, SAFETY AND CLEANMESH

Wall Bracing	19
Roof Brackets	19
Rooftop Safety Equipment.....	19
Cleanmesh™	20
Kwikmesh™ - Galvanized 1/8 mesh Roll.....	20

COLOR GUIDES

Soffit, Fascia, Ventilation, Flashings, Trim & Edgings.....	21
Trim Coil Colors	22

Index	23
--------------------	----





2-Panel Aluminum Soffit

Soffit Panels are precision formed to interlock for a professional finish for eave and overhang areas
12 ft. Lengths · 0.019 Aluminum · Durable baked-on polyester finish

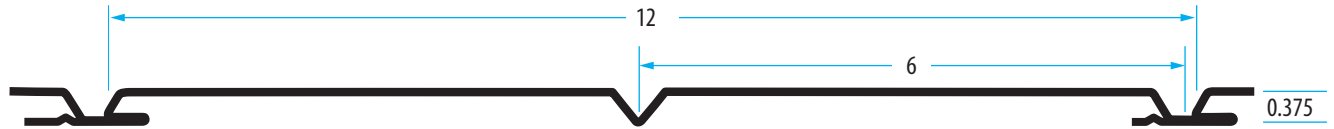

2-Panel Soffit - 12 in. width - 17 pieces per carton - 34 cartons per pallet

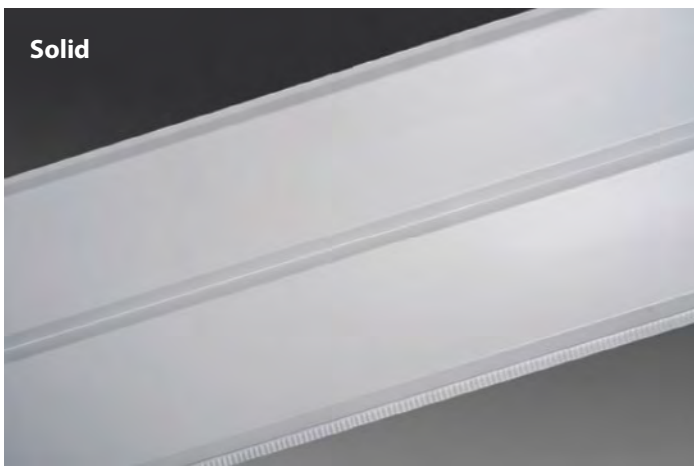

Solid



Vented

13.96 sq. in.
N.F.A.

SOLID

Color	Part#
Birch White	2SS12-WH
Royal Brown	2SS12-RBR
Terra Bronze	2SS12-TB

VENTED

Color	Part#
Birch White	2FVS12-WH
Royal Brown	2FVS12-RBR
Terra Bronze	2FVS12-TB

Liberator Bathroom Fan Soffit Termination System - Part# LIBERATOR

The Liberator soffit termination system streamlines installation and helps optimize airflow by allowing complete ducting before soffit panel installation. This high performance soffit vent improves overall fan performance. The Liberator soffit termination system is ideal for new residential construction. The patent pending design eliminates water intrusion costs associated with roof and/or wall terminations

- Designed for ventilation fans up to 110 CFM using 4 inch ductwork
- High performance soffit vent improves overall fan performance
- Easy installation results in a professional appearance
- Unique design eliminates water intrusion commonly associated with roof and/or wall terminations
- Low resistance backdraft damper eliminates cold drafts and improves blower door test results
- Mounting bracket can be located anywhere with a vertical surface within the overhang
- Overall height is less than 6 in. and fits in most 4/12 pitch roof overhangs
- Flush mounted termination grill mounts with a single fastener (included)
- 1 per carton



LIBERATOR



3-Panel Aluminum Soffit

Soffit Panels are precision formed to interlock for a professional finish for eave and overhang areas
12 ft. Lengths · 0.019 Aluminum · Durable baked-on polyester finish

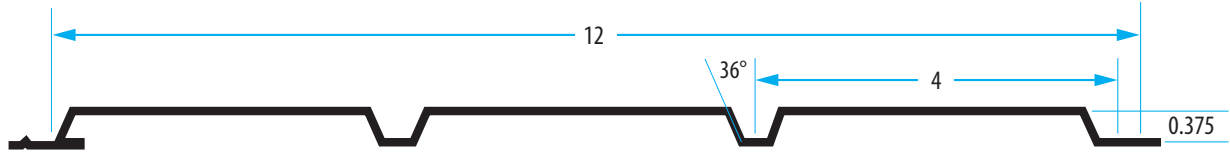

3-Panel Soffit - 12 in. width - 17 pieces per carton - 34 cartons per pallet

Solid



SOLID

Color	Part#
Almond	3PSS12-AL
Birch White	A3SS12-WH
Coffee	3PSS12-CF
Copper Penny	3PSS12-CP
Heritage Gray	3PSS12-HGRY
Hickory	3PSS12-HKY
Hunter Green	3PSS12-HG
Khaki	3PSS12-MKHAKI
Royal Brown	A3SS12-RBR
Sandstone	3PSS12-STONE
Terra Bronze	3PSS12-TB

Vented

N.F.A. 3.24 sq. in. /ft.



VENTED

Color	Part#
Almond	3PVS12-AL
Birch White	A3VS12-WH
Coffee	3PVS12-CF
Copper Penny	3PVS12-CP
Heritage Gray	3PVS12-HGRAY
Hickory	3PVS12-HKY
Hunter Green	3PVS12-HG
Khaki	3PVS12-MKHAKI
Royal Brown	A3VS12-RBR
Sandstone	3PVS12-STONE
Terra Bronze	3PVS12-TB

Fully Vented

N.F.A. 9.72 sq. in. /ft.



FULLY VENTED

Color	Part#
Birch White	3PFVS12-WH
Royal Brown	3PFVS12-RBR

PVC COATED VENTED

N.F.A. 3.24 sq. in. /ft.

Color	Part#
Birch White	PVC3VS12-WH

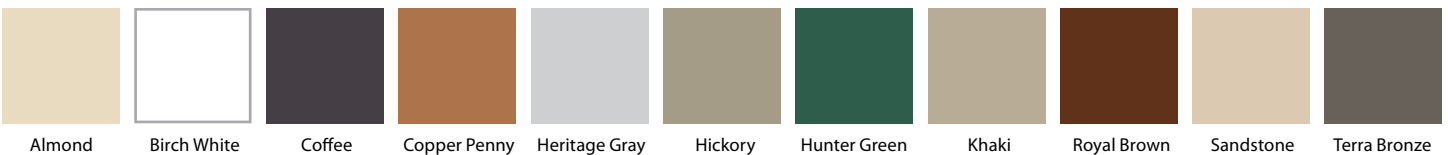



4-Panel Aluminum Soffit

Soffit Panels are precision formed to interlock for a professional finish for eave and overhang areas
12 ft. Lengths · 0.019 Aluminum · Durable baked-on polyester finish

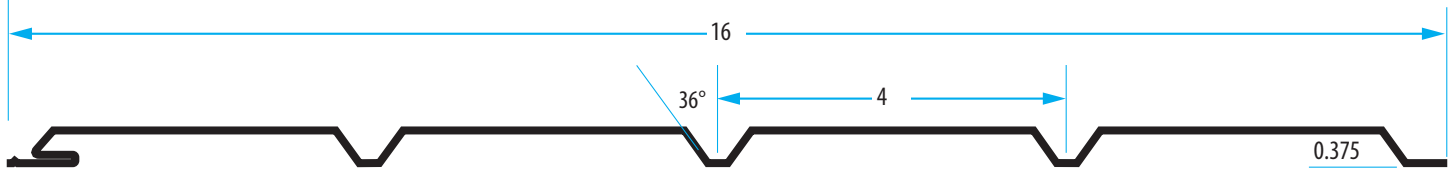

4-Panel Soffit - 16 in. width - 12 pieces per carton - 34 cartons per pallet



Solid

SOLID

Color	Part#
Almond	4PSS16-AL
Birch White	A4SS16-WH
Black	4PSS16-BL
Coffee	4PSS16-CF
Copper Penny	4PSS16-CP
Desert Tan	4PSS16-DT
Driftwood	4PSS16-DW
Heritage Gray	4PSS16-HGRAY
Hickory	A4SS16-HKY
Hunter Green	4PSS16-HG
Khaki	4PSS16-MKHAKI
Royal Brown	A4SS16-RBR
Sandstone	4PSS16-STONE
Terra Bronze	4PSS16-TB

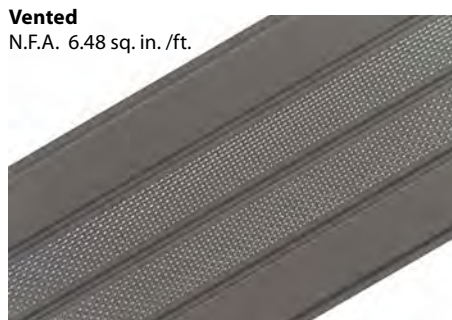

Vented
N.F.A. 6.48 sq. in. /ft.

VENTED

Color	Part#
Almond	4PVS16-AL
Birch White	A4VS16-WH
Black	4PVS16-BL
Coffee	4PVS16-CF
Copper Penny	4PVS16-CP
Desert Tan	4PVS16-DT
Driftwood	4PVS16-DW
Heritage Gray	4PVS12-HGRAY
Hickory	A4VS16-HKY
Hunter Green	A4VS16-HG
Khaki	4PVS16-MKHAKI
Royal Brown	A4VS16-RBR
Sandstone	4PVS16-STONE
Terra Bronze	4PVS16-TB

PVC COATED VENTED SOFFIT

N.F.A. 6.48 sq. in. /ft.

Color	Part#
Birch White	PVC4VS16-WH



Vented
N.F.A. 12.96 sq. in. /ft.

FULLY VENTED

Color	Part#
Birch White	4PFVS16-WH
Hickory	4PFVS16-HKY
Royal Brown	4PFVS16-RBR

Color Matched Aluminum Trim Nails - 1 lb.

Almond	TN-AL
Coffee	TN-CF
Copper Penny	TN-CP
Gray	TN-GY
Sandstone	TN-STONE
Antique Ivory	TNTC-AIVY
Cobalt	TNTC-CBT
Clay	TNTC-CLAY
Charcoal	TNTC-COAL
Cobblestone	TNTC-COB
Pecan	TNTC-PCN
Pine	TNTC-PINE
Slate	TNTC-SL
Sand	TNTC-SND
Tan	TNTC-TN





Aluminum Fascia Used to cover the wood trim between the roof and soffit. 12 ft. Lengths · 0.024 Aluminum · Durable baked-on polyester finish
25 pieces per carton · 50 Cartons per pallet

4 in. Aluminum Fascia - Smooth

Color	Part#
Almond	FH4-AL
Birch White	FH4-WH
Coffee	FH4-CF
Hickory	FH4-HKY
Hunter Green	FH4-HG
Royal Brown	FH4-RBR
Sandstone	FH4-STONE
Terra Bronze	FH4-TB

4 in. Aluminum Fascia - Cedar

Color	Part#
Birch White	FH4-CR-WH

Fascia Surface Textures

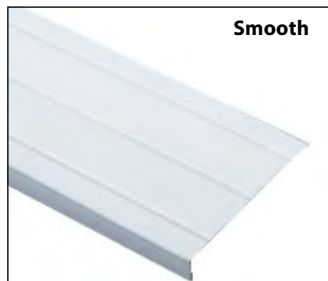

Smooth

Ribbed, Hemmed



Cedar

Light woodgrain pattern
No Ribbing, Hemmed

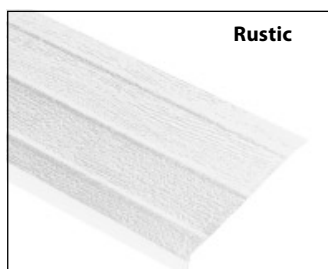

Rustic

Woodgrain pattern
Ribbed, Unhemmed

6 in. Aluminum Fascia - Smooth

Color	Part#
Almond	FH6-AL
Birch White	AFH6-WH
Black	FH6-BL
Coffee	FH6-CF
Copper Penny	FH6-CP
Desert Tan	FH6-DT
Driftwood	FH6-DW
Heritage Gray	FH6-HGRAY
Hickory	AFH6-HKY
Hunter Green	AFH6-HG
Khaki	FH6-MKHAKI
Royal Brown	AFH6-RBR
Sandstone	FH6-STONE
Sierra	FH6-SR
Terra Bronze	FH6-TB

6 in. Aluminum Fascia - No Ribs

Color	Part#
Birch White	FH6-NR-WH

6 in. Aluminum Fascia - Cedar

Color	Part#
Almond	FH6-CR-AL
Birch White	FH6-CR-WH
Coffee	FH6-CR-CF
Hickory	FH6-CR-HKY
Khaki	FH6-CR-MKHAKI
Royal Brown	FH6-CR-RBR
Sandstone	FH6-CR-STONE

6 in. Aluminum Fascia - Rustic

Color	Part#
Almond	F6-R-AL
Birch White	F6-R-WH
Coffee	F6-R-CF
Copper Penny	F6-R-CP
Heritage Gray	F6-R-HGRAY
Hickory	F6-R-HKY
Khaki	F6-R-MKHAKI
Royal Brown	F6-R-RBR
Sandstone	F6-R-STONE
Terra Bronze	F6-R-TB

8 in. Aluminum Fascia - Smooth

Color	Part#
Almond	FH8-AL
Birch White	AFH8-WH
Black	FH8-BL
Coffee	FH8-CF
Copper Penny	FH8-CP
Desert Tan	FH8-DT
Driftwood	FH8-DW
Heritage Gray	AFH8-HGRAY
Hickory	AFH8-HKY
Hunter Green	AFH8-HG
Khaki	FH8-MKHAKI
Royal Brown	AFH8-RBR
Sandstone	FH8-STONE
Terra Bronze	FH8-TB

8 in. Aluminum Fascia - Cedar

Color	Part#
Almond	FH8-CR-AL
Birch White	FH8-CR-WH
Royal Brown	FH8-CR-RBR
Terra Bronze	FH8-CR-TB



10 in. Aluminum Fascia - Smooth

Color	Part#
Almond	FH10-AL
Birch White	FH10-WH
Coffee	FH10-CF
Hickory	FH10-HKY
Hunter Green	FH10-HG
Royal Brown	FH10-RBR
Sandstone	FH10-STONE
Terra Bronze	FH10-TB

6 in. 0.015 Steel Fascia - Cedar

Color	Part#
Birch White	FH6-CRS-WH

6 in. 0.015 Steel Fascia - Rustic

Color	Part#
Birch White	FH6-RS-WH
Hickory	FH6-RS-HKY
Royal Brown	FH6-RS-RBR

12 ft. · 15 pcs per carton · 44 cartons per pallet

8 in. 0.015 Steel Fascia - Rustic

Color	Part#
Birch White	FH8-RS-WH

6 in. PVC Coated Fascia

Color	Part#
Birch White	PVCFH6-WH

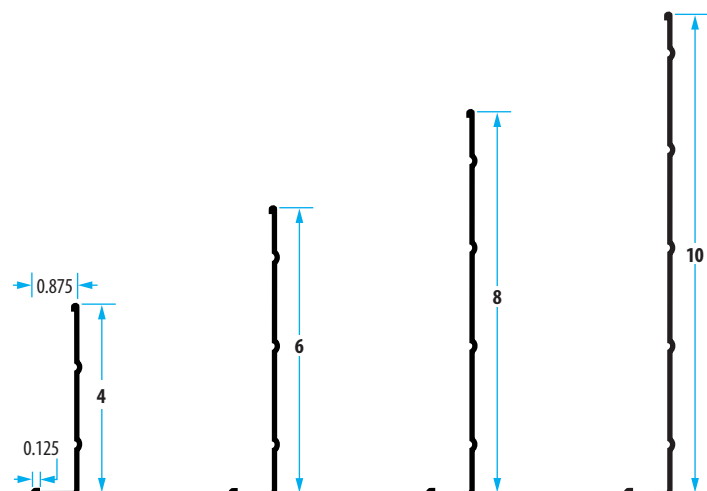



Double Channel Soffit support channel installed in corners where two soffit runs come together.
10 ft. lengths · 0.019 Aluminum · 5 pieces per carton · 50 cartons per pallet

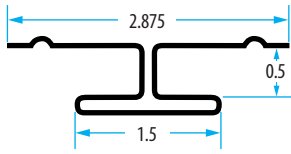

Color	Part#	Color	Part#
Almond	DC-AL	Hickory	ADC-HKY
Birch White	ADC-WH	Hunter Green	DC-HG
Coffee	DC-CF	Khaki	DC-MKHAKI
Copper Penny	DC-CP	Royal Brown	ADC-RBR
Driftwood	DC-DW	Sandstone	DC-STONE
Heritage Gray	ADC-HGRAY	Terra Bronze	DC-TB

J-Channel Soffit support channel installed at the wall or used to finish a run of siding
12 ft. lengths · 0.019 Aluminum · 25 pieces per carton · 50 cartons per pallet

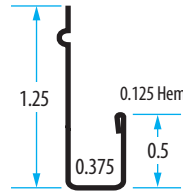

Color	Part#	Color	Part#
Almond	UT-AL	Heritage Gray	AUT-HGRAY
Birch White	AUT-WH	Hickory	AUT-HKY
Black	UT-BL	Hunter Green	AUT-HG
Coffee	UT-CF	Khaki	UT-MKHAKI
Copper Penny	UT-CP	Royal Brown	AUT-RBR
Desert Tan	UT-DT	Sandstone	UT-STONE
Driftwood	UT-DW	Terra Bronze	UT-TB

Frieze Runner (F-Channel) Soffit support channel installed at the wall. 12 ft. lengths · 0.019 Aluminum · 25 pieces per carton · 50 cartons per pallet

Frieze Runner

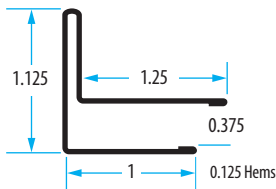

Color	Part#	Color	Part#
Almond	FRP-AL	Hickory	AFRP-HKY
Birch White	AFRP-WH	Hunter Green	FRP-HG
Black	FRP-BL	Khaki	AFRP-MKHAKI
Coffee	FRP-CF	Royal Brown	FRP-RBR
Copper Penny	FRP-CP	Sandstone	FRP-STONE
Heritage Gray	FRP-HGRAY	Terra Bronze	FRP-TB

Reversible Frieze Runner

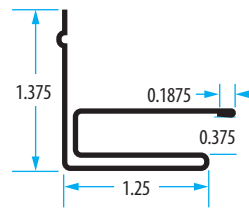

Color	Part#	Color	Part#
Almond	RFR-AL	Hickory	RFR-HKY
Birch White	RFR-WH	Hunter Green	ARFR-HG
Coffee	RFR-CF	Royal Brown	ARFR-RBR
Desert Tan	RFR-DT	Sandstone	ARFR-STONE
Driftwood	RFR-DW	Terra Bronze	ARFR-TB





Flashings

Angle Flashing Protection along dormers and rooflines. Installed under the course of shingles along the roof line. 10 ft. lengths.

1 in. x 3 in. - Inside Angle

0.016 Aluminum
50 pieces per carton · 45 Cartons per pallet

Color	Part #
Snow White	A1X3-SW

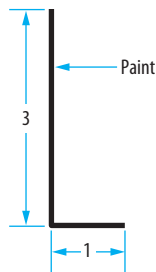

Chimney Flashing Kit contains precut flashing or a typical one-flue brick chimney up to 32 in. by 32 in.

Color	Part #	Carton	Pallet
Black	310122-BL	1	45
Mill	310122	1	45
Royal Brown	310122-RBR	1	45
Weathered Wood	310122-WW	1	45

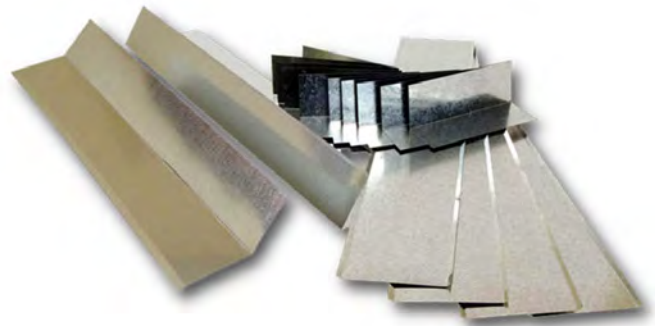

Four 32 in. Side Flashings, Twelve 6 in. x 8 in. Step Flashings
30 Gauge Galvanized Steel.

Chimney Flashing Reglet 30 Gauge Galvanized Steel. 10 ft. lengths.

Color	Part #	Carton	Pallet
Black	CFGBL	10	45
Mill	CFGM	10	45
Royal Brown	CFG BR	10	45
Weathered Wood	CFGWW	10	45

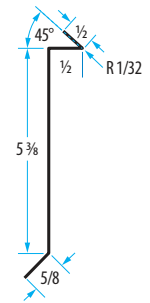

Deck Flashing

Prevents moisture from entering the house at your ledger board connection.
30 Gauge Galvanized Steel. 10 ft. lengths.

Color	Part #	Carton	Pallet
Royal Brown	4DECKBRG	25	45
Weathered Wood	4DECKWWG	25	45

Color	Part #	Carton	Pallet
Premium Deck Flashing Black	PDFLASH	10	-
Deck Flashing Weathered Wood	4DECKWW	25	-

STANDARD

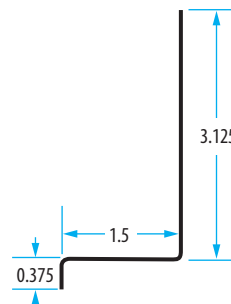

PREMIUM

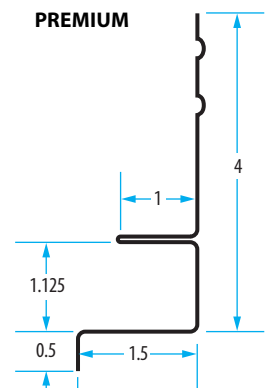

Note: Must have a protective barrier when installed with treated lumber



Aluminum Drip Cap 10 ft. lengths · 0.019 in. (nom.) · 50 pieces per carton · 45 Cartons per pallet

Size: A x B	White	Birch White	Polar White	Hickory	Brown	Mill
1 in. x 1-5/8 in.		-	1WH	-	-	-
1-1/8 in. x 1-5/8 in.		-	815WH	-	-	-
1-1/4 in. x 1-1/4 in.	ADC125-WH	-	-	ADC125-HKY	ADC125-RBR	-
1-1/4 in. x 1-1/2 in.		-	816WH	-	816BR	816
1-3/8 in. x 1-3/8 in.		-	817WH	-	817BR	-
1-1/2 in. x 1-1/8		ADC15-WH				
1-5/8 in. x 1-1/8 in.		-	818AWH	-	-	-
1-3/4 in. x 1 in.		-	827WH	-	827BR	-
2 in. x 1 in.		-	829AWH	-	829ARBR	-

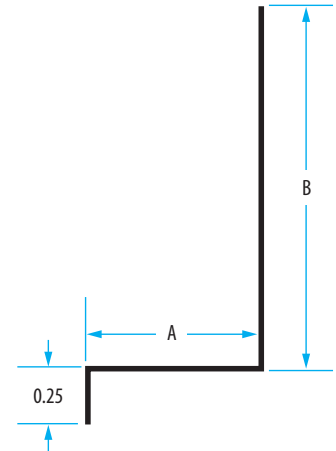

Steel Drip Cap 10 ft. lengths · 0.012 in. (nom.) · 50 pieces per carton · 45 Cartons per pallet

Size: A x B	White	Birch White	Polar White	Hickory	Brown	Mill
1-1/2 in. x 1-5/8 in.		-	825GWH	-	-	-

Dormer Flashing Diverts water away from the structure where the front of a dormer wall meets the roofline.

Wall Flash

0.019 in. Aluminum
25 pcs/ctn · 45 ctn/pal

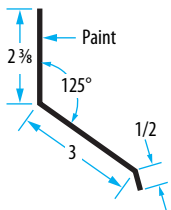

Color	Part #
Black	WALLFLASH-BL
W'Wood	WALLFLASH-WW

Roof Starter

0.012 in. Steel
25 pcs/ctn · 45 ctn/pal

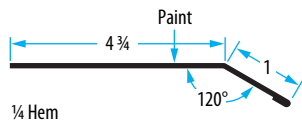

Color	Part #
Polar White	6GRSWH
Brown	6GRSBR

Dormer Flashing

0.012 in. Steel
10 pcs/ctn · 45 ctn/pal

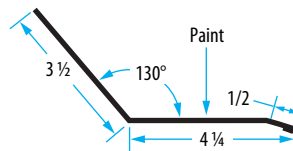

Color	Part #
Black	3X5GDF-BL
Mill	3X5GDF
Brown	3X5GDF-BR
W'Wood	3X5GDF-WW

Dormer Flashing - Heavy

0.015 in. Steel
10 pcs/ctn · 45 ctn/pal

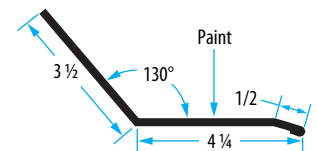

Color	Part #
Black	3X5GDFH-BL
Mill	3X5GDF-HEAVY
Royal Brown	3X5GDFH-BR
W'Wood	3X5GDFH-WW





Flashings

Aluminum Flat Shingles - 0.012 in.

100 pieces per bundle · 100 bundles per pallet

Description	Part #
5 in. x 7 in. - Mill Finish	963
8 in. x 8 in. - Mill Finish	8X8STD

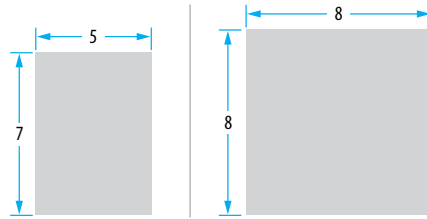

Steel Flat Shingles - 0.012 in.

100 pieces per bundle · 100 bundles per pallet

Description	Part #
5 in. x 7 in. - Mill Finish	964
8 in. x 8 in. - Mill Finish	8X8GALV

Aluminum Formed Shingles

100 pieces per bundle · 100 bundles per pallet

Description	Mill	Black	Brown	Weath'd Wood
2-1/2 in. x 2-1/2 in. x 7 in.	5X7FRM-ECON	963FRMBL	963FRMBR	-
2-1/2 in. x 2-1/2 in. x 7-5/8 in.	-	963FRMBLMET	963FRMBRMET	-
3 in. x 5 in. x 8 in.	-	-	3X5X8ALUM-BR	-
4 in. x 4 in. x 7 in.	4X4X7ALUM	-	-	-
4 in. x 4 in. x 8 in.	4X4X8STD	4X4X8ALUM-BL	4X4X8ALUM-BR	4X4X8ALUM-WW

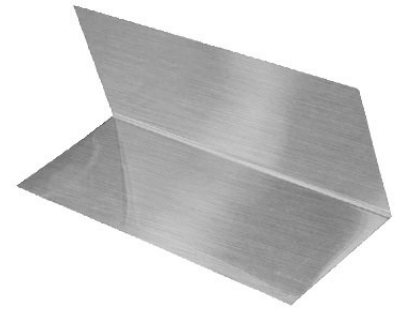

Steel Formed Shingles

0.012 in. Galvanized Steel

Description	Mill	Black	Royal Brown	Weathered Wood	No./Pkg.	Pkg./Pallet
2-1/2 in. x 2-1/2 in. x 7 in.	964FRM	-	-	-	100	100
2 in. x 4 in. x 8 in.	2X4X8GALV	2X4X8GALV-BL	2X4X8GALV-BR	2X4X8GALV-WW	100	100
4 in. x 4 in. x 8 in. (50 Bdl)	4X4X8-50	4X4X8GALVBL-50	4X4X8GALVBR-50	4X4X8GALVWW-50	50	-
4 in. x 4 in. x 8 in. (100 Bdl)	4X4X8-50	4X4X8GALV-BL	4X4X8GALV-BR	4X4X8GALV-WW	100	100
5 in. x 5 in. x 12 in.	5X5X12	-	-	-	10	-

Copper Formed Shingles

Description	Part #	QTY.
Copper Formed Shingles - 2-1/2 in. x 2-1/2 in. x 7 in.	939FRM	10/Bundle
Copper Formed Shingles - 4 in. x 4 in. x 8 in.	4X4X8COP	10/Bundle



SplashShield™ Rain Diverter

Description	Part #	QTY.
Royal Brown/White - Aluminum	SPLASHSHIELD	2/Bag



Kick-Out Flashing Used to divert water away from a wall and into a gutter. Usually installed on the bottom of a roof edge that intersects a wall surface.

Description	Part #	QTY.
Galvanized Steel Kick-Out Flashing - 4 in. x 4 in. x 8 in.	KICKFLASH	1/Bag





Flashings

Kwik-Plug™ Professionally repair holes left by old roof vents or roof deck damage up to 8 in. x 8 in.

Description	Part #	No./Carton	Cartons/Pallet
Kwik-Plug™ Steel/OSB Roof Repair	KWIKPLUG	12	108



Rain Diverter Directs water away from doorways on the roof where there is no gutter present.

Description	Part #	No./Carton	Cartons/Pallet
5 ft. Aluminum Rain Diverter - 0.016 in.	10.25RD	20	45

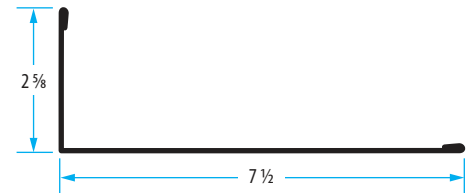

W-Valley Channels water down the roof into the gutters, in the roof valley area. Outer edges are hemmed for safe handling. 10 ft. lengths.

Steel W-Valley - 0.012 in. Galvanized Steel · Minimum order: 100 pcs.

Size	Black	Brown	Weathered Wood
18 in.	18WBL	18WBR	18WWW
20 in.	20WBL	20WBR	20WWW
20 in. - Ribbed	20WBL-R	20WBR-R	20WWW-R

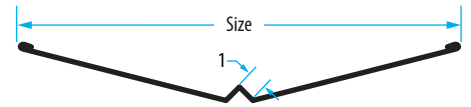

Heavy Duty Steel W-Valley - 0.015 in. Galvanized Steel · Minimum order: 100 pcs.

Size	Mill	Black	Hunter Green	Royal Brown	Weathered Wood
20 in.	20WHEAVY	20WBLHEAVY	20WHGHEAVY	20WBRHEAVY	20WWWHEAVY
24 in.	24WHEAVY	24WBLHEAVY	24WHGHEAVY	24WBRHEAVY	24WWWHEAVY
24 in. - Ribbed	24WHEAVY-R	24WBLHEAVY-R	-	-	4WWWHEAVY-R

Z-Flashing - Protects the top edge of siding sheets from water infiltration. 10 ft. lengths · Aluminum 0.019 in. (nom.) · 50 pieces per carton · 45 Cartons per pallet

Size: A x B	Mill	Polar White	Brown
3/8 in. x 1-1/8 in.	828A	828AWH	828ABR
5/8 in. x 7/8 in.	858A	858AWH	858ABR
3/4 in. x 3/4 in.	-	834AWH	-
7/8 in. x 1 in.	-	878AWH	878ABR

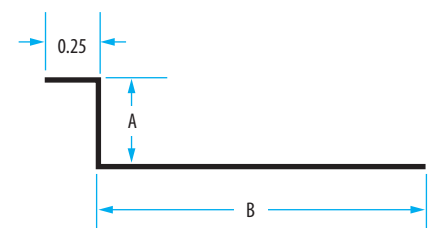



Trims and Edgings

A Edge Drip Edge that covers and protects the exposed edge of the roofline. 0.012 Galvanized Steel
10 ft. lengths · 25 per Carton

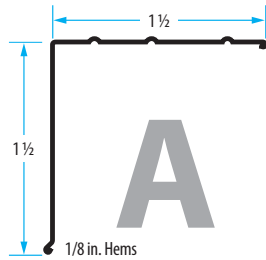

D Edge Drip Edge with shingle support that covers and protects the exposed edge of the roofline.
10 ft. lengths · 25 per Carton

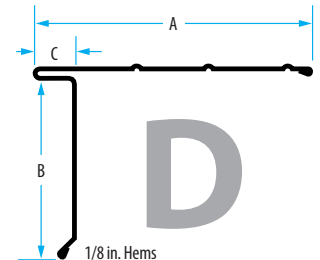

Description	Part #
1-1/2 in. x 1-1/2 in.	150A

Aluminum D Edge · Hemmed

Color	12 ft. Lengths					
	2-1/2 x 1 x 3/8	2-5/8 x 1-1/2 x 3/8	2-3/4 x 1-1/8 x 3/8	2-5/8 x 1-11/16 x 3/8	2-5/8 x 1-11/16 x 3/8	3 x 2 x 7/8
Almond	-	888DAL	-	-	ADE12-AL	-
Birch White	600DBWH	888DBWH	880DBWH	ADE10-WH	ADE12-WH	-
Black	600DBL	888DBL	880DBL	ADE10-BK	ADE12-BK	-
Charcoal	-	-	-	ADE10-COAL	-	-
Coffee	-	-	-	-	ADE12-CF	-
Copper Penny	-	-	-	-	ADE12-CP	-
Desert Tan	-	-	-	ADE10-DT	ADE12-DT	-
Driftwood	-	888DDW	-	-	ADE12-DW	-
Heritage Gray	-	-	-	-	ADE12-HGRAY	-
Hickory	600DHKY	888DHKY	880DHKY	-	ADE12-HKY	-
Hunter Green	-	-	-	ADE10-HG	ADE12-HG	-
Khaki	-	-	-	-	ADE12-MKHAKI	-
Musket Brown	-	-	880DMB	ADE10-MB	-	-
Pebblestone Clay	-	888DPB	-	-	-	-
Polar White	-	-	-	-	-	894DWH
Royal Brown	600DBR	888DBR	-	ADE10-RBR	ADE12-RBR	894DBR
Sandstone	-	888DSTONE	-	-	ADE12-STONE	-
Terra Bronze	-	-	-	ADE10-TB	ADE12-TB	-
Weathered Wood	600DWW	888DWW	880DWW	-	-	-

Galvanized D Edge · Hemmed

Color	Style 500						
	2-1/2 x 1-1/8 x 7/8	2-1/2 x 1-1/2 x 7/8	2-5/8 x 1-11/16 x 3/8	2-5/8 x 1-11/16 x 7/8	2-5/8 x 1-11/16 x 7/8	3 x 2 x 7/8	4 x 1-1/8 x 7/8
Mill Finish	890D	-	-	889DAL	-	-	-
Almond	890DAL	890DHEAVY-AL	-	-	891DAL	-	-
Birch White	-	-	SDE-WH	889DWH	-	-	-
Black	890DBL	-	-	889DBL	891DBL	-	-
Coffee	-	-	-	889DCF	-	-	-
Driftwood	890DWW	-	-	889DDW	-	-	-
Heritage Gray	-	-	-	-	-	-	-
Hickory	890DHKY	-	-	889DHKY	-	-	-
Hunter Green	890DHG	-	-	889DHG	-	-	-
Polar White	890DWH	890DHEAVY-PWH	-	-	891DPWH	892DWH*	893DWH*
Royal Brown	890DBR	890DHEAVY-BR	SDE-RBR	889DBR	891DBR	892DBR*	893DBR*
Weathered Wood	890DWW	890DHEAVY-WW	-	889DWW	891DWW	--	-

* 20/Carton



GUTTER APRON Directs water into the gutter system. Installed over the roof edge, extending into the gutter.
10 ft. lengths · 25 pieces per carton · 45 cartons per pallet

Aluminum Gutter Apron

Color	2-1/2 in. x 2 in.	3 in. x 2 in.
Almond	GA-AL	-
Birch White	GA-WH	GA2X3-BWH
Coffee	GA-CF	-
Driftwood	GA-DW	-
Heritage Gray	GA-HGRAY	-
Hunter Green	GA-HG	-
Hickory	GA-HKY	-
Khaki	GA-MKHAKI	-
Polar White	-	GA2X3-PWH
Royal Brown	GA-RBR	GA2X3-BR
Sandstone	GA-STONE	-
Terra Bronze	GA-TB	-

Galvanized Steel Gutter Apron

Color	2-3/8 x 2	3 in. x 2 in.
Almond	960AL	GGA2X3HEAVY-AL
Black	960BL	GGA2X3HEAVY-BL
Coffee	960CF	-
Driftwood	960DW	-
Hickory	960HKY	-
Hunter Green	960HG	GGA2X3HEAVY-HG
Polar White	960WH	GGA2X3HEAVY-PWH
Royal Brown	960BR	GGA2X3HEAVY-RBR
Weath'd Wood	960WW	GGA2X3HEAVY-WW

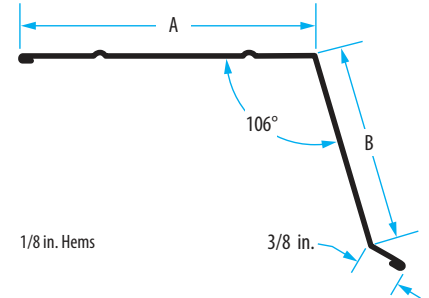

BRICK MOULDING Used as a protective and decorative cover for edgings of doorways and garage doors.
10 ft. lengths · 10 pieces per carton · 10 cartons per pallet

Color	Part#
Birch White	BM-WH
Coffee	BM-CF
Driftwood	BM-DW
Hickory	BM-HKY
Hunter Green	BM-HG
Royal Brown	BM-RBR
Terra Bronze	BM-TB

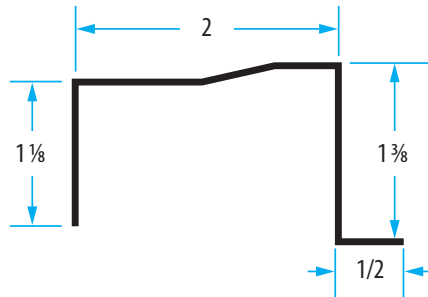



Aluminum Siding

HORIZONTAL SIDING Woodgrain Aluminum Siding used to beautify the exterior of your home.
0.019 Aluminum · 12 ft. 6 in. lengths · 12 pieces per carton/square · Minimum Order: Full Square

8 in. Aluminum Horizontal Siding

Color	8 in. Woodgrain Hollowback	8 in. Woodgrain Foamback	8 in. Smooth Hollowback*	8 in. Smooth Foamback*
Imperial Brown	8H19-IBR	8INS-IBR	-	-
Gray	8H19-GY	8INS-GY	-	-
Slate	8H19-SL	8INS-SL	-	-
Tan	8H19-TN	8INS-TN	-	-
White	8INS-WH	8INS-WH	8HS19-WH	8INSM19-WH

*Additional lead time may be required

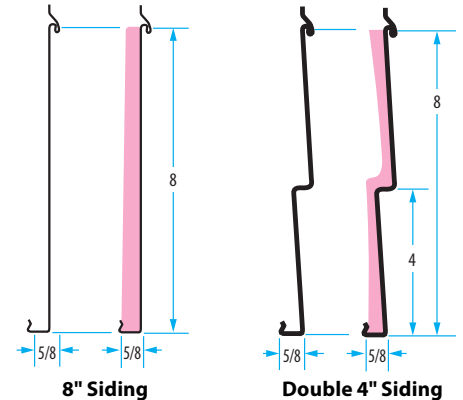

Double 4 in. Aluminum Horizontal Siding

Color	Woodgrain Hollowback	Woodgrain Foamback
Imp. Brown	DH19-IBR	D4INS-IBR
Gray	DH19-GY	D4INS-GY
Slate	DH19-SL	D4INS-SL
Tan	DH19-TN	D4INS-TN
White	DH19-WH	D4INS-WH

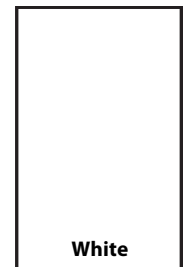
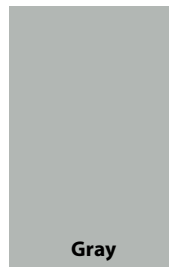

SIDING J-CHANNEL Used to trim around windows, doors and where siding meets the soffit or roof angle. 0.019 Aluminum · 12 ft. lengths

Color	5/8 in. Hollowback · 25/Carton	1-1/8 in. Foamback · 50/Carton
Imperial Brown	J58-IBR	J18-GY
Gray	J58-GY	J18-IBR
Slate	J58-SL	J18-SLL
Tan	J58-TN	J18-TN
White	J58-WH	J18-WH

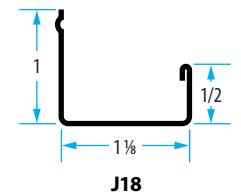
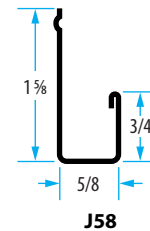

UNDERSILL TRIM

Designed to hold the cut edge of siding in place.
0.019 Aluminum · 12 ft. lengths · 50/Carton

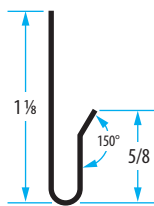

Color	Smooth Utility Trim
Imperial Brown	UTW-IBR
Gray	UTW-GY
Slate	UTW-SL
Tan	UTW-WH
White	UTW-TN

OUTSIDE CORNER POST

Woodgrain siding outside corner.
0.019 Aluminum · 10 ft. lengths · 10/Carton

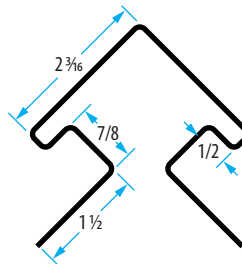

Color	Outside Corner Post
Imperial Brown	BP1-IBR
Gray	BP1-GY
Slate	BP1-SL
Tan	BP1-TN
White	BP1-WH

INSIDE CORNER POST

Smooth siding outside corner.
0.019 Aluminum · 10 ft. lengths · 10/Carton

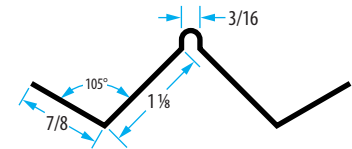

Color	Inside Corner Post
Imperial Brown	IC1-IBR
Gray	IC1-GY
Slate	IC1-SL
Tan	IC1-TN
White	IC1-WH



STARTER STRIP Used to hold first course of siding at the base of wall.
10 ft. lengths · Mill Finish · Sold individually

Description	Part#	No./Carton	Cartons/Pallet
Starter Strip - 0.016 Aluminum	2875SS	50	45
Starter Strip - 0.012 Galvanized Steel - 25	GSS25	25	45
Starter Strip - 0.012 Galvanized Steel	GSS	50	45
Starter Strip - 0.015 Galvanized Steel	3.5GSS	25	30

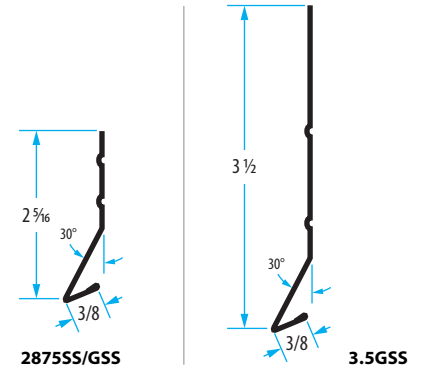

FOAM BACKER - R0.96

Description	Part #	No./Carton	Carton/Pallet
4 in. Foam Backer for Double 4 in. Siding	4FOM	-	-
8 in. Foam Backer for 8 in. Siding	8FOM	-	-

ENGINEERED WOOD SIDING CORNERS FOR HARDBOARD SIDING Individual aluminum corners for 7/16 inch hardboard siding.
0.019 Primed Aluminum · 100 pieces per carton · 100 cartons per pallet

Description	Part #
6 in. Primed Outside Corner - Smooth	1000
8 in. Primed Outside Corner - Smooth	1100
10 in. Primed Outside Corner - Smooth	1200
12 in. Primed Outside Corner - Smooth	2101
8 in. Primed Siding Corner - Smooth - XL	2108XL
8 in. Primed Siding Corner - Woodgrain - XL	2108XL-W
12 in. Primed Siding Corner - Smooth - XL	2110XL
12 in. Primed Siding Corner - Woodgrain -XL	2110XL-W
12 in. Primed Inside Corner - Smooth - 10/package	2110X-IS-10

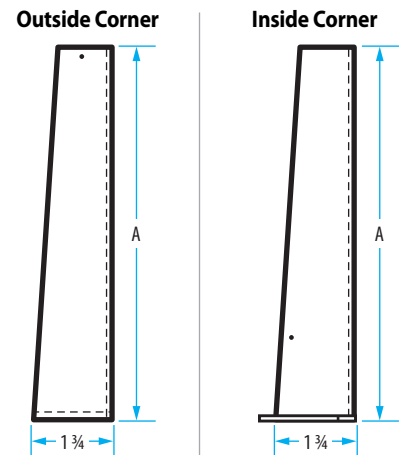

BACKFLASH Aluminum seam backer plate for fiber cement siding
0.012 Aluminum · 100 pieces per carton · 100 Cartons per pallet

Description	Part #
6 in. x 12 in. - Birch White over Royal Brown	BACKFLASH-EA

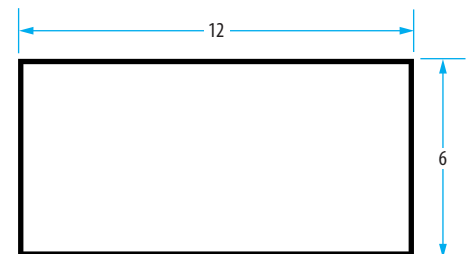



H-MOULDING FOR 7/16 IN. HARDBOARD SIDING

Aluminum H connectors for siding. 0.015 Primed Aluminum

Description	Part #	No./Carton	Carton/Pallet
6 in. Primed Aluminum - Woodgrain	6HW	200	100
8 in. Primed Aluminum - Smooth	8H	100	100
8 in. Primed Aluminum - Woodgrain	8HW	100	100
12 in. Primed Aluminum - Smooth	12H	100	100
12 in. - Primed Aluminum - Woodgrain	12H	100	100

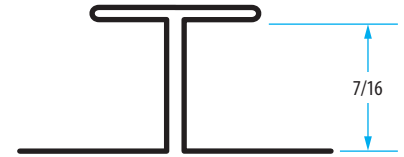

UNIVERSAL H-MOULDING FOR FIBER CEMENT

(5/16 in. - 3/8 in.) · 100 pieces per carton

Description	Part #
5-15/16 in. Primed Aluminum - Woodgrain	UH6W
7 in. Primed Aluminum - Woodgrain	UH7W
7-15/16 in. Primed Aluminum- Woodgrain	UH8W
10-15/16 in. Primed Aluminum - Woodgrain	UH11W
11-15/16 in. Primed Aluminum - Woodgrain	UH12W

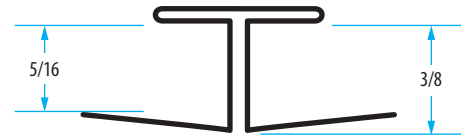

LONGER UNIVERSAL H-MOULDING FOR FIBER CEMENT

(5/16 in. - 3/8 in.)

25 pieces per carton

Description	Part #
8 in. Primed Aluminum - Smooth	UH8FT-PRM
8 in. Primed Aluminum - Woodgrain	UH8FTW-PRM
10 in. Primed Aluminum- Smooth	UH10FT-PRM
10 in. Primed Aluminum - Woodgrain	UH10FTW-PRM

INSTALLATION ESSENTIALS

Fiber Cement · SmartSide® Siding

LAP SIDING H-MOULDING DIVIDERS



BACK FLASH ALUMINUM SEAM BACKER PLATE



ANGLE FLASHING

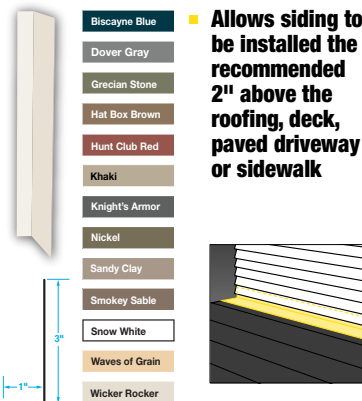

ALUMINUM TRIM COIL





PAINTED TRIM COIL Painted aluminum trim coil matches the soffit system and is used for custom flashing projects or hard-to-finish areas. Painted on both sides to satisfy any custom flashing requirements. 0.019 Aluminum - 1 roll per carton

14 in. x 50 ft. Trim Coil 0.019 Aluminum - 1 roll per carton - 64 Cartons/Pallet

Description	Part #
Birch White/Birch White - 14 in. x 50 ft.	ATC14-WH
Royal Brown/Birch White - 14 in. x 50 ft.	ATC24

24 in. x 50 ft. Trim Coil 0.019 Aluminum - 1 roll per carton - 48 Cartons/Pallet

Description	Part #
Almond/Birch White - 24 in. x 50 ft.	ATC24-AL
Birch White/Birch White - 24 in. x 50 ft.	ATC24-WH
Black/Birch White - 24 in. x 50 ft.	ATC24-BL
Black/Royal Brown - 24 in. x 50 ft.	ATC25-BL-BR
Coffee/Birch White - 24 in. x 50 ft.	ATC25-CF
Copper Penny/Birch White - 24 in. x 50 ft.	ATC24-CP
Desert Tan/Birch White - 24 in. x 50 ft.	ATC24-DT
Driftwood/Birch White - 24 in. x 50 ft.	ATC24-DW
Gray/Charcol - 24 in. x 50 ft.	ATC24-GY-COAL
Hunter Green/Birch White - 24 in. x 50 ft.	ATC24-HG
Hickory/Birch White - 24 in. x 50 ft.	ATC24-HKY
Light Maple/Natural Clay - 24 in. x 50 ft.	ATC24-LMAP-NCLY
Musket Brown/Birch White - 24 in. x 50 ft.	ATC24-MB
Khaki/Prairie Wheat - 24 in. x 50 ft.	ATC24-MKHA-PW
Pebblestone Clay/Birch White - 24 in. x 50 ft.	ATC24-PB
Royal Brown/Birch White - 24 in. x 50 ft.	ATC24-BR
Sandy Clay/Wicker Rocker - 24 in. x 50 ft.	ATC24-SNC-WRO
Sierra/Birch White - 24 in. x 50 ft.	ATC24-SR
Sandstone/Black - 24 in. x 50 ft.	ATC24-STON-BL
Sandstone/Slate Blue - 24 in. x 50 ft.	ATC24-STON-BL
Terra Bronze/Birch White - 24 in. x 50 ft.	ATC24-TB
Terra Bronze/Hickory - 24 in. x 50 ft.	ATC24-TB-HKY



PVC Coated 24 in. x 50 ft. Trim Coil 0.019 Aluminum - 1 roll per carton - 24 Cartons/Pallet

Description	Part #
Hickory - Textured - 24 in. x 50 ft.	APVC-HKY
Royal Brown - Textured - 24 in. x 50 ft.	APVC-RBR
Terra Bronze - Textured - 24 in. x 50 ft.	APVC-TB
White - Textured - 24 in. x 50 ft.	APVC-WH





Trim Coil & Roll Flashing

Economy Aluminum Roll Flashing

1 roll per carton · Nominal Thickness: 0.010

Description	Part#	Ctn/Pallet
6 in. x 10 ft.	999-10-6	36
10 in. x 10 ft.	999-10-10	36
12 in. x 10 ft.	999-10-12	36
14 in. x 10 ft.	999-10-14	36
20 in. x 10 ft.	999-10-20	36
24 in. x 10 ft.	999-10-24	36
6 in. x 50 ft.	999-50-6	25
10 in. x 50 ft.	999-50-10	25
12 in. x 50 ft.	999-50-12	25
14 in. x 50 ft.	999-50-14	25
20 in. x 50 ft.	999-50-20	25
36 in. x 50 ft.	999-50-36	25

Standard Aluminum Roll Flashing

1 roll per carton · Nominal Thickness: 0.012

Description	Part#	Ctn/Pallet
14 in. x 10 ft.	961-10-14	36
20 in. x 10 ft.	961-10-20	36
24 in. x 10 ft.	961-10-24	36
10 in. x 50 ft.	961-50-10	25
14 in. x 50 ft.	961-50-14	25
20 in. x 50 ft.	961-50-20	25
24 in. x 50 ft.	961-50-24	25



Painted Aluminum Roll Flashing

1 roll per carton · Nominal Thickness: 0.010

Brown/White	Part#	Pal
6 in. x 10 ft.	999BW-10-6	36
10 in. x 10 ft.	999BW-10-10	36
14 in. x 10 ft.	999BW-10-14	36
14 in. x 50 ft.	999BW-50-14	25
24 in. x 50 ft.	999BW-50-24	25
Terra Bronze/Black	Part#	Pal
14 in. x 10 ft.	999TBBL-10-14	25
14 in. x 50 ft.	999TBBL-50-14	25

Economy Galvanized Roll Flashing

1 roll per carton · Nominal Thickness: 0.010

Description	Part#	Ctn/Pallet
6 in. x 10 ft.	959-10-6	36
12 in. x 10 ft.	959-10-12	36
20 in. x 10 ft.	959-10-20	36
24 in. x 10 ft.	959-10-24	36
6 in. x 50 ft.	959-50-6	25
12 in. x 50 ft.	959-50-12	25
20 in. x 50 ft.	959-50-20	25
24 in. x 50 ft.	959-50-24	25
36 in. x 50 ft.	959-50-36	25

Standard Galvanized Roll Flashing

1 roll per carton · Nominal Thickness: 0.012

Description	Part#	Ctn/Pallet
10 in. x 10 ft.	969-10-10	36
14 in. x 10 ft.	969-10-14	36
16 in. x 10 ft.	969-10-16	36
20 in. x 10 ft.	969-10-20	36
24 in. x 10 ft.	969-10-24	36
10 in. x 50 ft.	969-50-10	25
12 in. x 50 ft.	969-50-12	25
14 in. x 50 ft.	969-50-14	25
16 in. x 50 ft.	969-50-16	25
20 in. x 50 ft.	969-50-20	25
24 in. x 50 ft.	969-50-24	25

Painted Steel Roll Flashing

1 roll per carton · Nominal Thickness: 0.012

Description	Part#	Pal
24 in. x 50 ft. - Black	969-50-24BL	25



Copper Roll Flashing

12 oz. · 6 rolls per carton

Description	Part#	Ctn/Pallet
6 in. x 10 ft.	939-10-6	45
20 in. x 10 ft.	939-10-20	45





WALL BRACING ICC Certified: Report # ESR-2990

Galvanized Steel - 0.030 nom. · 12 per carton · 45 cartons per pallet

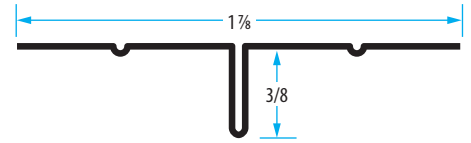

Description	Part #
1-7/8 in. x 3/8 in. x 11 ft. · 3-3/4 in. Galvanized Wall Brace - Mill Finish	11WB12

Heavy Duty Roof Brackets

10 per carton

Description	Part#
10 in. Adjustable	HD-2500
10 in. 45° Fixed	HD-2501
6 in. 90° Fixed	HD-2502



2500



2501



2502

Fall Protection Harnesses

Description	Part#
Seraph (M-L)	HD-11160
Cyclone (M-L)	HD-21042
Safety Bucket	HD-00815-QC



Adjustable Velocity HUV Harness,
50 ft. Vertical Lifeline Assembly
18 in. Lanyard Extension
Heavy-Duty Temper
Reusable Anchor



HD-11160



HD-21042

Life Lines & Lanyards

Description	Part #	QTY
50 ft. Vertical Lifeline Assembly	HD-01320	4
6 ft. Shock Absorbing Lanyard - Single Leg	HD-01220	1



HD-01320



HD-01220

Anchors

Description	Part #	QTY
Permanent Rooftop Anchor	HD-00510	10
Temporary Rooftop Anchor	HD-00455	10



HD-00510



HD-00455



Clean Mesh® Advanced gutter protection system. Stainless steel micro mesh is effective against small debris, including pine needles, seed pods and shingle grit. Fascia mount for 5 in. or 6 in. K-Style gutters. Available in 3 and 4 ft. lengths. Patent: 8,474,192



Description	Part#	QTY
5 in. width x 4 ft. length - Mill Finish	99377	25
5 in. width x 3 ft. length - Mill Finish	GP3SCREENM	32
6 in. width x 4 ft. length - Mill Finish	99375	25
6 in. width x 4 ft. length - Black Finish	99379	25

Kwik Mesh™

Galvanized - 1/8 in. mesh - 51.12 sq. in./ft. N.F.A.

Size	Part #	QTY.
6 in. x 25 ft.	KM625	6 rolls





Soffit, Fascia, Ventilation, Flashings, Trims & Edgings, Roll Flashing

(Not all items are available in all colors)



Almond (AL)



Birch White (BW)



Black (BL)



Coffee (CF)



Copper Penny (CP)



Desert Tan (DT)



Driftwood (DW)



Heritage Gray (HGRY)



Hickory (HK)



Hunter Green (HG)



Khaki (KH)

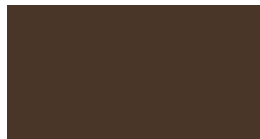

Musket Brown (MB)



Pebblestone Clay (PC)



Polar White (PWH)

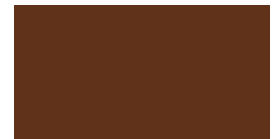

Royal Brown (RBR)



Sandstone (STONE)



Sierra (VA)



Terra Bronze (TB)



Weathered Wood (WW)

Aluminum Siding



Brown (BR)



Gray (GY)



Slate (SL)



Tan (TAN)



White (WH)



Sell-Even® Trim Coil Colors

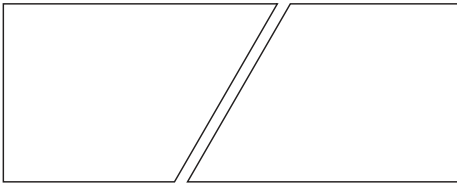

Birch White/Birch White #1573245

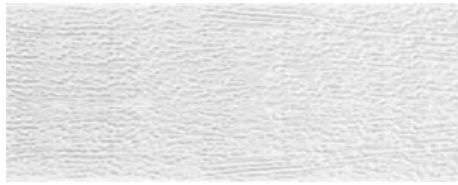

PVC Birch White #1573617



Royal Brown/Hunter Green #1573588

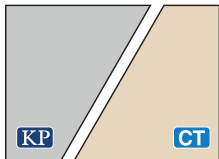

Heritage Gray/Desert Tan #1573382



Sandstone/Black #1573380



Terra Bronze/Hickory #1573400

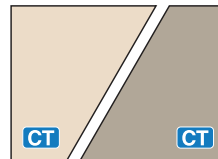

Light Maple/Natural Clay #1573386

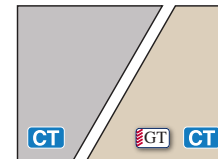

Ster. Gray/Savannah Wicker #1573588

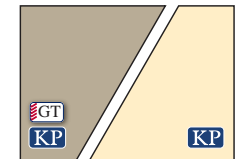

Khaki/Prairie Wheat #1573260



Almond/Birch White #1573484



Coffee/Birch White #1573592



Copper Penny/Birch White #1573589



Royal Brown/Birch White #1573279

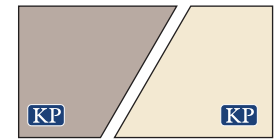

Clay/Antique Ivory #1573270



Brick/Evergreen #1573264

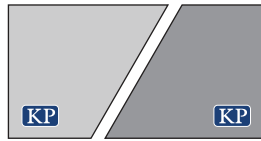

Gray/Charcoal #1573274

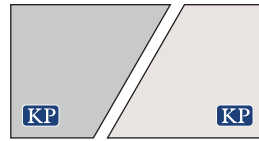

Heritage Gray/Classic Linen #1573250

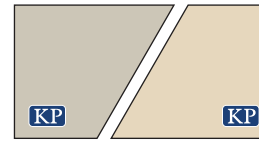

Pine/Almond #1573276

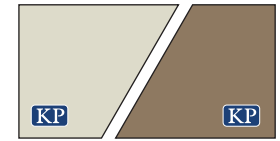

Sand/Pecan #1573268

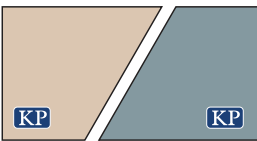

Sandstone/Slate Blue #1573255



Slate/Cobalt #1573272

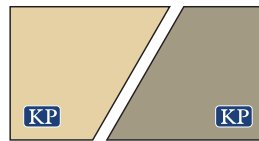

Tan/Cobblestone #1573266

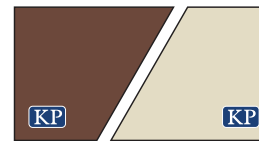

Umber/Sage #1573262

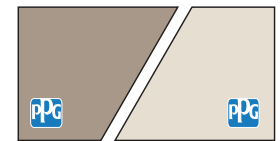

Sandy Clay/Wicker Rocker #1400310



Grecian Stone/Nickel #1400312



Biscayne Blue/Knights Armor #1400318

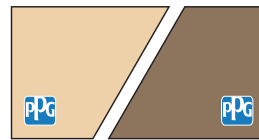

Waves of Grain/Hat Box Brown #1400316

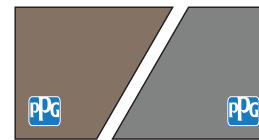

Smokey Sable/Dover Gray #1400319

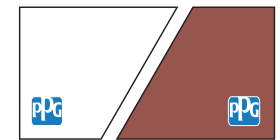

Snow White/Hunt Club Red #1400317



Arbor Mist/Bronze #1400309



Harbor Bay/Windswept Smoke #1573388





2-Panel Aluminum Soffit.....	3	Inside Corner Post	14
3-Panel Aluminum Soffit.....	4	J-Channel	7
4-Panel Aluminum Soffit.....	5	Kick-Out Flashing	10
Aluminum Fascia	6	Kwik Mesh™	20
Aluminum Roll Flashing.....	18	Kwik-Plug™.....	11
Aluminum Siding	14	Liberator	3
Angle Flashing.....	8	Life Lines & Lanyards.....	19
BackFlash.....	15	Outside Corner Post	14
Brick Moulding	13	Primed Siding Corner.....	15
Bucket of Safety	19	PVC Coated Trim Coil.....	17
Chimney Flashing Kit	8	PVC Coated Soffit	5
Chimney Flashing Reglet.....	8	Rain Diverter	11
Clean Mesh®	20	Roof Brackets	19
Copper Formed Shingles.....	10	Roof Starter.....	9
Copper Roll Flashing	18	Rooftop Anchors.....	19
Deck Flashing.....	8	Rooftop Safety Kit	19
Dormer Flashing	9	Siding J-Channel.....	14
Double Channel	7	Siding Starter Strip.....	15
Drip Cap	9	SplashShield™	10
Fall Protection.....	19	Steel Fascia.....	6
Flat Shingles	10	Step Flashing.....	10
Foam Backer	15	Style A Roof Edge	12
Formed Shingles.....	10	Style D Roof Edge.....	12
Frieze Runner	7	The Liberator	3
Frieze Runner - Reversible.....	7	Trim Coil.....	17
Galvanized Roll Flashing.....	18	Undersill Trim	14
Gutter Apron	13	Wall Brace.....	19
Gutter Protection.....	20	Wall Flash	9
Hardboard Siding Corners	15	W-Valley	11
H-Moulding	16	Z-Flashing.....	11





**CONSTRUCTION
METALS INC.**



PRODUCT CATALOG

**Trims & Flashing
Metal Roofing
Ventilation
Drywall Bead
Stucco & Plaster
Soffit & Fascia
Steel Framing
Gutter Protection
Safety Products**



www.gibraltarbuildingproducts.com

Professional Grade



AWARD METALS

1450 Virginia Ave., Baldwin Park, CA 91706
Tel: 626-814-4410 · Fax: 1.626.349.3114

CONSTRUCTION METALS INC.

1315 Vineland Ave., Baldwin Park, CA 91706
Tel: 909-390-9880 · Fax: 951-685-1165

NORWESCO/AWARD METALS

3011 70th Ave. E., Fife, WA 98424-3609
Tel: 800-426-0940 · Fax: 800-343-3063

DELIVERIES: 7 TO 10 BUSINESS DAYS

**TOLL FREE
CUSTOMER SERVICE**

800-426-0940

AK, ID, MT, OR, UT, WA

800-576-9810

AZ, CA, CO, HI, NV, WY

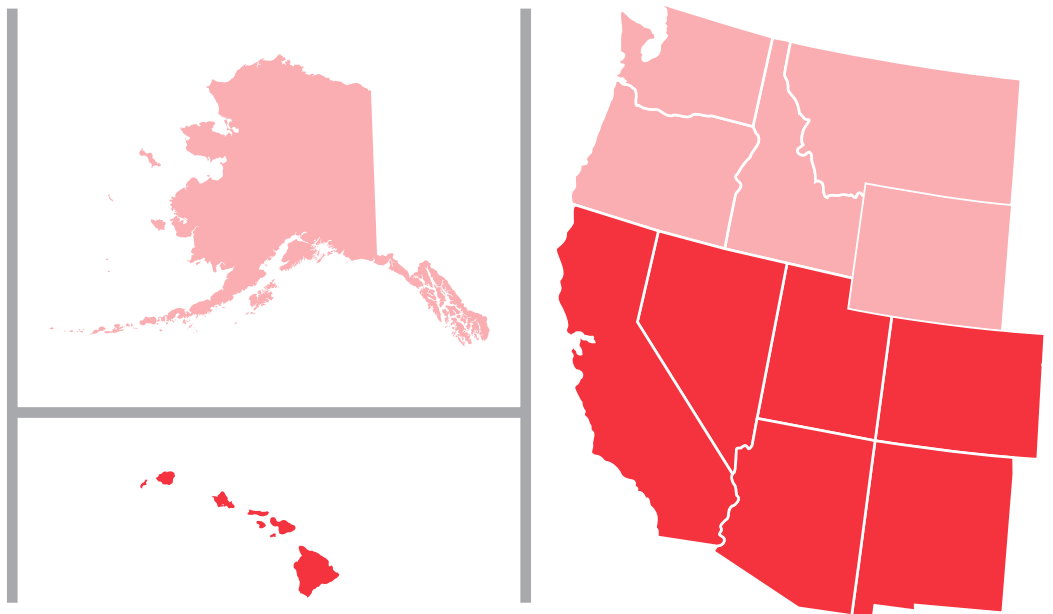

METAL ROOFING

- 2 1/2 in. Corrugated Panels 3
- PBR Panels 3
- SM-Rib Panels 3
- Ridge Cap 4
- Woodfast Screws 4
- Closure Strips 4
- Butyl Tape 4
- Fall Protection 4
- Moss Control Zinc Roll 4
- Roof Brackets 4

TRIMS & FLASHINGS

Roof Edge

- Drip Edge 5
- Painted Drip Edge 5
- Hemmed Drip Edge 6
- Grip Edge 6
- 3-Way Roof Edge 6
- Fascia Cap 6
- Gravel Stop 7
- T-Metal 7
- Roof Starter 7
- Style-D Roof Edge 8

Transition Flashing

- Eave Riser 8
- Tile Riser 8
- Tile Pan 8
- Saddle Stock 9
- Tile Hold Down Clip 9
- Bird Stop 9
- Counter Flashing 9
- L-Flashing, 90° 9
- Painted L-Flashing, 90° 10
- Roof to Wall 10
- W-Valley 11
- Z-Flashing 12
- Siding Corners 13

ROLL FLASHING

- Galvanized Rolls 14
- Aluminum Rolls 14
- Copper Barrier 15
- 7 inch Spool Rolls 15

FLAT STOCK & STEP FLASHING

- Flat Stock - 3 ft. x 4 ft. 15
- Flat Shingles 15
- Step Flashing 16

PIPE FLASHING

- Adjustable Pipe Flashing 17
- FHA Pipe Flashing 17
- Plumber's Flashing 18
- Scuppers 18
- Roof Outlet 18
- Flue Guard™ Chimney Cap 18

VENTILATION

Gable Louvers

- Rectangular Gable Louvers 19
- Bonderized Gable Louvers 19
- Copper Gable Louvers 19
- Round Gable Louvers 20
- Norwesco Reversible Vent 20

Rooftop Ventilation

- Econo Vent 20
- J-Vent 20
- T-Top 20
- Total Jack™ 20
- Vent Adapter 20
- Vent Cap 21
- Code Cap 21
- Dormer Vent 21
- Kwik Mesh™ 21
- Aluminum Mesh 21
- Stem Vent 22
- Stealth Vent® 22
- Static Vent 22

Side Wall Ventilation

- Access Doors 24
- Dryer Vent Cap 24
- Aluminum Louvered Vent 24
- Flat Screen Vent 24
- Two Way Vent 24
- Mini Louver 24

Eave & Soffit Ventilation

- Continuous Soffit Vent 25
- Soffit Vent 25
- Flush Mount Soffit Vent 25
- Eave Vent 25
- Vulcan Vent® 25

Foundation Ventilation

- Adjustable Foundation Vent 26
- Stamped Foundation Vent 26
- Rim Vent 26
- Damper Doors 26
- Foundation Vent Clips 26
- Foam Plugs 26
- Pour-In-Place Block Vent 26
- Galvanized Vent Wells 27
- Plastic Vent Wells 27

CONSTRUCTION HARDWARE

- Drywall Repair Squares 27
- Drywall Clips: Insta-Back 27
- Rain Diverter 27

DRYWALL CORNER BEAD PRODUCTS

Tape-On

- 90° Outside Corner 28
- 90° Inside Corner 28
- L-Trim 29
- Shadow Trim 30
- Reveal Trim 30
- J-Trim 30
- Bullnose Outside Corner 30

Paperfaced Nail-On

- 90° Outside Corner 31
- 90° Bullnose Outside Corner 31
- 3/4 in. Radius Kerf Bullnose 31

GUTTER

- Steel Fascia Gutter 33
- Conductor Heads 34
- Fascia Gutter Hangers 34
- K-Style Gutter 35
- Mitres & Connectors 35
- End Pieces & Drop Outlets 36
- Elbows 36
- Touch Up Paint 36
- Splash Shield™ 36
- K-Style End Caps 37
- K-Style Gutter Hangers 37
- Strainer 37
- Silicone Sealant 37
- Half Round Gutters 38
- Downspouts 38
- Downspout Straps 39
- Titebond® Sealant 39

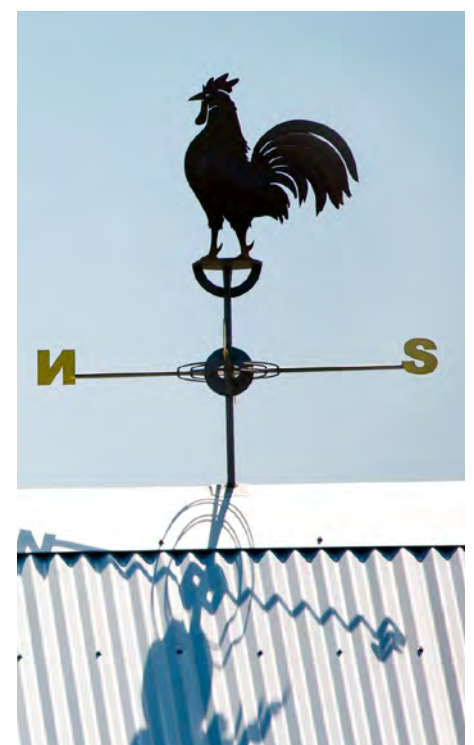

Corrugated exposed fastener roofing panel. 21-1/2 inch width roofing coverage. 24 inch width siding coverage.
Applications: Residential, Agricultural, Architectural, Light Commercial, Industrial

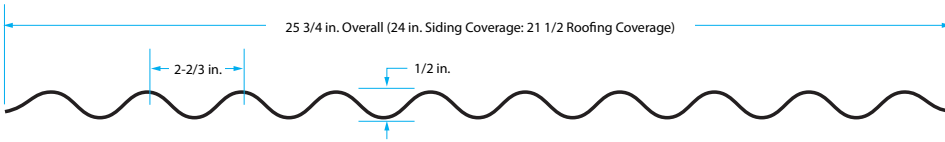

2 1/2" Corrugated Roofing Panels - Pack Quantity: 50

Description	29 Gauge	26 Gauge
6 ft.	CR6G-U	-
8 ft.	CR8G-U	13463
10 ft.	CR10G-U	13458
12 ft.	CR12G-U	13459
14 ft.	CR14G-U	-
16 ft.	CR16G-U	-

Code Approvals

UL Fire Resistant Directory #R20735
UL Listing Directory #R20735
Florida Building #FL-11175-R1



Underwriters Laboratories



G90, conforming to ASTM A446

PBR Panel exposed fastener roofing panel. 36 inch width coverage.
Applications: Residential, Agricultural, Architectural, Light Commercial, Industrial

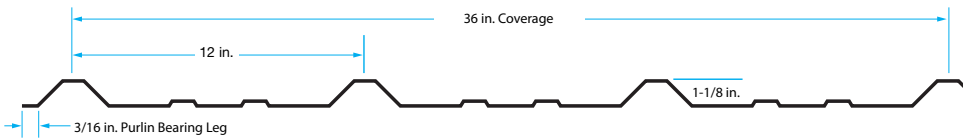

PBR Panels - Pack Quantity: 50

Description	26 Gauge
8 ft.	PBR8G-26
10 ft.	PBR10G-26
12 ft.	PBR12G-26

Testing Data & Specifications

Accelerated testing 2000 hours - ASTM G23
Salt Spray testing 1000 hours - ASTM B117
Fire Testing - ASTM E108 or UL 790
Wind Driven Rain - TAS 100

Code Approvals

UL Fire Resistant #R20735 · Florida Building #FL-11175

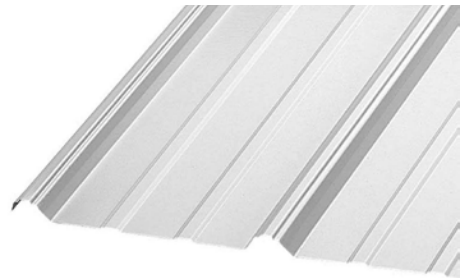

Underwriters Laboratories



SM-Rib exposed fastener siding panel. 36 inch width coverage.
Applications: Residential, Agricultural, Light Commercial, Industrial



Size	Cotton White	Forest Green
8 ft.	SM8CW	SM8FG
10 ft.	SM10CW	SM10FG
12 ft.	SM12CW	SM12FG

29 Gauge

Code Approvals

UL Fire Resistant Directory #R20735
Miami Dade: N.O.A. No. 09-0630.11
Florida Building #FL-11175

Testing Data & Specifications

Accelerated testing 2000 hours - ASTM G23
Salt Spray testing 1000 hours - ASTM B117
Fire Testing - ASTM E108 or UL 790
Wind Driven Rain - TAS 100



Underwriters Laboratories



1. For the most recent code approval numbers, contact Gibraltar Building Products Technical Department or refer to the appropriate code agency.

Ridge Cap Flashing for hip and ridge roof sections. For shingle or metal roof applications. 10 ft. lengths · Galvanized Steel · Pack Quantity: 10

Description	Part #
10 in. Corrugated Ridge Cap	CRC10G

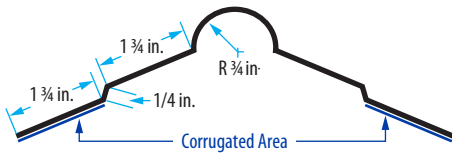

Woodfast Screws Galvanized #10 Hex-Head with neoprene gasket and self-piercing tip. 100 per bag · 10 bags per carton

Description	Part #
#10 x 1-1/2 in. Woodfast Screw	34166



Closure Strips Foam closure strips have a self-adhesive backing for ease of installation. Pack Quantity: 100

Description	Part #
Corrugated Closure	CLS24
PBR Inside	PBRCLSIN-EA
PBR Outside	PBRCLSOUT-EA
SM-Rib Inside	SMCLSIN-5
SM-Rib Outside	SMCLSOUT-5

Butyl Tape used to seal metal-to-metal connections. 32 rolls per carton

Description	Part #
50 ft. Butyl Tape	99415



Heavy Duty Roof Brackets for safety on the jobsite. 10 brackets per carton

Description	Part #
10 in. - Adjustable	HD-2500
10 in. - 45°	HD-2501
6 in. - 90°	HD-2502



Moss Control Roll Zinc strip to prevent moss from growing. 6 rolls per carton

Description	Part #
2-1/2 in. x 50 ft. with nails	MB50
2-1/2 in. x 50 ft. without nails	519124



HUV Harness Cyclone Full Body - M-L



HD-21042 · QTY: 5

Safety Kit

Universal Fit Harness, Temper Anchor, Shock Absorber Lifeline, Training Video - online



HD-00815-QC · QTY: 3



Seraph Harness

Universal Fit



HD-11160 · QTY: 5

6 ft. Shock Absorbing Lanyard



HD-01220 · QTY: 6

50 ft. Lifeline

Heavy duty poly rope resists cuts, abrasions, water absorption. Attached self locking carabineer



99422 · QTY: 4

Roof Anchors

Reusable Temper Roof Anchor



HD-00455 · QTY: 10

Permanent Double D Roof Anchor



HD-00510 · QTY: 10

Bare Metal Drip Edge 10 ft. lengths · Pack Quantities: 20

Galvanized: A x B	30 Ga.	28 Ga.	28 Gauge Bonderized	
1 in. x 2 in.	-	RE12G	1 in. x 2 in.	RE12B
1-3/8 in. x 1-3/4 in.	516764	-	1-1/2 in. x 1-1/2 in.	RE15B
1-1/2 in. x 1-1/2 in.	-	RE15G	2 in. x 3 in.	RE23B
2 in. x 3/4 in.	516765	-	16 oz. Copper	
2 in. x 2 in.	-	RE22G	1-1/2 in. x 2 in.	RE152CPR
2 in. x 2 in. PNW	-	516793	2 in. x 2 in.	RE22CPR
2 in. x 3 in.	-	RE23G	Zinc: A x B	
2 in. x 4 in.	-	RE24G	1-1/2 in. x 1-1/2 in.	RE15Z
2 in. x 8 in.	-	RE28G	2 in. x 2 in.	RE22Z
3 in. x 3 in.	-	RE33G	2 in. x 4 in.	RE24Z
6 in. x 6 in.	-	RE66G		RE15Z-26
				RE22Z-26
				RE24Z-26

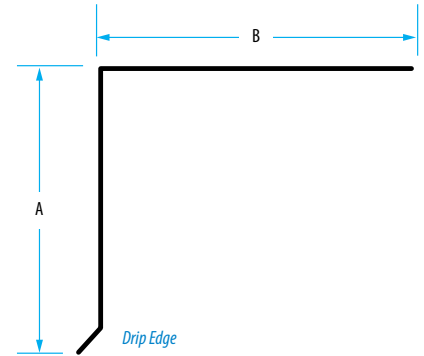

Painted Drip Edge 10 ft. lengths · Pack Quantities: 20

30 Gauge: A x B	Black	Dark Brown	Gray	White
1-3/8 in. x 1 in.	-	517978	-	-
1-3/8 in. x 1-3/8 in.	-	-	-	517979
1-3/8 in. x 1-3/4 in.	516564	516864	516664	516964
2 in. x 3/4 in.	-	516865	-	-
2 in. x 1-1/2 in.	-	516346	-	-
2 in. x 2 in. PNW	517776	516876	517966	516976
3 in. x 2 in.	-	-	517781	-
3 in. x 3 in.	-	-	-	516982

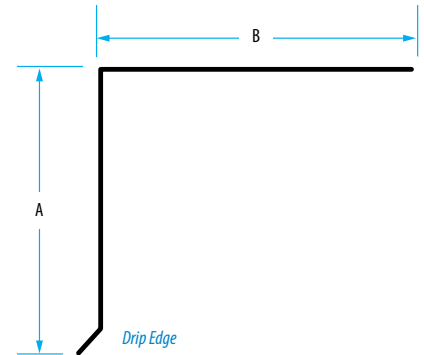

28 Gauge: A x B	Black	Brown	Charcoal	D. Brown	Gray	R. Brown	White
1 3/8 in. x 1 in.	516121	-	-	-	-	-	-
1 3/8 in. x 1 3/8 in.	-	-	-	517514	-	-	-
1-1/2 in. x 1-1/2 in.	RE15BL	RE15BR	RE15CH	RE15BRW	RE15GR	RE15BRU	RE15WH
2 in. x 1 1/8 in.	-	-	-	517426	-	-	517186
2 in. x 1-1/2 in.	-	-	-	517191	-	-	517185
2 in. x 2 in.	-	RE22BR	RE22CH	RE22BRW	-	RE22BRU	RE22WH
2 in. x 3 in.	-	RE23BR	RE23CH	RE23BRW	-	RE23BRU	RE23WH
2 in. x 4 in.	-	RE24BR	RE24CH	-	-	-	RE24WH
3 in. x 3 in.	-	RE33BR	RE33CH	RE33BRW	-	-	RE33WH
4 in. x 1-3/8 in.	-	-	-	517046	-	-	-

26 Gauge: A x B	Black	Brown	Charcoal	D. Brown	Gray	White
1-3/8 in. x 1-3/4 in.	516172	-	-	516170	516173	516171
1-1/2 in. x 1-1/2 in.	-	-	-	-	-	RE15WH-26
2 in. x 2 in.	-	RE22BR-26	RE22CH-26	-	-	RE22WH-26
2 in. x 2 in. PNW	517969	-	-	517967	517949	517229
2 in. x 4 in.	-	RE24BR-26	-	-	-	RE24WH-26
5 in. x 3 in.	517710	-	-	-	-	-

Hemmed Roof Edge 28 Gauge · 10 ft. lengths · Pack Quantity: 10

RE Style

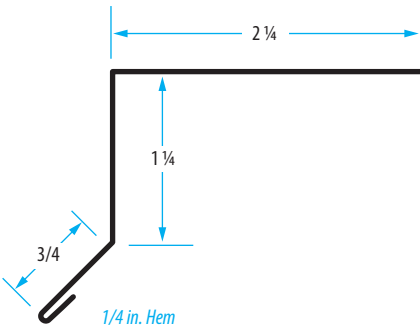

Finish	Part #
Galvanized	RE90G
Black	RE90BL
Clay	RE90CL
Royal Brown	RE90BRU
Sand	RE90SND
Tan	RE90TN
White	RE90WH

REL Style

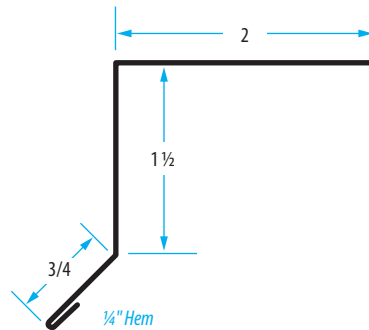

Finish	Part #
Galvanized	REL90G
Black	REL90BL
Royal Brown	REL90BRU
White	RE90WH

Special 90

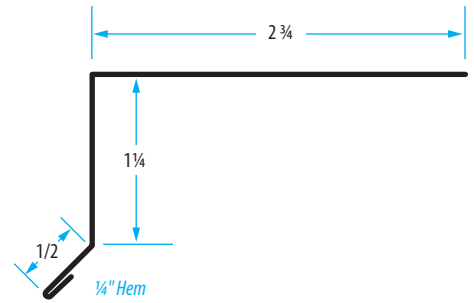

Finish	Part #
Dark Brown	516837
White	516937

Grip Edge 28 Gauge · 10 ft. lengths · Pack Quantity: 30

Size: A x B	Galvanized	Brown	Charcoal	White
1 in. x 2 in.	GE12G	-	-	-
1-1/2 in. x 1-1/2 in.	GE15G	GE15BR	GE15CH	GE15WH
2 in. x 2 in.	GE22G	GE22BR	GE22CH	GE22WH
2 in. x 3 in.	-	-	-	GE23WH

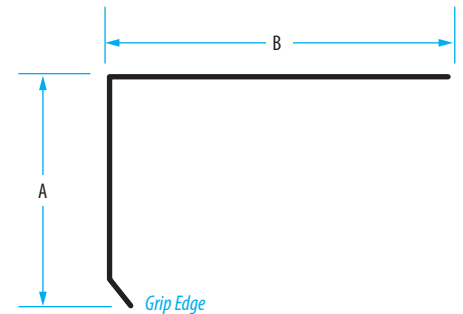

3-Way Roof Edge 28 Gauge · 10 ft. lengths · Pack Quantity: 10

Material	Part #
Bonderized Steel	3W4B
Brown Painted Steel	3W4BR
White Painted Steel	3W4WH

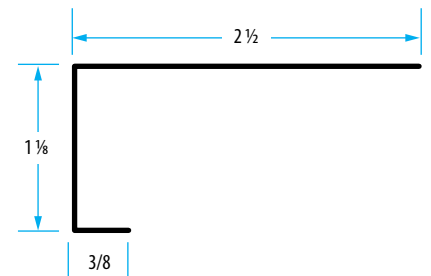

Fascia Cap 28 Gauge · 10 ft. lengths · Pack Quantity: 10

Color	Part #
Dark Brown	FC2BRW

Protects roof edges by diverting water away from a wooden fascia board. The lower face has a drip edge; the upper face has a grip edge.

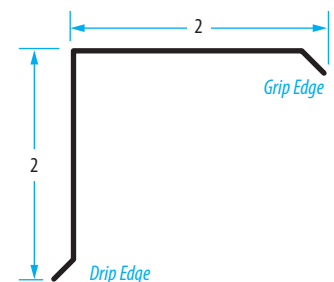

Bare Metal Gravel Stop 28 Gauge · 10 ft. lengths · Pack Quantity: 10

Size: A x B	Galvanized	Bonderized	Zinc
2 in. x 4 in. + 1/4" rise	-	-	CS24Z
2 in. x 4 in. + 1/2" rise	-	GS24B	-
2 1/4 in. x 2 in. + 5/8" rise	516769	-	-
3 in. x 3 in. + 1/4" rise	-	-	CS33Z
3 in. x 3 in. + 1/2" rise	GS33G	-	-
3 in. x 4 in. + 1/4" rise	CS34G	-	-
4 in. x 4 in. + 1/2" rise	-	GS44B	-

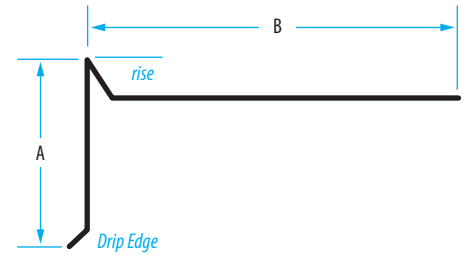

Painted Gravel Stop 28 Gauge · 10 ft. lengths · Pack Quantity: 10

Size: A x B	Brown	White
2 in. x 4 in. + 1/8" rise	CS2418BR	CS2418WH
2 in. x 4 in. + 1/4" rise	CS24BR	-
2-1/4 in. x 2 in. + 5/8" rise	-	517770
3 in. x 3 in. + 1/4" rise	CS33BR	-

26 Gauge Gravel Stop 10 ft. lengths · Pack Quantity: 10

Size: A x B	Galvanized	Zinc	Black	White
2 in. x 4 in. + 1/8" rise	CS2418G-26	-	-	CS2418WH-26
2 in. x 4 in. + 1/4" rise	-	CS24Z-26	-	-
2-1/4 in. x 2 in. + 5/8" rise	-	-	517870	-

Grip Edge Gravel Stop 28 Gauge · 10 ft. lengths · Pack Quantity: 10

Size: A x B	Galvanized
2 in. x 4 in. + 1/2" rise	GEGS24G
4 in. x 4 in. + 1/2" rise	GEGS44G

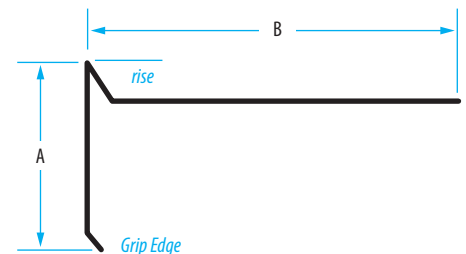

T-Metal 10 ft. lengths · Pack Quantity: 10

	Black	Dark Brown	Gray	White
A - 26 Gauge	TMETBL-26	TMETBRW-26	516228	516226
A - 30 Gauge	516675	516875	-	-
B - 26 Gauge	517203	517201	517207	517204

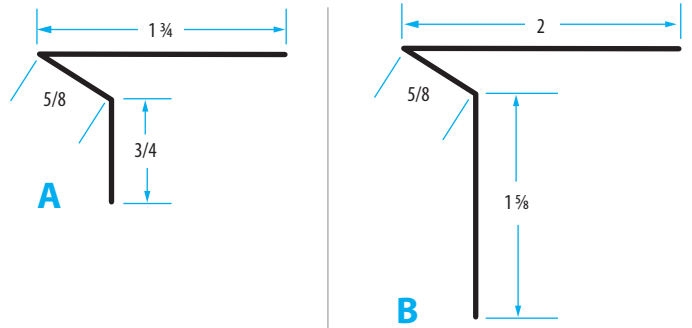

Roof Starter #230 10 ft. lengths · Pack Quantity: 10

Gauge	Galvanized	Stainless	Black	Dk. Brown	White
28	RSG	RSSS	516670	516860	516960
26	-	-	517132	517130	517131

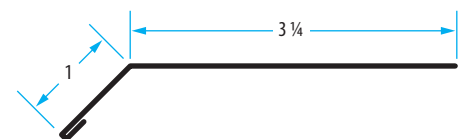

Style-D Eave Drip 10 ft. lengths · Pack: 25

28 Gauge - No Hem	
Galvanized	SDG
Black	SDBL
Brown	-
Dark Brown	SDBRW
Gray	SDGR
Royal Brown	SDBRU
White	SDWH

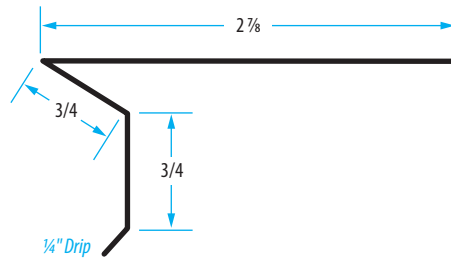

26 Gauge - No Hem	
Galvanized	-
Black	-
Brown	SDBR-26
Dark Brown	-
Gray	-
Royal Brown	-
White	SDWH-26

30 Gauge - Hemmed	
Galvanized	516763
Black	516663
Brown	-
Dark Brown	516863
Gray	517963
Royal Brown	-
White	516963

28 Gauge - Hemmed	
Galvanized	516563
Brown	-
Dark Brown	516878
Gray	516895
Royal Brown	-
White	516978

26 Gauge - Hemmed	
Galvanized	-
Black	517970
Brown	-
Dark Brown	517980
Gray	-
Royal Brown	-
White	517990

Tile Riser Galvanized Steel · 10 ft. lengths · Pack Quantity: 10 · 4:12 Pitch · Weep & Nail Holes

Color	28 Gauge	26 Gauge
Charcoal	3TR1.5C28	3TR1.5C26
Brown	3TR1.5BR28	3TR1.5BR26

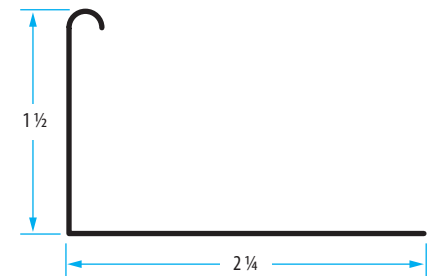

Tile Pan 26 Gauge Galvanized Steel
10 ft. lengths · Pack Quantity: 10

Size: A x B x C	Galvanized
3-1/2 in. x 6 in. x 1/2 in.	TP10G-26
4 in. x 6 in. x 1 in.	TP11G-26
4 in. x 6 in. x 1 in. - 45°	TP11G-26-45
4 in. x 7 in. x 1 in.	TP12G-26
4 in. x 7 in. x 1 in. - 45°	TP12G-26-45
6 in. x 8 in. x 1 in. - 45°	TP15G-26-45
6 in. x 8 in. x 1 in. - 45°*	TP15G1R-26-45

Tile Pan 26 Gauge Zinc
10 ft. lengths · Pack Quantity: 10

Size: A x B x C	Zinc
3-1/2 in. x 6 in. x 1/2 in.	TP10Z-26
4 in. x 6 in. x 1 in.	-
4 in. x 6 in. x 1 in. - 45°	-
4 in. x 7 in. x 1 in.	TP12Z-26
4 in. x 7 in. x 1 in. - 45°	TP12Z-26
6 in. x 8 in. x 1 in. - 45°	-
-	-

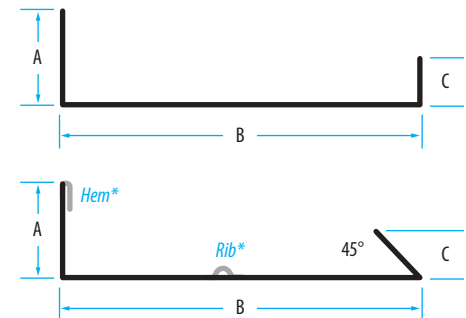

* Hem + Rib

3-1/2 in. x 6 in. x 1/2 in. - 28 Gauge	TP10G
--	-------

Saddle Stock Galvanized Steel · 10 ft. lengths

Size: A x B	Galvanized	Black	Dark Brown	Gray	QTY
4 in. x 14 in. - 28 Ga.	SS414G	-	-	-	10
4 in. x 14 in. - 26 Ga.	SS414G-26	-	-	-	10
5 in. x 13 in. - 28 Ga.	-	517772	518772	-	5
5 in. x 13 in. - 26 Ga.	-	517786	517784	517787	5

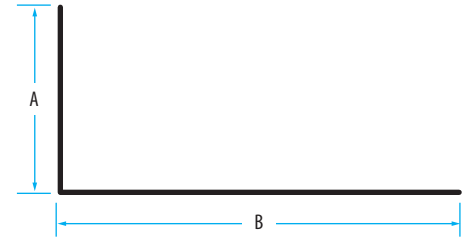

Bird Stop 30 Gauge · Pack Quantity: 10

	Charcoal	Red
Capistrano	3BSC30EC11	3BSR30EC
Malibu	3BSC30EM11	3BSR30EM11
Maxi Tile	-	3BSR30MXT-5
M. Mission	3BSC30MS	-
Barcelona	3BSC30LB	3BSR30LB
Espana	3BSC30LE	3BSR30LE
Villa	3BSC30MV	3BSR30MV

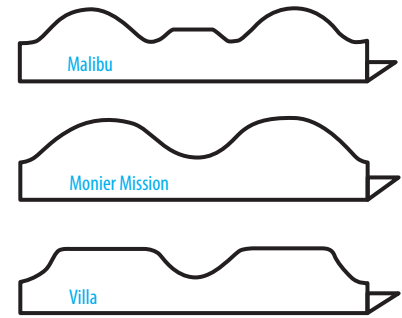
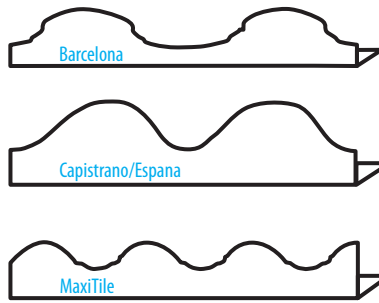

Counter Flashing 26 Gauge · 10 ft. lengths · Pack Quantity: 10

Size: A x B	Galvanized	Zinc
3 in. x 1/2 in.	-	3CTF.53Z26
5 in. x 1/2 in.	3CTF.53Z26	3CTF.55Z26
6 in. x 1/2 in.	-	3CTF.56Z26

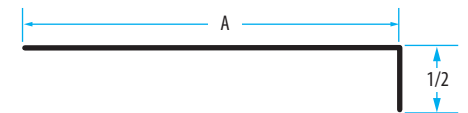

Bare Metal L-Flashing Pack Quantity: 20

Size: A x B	Galvanized		Bonderized		Zinc
	30 Ga.	28 Ga.	26 Ga.	28 Ga.	28 Ga.
1 in. x 1 in.	516707	-	-	-	-
1 in. x 1-1/2 in.	516702	LF115G	-	-	-
1-1/2 in. x 1-1/2 in.	516704	LF15G	-	-	-
1 in. x 2 in.	516703	LF12G	-	-	-
1 in. x 3 in.	-	516752	-	-	-
2 in. x 2 in.	-	LF22G	-	-	-
2 in. x 3 in.	-	LF23G	-	-	-
2 in. x 4 in.	-	LF24G	-	-	-
3 in. x 3 in.	-	LF33G	-	LF33B	-
3 in. x 4 in.	-	516750	-	-	-
3 in. x 5 in.	-	-	-	-	LF35Z
4 in. x 4 in.	-	LF44G	-	-	-
4 in. x 5 in.	-	LF45G	-	-	-
4 in. x 6 in.	516695	LF46G	LF46G-26	-	LF46Z
6 in. x 6 in.	-	LF66G	-	-	-

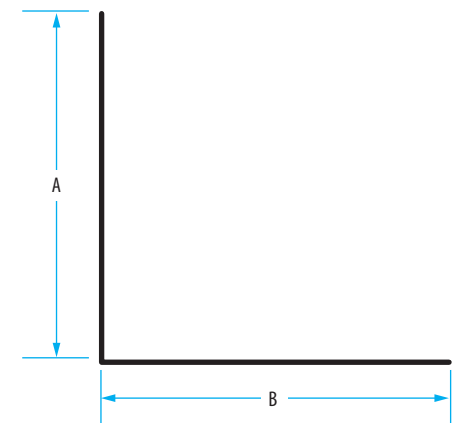

Painted L-Flashing Pack Quantity: 20

Size: A x B	Black		Dark Brown		White	
	30 Ga.	28 Ga.	30 Ga.	28 Ga.	30 Ga.	28 Ga.
1 in. x 1.5 in.	-	-	516802	-	516902	-
1.5 in. x 1.5 in.	-	-	516804	LF15BRW	516904	-
1 in. x 2 in.	-	-	516803	-	516903	-
1 in. x 3 in.	-	-	516852	-	516952	-
2 in. x 2 in.	-	-	516805	LF22BRW	516905	-
2 in. x 3 in.	516653	-	516853	LF23BRW	516953	-
2 in. x 4 in.	-	-	516846	-	516946	-
3 in. x 3 in.	-	-	516806	-	516906	-
3 in. x 5 in.	-	-	-	516857	-	-
4 in. x 4 in.	-	516608	-	516808	-	516908
4 in. x 6 in.	-	-	-	820406	-	LF46WH
6 in. x 6 in.	-	-	-	516809	-	-

Size: A x B	Dark Brown	Gray
26 Gauge L-Flashing 2 in. x 2 in.	LF22BRW-26	517220

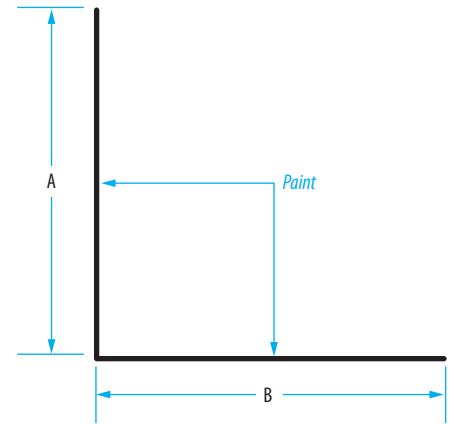

Bare Metal Roof to Wall 10 ft. lengths · Pack Quantity: 10

A x B	Galvanized		Bonderized	Zinc	
	28 Gauge	26 Gauge	28 Gauge	28 Gauge	26 Gauge
2 in. x 3 in.	RW23G	RW23G-26	-	-	-
2 in. x 4 in.	-	-	-	-	RW24Z-26-110
2 in. x 6 in.	RW26G	-	RW26B	-	RW26Z-26-110
3 in. x 5 in.	RW35G	-	-	RW35Z-110	-
4 in. x 4 in.	-	-	-	-	RW44Z-26-110
4 in. x 5 in.	RW45G-120*	-	-	-	-
4 in. x 6 in.	RW46G	RW46G-26	-	-	RW46Z-26-110

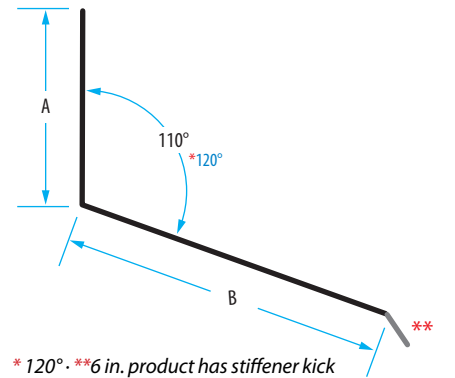

9/12 Roof to Wall 10 ft. lengths · Pack Quantity: 10

Description	Black	Brown
1 in. x 3 in. - 9/12 Pitch · 26 Gauge	517123	517121
3 in. x 5 in. - 9/12 Pitch · 26 Gauge	516260	516261

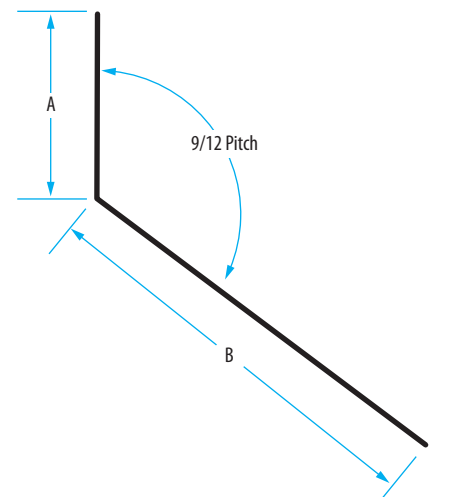

30 Gauge Painted Roof to Wall 10 ft. lengths · Pack Quantity: 20

Size: A x B	Black	Dark Brown	Gray	White
1 in. x 3 in.	516655	516847	517947	516947
6 in. x 6 in.	-	-	-	516683

28 Gauge Painted Roof to Wall 10 ft. lengths · Pack Quantity: 20

Size: A x B	Black	Dark Brown	White
3 in. x 5 in.	RW35BL	RW35BRW	516956
4 in. x 4 in.	516610	516810	516910
4 in. x 6 in.	-	516511	-
6 in. x 6 in.	-	516812	-

26 Gauge Painted Roof to Wall 10 ft. lengths · Pack Quantity: 20

Size: A x B	Black	Brown	Dark Brown	Gray	White
1 in. x 3 in.	516215	-	516213	516216	516214
2 in. x 3 in.	516219	-	516217	-	-
3 in. x 5 in.	516223	-	516221	517956	-
4 in. x 4 in.	RW44BL	-	RW44BRW	-	-
4 in. x 6 in.	-	RW46BRIN-26	-	-	-

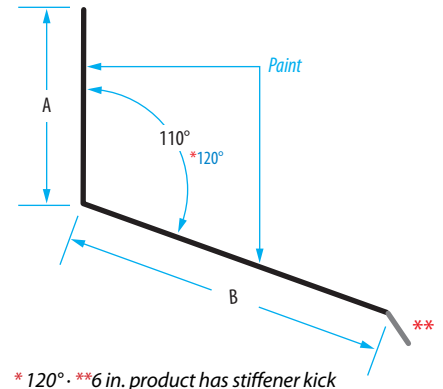

* 120°. **6 in. product has stiffener kick

28 Gauge W-Valley 10 ft. lengths · Pack Quantity: 10

Description	Galv.	Zinc	Black	Brown	Charcoal	D. Brown	White
18 in. - Hemmed	V18G	-	-	V18BR	V18CH	V18BRW	V18WH
24 in. - Hemmed	V24G	V24Z	V24BL	V24BR	-	V24BRW	-

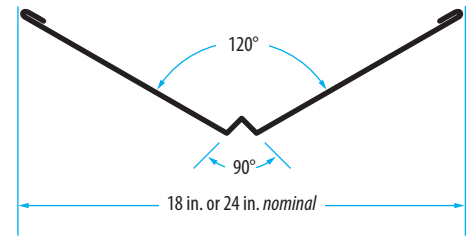

26 Gauge W-Valley 10 ft. lengths · Pack Quantity: 10

Description	Galv.	Black	Brown	D. Brown	Gray	W. Wood
18 in. - No Hem	-	516239	-	516237	-	-
20 in. - No Hem	-	-	V20NR-26-NH	-	-	V20WGR-26
24 in. - Hemmed	V24G-26	516247	V24BL	516253	516257	V24WGR-26

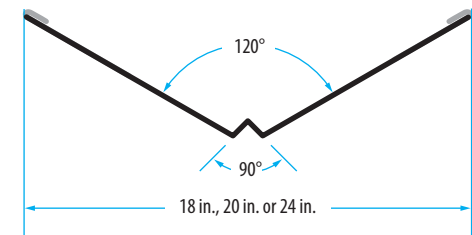

Zinc W-Valley 26 Gauge · 10 ft. lengths · Pack Quantity: 10

Description	Part #
18 in. Hemmed	V18Z-26
18 in. No Hem	V18ZNH-26
24 in. Open Hem	V24GOH-26
24 in. 3 Rib, Hemmed	V24Z3R-26
24 in. 5 Rib, Open Hem	V24Z5ROH-26
24 in. Hemmed	V24Z-26

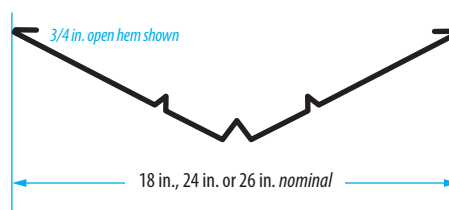

Tile Valley

28 Gauge · 10 ft. lengths · Pack Quantity: 10

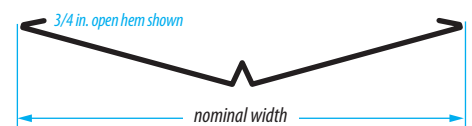

Description	Part #
24 in. - Dark Brown	518751

30 Gauge Z-Flashing 10 ft. lengths · 30 Gauge Galvanized Steel · Pack Quantity: 20

Size: A x B x C	Galvanized	Bonderized	Dark Brown	White
1/4 in. x 1-1/4 in. x 1 in.	516766	-	516866	516966
1/4 in. x 1-1/2 in. x 1 in.	516786	-	516886	516986
1/4 in. x 1-5/8 in. x 1 in.	-	-	516896	-
3/8 in. x 1/2 in. x 2 1/8 in.	-	517757	-	-
3/8 in. x 5/8 in. x 2 in.	-	517921	-	-
3/8 in. x 1 in. x 3/4 in.	870125	-	820290	516927
3/8 in. x 1-1/8 in. x 3/4 in.	820067	-	820294	516915
3/8 in. x 2 in. x 3/4 in.	-	-	516836	-

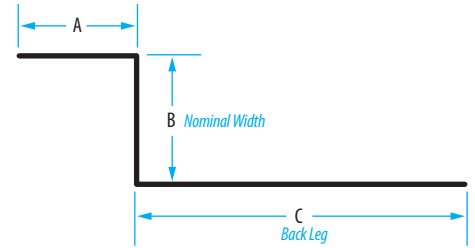

28 Gauge Z-Flashing 10 ft. lengths · 28 Gauge Galvanized Steel · Pack Quantity: 20

Size: A x B x C	Galvanized	Bonderized	Brown	Dark Brown	White
1/4 in. x 1-1/4 in. x 2 in.	-	-	-	-	517198*
3/8 in. x 5/16 in. x 2-1/4 in.	516724	-	-	-	-
3/8 in. x 3/8 in. x 2 in.	SZB38G	-	SZB38BR	516821	SZB38WH
3/8 in. x 7/16 in. x 2-1/4 in.	SZB716G	SZB716B	-	-	-
3/8 in. x 1/2 in. x 2-1/8 in.	SZB12G	-	-	SZB12BRW	516958
3/8 in. x 5/8 in. x 2 in.	SZB58G	SZB58B	SZB58BR	SZB58BRW	SZB58WH
3/8 in. x 3/4 in. x 1-7/8 in. - 8 ft.	SZB34GAL-8	-	-	-	-
3/8 in. x 3/4 in. x 1-7/8 in.	SZB34G	SZB34B	-	516859	516959
3/8 in. x 3/4 in. x 2 in.	-	-	-	-	517734*
3/8 in. x 1 in. x 1-5/8 in.	SZB38G-1158	-	-	-	517267
3/8 in. x 1 in. x 2 in.	SZB1G-2	-	-	516623*	517737*
3/8 in. x 1-1/2 in. x 6 in.	-	-	-	517314	-
3/8 in. x 2 in. x 3/4 in.	820099	-	-	-	-
3/8 in. x 2-1/2 in. x 1-1/2 in.	-	516592	-	-	-
2 in. x 1 in. x 2 in.	ZB5G	-	-	-	-
2 in. x 1 in. x 3 in.	ZB6G	ZB6B	-	-	-

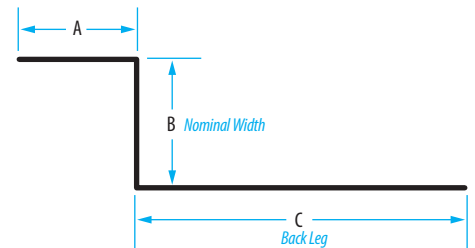

All bends 90° except those marked with * 100° B leg

26 Gauge Z-Flashing 10 ft. lengths · 26 Gauge Galvanized Steel · Pack Quantity: 20

Size: A x B x C	Galvanized	Brown	Charcoal
2 in. x 1 in. x 2 in.	ZB5G-26	-	-
2 in. x 1 in. x 3 in.	ZB6G-26	-	-
2 in. x 1-1/2 in. x 2 in.	ZB55G-26	-	-
3 in. x 1 in. x 3 in.	-	SZB313BR-26	SZB313CH-26

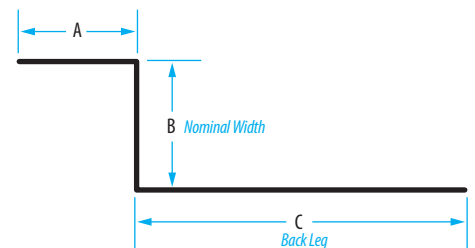

Millwork Z-Flashing 10 ft. lengths · 28 Gauge Galvanized Steel · Pack Quantity: 20

Size: A x B x C	Galvanized	Bonderized	White
3/8 in. x 1-1/8 in. x 2 in.	SZB118G-2	-	SZB118WH-2
3/8 in. x 1-1/4 in. x 2 in.	SZB125G-2	-	-
3/8 in. x 1-1/2 in. x 2 in.	SZB115G-2	-	-
1/4 in. x 1-1/4 in. x 1-3/8 in.*	FLGAWF	-	-
1/2 in. x 1-1/2 in. x 2 in.	WT22G	WT22B	-

*8 ft. lengths

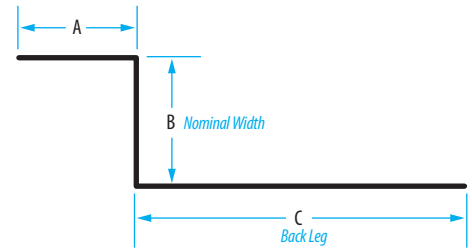

Stainless Steel Z-Flashing 10 ft. lengths · 28 Gauge Galvanized Steel · Pack Quantity: 20

Size: A x B x C	Stainless Steel
3/8 in. x 1 1/2 in. x 2-1/8 in.	SZB12SS
3/8 in. x 5/8 in. x 2 in.	SZB58SS
3/8 in. x 3/4 in. x 1-7/8 in.	SZB34SS
3/8 in. x 1 in. x 2 in.	SZB15S-2
3/8 in. x 1-1/2 in. x 2 in.	SZB115SS-2

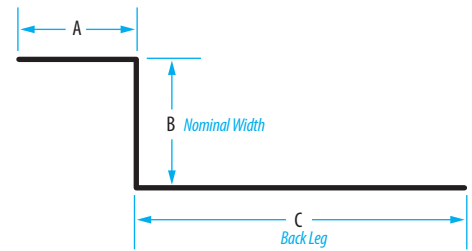

Siding Corners Pack Quantity: 200

Size	Part #
1/2 in. x 6 in. - 26 Ga. Bonderized Steel	513002
1/2 in. x 8 in. - 26 Ga. Bonderized Steel	SC128
3/4 in. x 8 in. - 26 Ga. Bonderized Steel	513010
3/4 in. x 12 in. - 26 Ga. Bonderized Steel	SC3412



Galvanized Steel Roll Flashing

Size	30 Gauge			28 Gauge		26 Gauge
	10 ft.	25 ft.	50 ft.	25 ft.	50 ft.	50 ft.
7 in.	518940	518945	518906	RV725G	-	-
8 in.	-	-	518907	-	-	RV850G-26
10 in.	518941	518946	ERV1050G	RV1025G	-	-
12 in.	-	-	-	RV1225G	-	-
14 in.	518942	518947	518902	RV1425G	RV1450G	RV1450G-26
16 in.	-	-	518917	-	-	-
20 in.	518943	518948	518904	RV2025G	-	RV2050G-26
24 in.	-	-	518919	-	RV2450G	



Painted Steel Roll Flashing Pack Quantity: 1

Size	Dark Brown 30 Gauge			Black/Gray 30 Ga.	Black/D. Brown 26 Ga.
	10 ft.	25 ft.	50 ft.	50 ft.	50 ft.
7 in.	518980	518985	518932	-	-
8 in.	-	-	-	-	-
10 in.	518981	518986	518933	-	-
14 in.	518982	518987	518930	518991	519027
16 in.	-	-	518929	-	-
20 in.	518983	518988	518931	518992	519028
24 in.	-	-	518960	-	-



Aluminum Roll Flashing

Size	10 ft.	25 ft.	50 ft.
6 in.	-	RV625A*	-
7 in.	RV710A	518955	RV750A
8 in.	-	RV825A	-
10 in.	RV1010A	RV1025A	RV1050A
14 in.	RV1410A	RV1425A	RV1450A
20 in.	RV2010A	RV2025A	RV2050A
28 in.	-	-	511942



7" Spool Painted Steel Roll Flashing

7 inch diameter spool • 28 Gauge • Pack Quantity:1

Size	Part #
20 in. x 50 ft. - Black/Gray	RV2050BLGR
20 in. x 50 ft. - Dark Brown	RV2050BRW-7
20 in. x 50 ft. - White	RV2050WH-7

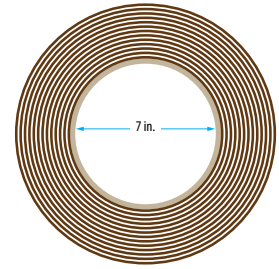

Flat Stock & Step Flashing

Flat Stock

Size	Part #	QTY
3 ft. x 4 ft. 28 Gauge Galvanized Steel	FS34G	25
3 ft. x 4 ft. 28 Gauge Bonderized Steel	FS34B	25



Galvanized Flat Shingles

Size	Part #	QTY
5 in. x 7 in. 30 Ga. Galvanized Steel	511001	100
5 in. x 8 in. 30 Ga. Galvanized Steel	511002	100
8 in. x 12 in. 30 Ga. Galvanized Steel	511011	50
5 in. x 7 in. 28 Ga. Galvanized Steel - 25 pack	S57G-25	10
5 in. x 7 in. 28 Ga. Galvanized Steel - each	S57EA-200	200
5 in. x 8 in. 28 Ga. Galvanized Steel - each	S58EA-200	200
6 in. x 8 in. 28 Ga. Galvanized Steel	S68G-100	100
8 in. x 8 in. 28 Ga. Galvanized Steel - 25 pack	S88G-25	10
8 in. x 12 in. 28 Ga. Galvanized Steel	S812G-50	50
8 in. x 12 in. 28 Ga. Galvanized Steel - each	S812EA-100	100

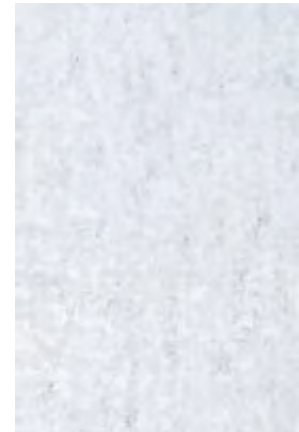

Painted Flat Shingles

Black/Dark Brown • 26 Ga.



26	Part #	Q
5 x 8	511127	100
8 x 8	511129	50
8 x 10	511134	50
8 x 12	511136	50

Black/Gray • 28 & 30 Gauge



30	Part #	Q
5 x 8	511024	100
8 x 8	511069	50
8 x 12	511018	50
8 x 14	511045	50

28	Part #	Q
5 x 8	S58BLGREA-200	200
8 x 12	S812BLGREA-100	100

Dark Brown • 28 & 30 Gauge

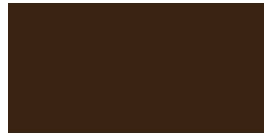

30	Part #	Q
5 x 7	511006	100
5 x 8	511003	100
8 x 8	511019	50
8 x 12	511004	50
8 x 14	511005	50

28	Part #	Q
5 x 8	S58BRWEA-200	200
8 x 12	S812BRWEA-100	100

Brown • 28 Gauge



28	Part #	Q
6 x 8	S68BR-100	100
8 x 12	S812BR-50	50

White • 30 Gauge

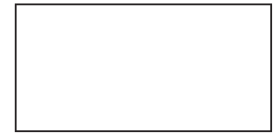

30	Part #	Q
6 x 8	511034	100

Gray • 30 Gauge



30	Part #	Q
8 x 8	511093	100

30 Gauge Galvanized Step Flashing

Description	Part #	QTY
4 in. x 4 in. x 8 in. - 30 Gauge	511015	50
4 in. x 4 in. x 12 in. - 30 Gauge	511013	50
4 in. x 4 in. x 14 in. - 30 Gauge	518004	50

28 Gauge Galvanized Step Flashing

Description	Part #	QTY
3 in. x 3 in. x 7 in. - 28 Gauge - 25 pack	SF337G-25	10
3 in. x 4 in. x 7 in. - 28 Gauge - 50 pack	SF347G-50	50
3 in. x 4 in. x 7 in. - 28 Gauge - each	SF347EA-200	200
3 in. x 5 in. x 7 in. - 26 Gauge	SF357G-26-100	100
3 in. x 5 in. x 8 in. - 28 Gauge. - 25 pack	SF358G-25	10
3 in. x 5 in. x 8 in. - 28 Gauge	SF358G-50	50
4 in. x 4 in. x 8 in. - 28 Gauge - each	SF448EA-50	50
4 in. x 4 in. x 12 in. - 28 Gauge - each	SF4412EA-100	100
4 in. x 6 in. x 14 in. - 28 Gauge - 25 pack	SF4614G-25	25
4 in. x 6 in. x 14 in. - 28 Gauge - each	SF4614EA-50	50



Step Flashing with the word "each" in the description are individually bar coded.

Painted Step Flashing

Black - 26, 28 & 30 Gauge

30 Gauge	Part #	QTY
4 x 4 x 8 in.	SF448BLEA30-50	50
4 x 4 x 12 in.	511037	50
4 x 4 x 14 in.	518044	50

28 Gauge	Part #	QTY
4 x 4 x 8 in.	511040	50
4 x 4 x 12 in. - each	SF4412BLEA-100	100

26 Gauge	Part #	QTY
4 x 4 x 8 in.	511062	50

Dark Brown - 26, 28 & 30 Gauge

28 Gauge	Part #	QTY
4 x 4 x 8 in.	511020	50
4 x 4 x 12 in. - each	SF4412BRWEA-100	100
4 x 6 x 14 in. - 25 pk	SF4614BRW-25	10

30 Gauge	Part #	QTY
4 x 4 x 8 in.	SF448BRWEA30-50	50
4 x 4 x 12 in.	511008	50
4 x 4 x 14 in.	518014	50

26 Gauge	Part #	QTY
4 x 4 x 8 in.	511061	50

Gray - 30 Gauge

30 Gauge	Part #	QTY
4 x 4 x 8 in.	511050	50
4. x 4 x 12 in.	511038	25
4 x 4 x 14 in.	518054	50

Brown - 28 Gauge

30 Gauge	Part #	QTY
3 x 5 x 8 in.	SF358BR-50	50

White - 30 Gauge

30 Gauge	Part #	QTY
4 x 4 x 8 in.	511060	50
4. x 4 x 12 in.	511036	50
4 x 4 x 14 in.	518034	50

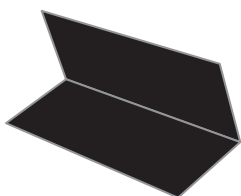

Black

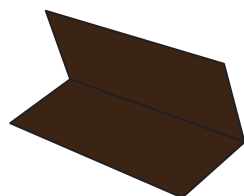

Dark Brown

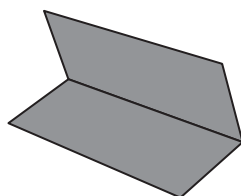

Gray

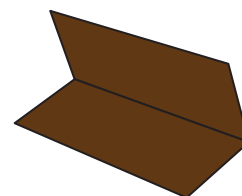

Brown

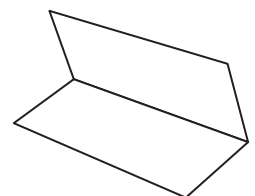

White

Rubber Sleeve

Adjustable Pipe Flashing - QTY: 20

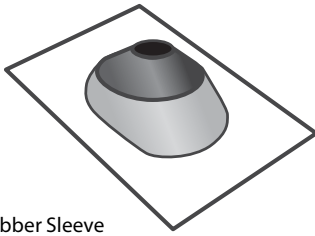

Rubber Sleeve

Size	Part #
Combo Flashing - 1-1/4 - 1-1/2 in.	CMIGB1
Combo Flashing - 2 in.	CMIGB2
Combo Flashing - 3 in.	CMIGB3
Combo Flashing - 4 in.	CMIGB4

Hard Plastic Base

Adjustable Pipe Flashing - QTY: 20

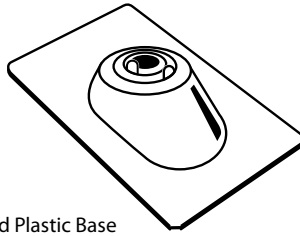

Hard Plastic Base

Size	Part #
Hard Plastic Base - 1 - 3 in.	CMIHB31
Hard Plastic Base - 3 - 4 in.	CMIHB34

Galvanized Base

Adjustable Pipe Flashing - QTY: 20

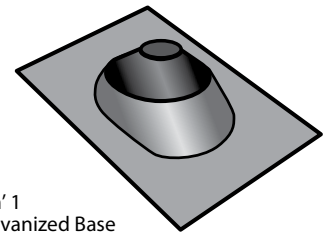

3 'n' 1 Galvanized Base

Size	Galv.	Black	Brown	Gray
1-1/4-3 in.	3-1RJ	559159	559158	559161
3-4 in.	3-4RJ	559166	559165	559167

Aluminum FHA Pipe Flashing



Size	Part #	QTY
3/4 in.	3FL.75A	25
1 in.	3FL1A	25
1-1/2 in.	3FL1.5A	25
2 in.	3FL2A	25
3 in.	3FL3A	25
4 in.	3FL4A	25
5 in.	3FL5A	25
6 in.	3FL6A	10
7 in.	3FL7A	10
8 in.	3FL8A	10

Galvanized FHA Pipe Flashing

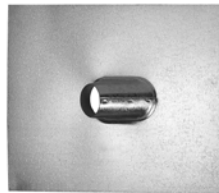

Size	Oval	QTY
1-1/2 in.	RJ15FHA-SP	25
2 in.	RJ2FHA-SP	25
3 in. Soil	RJ3FHA-SL	10
4 in.	RJ4FHA-SL	10

Size	Round	QTY
1-1/2 in.	RJ15FHA-SP-NL	10
2 in.	RJ2FHA-SP-NL	10
3 in. Soil	RJ3FHA-SL-NL	10
4 in.	RJ4FHA-SL-NL	10

Size	Regular Base	QTY
3 - 4 in.	RJ34STD	25
5 - 6 in.	RJ56STD	25
7 - 8 in.	RJ78STD	25

Size	Shake Base	QTY
3 - 4 in.	RJ34SH	25
5 - 6 in.	RJ56SH	25
7 - 8 in.	RJ78SH	25
10 in.	RJ10SH	10
12 in.	RJ12SH	10

Zinc Pipe Flashing - 26 Gauge



Size	Standard Base	QTY
1/2 in.	3STF.5Z26	25
3/4 in.	3STF.75Z26	25
1 in.	3STF1Z26	25
1 1/2 in.	3STF1.5Z26	25
2 in.	3STF2Z26	25
3 in.	3STF3Z26	25
3 in. Soil	3STF3Z26S	25
4 in.	3STF4Z26S	25
5 in.	3STF5Z26	10
6 in.	3STF6Z26	10

Size	FHA Base	QTY
1/2 in.	3FF.5Z26	25
3/4 in.	3FF.75Z26	25
1-1/2 in.	3FF1.5Z26	25
2 in.	3FF2Z26	25
3 in. Soil	3FF3Z26S	25
4 in.	3FF4Z26	25
4 in. Oval	3FF4Z26O	25
5 in.	3FF5Z26	10
6 in.	3FF6Z26	10
7 in.	3FF7Z26	10
8 in.	3FF8Z26	10
10 in.	3FF10Z26	10

Plumber's Flashing - Round Cone

Size	26 Gauge Galvanized		26 Gauge Zinc		QTY
	Regular Base	Shake Base	Regular Base	RDS	
1/2 in.	3PF.5G26R	-	3PF.5Z26R	-	25
3/4 in.	3PF.75G26R	-	-	-	25
1 in.	3PF1G26R	-	-	-	25
1-1/2 in.	3PF1.5G26R	3PF1.5G26S	3PF1.5Z26R	3PF1.5Z26RDS	25
2 in.	3PF2G26R	3PF2G26S	-	3PF2Z26RDS	25
3 in.	3PF3G26R	3PF3G26S	-	-	25
4 in.	3PF4G26R	3PF4G26S	-	3PF4Z26RDS	25
8 in.	3PF8G26	-	-	-	10

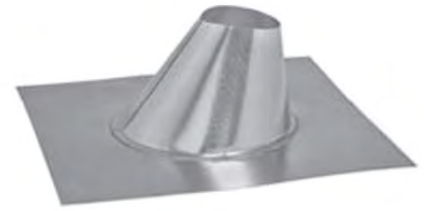

Scupper - Left

26 Gauge Galvanized · Pack Quantity: 5 pcs

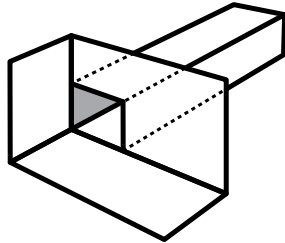

Size: A x B	Part #
2 in. x 3 in. + 10 in. tube	3SPL23G26
3 in. x 4 in. + 10 in. tube	3SPL34G26
4 in. x 6 in. + 10 in. tube	3SPL46G26

Scupper - Center

26 Gauge Galvanized · Pack Quantity: 10 pcs

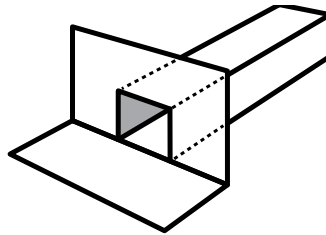

Size: A x B	Part #
2 in. x 3 in. + 10 in. tube	3SPC23G26
3 in. x 4 in. + 10 in. tube	3SPC34G26
4 in. x 4 in. + 10 in. tube	3SPC4G26
4 in. x 6 in. + 10 in. tube	3SPC46G26

Scupper - Right

26 Gauge Galvanized · Pack Quantity: 5 pcs

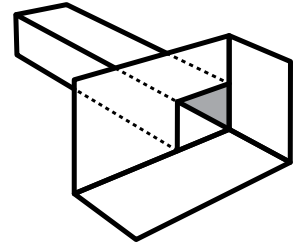

Size: A x B	Part #
2 in. x 3 in. + 10 in. tube	3SPR23G26
3 in. x 4 in. + 10 in. tube	3SPR34G26
4 in. x 6 in. + 10 in. tube	3SPR46G26

Roof Outlet

28 Ga. Galvanized Steel

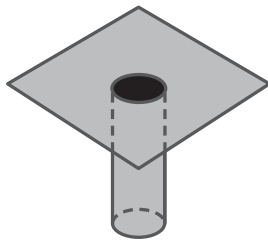

Description	Part #	QTY
2 in. Diameter x 5 in.	2RO25G	25
2 in. Diameter x 10 in.	3RO210G	25
3 in. Diameter x 10 in.	243018	12

Flue Guard™ Spark Arrestor Chimney Cap

- Sloped lid • 20 gauge powder coated steel
- No tools required • 5/8 in. mesh
- Universal fit: 6 in. x 9 in. up to 14 in. X 22 in.

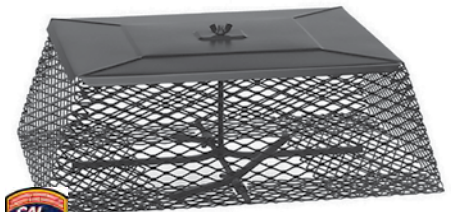

Genuine 5/8" mesh meets the strict California Fire Code!

Description	Part #	QTY
Flue Guard™ Chimney Cap	CG3BLK	4



Rectangular Gable Louver: Flange Center 1/8 inch galvanized insect screen · Pack Quantity: 10

Size: A x B	N.F.V.	Galvanized	Brown	White
12 in. x 12 in.	50.5 sq. in.	GLFC1212G-1/8	GLFC1212BR-1/8	GLFC1212WH-1/8
12 in. x 18 in.	79.0 sq. in.	GLFC1218G-1/8	GLFC1218BR-1/8	GLFC1218WH-1/8
14 in. x 12 in.	56.2 sq. in.	-	-	GLFC1412WH-1/8
14 in. x 18 in.	93.4 sq. in.	-	GLFC1418BR-1/8	GLFC1418WH-1/8
14 in. x 24 in.	131.6 sq. in.	GLFC1424G-1/8	GLFC1424BR-1/8	GLFC1424WH-1/8

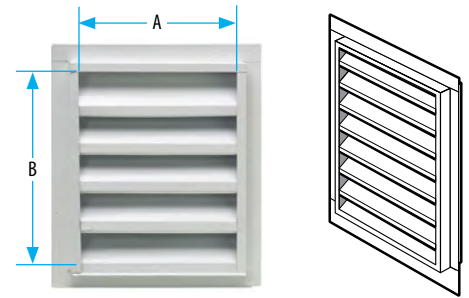

Rectangular Gable Louver: Flange Front 1/8 inch galvanized insect screen

Size: A x B	N.F.V.	Galvanized	White	QTY
12 in. x 12 in.	50.5 sq. in.	GLFF1212G-1/8	GLFF1212WH-1/8	10
12 in. x 18 in.	79.0 sq. in.	GLFF1218G-1/8	GLFF1218WH-1/8	10
14 in. x 12 in.	56.2 sq. in.	GLFF1412G-1/8	GLFF1412WH-1/8	10
14 in. x 18 in.	93.4 sq. in.	GLFF1418G-1/8	GLFF1418WH-1/8	10
14 in. x 24 in.	131.6 sq. in.	GLFF1424G-1/8	GLFF1424WH-1/8	10
18 in. x 24 in.	165.7 sq. in.	GLFF1824G-1/8	-	5
24 in. x 24 in.	221.5 sq. in.	GLFF2424G-1/8	-	5

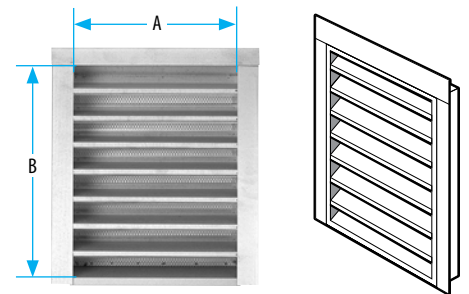

Rectangular Gable Louver: Plaster Ground 1/8 inch galvanized insect screen

Size: A x B	N.F.V.	Galvanized	QTY
12 in. x 12 in.	50.5 sq. in.	GLPG1212G-1/8	10
12 in. x 18 in.	79.0 sq. in.	GLPG1218G-1/8	10
14 in. x 12 in.	56.2 sq. in.	GLPG1412G-1/8	10
14 in. x 18 in.	93.4 sq. in.	GLPG1418G-1/8	10
14 in. x 24 in.	131.6 sq. in.	GLPG1424G-1/8	10
18 in. x 24 in.	170.8 sq. in.	GLPG1824G-1/8	5
24 in. x 24 in.	221.5 sq. in.	GLPG2424G-1/8	5

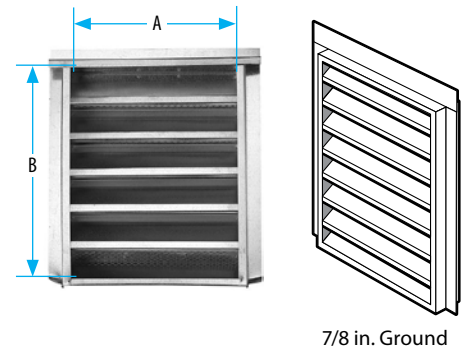

Bonderized Gable Louver 1/8 inch galvanized insect screen

Size: A x B	N.F.V.	Part #	QTY
14 in. x 18 in. Flange Front	93.4 sq. in.	GLFF1418B-1/8	10
14 in. x 18 in. Plaster Ground	93.4 sq. in.	GLPG1418B-1/8	10
14 in. x 24 in. Plaster Ground	131.6 sq. in.	GLPG1424B-1/8	10

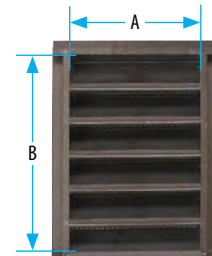

Norwesco® Reversible Vent 30 Ga. Galvanized Steel · Louvered Screen · Reversible design for more flexible installation.

Size: A x B	N.F.V.	Galv.	Dk. Brown	White	QTY
8 in. x 12 in.	24 sq. in.	553200	-	-	6
12 in. x 12 in.	62 sq. in.	553220	553520	-	6
12 in. x 18 in.	100 sq. in.	553230	553530	553830	6
14 in. x 24 in.	162 sq. in.	553250	553550	553850	6
24 in. x 30 in.	358 sq. in.	553270	-	-	2

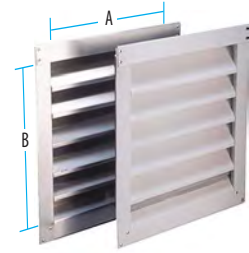

Econo Vent 26 Gauge Galvanized Steel · Flat roof.

Size	N.F.V.	Part#	QTY
12 x 12 in.	160 sq. in.	1212EV	2
18 x 18 in.	240 sq. in.	1818EV	2

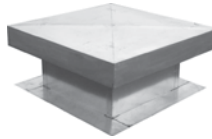

J-Vent 26 Gauge Galvanized Steel · Pack Quantity: 6

Size	N.F.V.	Part #	Flange
3 inch	7 sq. in.	JV328	3 in. x 8 in.
4 inch	12 sq. in.	JV428	4 in. x 9 in.
8 inch	50 sq. in.	JV826	8 in. x 15 in.

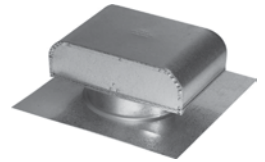

T-Top 26 Gauge

Description	Aluminum	Galvanized	Bonderized	Zinc	QTY
4 in. Standard Base	-	RJ4G	RJ4B	-	12
4 in. FHA Base - Hemmed	3TT4A	-	-	-	105
4 in. FHA Base - Unhemmed	-	3TT4G26	-	3TT4Z26	105
7 in. Standard Base	-	RJ7G	RJ7B	-	8
7 in. FHA Base - Unhemmed	3TT7A	-	-	3TT7Z26	50
7 in. Shake Base - Unhemmed	-	3TT7G26-HEM	-	3TT7Z26SEC	50



Total JACK™ The only roof jack with an adjustable stack and base. Adjusts to fit most roof pitches.

Size	Mill	Black	Brown	Weathered Wood	QTY
6 in.	JACK6GZ	JACK6BLK	JACK6BRN	JACK6WWD	7
8 in.	JACK8GZ	JACK8BLK	JACK8BRN	JACK8WWD	6

Galvanized steel in accordance to ASTM A924/A653
Base Material: Galvanized 0.016 in. / Painted 0.019 in.
Stack Material: Galvanized 0.012 in. / Painted .013 in.
Cap Material: Galvanized 0.012 in. / Painted 0.013 in.



T-Top Sub-Base

Size	Part #	QTY
4 in. Sub Base - 28 Ga.	SJ4G	20
5-6 in. Sub Base - 26 Ga.	3SBF56G26	20
7 in. Sub Base - 28 Ga.	SJ7G	20

Vent Adapter For 6 in. circular roof vent

4 inch	6 inch	7 inch	QTY
559174	559176	559177	6



Vent Caps

Size	Round	Oval	QTY
3 inch	RBVC3	-	24
4 inch	RBVC4	OBVC4	24
5 inch	RBVC5	-	12
6 inch	RBVC6	-	6



Oval



Round



Code Caps & Bases Pack Quantity: 6

Size	Regular Base
3 inch	3CD3BaseR
4 inch	3CD4BaseR
5 inch	3CD5BaseR
6 inch	3CD6BaseR
8 inch	3CD8BaseR

Size	Shake Base
3 inch	3CD3BaseS
4 inch	3CD4BaseS
5 inch	3CD5BaseS
6 inch	3CD6BaseS
8 inch	3CD8BaseS

Size	Top Only
3 inch	3CD3TOP
4 inch	3CD4TOP
4 inch Oval	3CD4TOPO
5 inch	3CD5TOP
6 inch	3CD6TOP
8 inch	3CD8TOP

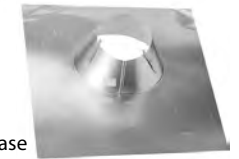

Base

Half Round Dormer

Federal Spec. QQ-5775A, Type 1, Class 4 ASTM A-527 · Pack Quantity: 6

Size	N.F.V.	Part #
18 in. x 9 in. Galvanized	75 sq. in.	STDH18GB
24 in. x 12 in. Galvanized	100 sq. in.	BH24

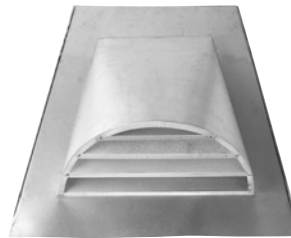

Dormer Sub-Base

Pack Quantity: 20

Description	Part#
18" - 10 x 10 - Screen	3SBF1010S
18" - 10 x 10	STD18SJ
24" - 14 x 14 - Screen	3SBF1414S
24" - 14 x 14	STD24SJ

Low Profile Dormer

Galvanized Steel · Hard Flange · 1/4 in. galvanized mesh

Size	N.F.V.	Part #	QTY.
18 in. x 7 in.	81 sq. in.	LPDH18	6
19 in. x 4 in.	43 sq. in.	LPDG19	10

Soft Flange Dormer

1/8 in. galvanized mesh. Pack Quantity: 6
Galvanized Steel + Soft Aluminum Flange for curved tile roofs

Size	N.F.V.	Part #
24 x 12 - Aluminum 2 sides	91.9 sq. in.	STDS24-2B
24 x 12 - Aluminum 3 sides	91.9 sq. in.	STDS24-3B

Kwik Mesh™

Galvanized - 1/8 in. mesh

Size	Part #	QTY.
4 in. x 25 ft.	KM425	6 rolls
6 in. x 25 ft.	KM625	6 rolls
8 in. x 25 ft.	KM825	3 rolls
12 in. x 20 ft.	KM1220	3 rolls

KM425 34.08 sq. in./ft. N.F.A.
KM625 51.12 sq. in./ft. N.F.A.
KM825 68.16 sq. in./ft. N.F.A.
KM1220 102.24 sq. in./ft. N.F.A.



Aluminum Mesh

Aluminum - 1/8 in. mesh

Size	Part #	QTY.
4 in. x 100 ft.	969181	6 rolls
6 in. x 100 ft.	969182	4 rolls
8 in. x 100 ft.	969183	3 rolls
12 in. x 100 ft.	969186	2 rolls

Metal Stem Vent Pack Quantity: 2

Size	Galv. - Stem Only	Black	Dark Brown	Gray
4 inch	556071	556060	556061	556074
6 inch	556072	556064	556065	-
8 inch	-	556070	556069	-



Plastic Stem Vent Pack Quantity: 4

Size	Black	Dark Brown	Gray	White
4 inch	559427	559428	559425	559429
5 inch	559433	559434	-	-
6 inch	559439	559440	559437	-

4 inch Plastic Roof Cap - No Stem - Black	559415	6
4 inch Plastic Roof Cap - No Stem - Dark Brown	559416	6



24 in. Stealth Vent 72 sq. in. N.F.V. · 26 Gauge Galvanized Steel · ICC ER-5463 · Dade County 80 mph wind driven rain test

Description	No Hem	Hemmed	QTY
Zinc	3STH24Z26ANH	3STH24Z26A	50
Black	3STH24BL26ANH	3STH24BL26A	50
Brown	3STH24BR26ANH	3STH24BR26A	50
Charcoal	3STH24CH26ANH	3STH24CH26A	50
Sub-Base with Screen	3SBF24Z26STHS	-	10



Roof Deck Opening: 14 in. x 5 in. Hemmed Vent for Tile Roofs; requires Sub-Base. Sub Base not required for unhemmed composition shingle application.

Black Mesh, 36, & 48 inch Stealth Vents available upon request, order minimum 100. Contact your Gibraltar Rep for further details.

50 Square Inch Plastic Vent Pack Quantity: 12

	Black	Brown	D. Brown	Gray	Translucent	Wth'd Gray	White
PRV-50	559012	559010	559011	559013	-	559015	-
AF-50	559453	559450	559454	559451	559449	559452	559455



PRV-50



AF-50

92 Square Inch Plastic Vent



* Translucent Vent has a Gray Base

Black	Brown	Dk. Brown	Gray	Translucent	Weathered Gray	QTY
559471	559468	559472	559469	559445*	559470	8

61 Square Inch Plastic Vent



Color	Part #	QTY
Black	90121	10

38 Square Inch Steel Vent Slant Back · Galvanized Steel · 17 in. x 20 in. flange

Galvanized	Black	Dark Brown	Gray	White	QTY
558011	557167	556157	557157	556167	6



38 Square Inch Steel Vent Square Top · Galvanized Steel · 17 in. x 17 in. flange

	Galvanized	Black	Dark Brown	Gray	White	QTY
Standard	556042	557059	556159	557159	556150	6
Torch Down	-	557168	556186	557171	557164	4



40 Square Inch Steel Vent Slant Back · Galvanized Steel

Black	Brown	QTY
RVG40010	RVG40080	9



49 Square Inch Steel Vent Slant Back · 18 in. x 22 in. flange

Galvanized	Black	Dk. Brown	Gray	White	QTY
558012	557153	556154	557154	557145	6



49 Square Inch Steel Vent Square Top · 18 in. x 18 in. flange

Black	Dark Brown	Gray	QTY
557160	556158	557158	6



50 Square Inch Steel Vent

Description	Galvanized	Black	Brown	QTY
Square Top	RVG51000	RVG51010	RVG51080	9
Slant Back	-	RVG55016	RVG55086	6
50 Square Inch Aluminum Vent - Mill Finish			RVA510000	12



Ventilating Access Door

1/8 inch mesh · For crawl space access

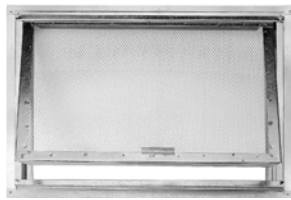

18 in. x 24 in. | R.O.: 18.25 in. x 25 in.

Description	Part #	QTY
Ventilating Access Door	CHADS	10

Tube Access Door

Piano hinge · Pressure fit door · Drywall Frame



14 in. x 14 in.

Description	Part #	QTY
Tube Access Door	TA14DW	10

4 Inch Dryer Cap

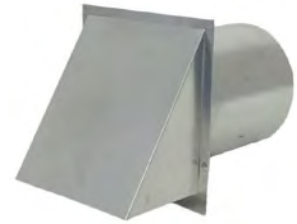

Description	Part #	QTY
Galvanized Steel	DV4	14

Aluminum Louvered Vents

For soffit and eave venting

Size: A x B	N.F.V.	R. Opening	Mill	Brown	White	QTY.
16 in. x 4 in.	28 sq. in.	15 in. x 3 in.	84126	84228	84226	24
16 in. x 6 in.	42 sq. in.	15 in. x 5 in.	84115	84217	84215	24
16 in. x 8 in.	56 sq. in.	15 in. x 7 in.	84210	84212	84211	24



Flat Screen Vent

Galvanized Steel · 1/8 in. mesh

Size: A x B	N.F.V.	Rough Opening	Part #	QTY.
16 in. x 4 in.	23.7 sq. in.	14.5 in. x 2.5 in.	SCV164	25
16 in. x 6 in.	42.6 sq. in.	14.5 in. x 4.5 in.	SCV166	25
16 in. x 8 in.	61.5 sq. in.	14.5 in. x 6.5 in.	SCV168	25



Two Way Vents

Galvanized steel · 1/8 in. mesh · Reversible flange for plaster or surface mount

Size: A x B	N.F.V.	Rough Opening	Part #	QTY.
14 in. x 4 in.	28.4 sq. in.	13.75 in. x 3.25 in.	TW144	30
14 in. x 6 in.	44.8 sq. in.	13.75 in. x 5.25 in.	TW146	24
14 in. x 8 in.	62.2 sq. in.	13.75 in. x 7.25 in.	TW148	16

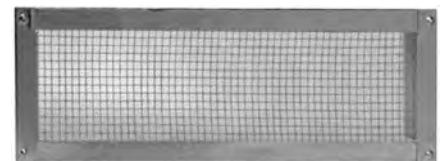

Two Way Vent

With decorative floral plastic insert

Description	Part #	QTY.
14 in. x 6 in. Vent + Insert	TWPIV	24
Insert only	PIV614	24



Mini Louver

Aluminum, with Screen

Size	N.F.V.	Part #	QTY.
1-1/2 inch	0.39 sq. in.	ML1.5	12
2 inch	0.45 sq. in.	559111	36
2-1/2 inch	1.2 sq. in.	559112	36
3 inch	1.7 sq. in.	559001	36
4 inch	3.5 sq. in.	559002	36



Mini Louver

Aluminum, no Screen

Size	N.F.V.	Part #	QTY.
2 inch	0.47 sq. in.	ML2	100
3 inch	1.34 sq. in.	ML3	50
4 inch	2.88 sq. in.	ML4	20

Continuous Soffit Vent

Description	N.F.V.	Mill	Black	Brown	White	QTY.
Aluminum	10 sq. in./ft.	556004	556014	556018	556019	30
Plastic	6.625 sq. in./ft.	n/a	-	559006	559007	75



Soffit Vent Stucco Ready · 1/8 inch mesh

Size: A x B	N.F.V.	Rough Opening	Part #	QTY.
14 in. x 5 in.	52.1 sq. in.	14.5 in. x 5.5 in.	SV145-1/8	26
22 in. x 3 in.	51.4 sq. in.	22.5 in. x 3.25 in.	SV223-1/8	9



Flush Mount Soffit Vent 1/8 inch Mesh · Pack Quantity: 12

Description	N.F.V.	Galvanized	Brown	White	QTY.
16 in. x 4 in.	Contact Sales	556005	556146	556446	12
16 in. x 6 in.	Contact Sales	558006	556147	556447	12
16 in. x 8 in.	Contact Sales	558007	556148	556448	12



Flush Mount Soffit Vent With Damper · 1/8 inch Mesh · Pack Quantity: 12

Description	N.F.V.	Galvanized	Brown	White	QTY.
16 in. x 4 in.	Contact Sales	558025	556161	556461	12
16 in. x 6 in.	Contact Sales	558026	556162	556462	12
16 in. x 8 in.	Contact Sales	558027	556163	556463	12



with manual damper

Eave Vent Stucco or Straight Flange · 1/8 inch mesh

Size	N.F.V.	Galvanized	Bonderized	Brown	QTY.
22 in. x 3 in. - 1/8 mesh - STU	34.3 sq. in.	EV223	-	-	25
22 in. x 3 in. - 1/8 mesh - REG	34.3 sq. in.	-	556017	556015	50
22 in. x 3 in. w/Louvers - REG	34.3 sq. in.	-	556007	-	50
22 in. x 5 in. - 1/8 mesh - REG	Contact Sales	-	556177	-	50
22 in. x 6 in. - 1/8 mesh - REG	61.7 sq. in.	EV622	-	-	25
14 in. x 5 in. - 1/8 mesh - STU	38.2 sq. in.	EV145	-	-	25
14 in. x 6 in. - 1/8 mesh - REG	38.2 sq. in.	EV614	-	-	25



STU = Stucco Flange
REG = Straight Flange

Adjustable Foundation Vent

Aluminum, with sliding damper



Description	N.F.V.	Part#	QTY.
16 in. x 8 in.	102 sq. in.	FA109000	12

Stamped Foundation Vent Stucco Reveal



Galvanized

Description	N.F.V.	Part #	QTY.
14 x 6 in. - 1/8 mesh	51	FV146G	25
16 x 8 in. - 1/8 mesh	75	558037	30

Bonderized

14 x 6 in. - 1/4 mesh	51	FV146B	25
-----------------------	----	--------	----

Rim Vent Pack Quantity: 24



Rugged UV resistant plastic

Description	N.F.V.	Part #
16 in. x 8 in. - White	62 sq. in.	559408

Damper Doors - Foundation Vent Clips

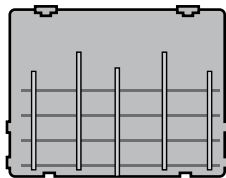

Description	Part#	QTY.
Vent-Aire Door	559217	80
Norwesco - PFV6-8	596140	72

Foam Plugs Sold in Pairs



DVBPSM-EA

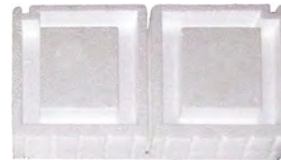

DVBP



DVBPXL

Description	Part#	QTY.
Lawrence - 5.5 in. x 7.5 in.	DVBPSM-EA	45
Vent-Aire - 6.5 in. x 7.75 in.	DVBP	40
Norwesco - 6.5 in. x 8.75 in.	DVBPXL	36

Pour-In-Place Foundation Vent

Description	N.F.V.	Color	Part#	QTY.
PFV-6-8 Combo	100 sq. in.	Gray	596037	12
PFV-6-8 Combo - with damper door	100 sq. in.	Gray	596137	12
6 in.- with damper door	72.5 sq. in.	Gray	DVB6	20
6 in. - no door	72.5 sq. in.	Gray	559021	20
6 in. - with damper door	72.5 sq. in.	Gray	559023	20
6 in. - no door	72.5 sq. in.	Black	559020	20
6 in. - with damper door	72.5 sq. in.	Black	559022	20
8 in. - no door	72.5 sq. in.	Gray	559027	15
8 in. - with damper door	72.5 sq. in.	Gray	DVB8	15
8 in. - no door	72.5 sq. in.	Black	559026	15
8 in. - with damper door	72.5 sq. in.	Black	559028	15
10 in. - with damper door	72.5 sq. in.	Gray	559035	12



Galvanized Vent Wells

Description - A x B x C	Part#	QTY.
Rectangular - 20 in. x 4 in. x 12	FVW204-12	10
Rectangular - 20 in. x 4 in. x 12 - 20 Gauge	553031	5
Rectangular - 20 in. x 8 in. x 12 - 20 Gauge	553022	5
Rectangular - 20 in. x 12 in. x 12 - 20 Gauge	553001	6
Arched - 20 in. x 8 in. x 12	FVW208-12	10

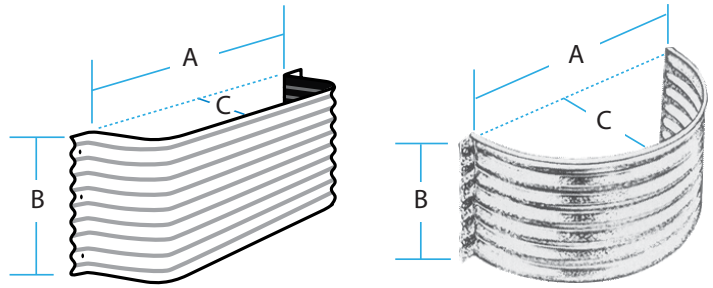

Plastic Vent Wells

Description - A x B x C	Part#	QTY
Dark Brown - 19 in. x 4 in. x 12	569040	10
Gray - 19 in. x 4 in. x 12	569041	10
Gray - 19 in. x 8 in. x 12	569081	6

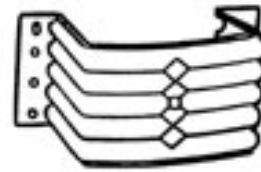

Drywall Clips

6 per Pack · 20 Packs per Carton

1/2 inch	5/8 inch
DRK	DRK58
-	-



Drywall Squares 16 in. x 16 in.

18 sheets per carton · Pack Quantity: 12 cartons

1/2 inch	5/8 in.
R116-216	R516-816
G116-216*	-

*Greenboard



Rain Diverter

Description	Part #	QTY
28 Ga. Galvanized - 1 1/2 in. x 4 in. x 1/2 in. - 6 ft. Length	RD672G	20
26 Ga. Zinc - 2 in. x 8 1/2 in. x 1/2 in. - 10 ft. Length	RD2855-Z	20

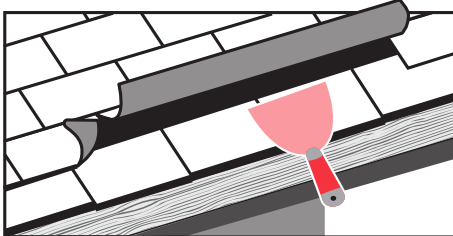
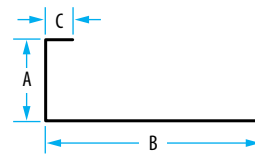

Gently lift 2nd row of shingles, directly above the doorway.

Rain Diverter can also be used to evenly disperse 2nd story downspout runoff to a pitched 1st story roof.

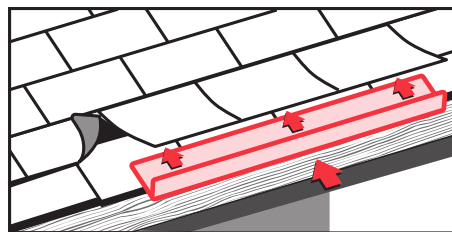

Slide Rain Diverter under shingles as far as it will go, giving it a slight pitch to one side.

Your Rain Diverter should extend at least 1 ft. on either side of the doorway. Cut to desired length with tin snips. For lengths greater than 60 in., overlay 2 or more Rain Diverters.

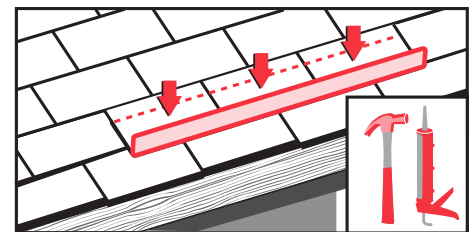

Fasten with 3 hot dipped galvanized roofing nails.

Seal nail heads with roofing cement and press shingles back into place.

Drywall items only sold out of Fife, WA · 800-426-0940

90° Tape-On Odd Leg Outside Corner

8 ft. Carton	10 ft. Carton	MLF	Pieces/Carton	Cartons/Pallet
A1W-8	A1W-10	83.5 lbs.	50	60

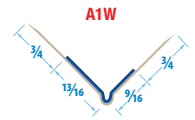
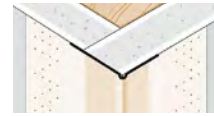

90° Tape-On Extra Wide Odd Leg Outside Corner

8 ft.	9 ft.	10 ft.	12 ft.	MLF	Pcs/Ctn	Ctns/Pal
A1XW-8	A1XW-9	A1XW-10	A1XW-12	95 lbs.	50	60

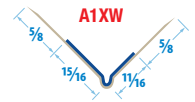
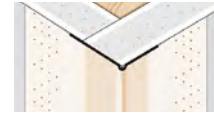

90° Tape-On Extra Wide Even Leg Outside Corner

8 ft.	9 ft.	10 ft.	12 ft.	MLF	Pcs/Ctn	Ctns/Pal
A1XWEL-8	A1XWEL-9	A1XWEL-10	A1XWEL-12	95 lbs.	50	60



90° Tape-On Extra Wide Even Leg Outside Corner - Sunline™

7 ft.	8 ft.	9 ft.	10 ft.	12 ft.	MLF	Pcs/Ctn	Ctns/Pal
S1XW-7	S1XW-8	S1XW-9	S1XW-10	S1XW-12	103.34 lbs.	50	54

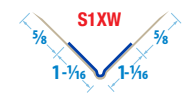

90° Tape-On Extra Extra Wide Even Leg Outside Corner - Sunline™

8 ft.	9 ft.	10 ft.	12 ft.	MLF	Pcs/Ctn	Ctns/Pal
S1XXW-8	S1XXW-9	S1XXW-10	S1XXW-12	121.7 lbs.	50	54



Taper's Bead™ 90° Tape-On Even Leg Outside Corner

7 ft.	8 ft.	9 ft.	10 ft.	12 ft.	MLF	Pcs/Ctn	Ctns/Pal
T1WEL-7	T1WEL-8	T1WEL-9	T1WEL-10	T1WEL-12	83.5 lbs.	50	60



🇨🇦 Only available in Canada.

Taper's Bead™ 90° Tape-On Extra Wide Even Leg Outside Corner

7 ft.	8 ft.	9 ft.	10 ft.	12 ft.	MLF	Pcs/Ctn	Ctns/Pal
T1XWEL-7	T1XWEL-8	T1XWEL-9	T1XWEL-10	T1XWEL-12	95.5 lbs.	50	60



🇨🇦 Only available in Canada.

Taper's Choice™ 90° Tape-On Extra Wide Outside Corner

6 ft.	7 ft.	8 ft.	9 ft.	10 ft.	12 ft.	MLF	Ctn	Pal
TC1XW-6	TC1XW-7	TC1XW-8	TC1XW-9	TC1XW-10	TC1XW-12	103.34 lbs.	50	54



🇨🇦 Only available in Canada.

Taper's Choice™ 90° Tape-On Extra Extra Wide Outside Corner

7 ft.	8 ft.	9 ft.	10 ft.	12 ft.	MLF	Pcs/Ctn	Ctns/Pal
TC1XXW-7	TC1XXW-8	TC1XXW-9	TC1XXW-10	TC1XXW-12	119.75 lbs.	50	54



🇨🇦 Only available in Canada.

135° Tape-On Open Angle Outside Corner

8 ft. Carton	9 ft. Carton	10 ft. Carton	MLF	Pcs/Ctn	Ctns/Pal
A10A-8	A10A-9	A10A-10	73.5 lbs.	50	60

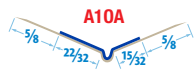

90° Tape-On Inside Corner

8 ft.	10 ft.	2.7 Meter	3.0 Meter	MLF	Pcs/Ctn	Ctns/Pal
A2-8	A2-9	A2-2.7	A2-3.0	48.5 lbs.	50	60

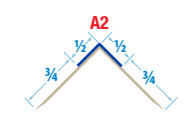

135° Tape-On Open Angle Inside Corner

8 ft. Carton	9 ft. Carton	10 ft. Carton	MLF	Pcs/Ctn	Ctns/Pal
A20A-8	A20A-9	A20A-10	73.5 lbs.	50	60

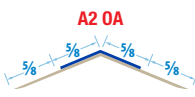

90° Tape-On L-Trim Outside Corner



Tape-On L-Trim is used as a trim piece for wallboard that abuts to suspended ceilings, plaster beams, masonry and concrete surfaces, as well as untrimmed window and door jambs.

50 Pieces per Carton
60 Cartons per Pallet

<p>1/4 inch</p> <p>10 ft. Ctn..... A4-1/4-10 LBS/MLF..... 73.5</p>	<p>3/8 inch</p> <p>10 ft. Ctn..... A4-3/8-10 LBS/MLF..... 73.5</p>	<p>1/2 inch</p> <p>7 ft. Ctn..... A4-1/2-7 8 ft. Ctn..... A4-1/2-8 10 ft. Ctn..... A4-1/2-10 LBS/MLF..... 83.5</p>	<p>1/2 inch No Bead</p> <p>8 ft. Ctn..... A4-1/2NB-8 10 ft. Ctn..... A4-1/2NB-10 12 ft. Ctn..... A4-1/2NB-12 LBS/MLF..... 83.5</p>
<p>5/8 inch</p> <p>8 ft. Ctn..... A4-5/8-8 10 ft. Ctn..... A4-5/8-10 LBS/MLF..... 83.5</p>	<p>5/8 inch No Bead</p> <p>8 ft. Ctn..... A4-5/8NB-8 10 ft. Ctn..... A4-5/8NB-10 LBS/MLF..... 83.5</p>	<p>3/4 inch</p> <p>8 ft. Ctn..... A4-3/4-8 10 ft. Ctn..... A4-3/4-10 LBS/MLF..... 95.0</p>	<p>3/4 inch No Bead</p> <p>10 ft. Ctn..... A4-3/4NB-10 LBS/MLF..... 95.0</p>
<p>1 inch</p> <p>8 ft. Ctn..... A4-1-8 10 ft. Ctn..... A4-1-10 LBS/MLF..... 109.0</p>	<p>1 inch No Bead</p> <p>10 ft. Ctn..... A4-1NB-10 LBS/MLF..... 109.0</p>	<p>1-1/4 inch</p> <p>8 ft. Ctn..... A4-1-1/4-8 10 ft. Ctn..... A4-1-1/4-10 LBS/MLF..... 120.75</p>	<p>1-1/4 inch No Bead</p> <p>10 ft. Ctn..... A4-1-1/4NB-10 LBS/MLF..... 109.0</p>

Drywall items only sold out of Fife, WA · 800-426-0940

Tape-On Z Shadow Trim

10 ft. Carton	MLF	Pieces/Carton	Cartons/Pallet
AST-1/2-10	109 lbs	50	60
AST-5/8-10	121 lbs	50	60

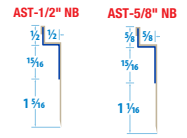

Tape-On Reveal Trim

10 ft. Carton	MLF	Pieces/Carton	Cartons/Pallet
ART-1/2-10	109 lbs	50	60
ART-5/8-10	121 lbs	50	60

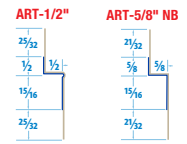

1/2 inch Tape-On J-Trim

7 ft. Carton	8 ft. Carton	9 ft. Carton	MLF	Pieces/Carton	Cartons/Pallet
A9-1/2-7	A9-1/2-8	A9-1/2-9	95 lbs	25	54

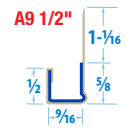

5/8 inch Tape-On J-Trim

7 ft. Carton	8 ft. Carton	9 ft. Carton	MLF	Pieces/Carton	Cartons/Pallet
A9-5/8-7	A9-5/8-8	A9-5/8-9	95 lbs	25	54

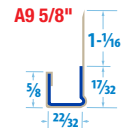

1/2 inch Radius Mini Bull™ Tape-On Outside Corner - Sunline™

MLF: 84 lbs. · Pieces per carton: 50 · Cartons per pallet: 54

7 ft.	8 ft.	8 ft. 6 in.	9 ft.	10 ft.	10 ft. 6 in.	12 ft.
SMB-7	SMB-8	SMB-8.6	SMB-9	SMB-10	SMB-10.6	SMB-12

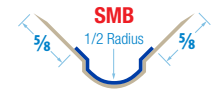

3/4 inch Radius Bullnose Tape-On Outside Corner - Sunline™

MLF: 84.18 lbs. · Pieces per carton: 50 · Cartons per pallet: 60

7 ft.	8 ft.	8 ft. 6 in.	9 ft.	10 ft.	10 ft. 6 in.	12 ft.
SBN-7	SBN-8	SBN-8.6	SBN-9	SBN-10	SBN-10.6	SBN-12



3/4 inch Radius Bullnose Tape-On Outside Corner

8 ft. Carton	9 ft. Carton	10 ft. Carton	MLF	Pieces/Carton	Cartons/Pallet
ABN-8	ABN-9	ABN-10	95.5 lbs.	50	60



3/4" Radius Bullnose Tape-On Open Angle 135° Outside Corner

8 ft. Carton	9 ft. Carton	10 ft. Carton	12 ft. Carton	MLF	Pcs/Ctn	Ctn/Pal
ABNOA-8	ABNOA-9	ABNOA-10	ABNOA-12	159.5 lbs.	50	60



Extra Large Radius Bullnose Tape-On Outside Corner

MLF: 159.5 lbs. · Pieces per carton: 25 · Cartons per pallet: 52

7 ft.	8 ft. 6 in.	9 ft.	10 ft.	10 ft. 6 in.	12 ft.
ABNXLR-7	ABNXLR-8.6	ABNXLR-9	ABNXLR-10	ABNXLR-10.6	ABNXLR-12



Paperfaced Nail-On Corner Bead

90° Paperfaced Nail-On Extra Extra Wide Even Leg Outside Corner - Sunline™

8 ft. Carton	9 ft. Carton	10 ft. Carton	12 ft. Carton	MLF	Pcs/Ctn	Ctn/Pal
S1XXWN-8	S1XXWN-9	S1XXWN-10	S1XXWN-12	117 lbs.	50	54

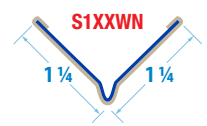

1/2 inch Radius Mini Bull™ Paperfaced Nail-On Outside Corner - Sunline™

8 ft. Carton	9 ft. Carton	10 ft. Carton	MLF	Pieces/Carton	Cartons/Pallet
SMBN-8	SMBN-9	SMBN-10	117 lbs.	50	54

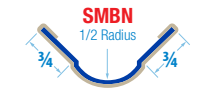

1/2 inch Radius Mini Bull™ Kerf Paperfaced Nail-On Outside Corner - Sunline™

8' 6" Carton	10 ft. Carton	MLF	Pieces/Carton	Cartons/Pallet
SMBN-KERF-8.6	SMBN-KERF-10	117 lbs.	50	60

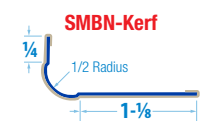

3/4 inch Radius Bullnose Paperfaced Nail-On Outside Corner - Sunline™

8 ft. Carton	9 ft. Carton	10 ft. Carton	MLF	Pieces/Carton	Cartons/Pallet
SBNN-8	SBNN-9	SBNN-10	117.34 lbs.	50	60



3/4 inch Radius Bullnose Paperfaced Nail-On Extra Wide Outside Corner - Sunline™

8 ft. Carton	9 ft. Carton	10 ft. Carton	MLF	Pieces/Carton	Cartons/Pallet
SBNNXW-8	SBNNXW-9	SBNNXW-10	139.03 lbs.	50	54



3/4 inch Radius Kerf Bullnose Paperfaced Nail-On Extra Wide Outside Corner - Sunline™

7 ft. Carton	8' 6" Carton	MLF	Pieces/Carton	Cartons/Pallet
SBNN-KERF-7	SBNN-KERF-10	117.34 lbs.	50	60

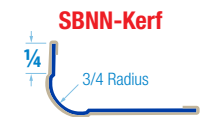

Straight Fascia Gutter 26 Gauge Galvanized Steel

Size	Length	With Wing	No Wing	QTY
2 x 4	10 ft.	216724	-	10
2 x 4	20 ft.	216823	216821	6
2 x 4	25 ft.	216913	216911	6
2 x 4	26 ft.	216923	-	4
2 x 4	30 ft.	216943	-	4
2 x 6	20 ft.	216829	216827	4
2 x 6	25 ft.	216919	216917	4
2 x 6	26 ft.	216929	-	4

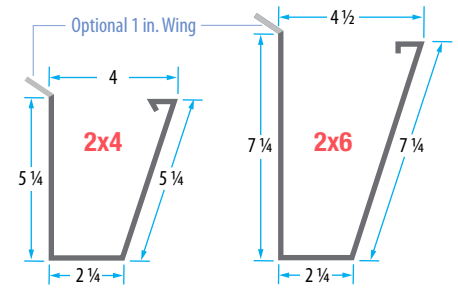

Straight Fascia Gutter 26 Gauge Bonderized Steel

Size	Length	With Wing	No Wing	QTY
2 x 4	10 ft.	FG2410WWB	FG2410NWB	10
2 x 4	16 ft.	FG2416WWB	FG2416NWB	6
2 x 4	20 ft.	FG2420WWB	216822	6
2 x 4	25 ft.	FG2425WWB	216912	6
2 x 4	26 ft.	216924	-	4
2 x 4	30 ft.	216944	-	4
2 x 6	20 ft.	216830	-	4
2 x 6	25 ft.	216920	-	4
2 x 6	26 ft.	216930	-	4
2 x 6	30 ft.	216950	-	4

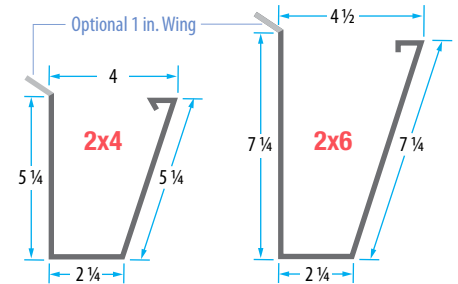

Curved Fascia Gutter 26 Gauge Steel · With wing

Size	Length	Galvanized	Bonderized	QTY
2 x 4	20 ft.	216833	216834	6
2 x 4	25 ft.	216837	176046	6
2 x 4	30 ft.	-	176048	4
2 x 6	25 ft.	-	217178	6
2 x 6 - Tile	25 ft.	-	216895	6

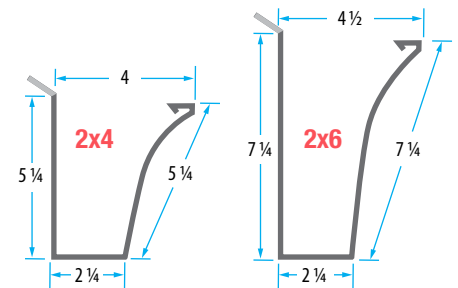

Deco Fascia Gutter 26 Gauge Steel · With wing

With Wing	Length	Galvanized	Bonderized	QTY
2 x 4 - 5 Rib	20 ft.	-	216524	6
2 x 4 - 5 Rib	25 ft.	-	216614	6
2 x 4 - 5 Rib	26 ft.	216623	216624	4
2 x 4 - 5 Rib	30 ft.	-	216644	4
2 x 6 - 7 Rib	20 ft.	-	217108	6
2 x 6 - 7 Rib	25 ft.	217115	217116	6
2 x 6 - 7 Rib - Tile	25 ft.	-	217139	6
2 x 6 - 7 Rib	26 ft.	-	217120	4
2 x 6 - 7 Rib	30 ft.	-	217128	4

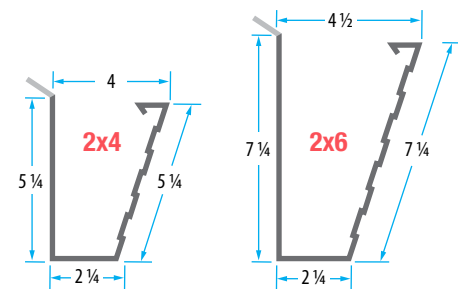

End Caps For Straight & Deco Fascia Gutter · Pack Quantity: 50

Galvanized	
2x4 Left	FG24ECLHG
2x4 Right	FG24ECRHG
2x6 Left	FG26ECLHG
2x6 Right	FG26ECRHG

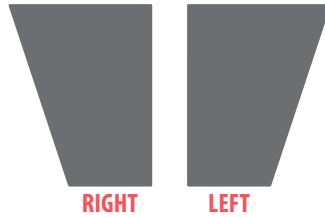

Bonderized	
2x4 Left	FG24ECLHB
2x4 Right	FG24ECRHB
2x6 Left	223035
2x6 Right	223034

Curved End Caps Pack Quantity: 50

Galvanized	
2x4 Left	FG23ECLHCG
2x4 Right	FG23ECLHCG
2x6 Left	FG725ECLHCG
2x6 Right	FG725ECRHCG

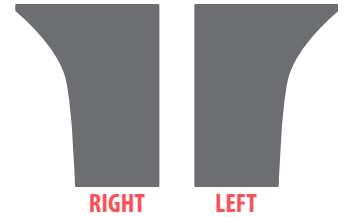

Bonderized	
2x4 Left	FG26ECLHB
2x4 Right	FG26ECRHB
2x6 Left	-
2x6 Right	-

Slip Connectors · Pack Quantity: 25

2x4	Part #
Galvanized	FG24SCG
Bonderized	FG24SCB



End Piece · Pack Quantity: 12

2x4	Bonderized
2-1/4 in. sq. drop	FG24EP214B
2 in. round drop	FG24EPRD2B

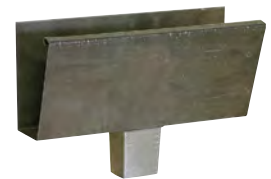

Outside Mitre · Pack Quantity: 12

Galvanized	
2x4	FG24OMG
2x6 - RTO	223041



Bonderized	
2x4	FG24OMB
2x6	-

Inside Mitre · Pack Quantity: 12

Galvanized	
2x4	FG24IMG
2x6 - RTO	223040



Bonderized	
2x4	FG24IMB
2x6	-

Elbows 28 Ga. Bonderized Steel · Pack Quantity: 20

	45°	75°
A - 1 3/4 in. x 2 3/4 in.	CE134234B-A45	CE134234B-A75
B - 1 3/4 in. x 2 3/4 in.	CE134234B-B45	CE134234B-B75
2 in. Round	CERD2B-45	CERD2B-75
3 in. Round - 26 Ga.	CERD3B-45-26	CERD3B-75-26



Conductor Head 26 Gauge · Pack Quantity: 10

Galvanized	
1-3/4 x 2-3/4 Sq. Drop	CH134234G
2 x 3 in. Square Drop	CH3423G
3 x 4 in. Square Drop	CH34G
2 in. Round Drop	CHRD2G
3 in. Round Drop	3LH3GR



Bonderized	
1-3/4 x 2-3/4 Sq. Drop	CH134234B
2 in. Round Drop	CHRD2B
3 in. Round Drop	CHRD3B

Fascia Gutter Hangers 18 Ga. Galvanized · Pack Quantity: 100



Description	2 x 4	2 x 6
Gutter Hanger (Strap)	GH4G-18	GH725G-18
Hidden Hanger	HH24G-18	HAGAH45
Fascia Gutter Spacers	FGS24G-18	223039
Tile Hanger	-	3HTP

K-Style Gutter 26 Gauge

Galvanized	With Wing	No Wing	QTY
4 in x 10 ft.	-	216704	10
4 in x 20 ft.	216807	216803	6
4 in x 25 ft.	216848	-	6
4 in x 26 ft.	216841	-	4
4 in x 30 ft.	216843	-	4
5 in x 20 ft.	216819	216815	6
5 in x 25 ft.	216839	-	6

Bonderized	With Wing	No Wing	QTY
4 in x 20 ft.	216808	216804	6
5 in x 20 ft.	216820	216816	6
5 in x 25 ft.	231417	-	6
5 in x 30 ft.	216844	-	4
6 in x 20 ft.	223419	-	6
6 in x 25 ft.	223420	-	6
6 in x 30 ft.	223421	-	4

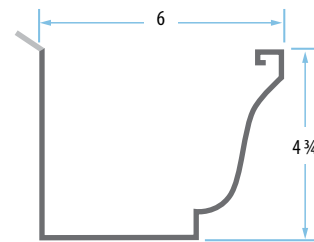
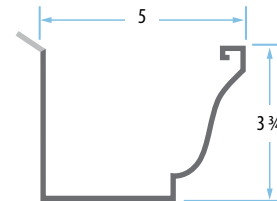
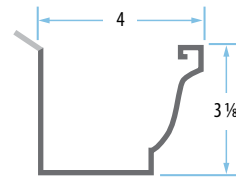

K-Style Gutter 28 Gauge, No Wing, 10 ft. Lengths · Pack Quantity: 10



	Galvanized	Royal Brown	White	White Alum.
4 in.	OG410G	OG410BR	OG410WH	-
5 in.-	-	OG510BR	OG510WH	OG510WHA

Slip Connectors 28 Gauge · Pack Quantity: 30



	Galvanized	Royal Brown	White	White Alum.
4 in.	OG4SCG	OG4SCBR	OG4SCWH	-
5 in.-	-	OG5SCBR	OG5SCWH	OG5SCWHA

Inside Mitre · Pack Quantity: 5



	Galvanized	Royal Brown	White
4 in. Steel	OG4IMG	OG4IMBR	OG4IMWH
5 in Steel	-	OG5IMBR	OG5IMWH
5 in. Aluminum	-	-	OG5IMWHA

Outside Mitre · Pack Quantity: 5



	Galvanized	Royal Brown	White
4 in. Steel	OG4OMG	OG4OMBR	OG4OMWH
5 in Steel	-	OG5OMBR	OG5OMWH
5 in. Aluminum	-	-	OG5OMWHA

End Piece

	Galvanized	Royal Brown	White	QTY
4 in. Steel - with 2 in. Round Drop	OGEP42G	-	-	20
4 in. Steel - with 2 in. x 3 in Drop	OG4EP23G	OG4EP23BR	OG4EP23WH	12
5 in. Steel - with 2 in. x 3 in Drop	-	OG5EP23BR	OG5EP23WH	6
5 in. Alum. - with 2 in. x 3 in Drop	-	-	OG5EP23WHA	5



A-Elbows

	45°	60°	75°	75° Alum.	90°	QTY
1 3/4 in. x 2 3/4 in. - Galvanized	248049	248057	248065	-	248073	20
2 in. x 3 in. - Galv. Corrugated	-	-	CE23G-A75	-	-	15
2 in. x 3 in. - Galvanized	248051	248059	248067	-	248075	20
2 in. x 3 in. - Royal Brown	-	-	CE23BR-A75	-	-	15
2 in. x 3 in. - White - Corrugated	-	-	CE23WH-A75	CE23WHA-A75	-	15



B-Elbows

	45°	75°	75° Corrugated	75° Aluminum	QTY
1-3/4 in. x 2 3/4 in. - Galvanized	248050	248066		-	20
2 in. x 3 in. - Galvanized	-	248068	CE23G-B75	-	20
2 in. x 3 in. - Royal Brown	-	-	CE23BR-B75	-	15
2 in. x 3 in. - White	-	-	CE23WH-B75	CE23WHA-B75	15



Round Elbows 26 Gauge. Pack Quantity: 20

	45°	60°	75°	90°	QTY
2 in. - Galvanized	CERD2G-45	-	CERD2G-75	248184	20
3 in. - Galvanized	248185	248186	CERD3G-75	248188	20
4 in. - Galvanized	248189	248190	248191	248192	20



Drop Outlet 28 Gauge Galvanized Steel

Size	Part#	QTY
1 3/4 in. x 2 3/4 in.	FGDO134234G	25
2 in. x 3 in.	223012	50
3 in. x 4 in.	223013	25
2 in. Round - 26 Gauge	FGDORD2G	25
3 in. Round	FGDORD3G	50
3 in. Round - Half Round Gutter	223079	50
3 in. Oval	3OUT3GKOD	50



Universal Drop Outlet Plastic



2 in. x 3 in. · OGDO23P · QTY: 15

Touch Up Paint 4.5 oz. · Pack Quantity: 6



Brown
TPBR-4



White
TPWH-4

Splash Shield™ Aluminum · 2 per pack



White/Brown · Part #: GGWHA · QTY: 10

End Caps Pack Quantity: 15



	Galvanized	Royal Brown	White	White Aluminum
4 inch - Left	OG4ECLHG	OG4ECLHBR	OG4ECLHWH	-
4 inch - Right	OG4ECRHG	OG4ECRHBR	OG4ECRHWH	-
5 inch - Left	-	OG5ECLHBR	OG5ECLHWH	OG5ECLHWHA
5 inch - Right	OG5ECHR	OG5ECRHBR	OG5ECRHWH	OG5ECRHWHA

Tap-In End Caps

Galvanized Steel
Pack Quantity: 25

	Part #
5" - R	OG5ECRHAPG
5" - L	OG5ECLHTAPG
6" - R	OG6ECRHAPG
6" - L	OG6ECLHTAPG

Spike & Ferrule

10 Pack
Pack Quantity: 12



	Part #
4"-BR	BRS7F4-10PK
4"-GV	GS7F4-10PK
4"-WH	WHS7F4-10PK
5"-BR	BRS7F5-10PK
5"-WH	WHS7F5-10PK

Screw & Ferrule

10 Pack
Pack Quantity: 12



	Part #
5"-BR	BRASR7F5-10PK
5"-WH	WHASR7F5-10PK

Hidden Hanger

18 Gauge · with Screw
Pack Quantity: 100



* without screw

	Part #
4"	HHOG4G-18
5"	HHOG5G-18
5"	222105*
6"	HAGAH6WOL*

Fascia Bracket

4 Pack · Pack Quantity: 12



	Part #
4"-BR	OG4FBBR-4PK
4"-WH	OG4FBWH-4PK
5"-BR	OG5FBBR-4PK
5"-WH	OG5FBWH-4PK

Strap Hanger

18 Gauge · 4 Pack



* QTY: 15 · ** QTY: 100

	Part #
4"	GH4G-18-4*
5"	GH5G-18-4*
5"	3H5GKN**
6"	3H6GKSN**

Gutter Spike

100 Pack
7 in. x 3/16 in.

	Part #
Galvanized	519101

Ferrules

*QTY: 100 · **QTY: 1000

	Part #
4"-GV	GF4EA-100*
6"-BL	FE6BL**

Wire Strainers

Size	Part#	QTY
2 inch dia.	CPWSRD2G	25
2 & 3 inch	248070	216



Silicone Sealant

Size	Part#	QTY
10.1 oz. Tube	SEAMCA10OZ	12



Half Round Gutter 26 Gauge • Single Bead

	With Wing			No Wing		QTY
	Galvanized	Bonderized	Rezibond®	Galvanized	Bonderized	
5 in. x 20 ft.	216106	216751	-	216105	-	6
5 in. x 25 ft.	-	216202	-	-	-	6
6 in. x 20 ft.	216145	216624	216140	216153	-	6
6 in. x 25 ft.	-	216644	216141	-	-	6

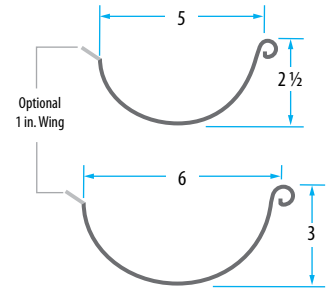

Half Round End Cap Galvanized Steel
Fits both Left & Right



5 inch	QTY	6 inch	QTY
OG5ECHR	30	3EC6GH	100

Shank & Circle Hanger
Fascia Board Mount • Spring Clip Included



5 inch	6 inch	QTY
3SCH5	3SCH6	50

Cross Bar Hanger
Galvanized with 9" or 11" Rods



5 inch Nail	6 inch Nail	QTY
3CS5GHN	3CS6GHN	100

Downspout - Square Galvanized Steel • Pack Quantity: 10

Size	Gauge	Galvanized	Bonderized
1-3/4 in. x 2-3/4 in. x 10 ft.	26	237734	237735
1-3/4 in. x 2-3/4 in. x 11 ft.	26	237903	237904
1-3/4 in. x 2-3/4 in. x 11 ft.	28	-	CP13423411B
1-3/4 in. x 2-3/4 in. x 12 ft.	26	237907	237908
1-3/4 in. x 2-3/4 in. x 20 ft.	26	-	237804
2 in. x 3 in. x 10 ft.	28	237736	-
2 in. x 3 in. x 10 ft. - Corrugated	28	CP2310G	-
2 in. x 3 in. x 10 ft.	26	237738	237740
3 in. x 4 in. x 10 ft.	26	237743	237745
3 in. x 4 in. x 20 ft.x	26	-	237746



Smooth

Corrugated

Painted Downspout 28 Gauge • Pack Quantity: 10

Size	Part#
2 in. x 3 in. x 10 ft. - White Aluminum - Corrugated	CP2310WHA
2 in. x 3 in. x 10 ft. - Royal Brown Steel - Corrugated	CP2310BR
2 in. x 3 in. x 10 ft. - White Steel - Corrugated	CP2310WH

Downspout Extension 2 in. x 3 in. x 15 inch • Pack Quantity: 24

Size	Part#
White Aluminum	CPEXTWHA
White Steel	CP23EXTWH
Royal Brown Steel	CP23EXTBR



Galvanized Downspout - Round 10 ft. lengths • Pack Quantity: 10

Size	30 Gauge	28 Gauge	26 Gauge
2 inch	-	CPRD210G	237702
3 inch	-	237704	237705
4 inch	237776	237707	237708
5 inch	-	237711	-



Bonderized Downspout - Round Pack Quantity: 10

Size	Part #
2 in. x 11 ft. - 28 Gauge	CPRD211B
3 in. x 10 ft. - 26 Gauge	237790
3 in. x 11 ft. - 26 Gauge	CPRD311B-26



Downspout Straps Pack Quantity: 100

Size	Galvanized	Bonderized	QTY
1-3/4 in. x 2-3/4 in. - 26 Ga.	CPS134234G	CPS134234B	Contact Sales
Flat: 2 in. x 3 in. - 26 Ga.	CPS23G	-	Contact Sales
Flat: 2 in. x 3 in. - 28 Ga.	CPSF2G	-	Contact Sales
Flat: 3 in. x 4 in. - 26 Ga.	3PP34G26S	-	Contact Sales
Formed: 3 in. x 4 in. - 26 Ga.	243007	-	Contact Sales
2 in. Round - 26 Ga.	CPSRD2G	CPSRD2B	Contact Sales
3 in. Round - 26 Ga.	CPSRD3G	CPSRD3B	Contact Sales
4 in. Round - 26 Ga.	CPSRD4G	CPSRD4B	Contact Sales



Size	Royal Brown	White	White Aluminum	QTY
Flat: 2 in. x 3 in.	CPSF2BR	CPSF2WH	CPSF2WHA	Contact Sales

Sealant Titebond® Ultimate MP • 10.1 oz • Pack Quantity: 12

Color	Part #	Color	Part #
Translucent	TB-CL71111	Gray	TB-GR71131
Black	TB-BK71091	Brick Red	TB-RD71211
Cocoa Brown	TB-BN71221	Bronze	TB-BR71121
Bone White	TB-WH71201	Evergreen	TB-GN71191



Steel Fascia Gutters



K-Style Gutters



3-Way Roof Edge.....	6	FHA Pipe Flashing.....	17	Roll Flashing, Painted Steel	14
Access Door, Drywall	24	Flat Screen Vent	24	Roof Anchors.....	4
Access Door, Ventilating.....	24	Flat Shingles, Galvanized	15	Roof Brackets.....	4
Aluminum Louvered Vents.....	24	Flat Shingles, Painted	15	Roof Outlet.....	18
Aluminum Mesh.....	21	Flat Stock	15	Roof Starter	7
Bare Metal Corner Bead	32	Flue Guard™, Chimney Cap	18	Rooftop Safety Kit.....	4
Bird Stop.....	9	Foam Plugs.....	26	Rooftop Static Vents.....	23
Butyl Tape.....	4	Foundation Vent, Adjustable.....	26	Roof-to-Wall Flashing	10
Closure Strips	4	Foundation Vent Clips.....	26	Rubber Sleeve Adjustable Pipe Flashing.....	17
Code Caps.....	21	Foundation Vent, Stamped	26	Saddle Stock	9
Conductor Head	34	Gable Louver, Bonderized	19	Screw & Ferrule.....	37
Continuous Soffit Vent.....	25	Gable Louver, Copper.....	19	Scupper	18
Copper Roll	15	Gable Louver, Rectangular	19	Seraph Harness	4
Corrugated Roofing Panels.....	3	Gable Louver, Round.....	20	Shank & Circle Hanger.....	38
Counter Flashing	9	Galvanized Base, Adjustable Pipe Flashing	17	Shock Absorbing Lanyard.....	4
Cross Bar Hanger	38	Gravel Stop.....	7	Siding Corners	13
Damper Doors	26	Grip Edge	6	Silicone Sealant	37
Dormer, Half Round.....	21	Gutter Drop Outlet	36	Soffit Vent	25
Dormer, Low Profile.....	21	Gutter Spike.....	37	Soffit Vent, Flush Mount	25
Dormer, Soft Flange	21	Half Round End Cap	38	Spike & Ferrule.....	37
Dormer, Sub-Base	21	Half Round Gutter	38	Splash Shield™.....	36
Downspout Extension.....	38	Hard Plastic Base, Adjustable Pipe Flashing.....	17	Stealth Vent®.....	22
Downspout, Painted	38	Hidden Hanger.....	37	Stem Vent, Metal.....	22
Downspout, Round	39	HUV Harness.....	4	Stem Vent, Plastic.....	22
Downspout, Square.....	38	J-Vent	20	Step Flashing.....	16
Downspout Straps	39	K-Style Gutter.....	35	Step Flashing, Painted	16
Drip Edge, Bare Metal.....	5	K-Style Gutter Elbows.....	36	Strap Hanger	37
Drip Edge, Hemmed.....	6	K-Style Gutter End Caps.....	37	Style-D Eave Drip.....	8
Drip Edge, Painted	5	K-Style Gutter End Piece.....	36	Tile Hold Down Clip.....	9
Dryer Cap.....	24	K-Style Gutter Inside Mitre.....	35	Tile Pan	8
Drywall Clips.....	27	K-Style Gutter Outside Mitre.....	35	Tile Riser	8
Drywall Corner Bead, Tape-On.....	28	K-Style Gutter Slip Connectors	35	Titebond® Sealant	39
Drywall Furring Hat Channel.....	32	Kwik Mesh™	21	T-Metal	7
Drywall L-Trim, Tape-On	29	L-Flashing, Bare Metal.....	9	Total JACK™.....	20
Drywall Reveal Trim.....	30	L-Flashing, Painted.....	10	Touch Up Paint	36
Drywall Shadow Trim.....	30	Rooftop Safety Lifeline.....	4	T-Top	20
Drywall Shims	32	Millwork Z-Flashing	13	T-Top Sub-Base.....	20
Drywall Squares	27	Mini Louver	24	Two Way Vent Insert	24
Eave Riser.....	8	Moss Control Roll.....	4	Two Way Vents.....	24
Eave Vent	25	Norwesco Reversible Vent	20	Universal Drop Outlet	36
Econo Vent	20	Paperfaced Nail-On Corner Bead	31	Vent Adapter	20
Fascia Bracket.....	37	PBR Panel.....	3	Vent Caps.....	21
Fascia Cap	6	Plastic Roof Vent	22	Vent Wells, Galvanized	27
Fascia Gutter.....	33	Plumber's Flashing.....	18	Vent Wells, Plastic.....	27
Fascia Gutter Elbows	34	Pour-In-Place Foundation Vent	26	Vulcan Vent®.....	25
Fascia Gutter End Caps.....	34	Rain Diverter.....	27	Wire Strainers.....	37
Fascia Gutter End Piece.....	34	Resilient Furring Channel.....	32	Woodfast Screws	4
Fascia Gutter Hangers	34	Ridge Cap	4	W-Valley.....	11
Fascia Gutter Inside Mitre	34	Rim Vent	26	Z-Flashing	12
Fascia Gutter Outside Mitre	34	Roll Flashing, Aluminum.....	14	Zinc Pipe Flashing	17
Fascia Gutter Slip Connectors	34	Roll Flashing, Galvanized	14		
Ferrules	37	Roll Flashing, Painted Aluminum.....	14		