



R.F. Williams, Michigan Master Plumber, License No. 04287 (left)  
R.M. Williams, Michigan Master Plumber, License No. 05275 (right)

In the late 1950's, Robert F. Williams had the idea of utilizing plastics for plumbing systems that could be installed by individuals who may not possess any plumbing skills. As a result of the innovative idea came the creation of Genova.

Williams' background as a licensed master plumber made him an expert in the field of plastics. His extensive knowledge made him eminently qualified to dispel the mysteries of plumbing to the average homeowner. Williams' goal was to make home plumbing something homeowners could easily do themselves.

Since that early beginning, complete lines of Genova pipe and fittings have been developed by the senior Williams and his son, R.M. Williams, current Genova chairman who is also a licensed master plumber.

Mr. Williams was able to see his goal achieved before he died in 1992. Vinyl plumbing is not only easy to install,

but the pure virgin vinyl utilized in Genova products lasts longer and works better than other plumbing systems. The company has continued to diversify into other labor saving products, such as vinyl raingutters, fencing, decking, railing and lattice.

Genova has grown from the idea of a single entrepreneur into a dedicated group of people committed to serving the needs of do-it-yourselfers everywhere and those dealers who serve them. The corporate motto is "The People Who Get It Done!" and every employee is committed to the pursuit of that goal.

For do-it-yourselfers as well as pros, Genova is the only way to go in home plumbing and vinyl building materials.



**100 Series**

Solvents & Roof Flashings.....1  
 Polypropylene Tubular Products.....5

**300 Series**

PVC Pressure Pipe & Fittings.....11  
 Nipples.....13  
 PVC Sch. 40 Pressure Fittings.....15  
 PVC Sch. 80 Pressure Fittings.....26

**350-380 Series**

Plastic & Steel Insert Fittings.....31

**400 Series**

PVC Sewer Pipe, PVC & Styrene Fittings.....39  
 Corrugated Fittings.....46

**500 Series**

CPVC Pipe & Fittings.....49  
 Flowguard Gold® Pipe & Fittings.....60  
 Universal Fittings.....65  
 Specialty Items for Use With CPVC.....70

**600 Series**

Sch. 30 PVC-DWV Pipe & Sch. 30 Fittings.....71  
 Sch. 30 PVC-DWV Specialty Items.....76

**700 Series**

Sch. 40 PVC-DWV Pipe & Fittings.....79  
 Specialty Items For Use With Sch. 40.....94

**800 Series**

ABS-DWV Pipe & Fittings.....97

**900 Series**

Polyethylene Pipe.....109  
 Check Valves.....110  
 Furniture Fittings.....111  
Raingo®.....113  
Repla K®.....116  
 Duraspout Downspout.....117  
 Vinyl Gutter & Downspout Accessories.....119  
 Custom Gutter Corner Order Sheet.....120  
 Marine/RV Filter/Softener.....121  
 Merchandising Aides.....123  
 Product Warranties.....127



# SOLVENTS & ROOF FLASHINGS

Solvent welding is the most economical and safest way to install plumbing pipe and fittings. Used to join ABS, CPVC, PVC, and Styrene.

- All solvents come with daubers.



## SOLVENT CEMENT REQUIREMENTS (Average # of Solvent Welded Joints)

Pipe/Fitting Size	¼ Pint	Pint
½"	63	255
¾"	42	170
1½"	17	68
2"	9	38
3"	7	30
4"	5	21
6"	1	7

The above figures are estimates and will vary with individual applications.

Material	Cleaner	All Purpose Cement	CPVC Cement	PVC Cement	Weather-All	ABS Cement	Purple Primer	Flow-Tite Yellow CPVC Cement
ABS	R	R	-	-	R	R	-	-
CPVC	R	R	R	-	-	-	R	R
PVC	R	R	-	R	-	-	R	-
STYRENE	R	R	-	R	R	R	-	-
PEX/PB	-	-	-	-	-	-	-	-
NSF LISTED	NO	NO	YES	YES	NO	YES	YES	YES
ASTM	NA	F493	F493	D2564	D2564	D2235	F656	F493

Phone: 1-800-521-7488 or (810) 744-4500  
 Fax: (810) 744-3130  
 Email: inquiry@genovaproducts.com  
 Hours: 8 AM to 5 PM EST Monday - Friday

**PURPLE PRIMER**

Recommended for use with PVC and CPVC, in areas where a colored primer is required by local plumbing codes.

Part #	Size	Pkg Qty	Box Qty	Box Wt
13110	¼ Pint	4 oz.	12	4
13111	½ Pint	8 oz.	10	6
13115	Pint	16 oz.	6	7
13120	Quart	32 oz.	4	9

**CLEANER/PRIMER**

Recommended for use with PVC, CPVC, ABS and Styrene. Also known as the "Universal" cleaner.

Part #	Size	Pkg Qty	Box Qty	Box Wt
14010	¼ Pint	4 oz.	12	4
14011	½ Pint	8 oz.	10	6
14015	Pint	16 oz.	6	7
14020	Quart	32 oz.	4	9

**CPVC CEMENT (ORANGE)**

Recommended for CPVC. Can be used on PVC, ABS and Styrene.

Part #	Size	Pkg Qty	Box Qty	Box Wt
14110	¼ Pint	4 oz.	12	5
14111	½ Pint	8 oz.	10	7
14115	Pint	16 oz.	6	8

**"WEATHER-ALL" PVC CEMENT****(COLD WEATHER)**

Recommended for use in freezing temperatures with PVC. Can be used on ABS.

Part #	Size	Pkg Qty	Box Qty	Box Wt
14415	Pint	16 oz.	6	8

**PVC CEMENT**

Recommended for PVC and Styrene. Can be used on ABS.

Part #	Size	Pkg Qty	Box Qty	Box Wt
14910	¼ Pint	4 oz.	12	5
14911	½ Pint	8 oz.	10	7
14915	Pint	16 oz.	6	8
14920	Quart	32 oz.	4	10

**ALL PURPOSE CEMENT**

Recommended for solvent welding of CPVC, PVC, ABS or Styrene. Also known as the "Universal" cement.

Part #	Size	Pkg Qty	Box Qty	Box Wt
15010	¼ Pint	4 oz.	12	5
15011	½ Pint	8 oz.	10	7
15015	Pint	16 oz.	6	8
15020	Quart	32 oz.	4	10

**ONE-STEP CPVC CEMENT (YELLOW)**

Recommended for one-step solvent welding CPVC.

Part #	Size	Pkg Qty	Box Qty	Box Wt
15210	¼ Pint	4 oz.	12	5
15211	½ Pint	8 oz.	10	7

**ABS CEMENT**

Recommended for use with ABS and Styrene.

Part #	Size	Pkg Qty	Box Qty	Box Wt
16010	¼ Pint	4 oz.	12	4
16011	½ Pint	8 oz.	10	6

**"SNAP-FIT®" THERMOPLASTIC ROOF FLASHINGS**

These weatherproof thermoplastic flashings, featuring a replacement boot, provide seal around plumbing vent pipes. Manufactured totally from corrosion proof materials. They eliminate shingle staining problems. Can be used on all types of plumbing pipes and electrical conduit. Base dimensions (14661) 8½" X 11¾", (14562-64) 12" X 16".

Part #	Size	Box Qty	Box Wt
14661	1¼" - 2"	10	5
14562	2"	10	9
14563	3"	10	9
14564	4"	10	9



# POLYPROPYLENE TUBULAR PRODUCTS

Tubular products are made of polypropylene and are used for drainage applications from the fixture to the drain pipe.



- Polypropylene is heat and chemical resistant and outperforms metal and plastic alternatives.
- Install Tubular products using slip joints, do not solvent weld.
- Use silicone sealant and plumber's putty on all slip jamnut washer connections.
- All parts come merchandised in colored bags with installation instructions and bar code.
- Refer to the 700 and 800 series product lines for Sch. 40 PVC and ABS traps and trap adapters.

Phone: 1-800-521-7488 or (810) 744-4500  
Fax: (810) 744-3130  
Email: [inquiry@genovaproducts.com](mailto:inquiry@genovaproducts.com)  
Hours: 8 AM to 5 PM EST Monday - Friday

**FLANGED TAILPIECE**

Attaches directly to sink strainers to extend drain tubes.

Part #	Size	Box Qty	Box Wt
186041	1½" x 1¼"	5	1
138061	1½" x 6"	5	1
138121	1½" x 12"	5	2

**ADJUSTABLE TAILPIECE**

Used to extend drain tubes, attaches directly to Tubular Tailpiece.

Part #	Size	Box Qty	Box Wt
137501	1¼" x 6"	5	1
138501	1½" x 6"	5	1
138301	1½" x 12"	5	2

**DISHWASHER TAILPIECE (INLET)**

Used for hooking up automatic dishwasher drains to exposed sink drains in installations not employing garbage disposal. Branch accepts 7/8" I.D. hose or rubber dishwasher drain connectors

Part #	Size	Box Qty	Box Wt
138401	1½" x 8" x 7/8"	5	2

**DISHWASHER/DISPOSAL CONNECTOR W/CLAMPS**

Connects a dishwasher hose to drain inlet or disposal unit.

Part #	Size	Box Qty	Box Wt
138451	1" / 7/8" x 7/8" / 5/8"	5	2

**DISPOSER KIT**

Fits any drain system. Designed to connect double compartment sinks that have a Garbage Disposal into a single trap. This unique unit can be assembled directly to sink strainer and disposal. Features a baffle in the tee to prevent back ups.

Part #	Size	Box Qty	Box Wt
138471	1½" x 15"	10	4

**BAFFLE TEE**

Used to connect garbage disposal discharge into kitchen sink drain, using the existing trap. Baffle prevents disposer discharge from backing up into the other sink.

Part #	Size	Box Qty	Box Wt
186301	1½"	5	2

**SLIP COUPLER**



Adaptable 1½" x 1¼" washer included. Can be utilized to connect 1½" tubes, 1¼" tubes, as well as adapt from 1½" to 1¼" tubes.

Part #	Size	Box Qty	Box Wt
138601	1½"/1¼"	5	1

**90° SLIP COUPLER**



Adaptable 1½" x 1¼" washer included. Can be utilized to connect 1½" tubes, 1¼" tubes, as well as adapt from 1½" to 1¼" tubes. Allows for changes in direction and realignment of exposed tubular piping.

Part #	Size	Box Qty	Box Wt
138701	1½"/1¼"	5	1

**TEE SLIP COUPLER**



Adaptable 1½" x 1¼" washer included. Can be utilized to connect 1½" tubes, 1¼" tubes, as well as adapt from 1½" to 1¼" tubes. Connects multiple sinks or vanities into a single drain.

Part #	Size	Box Qty	Box Wt
138801	1½"/1¼"	5	2

**45° SLIP COUPLER**



Adaptable 1½" x 1¼" washer included. Can be utilized to connect 1½" tubes, 1¼" tubes, as well as adapt from 1½" to 1¼" tubes. Coupler allows for changes in direction and realignment of exposed tubular piping.

Part #	Size	Box Qty	Box Wt
138901	1½"/1¼"	5	2

**WASHBASIN J-BEND**



Replaces conventional washbasin J-Bends.

Part #	Size	Box Qty	Box Wt
171121	1¼"	5	1

**J-BEND**



Adaptable 1½" x 1¼" washer included. Can be utilized to connect 1½" tubes, 1¼" tubes, as well as adapt from 1½" to 1¼" tubes. Replaces conventional sink traps.

Part #	Size	Box Qty	Box Wt
171161	1½"/1¼"	5	2

**WASHBASIN P-TRAP**



Connects washbasin to DWV piping system.

Part #	Size	Box Qty	Box Wt
175141	1¼"	10	3

**SINK P-TRAP**

Adaptable 1 1/2" x 1/4" washer included. Can be utilized to connect 1 1/2" tubes, 1/4" tubes, as well as adapt from 1 1/2" to 1/4" tubes. Connects sink to DWV piping system.

Part #	Size	Box Qty	Box Wt
175151	1 1/2"/1/4"	5	2

**SINK P-TRAP W/TRANSITION ADAPTER**

Adaptable 1 1/2" x 1/4" washer included. Can be utilized to connect 1 1/2" tubes, 1/4" tubes, as well as adapt from 1 1/2" to 1/4" tubes. Connects sink to DWV piping system.

Part #	Size	Box Qty	Box Wt
175161	1 1/2"/1/4"	25	10

**P-TRAP W/SOLVENT WELD ELBOW**

Adaptable 1 1/2" x 1/4" washer included. Can be utilized to connect 1 1/2" tubes, 1/4" tubes, as well as adapt from 1 1/2" to 1/4" tubes. Furnished with special PVC elbow to allow solvent welding directly to 1 1/2" Sch. 40 pipe.

Part #	Size	Box Qty	Box Wt
176151	1 1/2" x 1 1/2"/1/4"	5	2

**ANTI-SIPHON P-TRAP (BUILT IN VENT)**

Combines the NovaVent™ anti-siphon valve and P-trap into a compact single unit. The anti-siphon trap provides a simple way of solving waste pipe drainage problems caused by inadequate plumbing system venting. Replaces almost any current fixture trap.

Part #	Size	Box Qty	Box Wt
178151	1 1/2"	10	6

**S-TRAP**

Used in kitchen sink and washbasin applications where plumbing connection is made at floor. Adaptable 1 1/2" x 1/4" washer included in P/N 177151. Can be utilized to connect 1 1/2" tubes, 1/4" tubes, as well as adapt from 1 1/2" to 1/4" tubes.

Part #	Size	Box Qty	Box Wt
177141	1/4"	5	3
177151	1 1/2" x 1/4"	5	4

**END OPENING CONTINUOUS WASTE (ADJUSTABLE - DIRECT CONNECT)**

Connects double compartment sinks into a single trap located to one side under the sink. Can be assembled directly to sink strainers or tailpiece pipes. Features a removable baffle.

Part #	Size	Box Qty	Box Wt
186001	1 1/2"	5	3

**CENTER OPENING CONTINUOUS WASTE**  
(ADJUSTABLE - DIRECT CONNECT)



Connects double compartment sinks into a single trap located in the center under the sink. Connects directly to sink strainers or tailpiece pipes.

Part #	Size	Box Qty.	Box Wt.
186101	1½"	5	3

**BATHTUB TRIP LEVER WASTE**



Made of heavy-duty PVC with chrome plated face plate and strainer. Easy to Install, it adjusts to any standard size bathtub.

Part #	Size	Box Qty	Box Wt
19015	1½"	1	2

**PVC DYNAMIC DUO™ TRAP ADAPTER**



Adaptable 1½" x 1¼" washer included. Can be utilized to connect 1½" tubes, 1¼" tubes, as well as adapt from 1½" to 1¼" tubes. Solvent welds to 1½" Sch.40 drain pipe and connects via slip jamnut to either 1½" or 1¼" tubular traps. Eliminates the need for stocking extra trap adapter configurations.

Part #	Size	Box Qty	Box Wt
722151	1½" x 1¼" /1½"	5	1

**SLIP JAMNUT**



Interchanges with metal or plastic jamnuts. Special design allows tightening without tools.

Part #	Size	Box Qty	Box Wt
147141	1¼"	10	1
147151	1½"	10	1

**ASSORTED SLIP WASHERS**



Ideal for sealing applications when used with slip jamnuts. Package assortment includes: (2) - 1½" x 1¼" Reducing Washers, (2) - 1½" Slip washers, and (2) - 1¼" Slip Washers.

Part #	Box Qty	Box Wt
148001	10	1



# PVC PRESSURE PIPE & FITTINGS

PVC Pressure Pipe & Fittings are used in outside cold water pressure applications. Schedule 40 is used in applications, such as irrigation, underground residential sprinkler systems, water service pipe, deionized water lines, swimming pool installations, and some chemical drainage systems. Sch. 80 fittings are used with chemical processing, industrial plating, chilled water distribution, chemical drainage, and other high pressure fluid applications.



## Pressure Pipe

- SDR Pipe meets ASTM D2241
- Sch. 40 PVC Pipe meets ASTM D1785
- Sch. 80 PVC Pipe meets ASTM D1785
- Sch. 40 PVC Pipe 1½" and larger is dual rated for pressure (ASTM 1785) and drainage (ASTM 2665) applications.
- Belled pipe ends meet ASTM D2672 (Pipe measures 20' before beelling)
- NSF Listed (except class rated pipe)

## Sch. 40 Pressure Fittings

- Meets ASTM D2466
- NSF Listed

## Sch. 80 Pressure Fittings

- Meets ASTM D2467
- NSF Listed

- Pipe diameters are the same as iron pipe. (IPS = Iron Pipe Size)
- Solvent weld joints.
- Pressure pipe and fittings are for use in the distribution of pressurized fluids only, which are chemically compatible with the piping materials.
- Pipe produced to a Standard Dimensional Ratio (SDR) has a wall thickness that is proportional to its diameter and all sizes have the same pressure rating; the pressure rating for Schedule pipe decreases as the diameter increases.

Phone: 1-800-521-7488 or (810) 744-4500  
 Fax: (810) 744-3130  
 Email: [inquiry@genovaproducts.com](mailto:inquiry@genovaproducts.com)  
 Hours: 8 AM to 5 PM EST Monday - Friday

**PVC PRESSURE PIPE**

(SCH.40 AND SDR)

(Cold Water Use Only)



Part #	Size			Pressure Rating at 73°F (PSI)	Bdl Qty (lgths)	Box Qty (lgths)	Bdl Wt (lbs)
30005	½" x 20'	(SDR 13.5)	Belled End	315	10	240	21
31005	½" x 10'	(SDR 13.5)	Plain End	315	10	480	11
30007	¾" x 20'	(SDR 21)	Belled End	200	10	200	26
31007	¾" x 10'	(SDR 21)	Plain End	200	10	400	13
30010	1" x 20'	(SDR 21)	Belled End	200	10	240	34
31010	1" x 10'	(SDR 21)	Plain End	200	10	240	17
30011	1¼" x 20'	(SDR 21)	Belled End	200	5	180	26
31011	1¼" x 10'	(SDR 21)	Plain End	200	5	180	13
30012	1½" x 20'	(SDR 21)	Belled End	200	5	200	34
31012	1½" x 10'	(SDR 21)	Plain End	200	5	200	17
30022	2" x 20'	(SDR 21)	Belled End	200	5	150	53
31022	2" x 10'	(SDR 21)	Plain End	200	5	150	27
300057	½" x 20'	(Sch. 40)	Belled End	600	10	240	33
310057	½" x 10'	(Sch. 40)	Plain End	600	10	480	17
300058	½" x 20'	(Sch. 40)	Plain End	600	10	240	33
300077	¾" x 20'	(Sch. 40)	Belled End	480	10	200	43
310077	¾" x 10'	(Sch. 40)	Plain End	480	10	400	22
300078	¾" x 20'	(Sch. 40)	Plain End	480	10	200	43
300107	1" x 20'	(Sch. 40)	Belled End	450	10	240	65
310107	1" x 10'	(Sch. 40)	Plain End	450	10	240	33
300108	1" x 20'	(Sch. 40)	Plain End	450	10	240	65
300117	1¼" x 20'	(Sch. 40)	Belled End	370	5	180	44
310117	1¼" x 10'	(Sch. 40)	Plain End	370	5	180	22
300118	1¼" x 20'	(Sch. 40)	Plain End	370	5	180	44
300127	1½" x 20'	(Sch.40)	Belled End	330	5	200	54
70011	1½" x 10'	(Sch. 40)	Plain End	330	5	180	27
300227	2" x 20'	(Sch. 40)	Belled End	280	5	150	73
70021	2" x 10'	(Sch. 40)	Plain End	280	5	140	35
310257	2½" x 10'	(Sch. 40)	Plain End	300	5	150	56
34011	1¼" x 20'	(SDR 26)	Belled End	160	5	180	21
35011	1¼" x 10'	(SDR 26)	Plain End	160	5	180	11
34012	1½" x 20'	(SDR 26)	Belled End	160	5	200	28
35012	1½" x 10'	(SDR 26)	Plain End	160	5	200	14
34022	2" x 20'	(SDR 26)	Belled End	160	5	150	43
35022	2" x 10'	(SDR 26)	Plain End	160	5	150	22
34032	3" x 20'	(SDR 26)	Belled End	160	5	75	93
34042	4" x 20'	(SDR 26)	Belled End	160	5	40	146
300077R*	¾" x 20'	(Sch. 40)	Belled End	480	10	200	43
300107R*	1" x 20'	(Sch. 40)	Belled End	450	10	240	65

## SCH. 80 NIPPLES (MIP X MIP)



Used for sprinkler systems where an extension is needed for the sprinkler head to be above ground level. Also may be used to prevent damage to the sprinkler head. PTFE thread tape is recommended for threaded joints.

Part #	Size	Pkg Qty	Box Qty	Box Wt
383001	½" X 1 <sup>3</sup> / <sub>8</sub> " (C)	10	50	2
3403015	½" X 1½" (S)		50	2
383020	½" x 2"	10	50	2
3403025	½" x 2½"		50	2
3403030	½" x 3"		50	3
3403035	½" x 3½"		50	3
3403040	½" x 4"		50	4
3403045	½" x 4½"		50	4
3403050	½" x 5"		25	3
383060	½" x 6"	10	50	6
3403080	½" x 8"		25	4
3403100	½" x 10"		25	5
383120	½" x 12"	10	50	11
3403180	½" x 18"		25	8
3403240	½" x 24"		10	5
3403360	½" x 36"		10	6
3403480	½" x 48"		10	8
384001	¾" x 1 <sup>3</sup> / <sub>8</sub> " (C)	10	50	2
384020	¾" x 2"	10	50	3
3404025	¾" x 2½"		50	3
3404030	¾" x 3"		50	4
384040	¾" x 4"	10	50	6
3404050	¾" x 5"		25	3
384060	¾" x 6"	10	50	8
3404080	¾" x 8"		25	5
3404100	¾" x 10"		25	6
384120	¾" x 12"	10	50	17
3404180	¾" x 18"		10	6
3404240	¾" x 24"		10	7
3404360	¾" x 36"		10	10
3404480	¾" x 48"		10	12

(Continued....)

Part #	Size	Pkg Qty	Box Qty	Box Wt
3405001	1" x 1½" (C)		50	3
3405020	1" x 2" (S)		50	4
3405030	1" x 3"		50	5
3405040	1" x 4"		25	4
3405050	1" x 5"		25	5
3405060	1" x 6"		25	6
3405080	1" x 8"		25	7
3405100	1" x 10"		25	8
3405120	1" x 12"		25	10
3406001	1¼" x 1-5/8" (C)		25	3
3406020	1¼" x 2" (S)		25	3
3406025	1¼" x 2½"		25	3
3406030	1¼" x 3"		25	4
3406040	1¼" x 4"		25	5
3406050	1¼" x 5"		25	12
3406060	1¼" x 6"		25	8
3406080	1¼" x 8"		25	10
3406100	1¼" x 10"		20	10
3406120	1¼" x 12"		20	12
3407001	1½" x 1¾" (C)		25	3
3407020	1½" x 2" (S)		25	4
3407025	1½" x 2½"		25	4
3407030	1½" x 3"		25	5
3407040	1½" x 4"		25	7
3407050	1½" x 5"		25	9
3407060	1½" x 6"		25	9
3407080	1½" x 8"		25	13
3407100	1½" x 10"		15	9
3407120	1½" x 12"		15	11
3408001	2" x 2"(C)		25	5
3408025	2" x 2½" (S)		25	6
3408030	2" x 3"		25	7
3408040	2" x 4"		25	9
3408050	2" x 5"		25	12
3408060	2" x 6"		25	13
3408080	2" x 8"		25	17
3408100	2" x 10"		10	8
3408120	2" x 12"		10	10

**PE NIPPLES (MIP X MIP)**

Part #	Size	Pkg Qty	Box Qty	Box Wt
3303020	½" x 2"	10	50	1
3303030	½" x 3"	10	250	7
3303040	½" x 4"	10	250	11

**COUPLING (SLIP X SLIP)**

Used to join lengths of pipe.

Part #	Size	Pkg Qty	Box Qty	Box Wt
30105	½"	25	600	25
30107	¾"	25	300	14
30110	1"	10	300	22
30114	1¼"	25	150	15
30115	1½"	10	120	17
30120	2"	10	50	11
30190	2½"		10	6
30130	3"		10	8
30140	4"		5	6
30160	6"		5	13

**COUPLING (SLIP X SLIP) CONTRACTOR PACK**

Conveniently packaged in quantities of 10.

Part #	Size	Box Qty	Box Wt
30105CP	½"	50	17
30107CP	¾"	25	12
30110CP	1"	10	8

**REDUCING COUPLING (SLIP X SLIP)**

Used to reduce or increase pipe sizes.

Part #	Size	Box Qty	Box Wt
30175	¾" x ½"	50	3
30117	1 x ¾"	50	5

**EXTENDED SOCKET COUPLING (SLIP X SLIP)**

Used to join lengths of pipe.

Part #	Size	Pkg Qty	Box Qty	Box Wt
E30105	½"	25	600	24
E30107	¾"	25	300	17
E30110	1"	10	300	23
E30114	1¼"		25	4
E30115	1½"		25	4
E30120	2"		25	6

**THREADED COUPLING (FIP X FIP)**

Used for joining sections of threaded pipe and/or nipples. PTFE thread tape is recommended for threaded joints.

Part #	Size	Pkg Qty	Box Qty	Box Wt
30125	½"	10	400	19
30127	¾"	10	300	21
30128	1"	10	300	31

**CAP (SLIP)**

Used to cap pipe.

\* Caps are designed with dome shaped top.

Part #	Size	Pkg Qty	Box Qty	Box Wt
30155	½"	10	600	15
30157	¾"	10	600	20
30158	1"	10	300	18
30159	1¼"	25	300	25
30151	1½"	10	120	14
30152	2"	10	120	20
30150*	2½"		10	4
30153*	3"		10	6
30154*	4"		5	5
30156*	6"		5	11

**CAP (SLIP) CONTRACTOR PACK**

Conveniently packaged in quantities of 10.

Part #	Size	Box Qty	Box Wt
30155CP	½"	60	15
30157CP	¾"	60	20
30158CP	1"	10	7

**CAP (FIP)**

Used to cap threaded pipe. Adapts to standard male pipe threads. PTFE thread tape is recommended for threaded joints.

\* Caps are designed with dome shaped top.

Part #	Size	Pkg Qty	Box Qty	Box Wt
30165	½"	10	600	17
30167	¾"	10	400	15
30168	1"	10	300	20
30169	1¼"	25	150	15
30161	1½"	25	150	20
30162	2"	10	50	11
30163*	3"		10	6
30166*	4"		5	4

**PLUG (MIP)**

Adapts to standard female pipe threads. PTFE thread tape is recommended for threaded joints.

Part #	Size	Pkg Qty	Box Qty	Box Wt
31805	½"	10	400	11
31807	¾"	10	400	16
31810	1"	10	400	24
31814	1¼"		25	3
31815	1½"		25	3
31820	2"		10	2
31890	2½"		10	3
31829	3"		10	5
31839	4"		5	4

## PLUG (SPIGOT)



Solvent welds directly into fitting socket to form permanent closure.

Part #	Size	Pkg Qty	Box Qty	Box Wt
31825	½"	10	300	9
31827	¾"	10	300	9
31830	1"	10	200	12
31834	1¼"		25	3
31835	1½"		25	3
31840	2"		10	2
31845	2½"		10	4
31850	3"		10	5
31860	4"		5	4

## REDUCING BUSHING (SPIGOT X SLIP)



Inserts into fitting hub to reduce to smaller pipe size.

Part #	Size	Pkg Qty	Box Qty	Box Wt
30275	¾" x ½"	10	400	11
30215	1" x ½"	10	400	20
30217	1" x ¾"	10	400	16
30245	1¼" x ½"		25	3
30247	1¼" x ¾"	25	300	27
30240	1¼" x 1"	25	300	19
30255	1½" x ½"		25	3
30257	1½" x ¾"	10	120	15
30250	1½" x 1"	10	120	14
30254	1½" x 1¼"	10	120	9
30225	2" x ½"		10	2
30227	2" x ¾"		10	2
30220	2" x 1"	10	120	23
30224	2" x 1¼"	10	120	22
30221	2" x 1½"	10	120	17

Part #	Size	Pkg Qty	Box Qty	Box Wt
30290	2½" x 1"		10	4
30291	2½" x 1½"		10	4
30292	2½" x 2"		10	3
30234	3" x 1¼"		10	5
30231	3" x 1½"		10	5
30232	3" x 2"		10	5
30239	3" x 2½"		10	5
30242	4" x 2"		5	4
30249	4" x 2½"		5	5

## REDUCING BUSHING (MIP X FIP)



Inserts into threaded fitting socket to reduce to smaller threaded opening. PTFE thread tape is recommended for threaded joints.

Part #	Size	Pkg Qty	Box Qty	Box Wt
34351	½" x ¼"		50	2
34375	¾" x ½"	10	300	8
34315	1" x ½"	10	200	10
34317	1" x ¾"	10	200	8
34345	1¼" x ½"		25	4
34347	1¼" x ¾"		25	3
34340	1¼" x 1"		25	3
34355	1½" x ½"		25	4
34357	1½" x ¾"		25	3
34350	1½" x 1"		25	3
34354	1½" x 1¼"		25	2
34320	2" x 1"		10	3
34324	2" x 1¼"		10	2
34321	2" x 1½"		10	2

**REDUCING BUSHING (SPIGOT X FIP)**

Inserts into fitting hub to reduce to standard male pipe threads. PTFE thread tape is recommended for threaded joints.

Part #	Size	Pkg Qty	Box Qty	Box Wt
34259	½" x 1/8"		100	3
34251	½" x ¼"		100	3
34275	¾" x ½"	10	400	14
34215	1" x ½"	10	400	22
34217	1" x ¾"	10	400	18
34245	1¼" x ½"		25	4
34247	1¼" x ¾"		25	3
34240	1¼" x 1"		25	3
34255	1½" x ½"		25	3
34257	1½" x ¾"		25	4
34250	1½" x 1"		25	4
34254	1½" x 1¼"		25	3
34225	2" x ½"		10	2
34227	2" x ¾"		10	3
34220	2" x 1"		10	3
34224	2" x 1¼"		10	2
34221	2" x 1½"		10	2
34291	2½" x 1½"		10	4
34292	2½" x 2"		10	3
34232	3" x 2"		10	5
34239	3" x 2½"		10	5
34249	4" x 2½"		5	5

**FEMALE ADAPTER (SLIP X FIP)  
CONTRACTOR PACK**

Conveniently packaged in quantities of 10.

Part #	Size	Box Qty	Box Wt
30305CP	½"	50	18
30307CP	¾"	25	12
30310CP	1"	10	9

**FEMALE ADAPTER (SLIP X FIP)**

Adapts pressure pipe to standard male pipe threads. PTFE thread tape is recommended for threaded joints.

Part #	Size	Pkg Qty.	Box Qty	Box Wt
30305	½"	10	500	18
30307	¾"	10	300	14
30310	1"	10	300	25
30314	1¼"	25	150	17
30315	1½"	10	120	19
30320	2"	10	50	11
30390	2½"		10	6
30330	3"		10	8
30340	4"		5	5
30360	6"		4	10

**REDUCING FEMALE ADAPTER (SLIP X FIP)**

Adapts pressure pipe to standard male pipe threads. Fitting reduces to smaller pipe size. PTFE thread tape is recommended for threaded joints.

Part #	Size	Pkg Qty	Box Qty	Box Wt
30357	½" x ¾"		50	3
30375	¾" x ½"	10	150	8
30376	¾" x 1"		50	4
30377	1" x ¾"		50	4

**MALE ADAPTER (SLIP X MIP)**

Adapts pressure pipe to standard female pipe threads. PTFE thread tape is recommended for threaded joints.

Part #	Size	Pkg Qty	Box Qty	Box Wt
30405	½"	10	500	16
30407	¾"	10	300	13
30410	1"	10	300	22
30414	1¼"	25	150	16
30415	1½"	10	120	16
30420	2"	10	50	10
30490	2½"		10	5
30430	3"		10	6
30440	4"		5	5
30460	6"		4	10

**MALE ADAPTER (SLIP X MIP) CONTRACTOR PACK**

Conveniently packaged in quantities of 10.

Part #	Size	Box Qty	Box Wt
30405CP	½"	50	16
30407CP	¾"	25	11
30410CP	1"	10	8

**REDUCING MALE ADAPTER (SLIP X MIP)**

Adapts pressure pipe to standard female pipe threads. PTFE thread tape is recommended for threaded joints.

Part #	Size	Pkg Qty	Box Qty	Box Wt
30457	½" x ¾"	10	150	7
30475	¾" x ½"	10	300	12

Part #	Size	Pkg Qty	Box Qty	Box Wt
30476	¾" x 1"	10	100	8
30477	1" x ¾"		50	4
30441	1" x 1¼"		25	3
30404	1¼" x 1"		25	3
30454	1¼" x 1½"		25	4
30452	1½" x 1¼"		25	4
30421	1½" x 2"		10	2
30412	2" x 1½"		10	2

**45° ELBOW (SLIP X SLIP)**

Used to change direction in piping.

Part #	Size	Pkg Qty	Box Qty	Box Wt
30605	½"	10	300	12
30607	¾"	10	300	18
30610	1"	10	200	19
30614	1¼"	10	120	17
30615	1½"	10	50	11
30620	2"	5	50	15
30690	2½"		10	8
30630	3"		10	10
30640	4"		5	8
30660	6"		4	18

**90° ELBOW (SLIP X SLIP)**

Used to change direction in piping.

Part #	Size	Pkg Qty	Box Qty	Box Wt
30705	½"	10	300	18
30707	¾"	10	250	21
30710	1"	10	120	17
30714	1¼"	10	50	11
30715	1½"	10	50	15
30720	2"	5	50	23

Part #	Size	Pkg Qty	Box Qty	Box Wt
30790	2½"		10	10
30730	3"		10	14
30740	4"		5	10
30760	6"		4	22

### 90° ELBOW (SLIP X SLIP) CONTRACTOR PACK



Conveniently packaged in quantities of 10.

Part #	Size	Box Qty	Box Wt
30705CP	½"	50	29
30707CP	¾"	20	17
30710CP	1"	10	15

### REDUCING 90° ELBOW (SLIP X SLIP)



Used to change direction in piping. Fitting reduces to smaller pipe size.

Part #	Size	Pkg Qty	Box Qty	Box Wt
30775	¾" x ½"	10	100	8
30716	1" x ½"		50	5
30717	1" x ¾"		50	6
30741	1¼" x 1"		25	5
30750	1½" x 1"		25	8

### 90° STREET ELBOW (MIP X FIP)



Adapts standard female pipe threads to standard male pipe threads. PTFE thread tape is recommended for threaded joints.

Part #	Size	Box Qty.	Box Wt
32705	½"	50	5
32707	¾"	50	5
32715	1½"	25	9
32720	2"	10	6

### 90° STREET ELBOW (MIP X FIP)



Adapts to standard female pipe threads to standard male pipe threads. These elbows are made of Marlex. PTFE thread tape is recommended for threaded joints.

Part #	Size	Box Qty	Box Wt
M32705	½"	50	3
M32707	¾"	50	3

### 90° STREET ELBOW (SLIP X MIP)



Used to change direction in piping. Adapts to standard female pipe threads. PTFE thread tape is recommended for threaded joints.

Part #	Size	Box Qty	Box Wt
32805	½"	50	3
32807	¾"	50	4
32810	1"	50	7
32814	1¼"	25	6
32815	1½"	25	7
32820	2"	10	5

**90° STREET ELBOW (SLIP X SPIGOT)**



Used to change direction in piping.

Part #	Size	Pkg Qty	Box Qty	Box Wt
32905	½"		50	3
32907	¾"		50	4
32910	1"	10	50	7
32914	1¼"		25	5
32915	1½"		25	8
32920	2"		10	5

**90° THREADED ELBOW (FIP X FIP)**



Used to change direction in piping. Adapts to standard male pipe threads. PTFE thread tape is recommended for threaded joints.

Part #	Size	Pkg Qty	Box Qty	Box Wt
33705	½"	10	200	16
33707	¾"	10	100	11
33710	1"	10	100	18
33714	1¼"		25	8

**90° FEMALE ELBOW (SLIP X FIP)**



Used to change direction in piping. Adapts from solvent welded line to standard male pipe threads. PTFE thread tape is recommended for threaded joints.

Part #	Size	Pkg Qty	Box Qty	Box Wt
33905	½"	10	300	20
33907	¾"	10	300	25
33910	1"	10	120	17
33914	1¼"	10	120	27
33915	1½"	10	50	16

Part #	Size	Pkg Qty	Box Qty	Box Wt
33920	2"	5	50	25
33990	2½"		10	15
33940	4"		5	10

**REDUCING 90° FEMALE ELBOW (SLIP X FIP)**



Used to change direction in piping. Adapts from solvent welded line to standard male pipe threads. PTFE thread tape is recommended for threaded joints.

Part #	Size	Pkg Qty	Box Qty	Box Wt
34157	½" x ¾"		50	4
34175	¾" x ½"	10	300	22
34115	1" x ½"	10	50	6
34117	1" x ¾"	10	100	13

**90° ELBOW W/FEMALE SIDE INLET (SLIP X SLIP X FIP)**



Commonly used to connect threaded sprinkler risers to underground systems. Fitting reduces to a smaller pipe size. Adapts to standard male pipe threads. PTFE thread tape is recommended for threaded joints.

Part #	Size	Pkg Qty	Box Qty	Box Wt
33105	½"		50	4
33175	¾" x ¾" x ½"	10	50	5
33176	1" x 1" x ½"		25	3

**TEE (SLIP X SLIP X SLIP)**

Used to provide a branch supply line from a main line.

Part #	Size	Pkg Qty	Box Qty	Box Wt
31405	½"	10	300	22
31407	¾"	10	300	31
31410	1"	10	120	19
31414	1¼"	10	120	30
31415	1½"	10	50	19
31420	2"	10	50	27
31450	2½"		10	12
31430	3"		10	16
31440	4"		5	13
31446	6"		4	29

**TEE (SLIP X SLIP X SLIP) CONTRACTOR PACK**

Conveniently packaged in quantities of 10.

Part #	Size	Box Qty	Box Wt
31405CP	½"	25	19
31407CP	¾"	25	24
31410CP	1"	10	16

**REDUCING TEE (SLIP X SLIP X SLIP)**

Used to provide a branch supply line from a main line. Fitting reduces to a smaller pipe size.

Part #	Size	Pkg Qty	Box Qty	Box Wt
31403	½" x ½" x ¾"		50	4
31421	¾" x ½" x ½"		50	5
31471	¾" x ¾" x ½"	10	150	13
31476	¾" x ½" x ¾"		50	5
31406	¾" x ¾" x 1"		50	7
31475	1" x 1" x ½"	10	50	7
31411	1" x ½" x 1"		50	7

Part #	Size	Pkg Qty	Box Qty	Box Wt
31477	1" x 1" x ¾"	10	120	18
31490	1¼" x 1¼" x ½"		25	6
31491	1¼" x 1¼" x ¾"		25	6
31474	1¼" x 1¼" x 1"	10	50	12
31493	1½" x 1½" x ½"		25	6
31494	1½" x 1½" x ¾"		25	7
31495	1½" x 1½" x 1"		25	8
31419	1½" x 1½" x 1¼"		25	8
31433	2" x 2" x ½"		10	4
31434	2" x 2" x ¾"		10	4
31435	2" x 2" x 1"		10	4
31436	2" x 2" x 1¼"		10	4
31472	2" x 2" x 1½"		10	5
31423	3" x 3" x 2"		10	12
31442	4" x 4" x 2"		5	8
31443	6" x 6" x 3"		5	21
31449	6" x 6" x 4"		5	24

**FEMALE TEE (SLIP X SLIP X FIP)**

Solvent welds into main line to provide a threaded branch line of the same size. PTFE thread tape is recommended for threaded joints.

Part #	Size	Pkg Qty	Box Qty	Box Wt
31455	½"	10	300	23
31457	¾"	10	300	30
31458	1"	10	100	19
31454	1¼"		25	8
31451	1½"		25	11
31452	2"		10	8

**REDUCING FEMALE TEE (SLIP X SLIP X FIP)**

Solvent welds into main line to provide a threaded branch line of reduced size. PTFE thread tape is recommended for threaded joints.

Part #	Size	Pkg Qty	Box Qty	Box Wt
31448	½" x ½" x 1/8"		50	4
31481	¾" x ¾" x ½"	10	150	15
31485	1" x 1" x ½"	10	120	18
31487	1" x 1" x ¾"	10	120	19
31460	1¼" x 1" x 1"		25	8
31480	1¼" x 1¼" x ½"		25	6
31488	1¼" x 1¼" x ¾"		25	6
31484	1¼" x 1¼" x 1"		25	7
31469	1½" x 1¼" x ¾"		25	9
31470	1½" x 1¼" x 1"		25	7
31478	1½" x 1½" x ½"		25	7
31479	1½" x 1½" x ¾"		25	6
31489	1½" x 1½" x 1"		25	8
31482	2" x 2" x ½"		10	4
31496	2" x 2" x ¾"		10	4
31497	2" x 2" x 1"		10	4
31499	2" x 2" x 1½"		10	6

**FEMALE TEE (FIP X FIP X FIP)**

Adapts to male threaded main line to provide a threaded branch line of the same size. PTFE thread tape is recommended for threaded joints.

Part #	Size	Pkg QTY	Box Qty	Box Wt
35455	½"	10	100	9
35457	¾"	10	100	13
35458	1"	10	100	22

**CROSS (ALL SLIP)**

Used to connect like size lateral piping.

Part #	Size	Pkg Qty	Box Qty	Box Wt
34405	½"	10	50	5
34407	¾"	10	50	6
34410	1"	10	50	10
34414	1¼"		25	9
34415	1½"		25	12
34420	2"		10	7
34430	3"		10	19
34440	4"		5	15

**UNION (SLIP X SLIP)**

This union solvent welds directly to PVC pipe and provides a method for future disassembly of piping without cutting.

Working Pressure: 150 PSI @ 73°

Part #	Size	Pkg Qty	Box Qty.	Box Wt
37205	½"	10	20	3
37207	¾"	10	20	6
37210	1"		10	4
37214	1¼"	5	10	8
37215	1½"	5	10	6
37220	2"	5	10	9

**UNION (FIP X FIP)**

This union joins to male threaded pipe and provides a method for future disassembly of piping without cutting. PTFE thread tape is recommended for threaded joints.

Working Pressure: 150 PSI @ 73°

Part #	Size	Box Qty	Box Wt
37505	½"	12	3
37507	¾"	12	4
37510	1"	12	5
37514	1¼"	6	3
37515	1½"	6	4
37520	2"	6	8

**COMPRESSION COUPLING (COMP. X COMP.)**

Commonly referred to as a "dresser coupling" this fitting is used to join two pieces of PVC or other iron pipe sized pipe in cold water applications. Most often used for in-line repairs.

Part #	Size	Box Qty	Box Wt
37105	½"	20	6
37107	¾"	20	7
37110	1"	20	9
37114	1¼"	10	7
37115	1½"	10	9
37120	2"	10	12

**COMPRESSION TEE W/FIP BRANCH**

(COMP. X COMP. X FIP)



Provides a threaded branch line from a main line. Adapts PVC pipe or other iron pipe sized pipe to male pipe threads in cold water applications. PTFE thread tape is recommended for threaded joints.

Part #	Size	Box Qty	Box Wt
37705	½"	24	7
37707	¾"	12	5
37710	1"	12	7

**RISER EXTENDER (FIP X MIP)**

Used to extend sprinkler risers. May be used in initial installation or for replacement purposes. PTFE thread tape is recommended for threaded joints.

Part #	Size	Box Qty	Box Wt
34505	½"	50	3
34507	¾"	50	3

**BALL VALVE t**

These ball valves are made out of PVC for corrosion resistance. Used anywhere a full flow valve is required, such as swimming pools, irrigation systems or agricultural applications. Working Pressure: 150 PSI @ 73°

Part #	Size	Box Qty	Box Wt
37305	½"	10	2
37307	¾"	10	4
37310	1"	10	5
37314	1¼"	10	7
37315	1½"	4	4
37320	2"	4	7

**BALL VALVE (FIP X FIP)**



These ball valves are made out of PVC for corrosion resistance. Used anywhere a full flow valve is required, such as swimming pools, irrigation systems or agricultural applications. Adapts to standard male pipe threads. PTFE thread tape is recommended for threaded joints. Working Pressure: 150 PSI @ 73°

Part #	Size	Box Qty	Box Wt
37405	1/2"	10	2
37407	3/4"	10	4
37410	1"	10	6
37414	1 1/4"	10	7
37415	1 1/2"	4	4
37420	2"	4	7

**GLOBE VALVE (SLIP X SLIP)**



This valve employs the globe valve principle, for use in cold water systems only.

Part #	Size	Box Qty	Box Wt
37805	1/2"	12	3
37807	3/4"	12	3

**RUNNING TRAP (SPIGOT X SPIGOT)**



Used for common air conditioner condensation drains in a horizontal application.

Part #	Size	Pkg Qty	Box Qty	Box Wt
38007	3/4"	10	120	27

**P-TRAP (SPIGOT X SPIGOT)**



Used for common air conditioner condensation drains in a vertical application.

Part #	Size	Pkg Qty	Box Qty	Box Wt
38507	3/4"	10	120	27

**POLYETHYLENE CUTOFF NIPPLE**



Used to connect to sprinkler head, enabling the length to be determined at installation. PTFE thread tape is recommended for threaded joints.

Part #	Size	Pkg Qty	Box Qty	Box Wt
357605	1/2" x 6"	10	50	2
357607	3/4" x 6"	10	50	3
357675	1/2" x 3/4" x 6"	10	100	7

**BULKHEAD FITTING**



Polypropylene Bulkhead Fitting helps to permit the free flow of liquids for tank or drum drainage or filling. Includes EPDM washer. For use with tanks having a wall thickness of 1/16" to 1/2".

Part #	Size	Box Qty	Box Wt
38805	1/2"	20	4
38807	3/4"	20	4
38810	1"	10	4
38814	1 1/4"	10	4
38815	1 1/2"	5	4
38820	2"	5	3

**PVC PRESSURE PIPE (SCH.80)**  
(Cold Water Use Only)



Part #	Size			Pressure Rating at 73°F (PSI)	Bdl. Qty (lgths)	Box Qty (lgths)	Bdl Wt (lbs)
300055	½" x 20'	(Sch. 80)	Plain End	850	10	240	41
300075	¾" x 20'	(Sch. 80)	Plain End	690	10	200	56
300105	1" x 20'	(Sch. 80)	Plain End	630	10	240	83
300115	1¼" x 20'	(Sch.80)	Plain End	520	5	180	57
300125	1½" x 20'	(Sch.80)	Plain End	470	5	200	69
300225	2" x 20'	(Sch. 80)	Plain End	400	5	150	96

**COUPLING (SLIP X SLIP)**



Used to join lengths of pipe.

Part #	Size	Box Qty	Box Wt
301058	½"	25	2
301078	¾"	25	2
301108	1"	25	4
301148	1¼"	10	2
301158	1½"	10	3
301208	2"	10	4

**COUPLING (FIP X FIP)**



Used to join lengths of pipe.

Part #	Size	Box Qty	Box Wt
301258	½"	25	2
301278	¾"	25	3
301288	1"	25	5
301248	1¼"	10	3
301218	1½"	10	4
301228	2"	10	5

**CAP (SLIP)**



Used to cap pipe.

Part #	Size	Box Qty	Box Wt
301558	½"	25	2
301578	¾"	25	3
301588	1"	25	5
301598	1¼"	10	2
301518	1½"	10	3
301528	2"	10	4

**CAP (FIP)**



Used to cap threaded pipe. Adapts to standard male pipe threads. PTFE thread tape is recommended for threaded joints.

Part #	Size	Box Qty	Box Wt
301658	½"	25	2
301678	¾"	25	2
301688	1"	25	3

**PLUG (MIP)**

Adapts to standard female pipe threads. PTFE thread tape is recommended for threaded joints.

Part #	Size	Box Qty	Box Wt
318058	½"	25	1
318078	¾"	25	1
318108	1"	25	2
318148	1¼"	10	1
318158	1½"	10	1
318208	2"	10	2

**REDUCING BUSHING (SPIGOT X SLIP)**

Inserts into fitting hub to reduce to smaller pipe size.

Part #	Size	Box Qty	Box Wt
302518	½" x ¼"	25	1
302758	¾" x ½"	25	1
302158	1" x ½"	25	2
302178	1" x ¾"	25	1
302458	1¼" x ½"	10	2
302478	1¼" x ¾"	10	2
302408	1¼" x 1"	10	1
302558	1½" x ½"	10	2
302578	1½" x ¾"	10	2
302508	1½" x 1"	10	2
302548	1½" x 1¼"	10	1
302258	2" x ½"	10	3
302278	2" x ¾"	10	3
302208	2" x 1"	10	3
302248	2" x 1¼"	10	3
302218	2" x 1½"	10	2

**REDUCING BUSHING (MIP X FIP)**

Inserts into threaded fitting socket to reduce to smaller threaded opening. PTFE thread tape is recommended for threaded joints.

Part #	Size	Box Qty	Box Wt
343758	¾" x ½"	25	1
343158	1" x ½"	25	3
343178	1" x ¾"	25	2
343508	1½" x 1"	10	2
343208	2" x 1"	10	2
343218	2" x 1½"	10	2

**REDUCING BUSHING (SPIGOT X FIP)**

Inserts into fitting hub to reduce to smaller pipe size. PTFE thread tape is recommended for threaded joints.

Part #	Size	Box Qty	Box Wt
342758	¾" x ½"	25	1
342158	1" x ½"	25	2
342178	1" x ¾"	25	1
342478	1¼" x ¾"	10	1
342408	1¼" x 1"	10	1
342558	1½" x ½"	10	2
342578	1½" x ¾"	10	2
342508	1½" x 1"	10	2
342548	1½" x 1¼"	10	1
342258	2" x ½"	10	2
342278	2" x ¾"	10	3
342208	2" x 1"	10	3
342248	2" x 1¼"	10	3
342218	2" x 1½"	10	2

**MALE ADAPTER (SLIP X MIP)**

Adapts pressure pipe to standard female pipe threads. PTFE thread tape is recommended for threaded joints.

Part #	Size	Box Qty	Box Wt
304058	½"	25	1
304078	¾"	25	2
304108	1"	25	3
304148	1¼"	10	2
304158	1½"	10	3
304208	2"	10	3

**FEMALE ADAPTER (SLIP X FIP)**

Adapts pressure pipe to standard male pipe threads. PTFE thread tape is recommended for threaded joints.

Part #	Size	Box Qty	Box Wt
303058	½"	25	2
303078	¾"	25	3
303108	1"	25	5
303148	1¼"	10	3
303158	1½"	10	4
303208	2"	10	5

**45° ELBOW (SLIP X SLIP)**

Used to change direction in piping.

Part #	Size	Box Qty	Box Wt
306058	½"	25	3
306078	¾"	25	3
306108	1"	25	5
306148	1¼"	10	2
306158	1½"	10	4
306208	2"	10	6

**90° ELBOW (SLIP X SLIP)**

Used to change direction in piping.

Part #	Size	Box Qty	Box Wt
307058	½"	25	2
307078	¾"	25	3
307108	1"	25	5
307148	1¼"	10	3
307158	1½"	10	4
307208	2"	10	7

**90° ELBOW (SLIP X FIP)**

Used to change direction in piping. PTFE thread tape is recommended for threaded joints.

Part #	Size	Box Qty	Box Wt
339058	½"	25	3
339078	¾"	25	4
339108	1"	25	6
339148	1¼"	10	4
339158	1½"	10	6
339208	2"	10	8

**90° ELBOW (FIP X FIP)**



Used to change direction in piping. PTFE thread tape is recommended for threaded joints.

Part #	Size	Box Qty	Box Wt
337058	1/2"	25	3
337078	3/4"	25	5
337108	1"	25	6
337148	1 1/4"	10	4
337158	1 1/2"	10	5
337208	2"	10	8

**TEE (SLIP X SLIP X SLIP)**



Used to provide a branch supply line from a main line.

Part #	Size	Box Qty	Box Wt
314058	1/2"	25	3
314078	3/4"	25	3
314108	1"	25	8
314148	1 1/4"	10	4
314158	1 1/2"	10	5
314208	2"	10	7

**TEE (FIP X FIP X FIP)**



Adapts to male threaded main line to provide a threaded branch line of the same size. PTFE thread tape is recommended for threaded joints.

Part #	Size	Box Qty.	Box Wt
354558	1/2"	25	4
354578	3/4"	25	5
354588	1"	25	8
354548	1 1/4"	10	5
354518	1 1/2"	10	7
354528	2"	10	9

**UNION (SLIP X SLIP)**



This union solvent welds directly to PVC pipe and provides a method for future disassembly of piping without cutting. Working Pressure: 150 PSI @ 73°

Part #	Size	Box Qty	Box Wt
372058	1/2"	10	3
372078	3/4"	10	4
372108	1"	10	6
372148	1 1/4"	5	3
372158	1 1/2"	5	7
372208	2"	5	9



# PLASTIC & STEEL INSERT FITTINGS

Insert fittings are used with polyethylene (PE) pipe in buried cold water applications only, such as irrigation, residential lawn sprinkler systems, water service pipe, and swimming pool installations.



## Plastic Insert Fittings

- Meets ASTM D2609
- NSF Listed (except class rated pipe)

## NSF Approved PE Pipe

- Meets ASTM D2239
- Meets PE 3408
- 100, 125, 160 and 200 PSI ratings

## Non-NSF PE Pipe

- Do not use on potable water systems!

(Polyethylene Pipe (900 Series) found on page #94)

- Insert fittings join to PE pipe with stainless steel clamps.
- MIP = Male Iron Pipe Threads; FIP = Female Iron Pipe Threads
- Insert Fitting Materials
  - Polypropylene & PVC (350 & 380 Series)
  - Nylon (360 Series)
  - Galvanized (370 Series)

Phone: 1-800-521-7488 or (810) 744-4500  
 Fax: (810) 744-3130  
 Email: [inquiry@genovaproducts.com](mailto:inquiry@genovaproducts.com)  
 Hours: 8 AM to 5 PM EST Monday - Friday

**INSERT COUPLING (INSERT X INSERT)**

Used to join polyethylene tubing.

Part #	Size	Pkg Qty	Box Qty	Box Wt
350105	½"	10	500	9
350107	¾"	10	400	10
350110	1"	10	200	11
350114	1¼"	10	150	10
350115	1½"	10	50	5
350120	2"	5	50	7

**INSERT COUPLING (INSERT X INSERT) CONTRACTOR PACK**

Conveniently packaged in quantities of 10.

Part #	Size	Box Qty	Box Wt
C350105	½"	50	9
C350107	¾"	40	10
C350110	1"	20	11

**INSERT REDUCING COUPLING (INSERT X INSERT)**

Used to reduce to different polyethylene tubing sizes.

Part #	Size	Pkg Qty	Box Qty	Box Wt
350175	¾" x ½"	25	200	6
350116	1" x ½"	20	300	11
350117	1" x ¾"	10	300	11
380147	1¼" x ¾"		20	2
350140	1¼" x 1"	10	100	6
350157	1½" x ¾"	10	50	4
350150	1½" x 1"	10	50	4
350154	1½" x 1¼"	5	50	5
350220	2" x 1"	5	50	5
350124	2" x 1¼"	5	50	6
350121	2" x 1½"	5	50	6

**INSERT FEMALE ADAPTER (INSERT X FIP)**

Adapts polyethylene tubing to standard male pipe threads. PTFE thread tape is recommended for threaded joints.

Part #	Size	Pkg Qty	Box Qty	Box Wt
350305	½"	10	200	6
350307	¾"	10	400	16
350310	1"	10	120	7
350314	1¼"	10	200	18
350315	1½"	5	50	6
350320	2"	5	50	8

**INSERT MALE ADAPTER (INSERT X MIP)**

Adapts polyethylene tubing to standard female pipe threads. PTFE thread tape is recommended for threaded joints.

Part #	Size	Pkg Qty	Box Qty	Box Wt
350405	½"	10	500	11
350407	¾"	10	300	11
350410	1"	10	200	10
350414	1¼"	10	150	11
350415	1½"	10	50	6
350420	2"	5	50	3

**INSERT REDUCING MALE ADAPTER (INSERT X MIP)**

Adapts polyethylene tubing to standard female pipe threads. Fitting reduces to smaller tubing sizes. PTFE thread tape is recommended for threaded joints.

Part #	Size	Pkg Qty	Box Qty	Box Wt
350475	½" x ¾"	25	350	11
380457	¾" x ½"		50	2
350417	¾" x 1"	20	200	9
380447	¾" x 1¼"		25	3
380451	1" x ½"		50	3

Part #	Size	Pkg Qty	Box Qty	Box Wt
350477	1" x ¾"	20	200	8
350440	1" x 1¼"	10	100	8
350450	1" x 1½"	10	80	9
380404	1¼" x 1"		15	2
350454	1¼" x 1½"	10	80	10
350455	1½" x 1"	10	50	2
380445	1½" x 1¼"		10	2
350421	1½" x 2"	10	50	8

### INSERT PLUG (INSERT)



Used to form permanent closure.

Part #	Size	Pkg Qty	Box Qty	Box Wt
351825	½"	10	300	3
351827	¾"	10	250	5
351830	1"	10	200	5
351834	1¼"	10	200	8
351835	1½"	10	50	3
351840	2"	5	50	5

### INSERT ELBOW (INSERT X INSERT)



Used to change direction in piping.

Part #	Size	Pkg Qty	Box Qty	Box Wt
350705	½"	20	400	10
350707	¾"	10	300	11
350710	1"	10	40	3
350714	1¼"	10	40	4
350715	1½"	5	50	7
350720	2"	5	40	11

### INSERT ELBOW (INSERT X INSERT) CONTRACTOR PACK



Conveniently packaged in quantities of 10.

Part #	Size	Box Qty	Box Wt
C350705	½"	50	14
C350707	¾"	30	12
C350710	1"	20	15

### INSERT REDUCING ELBOW

(INSERT X INSERT)



Used to change direction. Fitting reduces to smaller tubing sizes.

Part #	Size	Pkg Qty	Box Qty	Box Wt
350775	¾" x ½"	20	300	13
350717	1" x ¾"	10	40	3
350740	1¼" x 1"	10	50	7
350754	1½" x 1¼"	10	40	7

### INSERT COMBINATION ELBOW

(INSERT X MIP)



Used to change direction. Adapts to standard female pipe threads. PTFE thread tape is recommended for threaded joints.

Part #	Size	Pkg Qty	Box Qty	Box Wt
352805	½"	10	400	11
352807	¾"	10	200	9
352810	1"	10	100	9
352814	1¼"	10	80	12
352815	1½"	5	50	10
352820	2"	5	40	11

**INSERT COMBINATION ELBOW**

(INSERT X FIP)



Used to change direction. Adapts to standard male pipe threads. PTFE thread tape is recommended for threaded joints.

Part #	Size	Pkg Qty	Box Qty	Box Wt
353905	½"	10	200	9
353907	¾"	10	200	12
353910	1"	10	40	4
353914	1¼"	10	40	6
353915	1½"	5	50	11
353920	2"	5	30	10

**INSERT REDUCING COMBINATION ELBOW**

(INSERT X FIP)



Used to change direction. Adapts to standard male pipe threads. Fitting reduces to smaller tubing size. PTFE thread tape is recommended for threaded joints.

Part #	Size	Pkg Qty	Box Qty	Box Wt
354175	¾" x ½"	10	300	12
354115	1" x ½"	10	80	6
354117	1" x ¾"	10	80	6
384145	1¼" x ½"		25	3
384147	1¼" x ¾"		10	2
354140	1¼" x 1"	10	40	7

**INSERT TEE (INSERT X INSERT X INSERT)**

Used to provide a branch supply line from a main line.

Part #	Size	Pkg Qty	Box Qty	Box Wt
351405	½"	10	260	10
351407	¾"	10	300	16
351410	1"	10	100	8

Part #	Size	Pkg Qty	Box Qty	Box Wt
351414	1¼"	10	100	18
351415	1½"	5	40	11
351420	2"	5	25	10

**INSERT TEE (INSERT X INSERT X INSERT)  
CONTRACTOR PACK**

Conveniently packaged in quantities of 10.

Part #	Size	Box Qty	Box Wt
C351405	½"	30	11
C351407	¾"	25	14
C351410	1"	20	17

**INSERT REDUCING TEE**

(INSERT X INSERT X INSERT)



Used to provide a branch supply line from a main line. Fitting reduces to smaller tubing size.

Part #	Size	Pkg Qty	Box Qty	Box Wt
351421	¾" x ½" x ½"	20	300	17
351471	¾" x ¾" x ½"	10	300	19
351475	1" x 1" x ½"	10	100	10
351477	1" x 1" x ¾"	10	100	10
351428	1¼" x 1" x ¾"	10	100	17
351490	1¼" x 1¼" x ½"	10	100	18
351491	1¼" x 1¼" x ¾"	10	100	18
351474	1¼" x 1¼" x 1"	10	100	18
381419	1½" x 1½" x 1¼"		5	2
381472	2" x 2" x 1½"		5	2

### INSERT COMBINATION TEE

(INSERT X INSERT X MIP)



Used to provide a branch supply line from a main line. Branch line adapts to standard female pipe threads. PTFE thread tape is recommended for threaded joints.

Part #	Size	Pkg Qty	Box Qty	Box Wt
351445	1/2"	20	240	11
351447	3/4"	10	300	19
351440	1"	10	100	11
351441	1 1/2"	5	40	11

### INSERT COMBINATION TEE

(INSERT X INSERT X FIP)



Used to provide a branch supply line from a main line. Branch line adapts to standard male pipe threads. PTFE thread tape is recommended for threaded joints.

Part #	Size	Pkg Qty	Box Qty	Box Wt
351455	1/2"	10	200	11
351457	3/4"	10	300	23
351458	1"	10	100	11
351454	1 1/4"	10	100	20
351451	1 1/2"	5	40	12
351452	2"	5	25	12

### INSERT REDUCING COMBINATION TEE

(INSERT X INSERT X FIP)



Used to provide a branch supply line from a main line. Branch line adapts to standard male pipe threads. Fitting reduces to smaller tubing size. PTFE thread tape is recommended for threaded joints.

Part #	Size	Pkg Qty	Box Qty	Box Wt
351481	3/4" x 3/4" x 1/2"	10	200	10
351485	1" x 1" x 1/2"	10	100	8
351487	1" x 1" x 3/4"	10	100	11
351483	1 1/4" x 1 1/4" x 1/2"	10	100	18
351488	1 1/4" x 1 1/4" x 3/4"	10	100	17
351484	1 1/4" x 1 1/4" x 1"	10	100	16
381482	1 1/2" x 1 1/2" x 1/2"		5	2
381486	1 1/2" x 1 1/2" x 3/4"		5	2

### INSERT CROSS (ALL INSERT)



Used to connect like size lateral tubing.

Part #	Size	Pkg Qty	Box Qty	Box Wt
354407	3/4"	10	200	21
354410	1"	10	100	16

### POLYETHYLENE CUTOFF NIPPLE



Used to connect to sprinkler head, enabling the length to be determined at installation. PTFE thread tape is recommended for threaded joints.

Part #	Size	Pkg Qty	Box Qty	Box Wt
357605	1/2" x 6"	10	50	2
357607	3/4" x 6"	10	50	3
357675	1/2" x 3/4" x 6"	10	100	7

### NYLON INSERT COUPLING

(INSERT X INSERT)



Used to join polyethylene tubing.

Part #	Size	Pkg Qty	Box Qty	Box Wt
360105	½"	25	500	12
360107	¾"	25	400	12
360110	1"	25	200	13
360114	1¼"	10	150	12
360115	1½"	10	50	6
360120	2"	5	50	9

### NYLON INSERT MALE ADAPTER

(INSERT X MIP)



Adapts polyethylene tubing to standard female pipe threads. PTFE thread tape is recommended for threaded joints.

Part #	Size	Pkg Qty	Box Qty	Box Wt
360405	½"	25	500	15
360407	¾"	25	300	13
360410	1"	25	200	12
360414	1¼"	10	150	13
360415	1½"	10	50	7
360420	2"	5	50	10

### NYLON INSERT ELBOW (INSERT X INSERT)



Used to change direction in piping.

Part #	Size	Pkg Qty	Box Qty	Box Wt
360705	½"	20	400	12
360707	¾"	20	300	14
360710	1"	10	40	5
360714	1¼"	10	40	5
360715	1½"	5	50	9
360720	2"	5	40	14

### NYLON INSERT TEE

(INSERT X INSERT X INSERT)



Used to provide a branch supply line from a main line.

Part #	Size	Pkg Qty	Box Qty.	Box Wt
361405	½"	20	260	12
361407	¾"	20	300	20
361410	1"	10	100	14
361414	1¼"	10	100	22
361415	1½"	5	40	13
361420	2"	5	25	12

### NYLON INSERT COMBINATION ELBOW

(INSERT X MIP)



Used to change direction. Adapts to standard female pipe threads. PTFE thread tape is recommended for threaded joints.

Part #	Size	Pkg Qty	Box Qty	Box Wt
362805	½"	20	400	13
362807	¾"	20	200	11
362810	1"	10	100	10
362814	1¼"	10	80	14
362815	1½"	5	50	12

**STEEL INSERT COUPLING (INSERT X INSERT)**

Used to join polyethylene tubing.

Part #	Size	Box Qty	Box Wt
370105	1/2"	100	12
370107	3/4"	100	24
370110	1"	100	45
370114	1 1/4"	20	11
370115	1 1/2"	20	14
370120	2"	10	12

**STEEL INSERT MALE ADAPTER**

(INSERT X MIP)



Adapts polyethylene tubing to standard female pipe threads. PTFE thread tape is recommended for threaded joints.

Part #	Size	Box Qty	Box Wt
370405	1/2"	25	4
370407	3/4"	25	6
370410	1"	20	8
370414	1 1/4"	20	11
370415	1 1/2"	20	15
370420	2"	10	11



# PVC SEWER FITTINGS

Sewer & Drain and fittings are used for sewer lines, septic tank seepage systems and perimeter drains.



## Solid & Perforated PVC Sewer Pipe

- 3" & 4" meets ASTM D2729
- 4" & 6" SDR 35 meets ASTM D3034
- Pipe measures 10' before bell

## PVC Sewer Fittings

- 3" meets ASTM D2949 or exceeds ASTM D2729
- 4" & 6" meets ASTM D3034

## Corrugated Sewer Fitting

- Meets ASTM F405

- Sewer pipe sizes are sometimes referred to as PSM (Plastic Sewer Main).
- Solvent weld joints on PVC.
- HDPE Corrugated fittings snap together. Use with HDPE Corrugated pipe.

Phone: 1-800-521-7488 or (810) 744-4500  
 Fax: (810) 744-3130  
 Email: [inquiry@genovaproducts.com](mailto:inquiry@genovaproducts.com)  
 Hours: 8 AM to 5 PM EST Monday - Friday

[genovaproducts.com](http://genovaproducts.com)

**VINYL SEWER AND DRAIN PIPE**

(10' BELL END)



An integral hub is provided on each length of sewer and drain pipe to facilitate easy joining without the need for additional couplings. Pipe is perforated with 2 rows of 5/8" holes on 5" centers 120° apart. 3" Pipe is perforated with 2 rows of 1/2" holes on 5" centers 120° apart.

\*This pipe perforated with 3 rows of 3/4" holes on 5" centers 120° apart. Meets Indiana code.

Note: Be sure to order by the length.

Part #	Size	ASTM Standard	Bdl Qty	Skid Qty	Bdl Wt
40030	3" Solid	D2729	5	75	25
40031	3" Perf.	D2729	5	75	25
40040	4" Solid	D2729	5	120	30
40041	4" Perf.	D2729	5	120	30
40041I*	4" Perf.	D2729	5	120	30
40066	6" Solid	D2729		24	310
40050	4" Solid	D3034	5	80	51
40051	4" Perf.	D3034	5	80	51
40060	6" Solid	D3034		24	558

**COUPLING (HUB X HUB)**

Used to join straight lengths of pipe.

Part #	Size	Pkg. Qty	Box Qty	Box Wt
40130	3"		20	6
40140	4"	10	50	22
40160	6"		5	8

**REDUCING COUPLING**

(SEWER HUB X SEWER HUB)



Used to increase or reduce pipe sizes.

Part #	Size	Box Qty	Box Wt
40143	4" x 3"	20	9
41540	6" x 4"	10	13

**ADAPTER COUPLING**

(SEWER HUB X PVC-DWV HUB)



Used to join straight lengths of pipe.

Part #	Size	Box Qty	Box Wt
40131	3" x 1 1/2"	20	7
40132	3" x 2"	20	6
41534	3" x 4"	20	16
41543	4" x 3"	20	12
41544	4" x 4"	10	7
41564	6" x 4"	5	7

**CAP (HUB)**

Used to permanently or temporarily cap pipe.

Part #	Size	Box Qty	Box Wt
40153	3"	20	4
40154	4"	10	4
40156	6"	5	6

### REDUCING BUSHING

(SEWER SPIGOT X SEWER HUB)



Inserts into fitting hub to reduce to smaller pipe size.

Part #	Size	Box Qty	Box Wt
40264	6" x 4"	5	6

### ADAPTER BUSHING

(SEWER SPIGOT X PVC-DWV HUB)



Adapts a sewer and drain fitting hub to Schedule 40 IPS (700 Series pipe size).

Part #	Size	Box Qty	Box Wt
40231	3" x 1½"	20	7
40232	3" x 2"	20	8
40241	4" x 1½"	10	3
40242	4" x 2"	10	4

### ADAPTER BUSHING

(SEWER SPIGOT X FIP)



Inserts into fitting hub to reduce to standard male pipe threads. PTFE thread tape is recommended for threaded joints.

Part #	Size	Box Qty	Box Wt
44241	4" x 1½"	10	3

### ADAPTER BUSHING

(PVC-DWV SPIGOT X SEWER HUB)



Adapts a Schedule 40 IPS fitting hub to sewer pipe.

Part #	Size	Box Qty	Box Wt
45330	3" x 3"	20	3

### FEMALE ADAPTER (HUB X FIP)



Adapts sewer pipe to standard male pipe threads. PTFE thread tape is recommended for threaded joints.

Part #	Size	Box Qty	Box Wt
40330	3"	20	10
40340	4"	10	7
40360	6"	5	6

### MALE ADAPTER (HUB X MIP)



Adapts sewer pipe to standard female pipe threads. PTFE thread tape is recommended for threaded joints.

Part #	Size	Box Qty	Box Wt
40430	3"	20	7

**VINYL TO CLAY ADAPTER (HUB X HUB)**

Used to connect vinyl sewer pipe to clay tile.

Part #	Size	Box Qty	Box Wt
41540	4"	10	13

**SEWER PIPE TO CAST IRON BUSHING**

(HUB X SPIGOT)



Part #	Size	Box Qty	Box Wt
40540	4"	10	4

**SEWER PIPE TO CAST IRON ADAPTER**

(HUB X HUB)



Can be joined to cast iron with oakum and poured lead or lead substitute.

Part #	Size	Box Qty	Box Wt
41740	4"	10	8

**22½° ELBOW (HUB X HUB)**

Used to change direction in piping. Sometimes called a "Sixteenth Bend".

Part #	Size	Box Qty	Box Wt
40830	3"	20	10
40840	4"	10	7
40860	6"	5	10

**45° ELBOW (HUB X HUB)**

Used to change direction in piping. Sometimes called an "Eighth Bend".

Part #	Size	Box Qty	Box Wt
40630	3"	20	10
40640	4"	10	8
40660	6"	5	12

**45° STREET ELBOW (HUB X SPIGOT)**

Used to change direction in piping. Sometimes called a "Street Eighth Bend".

Part #	Size	Box Qty	Box Wt
42730	3"	20	9
42740	4"	10	8
42760	6"	5	12

**90° SANITARY ELBOW (HUB X HUB)**

Used to change direction in piping. Sometimes called a "Quarter Bend".

Part #	Size	Box Qty	Box Wt
42830	3"	20	14
42840	4"	10	11
42860	6"	8	23

**90° SANITARY STREET ELBOW**

(HUB X SPIGOT)



Used to change direction in piping. Sometimes called a "Street Quarter Bend".

Part #	Size	Box Qty	Box Wt
42936	3"	20	14
42940	4"	10	11

**90° SHORT TURN STREET ELBOW**

(HUB X SPIGOT)



Used to change direction in piping. Sometimes called a "Street Quarter Bend".

Part #	Size	Box Qty	Box Wt
42946	4"	10	8
42966	6"	5	15

**90° SHORT TURN ELBOW (HUB X HUB)**



Used to change direction in piping. Sometimes called a "Short Turn Quarter Bend".

Part #	Size	Box Qty	Box Wt
40730	3"	20	10
40740	4"	10	9
40760	6"	5	16

**WYE (HUB X HUB X HUB)**



Used to connect horizontal branch line to straight sewer line. Also, used with cleanout to provide access to piping.

Part #	Size	Box Qty	Box Wt
41030	3"	20	19
41040	4"	10	16
41060	6"	6	28
41064	6" x 6" x 4"	5	22

**SANITARY TEE (HUB X HUB X HUB)**

Used to connect vertical branch line to straight sewer line. Also, used with cleanout to provide access to piping.

Part #	Size	Box Qty	Box Wt
41130	3"	20	22
41140	4"	10	14
41160	6"	6	23

**BULL NOSE TEE (HUB X HUB X HUB)**

Used primarily in seepage bed piping grids in conjunction with perforated pipe. Used where flow characteristics are not a primary consideration.

Part #	Size	Box Qty	Box Wt
41430	3"	10	8
41440	4"	10	11
41460	6"	5	19
41464	6" x 6" x 4"	6	21

**TWO-WAY CLEANOUT (HUB X HUB X HUB)**

Used with a vertical pipe stack, this fitting provides for above ground level access to piping.

Part #	Size	Box Qty	Box Wt
41644	4"	10	16

**FITTING CLEANOUT BODY (SPIGOT X FIP)**

Solvent welds into fitting hub and adapts to male threaded plug. PTFE thread tape is recommended for threaded joints.

Part #	Size	Box Qty	Box Wt
41629	3"	20	7
41639	4"	10	4
41659	6"	5	6

**FITTING CLEANOUT W/THREADED PLUG**

Solvent welds into fitting hub to provide access to piping. PTFE thread tape is recommended for threaded joints.

Part #	Size	Box Qty	Box Wt
41640	4"	10	8

**PLUG (MIP)**

Used to form a removable closure. PTFE thread tape is recommended for threaded joints.

Part #	Size	Box Qty	Box Wt
41830	3"	20	4
41840	4"	10	3
41860	6"	5	4

**CROSS (ALL HUB)**



Used to connect two branch lines approaching a main sewer pipe from opposing directions. Used primarily in seepage bed grid in conjunction with perforated pipe.

Part #	Size	Box Qty	Box Wt
43240	4"	10	23

**SADDLE (STREET/SOCKET DESIGN)**



Solvent welds directly to side of sewer pipe to provide a simple way of connecting a branch into a drain pipe. The inlet is constructed to accept a 2" fitting over its outside diameter or a 1½" pipe into its inside diameter.

Part #	Size	Box Qty	Box Wt
41241	4" x 1½"/2"	10	5

**DOWNSPOUT ADAPTER**

(SEWER HUB OR SCH. 40 SPIGOT)



Used to connect rain gutter downspouts to underground sewer piping.

Part #	Size	Box Qty	Box Wt
45233	2" x 3" x 3"	10	27
45234	2" x 3" x 4"	10	5
45344	3" x 4" x 4"	10	5

**OFFSET DOWNSPOUT ADAPTER**

(SEWER HUB OR SCH. 40 SPIGOT)



Used to connect rain gutter downspouts to underground sewer piping.

Part #	Size	Box Qty	Box Wt
46234	2" x 3" x 4"	10	5
46344	3" x 4" x 4"	10	5

**VINYL "HUB-FIT" FLOOR STRAINER**



Prevents debris from entering a drain opening on the floor. Fits flush into any fitting hub.

Part #	Size	Box Qty	Box Wt
49230	3"	20	5
49240	4"	10	5

**EXTERNAL SNAP COUPLING (HUB X HUB)**

Snaps over pipe to connect two pieces of pipe.

Part #	Size	Box Qty	Box Wt
48030	3"	24	3
48040	4"	20	3
48060	6"	8	3

**INTERNAL SNAP COUPLING****(INSERT X INSERT)**

Snaps inside pipe to connect two pieces of pipe.

Part #	Size	Box Qty	Box Wt
48230	3"	30	3
48240	4"	24	5
48260	6"	8	3

**OFFSET REDUCING COUPLING (HUB X HUB)**

Transitions from one size pipe to another.

Part #	Size	Box Qty	Box Wt
48043	4" x 3"	20	4
48064	6" x 4"	8	3

**CAP (HUB)**

Used to terminate pipe.

Part #	Size	Box Qty	Box Wt
48153	3"	20	2
48154	4"	30	4
48156	6"	10	2

**CORRUGATED TO RIGID ADAPTER****(INSERT X HUB)**

Connects corrugated pipe directly to rigid pipe or to rigid fitting.

Part #	Size	Box Qty	Box Wt
48430	3"	20	2
48440	4"	24	4

**90° ELBOW (HUB X HUB)**

Changes direction in pipe, sometimes called a "Quarter Bend".

Part #	Size	Box Qty	Box Wt
48830	3"	15	4
48840	4"	12	3
48860	6"	4	3

**STRAIGHT TEE (HUB X HUB X HUB)**



Connects lateral or riser pipe to drain line.

Part #	Size	Box Qty	Box Wt
48130	3"	12	3
48140	4"	12	4
48160	6"	4	4

**REDUCING TEE (HUB X HUB X HUB)**



Connects smaller branch pipe to drain line. Cut off branch socket(s) to make 5" or 6" socket.

Part #	Size	Box Qty	Box Wt
48464	6" x 6" x 4"	3	3

**BLIND TEE (HUB X HUB)**



Used as a 90° Elbow. Cut off 6" cap to make a Hub x Hub x Hub Tee. Cut off branch socket(s) to make 5" or 6" socket.

Part #	Size	Box Qty	Box Wt
48560	6'	3	3
48564	6" x 6" x 4"	3	4

**WYE (HUB X HUB X HUB)**



Connects lateral branch pipe to drain line.  
\* Cut off 4" branch socket to make 6" socket.

Part #	Size	Box Qty	Box Wt
48630	3"	10	4
48640	4"	8	4
48660	6"	4	5
48664	6" x 6" x 4"	4	5

**DOWNSPOUT ADAPTER (DS X INSERT)**



Used to transition from rain gutter downspout to corrugated pipe. Snaps inside corrugated pipe.

Part #	Size	Box Qty	Box Wt
48233	2" x 3" x 3"	15	2
48234	2" x 3" x 4"	18	3
48344	3" x 4" x 4"	15	3
48466	4" x 6" x 6"	2	1



# CPVC PIPE & FITTINGS

Chlorinated Polyvinyl Chloride (CPVC) pipe and fittings are used within buildings for potable hot and cold water distribution from the water meter to fixtures.



## CPVC Tubing & Fitting Systems

- Meets ASTM D2846
- Rated for 400 PSI @ 73°F & 100 PSI @ 180°F
- NSF Listed

## No Lead CPVC Fittings

- Product certified to NSF Standard 61, Annex G
- Weighted Average Lead Content Of  $\leq 0.25\%$

- Outside diameters are the same as copper tube. (CTS = Copper Tube Size)
- CPVC systems are accepted by all major model building codes.
- Carded (c) parts contain bar code and installation instructions.
- CPVC tubing is rated at 210° for water heater relief valve drain applications.
- Solvent weld joints.

Phone: 1-800-521-7488 or (810) 744-4500  
 Fax: (810) 744-3130  
 Email: [inquiry@genovaproducts.com](mailto:inquiry@genovaproducts.com)  
 Hours: 8 AM to 5 PM EST Monday - Friday

**CPVC PIPE**

(Note: Be sure to order by the length and not by the foot.)

Part #	Size	Inner Bdl (lgths)	Bdl Qty (lgths)	Skid Qty (lgths)	Bdl Wt (lbs)
50005	1/2" x 10'	10	100	1000	9
50025	1/2" x 5'	10	100	1000	4
50007	3/4" x 10'	10	50	500	15
50035	3/4" x 5'	10	50	500	7
560010	1" x 10'	5		480	12

**COUPLING (SLIP X SLIP)**

Used to join straight lengths of CPVC tubing.

Part #	Size	Pkg Qty	Box Qty	Box Wt
50105	1/2"	20	500	9
50107	3/4"	20	260	9
50110	1"	10	100	7
50114	1 1/4"	10	100	10
50115	1 1/2"	10	50	9
50120	2"	5	25	9

**COUPLING (SLIP X SLIP) CONTRACTOR PACK**

Conveniently packaged in quantities of 10.

Part #	Size	Box Qty	Box Wt
50105CP	1/2"	50	9
50107CP	3/4"	25	8

**REDUCING COUPLING (SLIP X SLIP)**

Used to join straight lengths of CPVC tubing. Reduces to smaller size tubing.

Part #	Size	Pkg Qty	Box Qty	Box Wt
50175	3/4" x 1/2"	10	500	13
50117	1" x 3/4"	10	100	5

**CAP (SLIP)**

Used to permanently or temporarily cap CPVC Tubing.

Part #	Size	Pkg Qty	Box Qty	Box Wt
50155	1/2"	10	500	6
50157	3/4"	10	250	6
50158	1"	10	100	5
50159	1 1/4"	10	100	7
50151	1 1/2"	10	50	6
50152	2"	5	25	6

**REDUCING BUSHING (SPIGOT X SLIP)**



Used to reduce from fitting socket to CPVC tubing.

Part #	Size	Pkg Qty	Box Qty	Box Wt
50275	3/4" x 1/2"	10	500	9
50215	1" x 1/2"	10	100	4
50217	1" x 3/4"	10	100	3
50245	1 1/4" x 1/2"	10	100	6
50247	1 1/4" x 3/4"	10	100	6
50240	1 1/4" x 1"	10	100	5
50257	1 1/2" x 3/4"	10	100	10
50250	1 1/2" x 1"	10	100	9
50254	1 1/2" x 1 1/4"	10	100	7
50227	2" x 3/4"	10	50	9
50220	2" x 1"	10	100	18
50224	2" x 1 1/4"	10	50	10
50221	2" x 1 1/2"	10	50	8

**PVC TO CPVC BUSHING**

(IPS SPIGOT X CTS SLIP)



Used in COLD WATER APPLICATIONS ONLY to adapt from a PVC fitting socket to CPVC tubing.

Part #	Size	Pkg Qty	Box Qty	Box Wt
55305	1/2"	10	200	4
55307	3/4"	10	200	5
55310	1"	10	100	4
55314	1 1/4"	5	25	2
55315	1 1/2"	5	25	2
55320	2"	5	25	3

**SPECIAL FEMALE ADAPTER (SLIP X FIP)**



Used to adapt to male pipe threads to CPVC tubing. A special elastomeric gasket ensures a leakproof seal. Hand-tighten only! This fitting seals by means of a gasket. The use of joint compound or PTFE tape is neither necessary or recommended.

Part #	Size	Pkg Qty	Box Qty	Box Wt
50305	1/2"	20	500	17
50307	3/4"	10	250	11
50310	1"	10	100	9

**MALE ADAPTER (MIP X SLIP)**



Used to adapt female pipe threads to CPVC tubing in COLD WATER APPLICATIONS ONLY! Where hot water or changing water temperatures are likely to be encountered, utilize the recommended TRANSITION UNIONS. PTFE thread tape is the accepted method of sealing pipe threads on CPVC fittings. Do not use other materials or compounds unless specifically approved by the manufacturer.

Part #	Size	Pkg Qty	Box Qty	Box Wt
50405	1/2"	20	500	12
50407	3/4"	10	250	12
50410	1"	10	100	7
50414	1 1/4"	10	50	5
50415	1 1/2"	10	50	8
50420	2"	5	25	9
50475	1/2" x 3/4"	10	250	9

**MALE ADAPTER (MIP X SLIP) CONTRACTOR PACK**

Conveniently packaged in quantities of 10.

Part #	Size	Box Qty	Box Wt
50405CP	1/2"	50	11
50407CP	3/4"	25	12

**RISER ADAPTER (MIP X SLIP)**

Connects to all flexible supply lines and solvent welds onto CPVC pipe.

Part #	Size	Pkg Qty	Box Qty	Box Wt
50455	½"	20	500	14

**PVC TO CPVC ADAPTER (IPS SLIP X CTS SLIP)**

Used in COLD WATER APPLICATIONS ONLY to adapt from CPVC pipe to PVC pipe.

Part #	Size	Pkg Qty	Box Qty	Box Wt
51577	¾"	25	250	9

**45° ELBOW (SLIP X SLIP)**

Used to change direction in piping. Sometimes used in conjunction with a 12" length of CPVC tubing on long runs to absorb expansion.

Part #	Size	Pkg Qty	Box Qty	Box Wt
50605	½"	20	500	11
50607	¾"	20	260	10
50610	1"	10	50	4
50614	1¼"	10	50	6
50615	1½"	10	50	10
50620	2"	5	25	11

**45° STREET ELBOW (SLIP X SPIGOT)**

Used on close offsets where very short pieces of CPVC pipe would otherwise have to be used with conventional 45° elbows. A principal use is to offset piping over and around existing piping mounted on flat surfaces such as wall or ceiling.

Part #	Size	Pkg Qty	Box Qty	Box Wt
52705	½"	20	500	14
52707	¾"	20	260	13

**90° ELBOW (SLIP X SLIP)**

Used to change direction in piping.

Part #	Size	Pkg Qty	Box Qty	Box Wt
50705	½"	20	500	14
50707	¾"	20	260	15
50710	1"	10	100	10
50714	1¼"	10	100	15
50715	1½"	10	50	13
50720	2"	5	25	14

**90° ELBOW (SLIP X SLIP) CONTRACTOR PACK**

Conveniently packaged in quantities of 10.

Part #	Size	Box Qty	Box Wt
50705CP	½"	50	14
50707CP	¾"	25	14

**REDUCING 90° ELBOW (SLIP X SLIP)**

Used to change direction in piping. This elbow can also be used as a 3/4" Street Elbow.

Part #	Size	Pkg Qty	Box Qty	Box Wt
50775	3/4" x 1/2"	10	250	16

**90° STREET ELBOW (SLIP X SPIGOT)**

Used to change direction in piping 90° from a fitting socket. The 3/4" Elbow (Part #52907) can also be used as a 3/4" x 1/2" reducing elbow.

Part #	Size	Pkg Qty	Box Qty	Box Wt
52905	1/2"	10	500	16
52907	3/4"	10	250	16

**TEE (SLIP X SLIP X SLIP)**

Used to provide a branch supply line from a main line.

Part #	Size	Pkg Qty	Box Qty	Box Wt
51405	1/2"	20	500	17
51407	3/4"	20	260	19
51410	1"	10	100	12
51414	1 1/4"	10	50	10
51415	1 1/2"	5	25	8
51420	2"	5	25	17

**TEE (SLIP X SLIP X SLIP) CONTRACTOR PACK**

Conveniently packaged in quantities of 10.

Part #	Size	Box Qty	Box Wt
51405CP	1/2"	50	17
51407CP	3/4"	25	19

**REDUCING TEE (SLIP X SLIP X SLIP)**

Used to provide a branch supply line from a main line. Reduces to a smaller pipe size.

Part #	Size	Pkg Qty	Box Qty	Box Wt
51471	3/4" x 3/4" x 1/2"	20	260	17
51473	3/4" x 1/2" x 1/2"	20	260	14
51476	3/4" x 1/2" x 3/4"	20	260	16
51475	1" x 1" x 1/2"	5	25	3
51477	1" x 1" x 3/4"	5	25	3
51490	1 1/4" x 1 1/4" x 1/2"	5	25	4
51491	1 1/4" x 1 1/4" x 3/4"	5	25	5
51474	1 1/4" x 1 1/4" x 1"	5	25	5
51493	1 1/2" x 1 1/2" x 1/2"	5	25	7
51494	1 1/2" x 1 1/2" x 3/4"	5	25	7
51495	1 1/2" x 1 1/2" x 1"	5	25	8
51419	1 1/2" x 1 1/2" x 1 1/4"	5	25	8
51435	2" x 2" x 1"	5	25	14
51436	2" x 2" x 1 1/4"	5	25	15
51472	2" x 2" x 1 1/2"	5	25	16

**SPECIAL TORQUE ESCUTCHEON**

This special flange is designed to prevent torque change on CPVC pipes exiting through walls to which valves or threaded transition fittings are attached. The "torque flange" is welded to the pipe and fastened to the wall with screws thereby preventing twisting motion being transmitted to concealed joints.

Part #	Size	Pkg Qty	Box Qty	Box Wt
530131	1/2" (C)		10	1
53013	1/2"	10	50	2

**LINE VALVE (SLIP X SLIP)**

This unique valve employs the globe valve principle and is manufactured of high temperature thermoplastics. It is designed to solvent weld to CPVC tubing. This valve employs "Street/Socket" feature which allows it to be used with 1/2", 3/4", and 1" CPVC tubing. (2 - 3/4" couplings are required to attach the valve to 3/4" CPVC tubing. 2 - 1" couplings are required to attach the valve to 1" CPVC tubing).

Part #	Size	Box Qty	Box Wt
530151	3/4" / 1/2" (C)	10	3
53015	3/4" / 1/2"	10	2
530161	3/4" / 1/2" W/WASTE (C)	5	2
53016	3/4" / 1/2" W/WASTE	10	2
53031	1" / 3/4"	10	3
53032	1" / 3/4" W/WASTE	10	3

**BALL VALVES (SLIP X SLIP)**

These ball valves are full flow valves with PTFE seal and quarter turn operation. For use with CPVC pipe.

Part #	Size	Box Qty	Box Wt
57305	1/2"	10	2
57307	3/4"	5	3

**BOILER DRAIN (SLIP X MHT)**

Solvent welds to CPVC pipe for hot and cold water. (3/4" hose threads)

Part #	Size	Box Qty	Box Wt
52028	1/2"	12	3
52029	3/4"	12	3

**BOILER DRAIN (MIP X MHT)**

For use with female threaded fitting pipe in cold or hot water up to 150 PSI @ 180°F. (3/4" hose thread) PTFE thread tape is recommended for threaded joints.

Part #	Size	Box Qty	Box Wt
53028	1/2"	12	2
53029	3/4"	12	2

**HOSE BIBB (MIP X MHT)**

For use with female threaded fitting pipe in cold or hot water up to 150 PSI @ 180°F. (3/4" hose thread) Do not use other material compounds unless approved by the manufacturer. PTFE thread tape is recommended for threaded joints.

Part #	Size	Box Qty	Box Wt
53022	1/2"	12	3
53023	3/4"	12	3

**STRAIGHT VALVE (CPVC X NPSM)**



Solvent welds directly to CPVC tubing and adapts to both metal and plastic Siamese Supply Tubes.

Part #	Size	Pkg Qty	Box Qty	Box Wt
53020	½"	25	100	14

**ANGLE VALVE (SLIP X SLIP)**



The unique valve provides for changing direction in piping as well as providing a controlled line flow.

Part #	Size	Box Qty	Box Wt
53066	½"	10	2

**WASHER HOSE VALVE (SLIP X MHT)**



Solvent welds directly to ½" CPVC tubing and adapts to female hose couplings. Most often used in conjunction with a wing elbow (#53056) to supply water to automatic washing machines.

Part #	Size	Box Qty	Box Wt
530671	½" (C)	10	2
53067	½"	10	2

**SILLCOCK (SLIP X MHT)**



Can be solvent welded directly to ¾" CPVC water supply line or ½" CPVC pipe with a bushing (#50275). Also adapts to copper tubing from CPVC pipe by using Genogrip adapter (#53085).

Part #	Size	Box Qty	Box Wt
530941	¾" (C)	5	2

**WINGED TEE (SLIP X SLIP X SLIP)**



Used on lavatory and sink "rough-ins" instead of conventional tee, providing a more rigid "rough-in" and eliminates the need for tubing hangers. Also provides for rigid mounting of washer valves for automatic washer hose hook-ups at laundry tray.

Part #	Size	Pkg Qty	Box Qty	Box Wt
53058	½"	25	50	2

**WING ELBOW (SLIP X SLIP)**



This elbow is used to change direction in piping and features lugs for fastening. Often used in conjunction with Washer Hose Valve (#530671) for hooking up to automatic clothes washers as well as fabricating water supply piping stub outs for toilet installation. Sometimes called a "Drop Ear" elbow.

Part #	Size	Box Qty	Box Wt
530561	½" (C)	5	1
53056	½"	25	2

**SPECIAL FEMALE WING ELBOW (SLIP X FIP)**

This elbow adapts from ½" CPVC to ½" male metal pipe threads and features lugs for fastening. A special elastomeric gasket ensures a leakproof seal. Used on tub and shower faucets to adapt from the ½" CPVC riser to the chrome shower arm. Sometimes called a "Drop Ear" elbow.

Hand tighten only! This fitting seals by means of a gasket and the use of joint compound or PTFE thread tape is not necessary or recommended.

Part #	Size	Box Qty	Box Wt
530551	½" (C)	10	2
53055	½"	25	2

**HOSE COUPLER (SLIP X FHT)**

Used to adapt male hose threads to CPVC. This fitting seals by means of a gasket and the use of joint compound or PTFE thread tape is neither necessary nor recommended.

Part #	Size	Pkg Qty	Box Qty	Box Wt
53124	¾"	10	50	3

**MALE HOSE ADAPTER (SPIGOT X MHT)**

This adapter solvent welds directly into ½" CPVC fitting socket and adapts to female hose coupling.

Part #	Size	Pkg Qty	Box Qty	Box Wt
53128	½" St. x ¾"	10	400	10

**90° SWIVEL ELBOW (SLIP X FEMALE NPSM)**

Allows a direct 90° connection between CPVC tubing and male running threads on faucet. Has a cone washer inside female end to achieve seal.

Part #	Size	Box Qty	Box Wt
54935	½"	50	3

**90° MALE SWIVEL ELBOW**

(MALE NPSM x FEMALE NPSM)



Provides a 90° change in direction of the male running threads on a faucet. Has a cone washer inside female end to achieve seal.

Part #	Size	Box Qty	Box Wt
54945	½"	50	5

**SWIVEL ADAPTER COUPLING**

(SLIP X FEMALE NPSM)



Allows a direct connection between CPVC tubing and male running threads on faucet. Has a cone washer inside female end to achieve seal.

Part #	Size	Box Qty	Box Wt
54950	½"	50	3

**CPVC TRANSITION ADAPTER (SPIGOT)**

Used in conjunction with a brass compression fitting to transition to a CPVC fitting. Replaces the ferrule.

Part #	Size	Pkg Qty	Box Qty	Box Wt
50465	1/2"	10	250	5
50467	3/4"	10	50	2

**UNION (SLIP X SLIP)**

This union solvent welds directly to CPVC pipe and provides a method for future disassembly of piping without cutting.

Part #	Size	Pkg Qty	Box Qty	Box Wt
530211	1/2" (C)		10	2
53021	1/2"	10	20	3
530261	3/4" (C)		10	3
53026	3/4"		10	2

**TRANSITION UNION (SLIP X BRASS FIP)**

This special fitting is designed to compensate for the difference in coefficients of expansion which exist between CPVC and metal pipe in hot water applications. Solvent welds directly to CPVC tube and adapts to standard male pipe threads. PTFE thread tape is the accepted method of sealing pipe threads on CPVC fittings. Do not use other materials or compounds unless approved by the manufacturer.

Part #	Size	Pkg Qty	Box Qty	Box Wt
53035Z	1/2"	10	20	4
530401Z	3/4" (C)		5	2
53040Z	3/4"		10	3

**TRANSITION UNION (SLIP X BRASS MIP)**

This special fitting is designed to compensate for the difference in coefficients of expansion which exist between CPVC and metal pipe in hot water applications. Solvent welds directly to CPVC tube and adapts to standard female pipe threads. PTFE thread tape is the accepted method of sealing pipe threads on CPVC fittings. Do not use other materials or compounds unless approved by the manufacturer.

Part #	Size	Pkg Qty	Box Qty	Box Wt
53045Z	1/2"	10	20	5
530501Z	3/4" (C)		5	2
53050Z	3/4"		10	4

**TRANSITION UNION (SLIP X BRASS SLIP)**

Used to transition from copper or brass tube to CPVC. Permits easy disassembly of piping system. Remove CPVC component and gasket before making sweat connection.

Part #	Size	Box Qty	Box Wt
53033Z	1/2"	20	3
53043Z	3/4"	20	6

**TRANSITION UNION (SLIP X BRASS COMPRESSION)**

Used to transition from copper or brass tube to CPVC. Permits easy disassembly of piping system. Uses replaceable brass ferrule. Not for use with PEX tubing.

Part #	Size	Box Qty	Box Wt
53034Z	1/2"	20	6
53044Z	3/4"	10	5

**DROP EAR ELBOW (SLIP X BRASS FIP)**

Used to transition from metal male pipe threads to CPVC. Provides for rigid installation by mounting elbow to wall. Usually used for shower arm or washer hose valve installation.

Part #	Size	Box Qty	Box Wt
53071Z	1/2"	20	8

**TRANSITION UNION (SLIP X BRASS FIP)**



Used to transition from metal male pipe threads to CPVC. Permits easy disassembly of piping systems.

Part #	Size	Box Qty	Box Wt
53373Z	1/2"	20	4
53375Z	3/4"	20	8

**TRANSITION UNION (SLIP X BRASS MIP)**



Used to transition from metal female pipe threads to CPVC. Permits easy disassembly of piping systems.

Part #	Size	Box Qty	Box Wt
53374Z	1/2"	20	4
53376Z	3/4"	20	7
53037Z	1/2" x 3/4"	20	5

**1 PIECE DESIGN  
DROP EAR ELBOW (SLIP X BRASS FIP)**



Used to transition from metal male pipe threads to CPVC. Provides for rigid installation by mounting elbow to wall. Usually used for shower arm or washer hose valve installation.

Part #	Size	Box Qty	Box Wt
57072Z	1/2"	20	4

**1 PIECE DESIGN  
TRANSITION ADAPTER (SLIP X BRASS MIP)**



Used to transition from metal MIP pipe threads to CPVC.

Part #	Size	Box Qty	Box Wt
57605Z	1/2"	25	4
57607Z	3/4"	20	5

**1 PIECE DESIGN  
TRANSITION ADAPTER (SLIP X BRASS FIP)**



Used to transition from metal FIP pipe threads to CPVC.

Part #	Size	Box Qty	Box Wt
57905Z	1/2"	25	4
57907Z	3/4"	20	5

### 1 PIECE DESIGN DROP EAR ELBOW (SLIP X STAINLESS STEEL FIP)



Used to transition from metal male pipe threads to CPVC. Provides for rigid installation by mounting elbow to wall. Usually used for shower arm or washer hose valve installation.

Part #	Size	Box Qty	Box Wt
57072S	1/2"	20	4

### 1 PIECE DESIGN TRANSITION ADAPTER (SLIP X STAINLESS STEEL MIP)



Used to transition from metal female pipe threads to CPVC.

Part #	Size	Box Qty	Box Wt
57605S	1/2"	25	4
57607S	3/4"	20	5

### 1 PIECE DESIGN TRANSITION ADAPTER (SLIP X STAINLESS STEEL FIP)



Used to transition from metal male pipe threads to CPVC.

Part #	Size	Box Qty	Box Wt
57905S	1/2"	25	4
57907S	3/4"	20	5

### CPVC to PEX Adapter (SPIGOT X STAINLESS STEEL PEX BARB)



Used to transition from copper tube-sized pipe to PEX tubing.

Part #	Size	Pkg Qty	Box Qty	Box Wt
57805S	1/2"		10	
57807S	3/4"		10	

## FLOWGUARD GOLD® PIPE



Part #	Size	Bundle Qty	Skid Qty	Ship Wt
570005S	1/2" x 10'	50	1200	37
570052S	1/2" x 20'	50	1200	74
570007S	3/4" x 10'	25	600	35
570072S	3/4" x 20'	25	600	69
570010S	1" x 10'	15	360	34
570102S	1" x 20'	15	360	68
570011S	1 1/4" x 10'	10	240	34
570112S	1 1/4" x 20'	10	240	68
570012S	1 1/2" x 10'	6	144	28
570122S	1 1/2" x 20'	6	144	57
570022S	2" x 10'	4	96	32
570222S	2" x 20'	4	96	65

## COUPLING (SLIP X SLIP)



Used to join straight lengths of CPVC.

Part #	Size	Pkg Qty	Box Qty	Box Wt
50105G	1/2"	20	1000	16
50107G	3/4"	20	500	15
50110G	1"	10	100	7
50114G	1 1/4"	10	100	10
50115G	1 1/2"	10	50	8
50120G	2"	5	25	8

## REDUCING COUPLING (SLIP X SLIP)



Used to join straight lengths of CPVC tubing. Reduces to smaller size tubing.

Part #	Size	Pkg Qty	Box Qty	Box Wt
50175G	3/4" x 1/2"	10	250	8
50117G	1" x 3/4"	10	100	5

## PVC TO CPVC ADAPTER (IPS SLIP X CTS SLIP)



Used in COLD WATER APPLICATIONS ONLY to adapt from CPVC pipe to PVC pipe.

Part #	Size	Pkg Qty	Box Qty	Box Wt
51577G	3/4"	25	250	9

## CAP (SLIP)



Used to permanently or temporarily cap CPVC tubing.

Part #	Size	Pkg Qty	Box Qty	Box Wt
50155G	1/2"	10	1000	12
50157G	3/4"	10	500	13
50158G	1"	10	100	5
50159G	1 1/4"	10	100	6
50151G	1 1/2"	10	50	6
50152G	2"	5	25	6

**REDUCING BUSHING (SPIGOT X SLIP)**

Used to reduce from fitting socket to CPVC tubing.

Part #	Size	Pkg Qty	Box Qty	Box Wt
50275G	¾" x ½"	10	250	5
50215G	1" x ½"	10	100	4
50217G	1" x ¾"	10	100	3
50245G	1¼" x ½"	10	100	6
50247G	1¼" x ¾"	10	100	6
50240G	1¼" x 1"	10	100	4
50255G	1½" x ½"	10	100	9
50257G	1½" x ¾"	10	100	9
50250G	1½" x 1"	10	100	9
50254G	1½" x 1¼"	10	100	6
50225G	2" x ½"	10	50	9
50227G	2" x ¾"	10	50	9
50220G	2" x 1"	10	100	17
50224G	2" x 1¼"	10	50	10
50221G	2" x 1½"	10	50	8

**SPECIAL FEMALE ADAPTER (SLIP X FIP)**

Used to adapt metal FIP threaded fittings to CPVC. A special elastomeric gasket ensures a leakproof seal. Hand-tighten only! This fitting seals by means of a gasket. The use of joint compound or Teflon tape is neither necessary or recommended.

Part #	Size	Pkg Qty	Box Qty	Box Wt
50305G	½"	25	500	17
50307G	¾"	25	500	20
50310G	1"	10	100	9

**MALE ADAPTER (MIP X SLIP)**

Used to adapt to metal FIP threaded fittings in COLD WATER APPLICATIONS ONLY! Where hot water or changing water temperatures are likely to be encountered, utilize the recommended TRANSITION UNIONS.

Teflon tape is the accepted method of sealing pipe threads on CPVC fittings. Do not use other materials or compounds unless specifically approved by the manufacturer.

Part #	Size	Pkg Qty	Box Qty	Box Wt
50405G	½"	20	1000	22
50407G	¾"	10	500	22
50410G	1"	10	100	7
50414G	1¼"	10	50	5
50415G	1½"	10	50	7
50420G	2"	5	25	8
50475G	½" x ¾"	10	250	8

**45° ELBOW (SLIP X SLIP)**

Used to change direction in piping.

Part #	Size	Pkg Qty	Box Qty	Box Wt
50605G	½"	20	500	11
50607G	¾"	20	500	20
50610G	1"	10	50	3
50614G	1¼"	10	50	6
50615G	1½"	10	50	10
50620G	2"	5	25	11

**90° ELBOW (SLIP X SLIP)**



Used to change direction in piping.

Part #	Size	Pkg Qty	Box Qty	Box Wt
50705G	1/2"	20	1000	24
50707G	3/4"	20	500	23
50710G	1"	10	100	9
50714G	1 1/4"	10	100	15
50715G	1 1/2"	10	50	13
50720G	2"	5	25	14

**REDUCING 90° ELBOW (SLIP X SLIP)**



Used to change direction in piping.

Part #	Size	Pkg Qty	Box Qty	Box Wt
50775G	3/4" x 1/2"	10	250	16

**45° STREET ELBOW (SLIP X SPIGOT)**



Used on close offsets where very short pieces of CPVC pipe would otherwise have to be used with conventional 45° elbows. A principal use is to offset piping over and around existing piping mounted on flat surfaces such as wall or ceiling.

Part #	Size	Pkg Qty	Box Qty	Box Wt
52705G	1/2"	25	500	14
52707G	3/4"	25	500	23

**90° STREET ELBOW (SLIP X SPIGOT)**



Used to change direction in piping 90° from a fitting socket. The 3/4" elbow (Part #52907G) can also be used as a 3/4" x 1/2" reducing elbow.

Part #	Size	Pkg Qty	Box Qty	Box Wt
52905G	1/2"	10	500	16
52907G	3/4"	10	250	16

**TEE (SLIP X SLIP X SLIP)**



Used to provide a branch supply line from a main line.

Part #	Size	Pkg Qty	Box Qty.	Box Wt
51405G	1/2"	20	1000	33
51407G	3/4"	20	500	35
51410G	1"	10	100	12
51414G	1 1/4"	10	50	10
51415G	1 1/2"	5	25	8
51420G	2"	5	25	17

**REDUCING TEE (SLIP X SLIP X SLIP)**

Part #	Size	Pkg Qty	Box Qty	Box Wt
51471G	¾" x ¾" x ½"	25	250	16
51473G	¾" x ½" x ½"	25	250	14
51476G	¾" x ½" x ¾"	25	250	16
51475G	1" x 1" x ½"	5	25	3
51477G	1" x 1" x ¾"	5	25	3
51490G	1¼" x 1¼" x ½"	5	25	4
51491G	1¼" x 1¼" x ¾"	5	25	4
51474G	1¼" x 1¼" x 1"	5	25	5
51493G	1½" x 1½" x ½"	5	25	7
51494G	1½" x 1½" x ¾"	5	25	7
51495G	1½" x 1½" x 1"	5	25	7
51419G	1½" x 1½" x 1¼"	5	25	8
51435G	2" x 2" x 1"	5	25	14
51436G	2" x 2" x 1¼"	5	25	15
51472G	2" x 2" x 1½"	5	25	16

**SPECIAL FEMALE WING ELBOW (SLIP X FIP)**

This elbow adapts from ½" CPVC to ½" male metal pipe threads and features lugs for fastening. A special elastomeric gasket ensures a leakproof seal. Used on tub and shower faucets to adapt from the ½" CPVC riser to the chrome shower arm. Sometimes called a "Drop Ear" elbow.

Hand tighten only! This fitting seals by means of a gasket and the use of joint compound or Teflon tape is neither necessary or recommended.

Part #	Size	Pkg Qty	Box Qty	Box Wt
53055G	½"		100	8

**WING ELBOW (SLIP X SLIP)**

This elbow is used to change direction in piping and features lugs for fastening. Often used in conjunction with Washer Hose Valve for hooking up to automatic clothes washers as well as fabricating water supply piping stub outs for toilet installation. Sometimes called a "Drop Ear" elbow.

Part #	Size	Pkg Qty	Box Qty	Box Wt
53056G	½"		90	4

**UNION (SLIP X SLIP)**

This union solvent welds directly to CPVC tubing and provides a method for future disassembly of piping without cutting.

Part #	Size	Pkg Qty	Box Qty	Box Wt
53021G	½"		100	12
53026G	¾"		110	19

**90° SWIVEL ELBOW (SLIP X FEMALE NPSM)**

Allows a direct 90° connection between CPVC tubing and male running threads on faucet. Has a cone washer inside female end to achieve seal.

Part #	Size	Pkg Qty	Box Qty	Box Wt
54935G	½"	25	50	3

**SWIVEL ADAPTER COUPLING****(SLIP X FEMALE NPSM)**

Allows a direct connection between supply tube and male running threads on faucet. Has a cone washer inside female end to achieve seal.

Part #	Size	Pkg Qty	Box Qty	Box Wt
54950G	½"	25	250	12

**BALL VALVES (SLIP X SLIP)**

These ball valves are full flow valves with Teflon® seal and quarter turn operation.

Part #	Size	Pkg Qty	Box Qty	Box Wt
57305	½"		10	2
57307	¾"		5	3
57310	1"	12	72	34
57314	1¼"	12	72	42
57315	1½"	10	60	55
57320	2"	8	48	83

\*Hi Impact CPVC



# UNIVERSAL FITTINGS

Universal Fittings are copper tube size products (CTS) used in hot and cold potable water distribution systems in residential, marine, and RV applications. All sizes listed are nominal, which are approximately the same as the inside diameter (I.D.). The outside diameter (O.D.) of CTS tubing is the nominal size plus 1/8".

Nominal Size	1/4"	3/8"	1/2"	3/4"
Outside Diameter	3/8"	1/2"	5/8"	7/8"



## Universal Fittings

- Meets ASSE 1061
- 200 PSI @ 73°F & 100 PSI @ 180°F

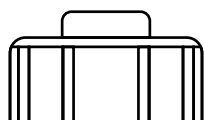

Plastic Nut



Gripper Ring

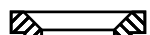

Body Spacer

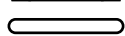

O-Ring

- Avoid installation where product will be exposed to excessive sunlight.
- Universal Fittings
  - Leak-proof mechanical joints
  - Hand-tighten only!
  - Connects to copper, CPVC, and other copper tube size products
  - Note the order in which each of the component parts are installed. Be sure all parts are present and in this order before installing.

**COUPLING**

Designed to join PEX, copper, or CPVC tubing.

Part #	Size	Pkg Qty	Box Qty	Box Wt
541031	¼" (C)		5	1
541051	½" (C)		5	1
54105	½"	10	20	2
541071	¾" (C)		5	1
54107	¾"	10	20	3

**REDUCING COUPLING**

Designed to join PEX, copper, or CPVC tubing.

Part #	Size	Pkg Qty	Box Qty	Box Wt
541531	½" x ¼" (C)		5	1
54153	½" x ¼"	10	20	2

**SPECIAL FEMALE ADAPTER (FIP)**

Designed to adapt from metal male pipe thread to PEX, copper, or CPVC tubing.

Hand tighten only! This fitting seals by means of a gasket and the use of joint compound or PTFE thread tape is neither necessary nor recommended.

Part #	Size	Pkg Qty	Box Qty	Box Wt
543051	½" (C)		5	1
54305	½"	10	20	2
543071	¾" (C)		5	1
54307	¾"	10	20	2

**REDUCING FEMALE ADAPTER**

Designed to adapt from metal male pipe thread to PEX, copper, or CPVC tubing. Connects Water Softeners to in home plumbing supply.

Hand tighten only! This fitting seals by means of a gasket and the use of joint compound or PTFE thread tape is neither necessary nor recommended.

Part #	Size	Pkg Qty	Box Qty	Box Wt
54310	1" x ¾"	10	20	3
543101	1" x ¾"	5	20	3

**MALE ADAPTER (MIP)**

Designed to adapt from metal female pipe thread to PEX, copper, or CPVC tubing on the COLD WATER SIDE ONLY of a hot and cold water supply system.

Where hot or changing temperatures are likely to be encountered, utilize a short metal nipple in conjunction with a Genova Universal Fitting Special Female Adapter. PTFE tape is the accepted method of sealing pipe threads or CPVC fittings. Do not use other materials or compounds unless specifically approved by the manufacturer.

Part #	Size	Pkg Qty	Box Qty	Box Wt
544051	½" (C)		5	1
54405	½"	10	20	2
544071	¾" (C)		5	1
54407	¾"	10	20	2

**90° ELBOW**

Used to change direction in piping and is designed to join PEX, copper, or CPVC tubing.

Part #	Size	Pkg Qty	Box Qty	Box Wt
547051	½" (C)		5	1
54705	½"	10	20	3
547071	¾" (C)		5	1
54707	¾"	10	20	2

**90° SWIVEL ELBOW**



Allows a direct 90° connection between 5/8" O.D. PEX, copper, or CPVC tubing and male running threads on faucet. Has a cone washer inside female end to achieve seal.

Hand tighten only! This fitting seals by means of a gasket and the use of joint compound or PTFE thread tape is neither necessary nor recommended.

Part #	Size	Pkg Qty	Box Qty	Box Wt
54905	1/2"	10	20	3

**TEE**



This fitting is used to provide a branch from a main line and is designed to join to PEX, copper, or CPVC tubing.

Part #	Size	Box Qty	Box Wt
545051	1/2" (C)	5	1
54505	1/2"	10	2
545071	3/4" (C)	5	2
54507	3/4"	10	3

**REDUCING TEE**



Used to provide a branch from a main line and is designed to join PEX, copper, or CPVC tubing.

Part #	Size	Box Qty	Box Wt
54575	3/4" x 3/4" x 1/2"	10	3

**LINE VALVE**



The unique valve mechanically joins water supply tubing utilizing a special locking ring and elastomeric seal. It can be used to join PEX, copper or CPVC tubing.

Part #	Size	Box Qty	Box Wt
540051	1/2" (C)	5	2
54005	1/2"	10	3
540071	3/4" (C)	5	2
54007	3/4"	10	4

**STRAIGHT SUPPLY VALVE**



Adapts mechanically and is used where toilet, vanity or sink water supply piping comes through the floor. Designed to join PEX, copper, or CPVC tubing.

Part #	Size	Box Qty	Box Wt
530301	1/2" x 1/4" (C)	10	3
53030	1/2" x 1/4"	10	2

**ANGLE SUPPLY VALVE**



Adapts mechanically and is used where toilet, vanity or sink water supply piping comes through the wall. Designed to join PEX, copper, or CPVC tubing.

Part #	Size	Box Qty	Box Wt
530651	1/2" x 1/4" (C)	10	3
53065	1/2" x 1/4"	10	2

**SPECIAL FEMALE WING ELBOW**

Mechanically joins ½" water supply piping to male pipe threads. A special elastomeric gasket ensures a leakproof seal. Usually used for a shower arm connection.

Hand tighten only! This fitting seals by means of a gasket and the use of joint compound or PTFE thread tape is not necessary or recommended.

Part #	Size	Pkg Qty	Box Qty	Box Wt
540551	½" (C)		5	1
54055	½"	10	20	3

**REDUCING GENOGRIP™ ADAPTER**

(SLIP X TUBING)



Solvent welds directly onto ½" CPVC tubing and adapts mechanically to ¾" O.D. Pex tubing or copper tubing. Most often used to adapt from ½" CPVC tubing risers through floor ¾" O.D. closet and/or lavatory riser tubes. Can also be used with metal risers.

Part #	Size	Pkg Qty	Box Qty	Box Wt
530101	½" x ¼" (C)		10	1
53010	½" x ¼"	25	50	3

**GENOGRIP™ ANGLE ADAPTER (SLIP X TUBING)**

Solvent welds directly onto ½" CPVC tubing and adapts mechanically to ¾" O.D. Pex tubing or copper tubing. Most often used to adapt from ½" CPVC tubing risers through floor ¾" O.D. closet and/or lavatory riser tubes. Can also be used with metal risers.

Part #	Size	Pkg Qty	Box Qty	Box Wt
53060	½" x ¼"	10	50	3

**GENOGRIP™ STREET ADAPTER**

(SPIGOT X TUBING)



These patented adapters solvent weld directly into standard fittings and adapt mechanically to both PEX tubing and copper tubing by utilizing a special metal gripper ring supplied with the fitting. These fittings can be used in conjunction with CPVC fittings to create an unlimited range of fittings to connect to any type of water supply tubing.

Part #	Size	Pkg Qty	Box Qty	Box Wt
530751	½" (C)		10	2
53075	½"		25	2
530851	¾" (C)		10	2
53085	¾"	10	20	2

**REDUCING GENOGRIP™ STREET ADAPTER**

(SPIGOT X TUBING)



Allows any fitting hub to be reduced to accept PEX, copper or CPVC tubing.

Part #	Size	Pkg Qty	Box Qty	Box Wt
540031	½" x ¼" (C)		10	1
53070	½" x ¼"	25	50	2
540021	½" x ¾"		10	2
540011	¾" x ½"		10	2

**HOSE COUPLER**

Adapts male hose threads to CPVC, Pex or copper tubing.

Part #	Size	Pkg Qty	Box Qty	Box Wt
54124	¾"	10	20	2

## METAL GRIPPER RINGS



Available for replacement purposes in Genova's Universal fittings. 2 gripper rings of each size are included in each bags.

( $\frac{1}{4}$ ",  $\frac{1}{2}$ ",  $\frac{3}{4}$ " I.D.)

Part #	Pkg Qty	Box Qty	Box Wt
540001	10	20	1

## TUBING HANGERS



**(Note: ORDER BY THE BAG)**

Incorporates a special design which allows for pipe expansion. Can be used on copper as well as CPVC. Genova recommends using #8 x 1" screws which do not require pre-drilling.

Part #	Size	Pkg Qty	Box Qty (legths)	Box Wt
521051	$\frac{1}{2}$ " 10/bag (C)		10	1
52105	$\frac{1}{2}$ " 25/bag	1	25	5
521071	$\frac{3}{4}$ " 10/bag (C)		10	2
52107	$\frac{3}{4}$ " 25/bag	1	25	10

## TUBING STRAPS



**(Note: ORDER BY THE BAG)**

Incorporates a special design which allows for pipe expansion. Can be used on copper, CPVC, and PEX tubing. Genova recommends using #6 x 1" screws which do not require pre-drilling.

Part #	Size	Pkg Qty	Box Qty (legths)	Box Wt
52115	$\frac{1}{2}$ " 25/bag	1	25	4
52117	$\frac{3}{4}$ " 25/bag	1	25	5

**WATER HAMMER MUFFLER**

A permanent replacement for conventional air chambers that waterlog in a short period of time. Eliminates potential damage to water supply pipes caused by water hammer. Adapts to all water supply piping systems, plastic or metal.

Part #	Size	Box Qty	Box Wt
53090	1/2"	10	8

**PLASTIC TUBING CUTTERS**

Easy-to-use cutter for plastic pipe with a heat treated blade. Ideal for CPVC or PEX tubing.

Part #	Size	Box Qty	Box Wt
534991	(C)	5	4
53499		5	4

**TUBING CUTTER REPLACEMENT BLADES**

For use with Part #534991 or 53499 Genova Plastic Tubing Cutter.

Part #	Size	Box Qty	Box Wt
534961	(C)	10	2

**ID/OD Chart**

Nominal Size	1/4"	3/8"	1/2"	3/4"
Outside Diameter	3/8"	1/2"	5/8"	7/8"

# SCH. 30 PVC-DWV PIPE & FITTINGS

Sch. 30 (3.25" O.D.) DWV pipe and fittings are used in drain, waste, and vent applications and are designed to fit inside a 2" x 4" wall.



## Sch. 30 DWV Pipe

- Solid Wall meets ASTM D2949
- Cellular Core meets ASTM F1488
- NSF Listed

## Sch. 30 DWV Fittings

- NSF Listed

- Permitted under the International Plumbing Code (IPC) and International Residential Code (IRC).
- Solvent weld joints.

Phone: 1-800-521-7488 or (810) 744-4500  
 Fax: (810) 744-3130  
 Email: [inquiry@genovaproducts.com](mailto:inquiry@genovaproducts.com)  
 Hours: 8 AM to 5 PM EST Monday - Friday

**SCH. 30 PVC-DWV PIPE**

Part #	Size	Bdl Qty (Lgths)	Skid Qty (Lgths)	Bdl Wt (Lbs)
60031	3" x 10'	5	75	42
60032	3" x 20'	5	75	83

**SCH. 30 PVC-DWV CELLULAR CORE PIPE**

Note: Be sure to order by the length.

Part #	Size	Bdl Qty (Lgths)	Skid Qty (Lgths)	Bdl Wt (Lbs)
60031F	3" x 10'	5	75	32
60032F	3" x 20'	5	75	64

**COUPLING (HUB X HUB)**

Used to join straight lengths of pipe.

Part #	Size	Box Qty	Box Wt
60130	3"	20	6

**REDUCING COUPLING (HUB X HUB)**

Used to increase or reduce pipe sizes.

Part #	Size	Box Qty	Box Wt
60131	3" x 1½"	20	7
60132	3" x 2"	20	6
60143	4" x 3"	20	16

**REPAIR COUPLING (NO STOP) (HUB X HUB)**

Furnished without center stop so that stationary lengths of pipe can be spliced together.

Part #	Size	Box Qty	Box Wt
60133	3"	20	8

**CAP (HUB)**

Used for permanently or temporarily capping pipe.

Part #	Size	Box Qty	Box Wt
60153	3"	20	6

**REDUCING BUSHING (SPIGOT X HUB)**



Inserts into fitting hub to reduce to smaller pipe size.

**SCH. 30 X DWV**

Part #	Size	Box Qty	Box Wt
60231	3" x 1½"	20	7
60232	3" x 2"	20	8

**DWV X SCH. 30**

Part #	Size	Box Qty	Box Wt
60243	4" x 3"	10	6

**SCH. 40 TO SCH. 30 BUSHING (HUB X SPIGOT)**



This flush sleeve adapts a Sch. 40 I.P.S. (700 Series) fitting hub to Sch. 30 (600 Series) pipe size.

Part #	Size	Box Qty	Box Wt
65330	3"	20	3

**FEMALE ADAPTER (HUB X FIP)**



Adapts to standard male pipe threads. PTFE thread tape is recommended for threaded joints.

Part #	Size	Box Qty	Box Wt
60330	3"	20	10

**MALE ADAPTER (HUB X MIP)**



Adapts to standard female pipe threads. PTFE thread tape is recommended for threaded joints.

Part #	Size	Box Qty	Box Wt
60430	3"	20	7

**SEWER PIPE ADAPTER (SEWER HUB X SCH. 30 HUB)**



Adapts 3" Sch. 30 pipe to 4" sewer pipe (400 Series).

Part #	Size	Box Qty	Box Wt
61543	4" x 3"	20	9

**CAST IRON PIPE SPIGOT ADAPTER (HUB X HUB)**



This fitting adapts 3" Sch. 30 pipe to 3" cast iron spigot. Can be joined to cast iron with oakum and poured lead or lead substitute.

Part #	Size	Box Qty	Box Wt
61730	3" x 3" C.I.	10	5

**22½° ELBOW (HUB X HUB)**

Used to change direction in piping. Sometimes called a "Sixteenth Bend".

Part #	Size	Box Qty	Box Wt
60830	3"	20	10

**45° ELBOW (HUB X HUB)**

Used to change direction in piping. Sometimes called an "Eighth Bend".

Part #	Size	Box Qty	Box Wt
60630	3"	20	10

**45° STREET ELBOW (HUB X SPIGOT)**

Used to change direction in piping. Sometimes called a "Street Eighth Bend".

Part #	Size	Box Qty	Box Wt
62730	3"	20	9

**60° ELBOW (HUB X HUB)**

Used to change direction in piping. Sometimes called a "Sixth Bend".

Part #	Size	Box Qty	Box Wt
60930	3"	20	12

**90° SANITARY ELBOW (HUB X HUB)**

Used to change direction in piping. Sometimes called a "Quarter Bend".

Part #	Size	Box Qty	Box Wt
62830	3"	20	14

**90° SANITARY STREET ELBOW (HUB X SPIGOT)**

Used to change direction in piping. Sometimes called a "Street Quarter Bend".

Part #	Size	Box Qty	Box Wt
62936	3"	20	14

**WYE (HUB X HUB X HUB)**



Used when connecting a branch line into a horizontal drain pipe. Also, used in conjunction with a "Twist-Lok"™ plug to provide a cleanout in a drain pipe.

Part #	Size	Box Qty	Box Wt
61030	3"	20	19

**REDUCING WYE (HUB X HUB X HUB)**



Used when connecting a branch line into a horizontal drain pipe. Also, used in conjunction with a "Twist-Lok"™ plug to provide a cleanout in a drain pipe.

Part #	Size	Box Qty	Box Wt
61031	3" x 3" x 1½"	20	15
61032	3" x 3" x 2"	20	16

**STANDARD DOUBLE WYE (ALL HUB)**



Used to bring two branch lines into a horizontal drain pipe.

Part #	Size	Box Qty	Box Wt
63430	3"	10	16

**SANITARY TEE (HUB X HUB X HUB)**



Used to connect a branch line into a vertical drain pipe.

Part #	Size	Box Qty	Box Wt
61130	3"	20	22

**TEST TEE W/PLUG (HUB X HUB X FIP)**



Installs in vertical drain pipes to provide a cleanout opening close to the floor and flush with the finished wall.

Part #	Size	Pkg Qty	Box Qty	Box Wt
61330	3"	1	10	10

**REDUCING SANITARY TEE (HUB X HUB X HUB)**



Used to connect a reducing branch line into a vertical pipe drain.

Part #	Size	Box Qty	Box Wt
61131	3" x 3" x 1½"	20	12
61132	3" x 3" x 2"	20	17

**DOUBLE SANITARY TEE (ALL HUB)**

Used to bring two branch lines into a vertical drain pipe.

Part #	Size	Box Qty	Box Wt
63530	3"	10	16

**REDUCING DOUBLE SANITARY TEE (ALL HUB)**

Used to bring two branch lines into a vertical drain pipe.

Part #	Size	Box Qty	Box Wt
63531	3" x 3" x 1½" x 1½"	10	10
63532	3" x 3" x 2" x 2"	10	10

**FITTING CLEANOUT BODY (SPIGOT X FIP)**

Solvent welds into fitting hub and adapts to male threaded plug. PTFE thread tape is recommended for threaded joints.

Part #	Size	Box Qty	Box Wt
61629	3"	20	7

**FITTING CLEANOUT W/THREADED PLUG**

Solvent welds into fitting hub to provide access to piping. PTFE thread tape is recommended for threaded joints.

Part #	Size	Box Qty	Box Wt
61630	3"	20	10

**"POP-TOP" CLOSET FLANGE**

Solvent welds over 3" Sch. 30 pipe. Unique "Pop-Top" feature prevents debris from entering plumbing system prior to setting the toilet. Used for mounting toilet base to drain.

Part #	Size	Pkg. Qty.	Box Qty	Box Wt
65134	4" x 3"	HUB	20	14

**CLOSET FLANGE W/METAL RING**

Solvent welds directly into 3" Sch. 30 fitting hub. This flange has an adjustable metal ring which allows for easier toilet alignment.

Part #	Size	Pkg. Qty.	Box Qty	Box Wt
65139	4" x 3"	SPIGOT	20	14

**CLOSET FLANGE W/METAL RING**

Solvent welds over 3" Sch. 30 pipe. This flange has an adjustable metal ring which allows for easier toilet alignment and is used for mounting toilet base to drain.

Part #	Size	Pkg. Qty.	Box Qty	Box Wt
65150	4" x 3"	HUB	10	8

**SADDLE (STREET/SOCKET DESIGN)**



Solvent welds directly onto the side of a 3" pipe to provide a simple way of connecting a branch into a drain pipe. The inlet is constructed to accept a 2" fitting over its outside diameter or a 1½" pipe into its inside diameter.

Part #	Size	Box Qty	Box Wt
61231	3" x 1½"/2"	20	6

**TWIST-LOK™ PLUG (PATENT NO. 3,677,301)**



This unique Genova way of providing an easily removable closure at any fitting hub. A patented Genova system feature.

Part #	Size	Box Qty	Box Wt
61873	3"	20	5

**VINYL "HUB-FIT" FLOOR STRAINER**



Prevents debris from entering a drain opening on the floor. Fits flush into any fitting hub.

Part #	Size	Box Qty	Box Wt
69230	3"	20	5

**SPECIAL WASTE & VENT FITTING**

(SINGLE CONFIGURATION)



This special stack fitting provides for the hookup and venting of a complete bathroom. Each unit includes a flush branch plug to enable utilizing the fitting in a right or left hand drain situation. Branch inlets are 2" socket configurations to accept 2" pipe. Bushings (Part #70221) are provided to accommodate 1½" pipe.

Part #	Size	Pkg Qty	Box Qty	Box Wt
67530	3" x 1½"/2" w/3" CAP	1	5	13

**SPECIAL WASTE & VENT FITTING**

(DOUBLE CONFIGURATION)



This special stack fitting provides for the hookup and venting of all drains from two complete bathrooms located back to back. Each unit includes two flush branch plugs to enable utilizing the fitting in a right or left hand drain situation. Branch inlets are 2" socket configurations to accept 2" pipe. Bushings (Part #70221) are provided to accommodate 1½" pipe.

Part #	Size	Pkg Qty	Box Qty	Box Wt
67930	3" x 1½"/2" w/3" CAP	1	5	15



# PVC-DWV PIPE & FITTINGS

Poly Vinyl Chloride (PVC) DWV pipe and fittings are used for drain, waste, and vent applications.



## Sch. 40 PVC DWV Pipe

- Dual rated for pressure (ASTM D1785) and drainage (ASTM D2665) applications
- NSF Listed

## Sch. 40 Cellular Core PVC DWV Pipe

- Meets ASTM F891
- NSF Listed

## DR-24 DWV Pipe

- Meets ASTM F1488
- Use with Sch. 40 DWV Fittings
- NSF Listed

## Sch. 40 DWV Fittings

- Meets ASTM D2665
- NSF Listed

- Pipe diameters are the same as iron pipe. (IPS = Iron Pipe Size)
- Solvent weld joints
- Sch. 40 PVC, meeting ASTM D 2665 or F 891, is permitted by all major model plumbing codes. DR-24 pipe, meeting ASTM F1488, is permitted by the International Plumbing Code (IPC) and International Residential Code (IRC).
- Solvent welding vinyl pipe and fittings is a permanent process. To eliminate costly errors, Genova pipe features a plumb line as a reference mark relative to the degree marks on Genova fittings.

Phone: 1-800-521-7488 or (810) 744-4500  
 Fax: (810) 744-3130  
 Email: [inquiry@genovaproducts.com](mailto:inquiry@genovaproducts.com)  
 Hours: 8 AM to 5 PM EST Monday - Friday

**SCH. 40 PVC-DWV PIPE**

Note: Be sure to order by the length not by the foot.

Part #	Size	PSI	Bdl Qty (lgths)	Skid Qty (lgths)	Bdl Wt (lbs)
70011	1½" x 10'	330	5	180	27
70012	1½" x 20'	330	5	90	53
70021	2" x 10'	280	5	140	35
70022	2" x 20'	280	5	70	70
70031	3" x 10'	260	5	75	72
70031B	3" x 10' Belled	260	5	75	72
70032	3" x 20'	260	5	50	144
70032B	3" x 20' Belled	260	3	48	86
70041	4" x 10'	220	3	54	61
70041B	4" x 10' Belled	220	3	54	61
70042	4" x 20'	220	3	36	122
70042B	4" x 20' Belled	220	3	36	124
70061	6" x 10'	180	1	24	37
70061B	6" x 10' Belled	180	1	24	37
70062	6" x 20'	180	1	24	73
70062B	6" x 20' Belled	180	1	24	73

**SCH. 40 PVC-DWV CELLULAR CORE PIPE**

Note: Be sure to order by the length not by the foot.

Part #	Size	Bdl Qty (lgths)	Skid Qty (lgths)	Bdl Wt (lbs)
70011F	1½" x 10'	5	180	18
70012F	1½" x 20'	5	90	36
70021F	2" x 10'	5	140	22
70022F	2" x 20'	5	70	44
70031F	3" x 10'	5	75	53
70031FB	3" x 10' Belled	5	75	53
70032F	3" x 20'	5	50	105
70032FB	3" x 20' Belled	5	50	105
70041F	4" x 10'	3	54	44
70041FB	4" x 10' Belled	3	54	44
70042F	4" x 20'	3	36	88
70042FB	4" x 20' Belled	3	36	88

Part #	Size	Bdl Qty (lgths)	Skid Qty (lgths)	Bdl Wt (lbs)
70061F	6" x 10'	1	24	50
70061FB	6" x 10' Belled	1	24	50
70062F	6" x 20'	1	24	50
70062FB	6" x 20' Belled	1	24	50

**SCH. 40 PVC-DWV CELLULAR CORE PERFORATED PIPE**

Note: Be sure to order by the length not by the foot.

Part #	Size	Bdl Qty (lgths)	Skid Qty (lgths)	Bdl Wt (lbs)
70048FB	4" x 10' Belled	3	54	44

**DR-24 PVC-DWV PIPE**

Note: Be sure to order by the length not by the foot.  
N= non-bundled

Part #	Size	Bdl Qty (lgths)	Skid Qty (lgths)	Bdl Wt (lbs)
79011	1½" x 10'	3	180	15
79012N	1½" x 20'		90	
79021	2" x 10'	5	140	24
79022N	2" x 20'		70	
79031	3" x 10'	5	75	44
79032N	3" x 20'		50	
79041	4" x 10'	3	54	41

**COUPLING (HUB X HUB)**

Used to join straight lengths of pipe.

Part #	Size	Pkg Qty	Box Qty	Box Wt
70114	1¼"		50	5
70115	1½"	20	100	11
70120	2"	20	100	15
70130	3"		20	11
70140	4"		10	9
70160	6"		1	2

**REPAIR COUPLING (NO STOP) (HUB X HUB)**

Furnished without center stop so that stationary lengths of pipe can be spliced together.

Part #	Size	Pkg Qty	Box Qty	Box Wt
70116	1½"	20	100	10
70122	2"	20	100	16
70133	3"		20	10
70144	4"		10	9

**REDUCING COUPLING (HUB X HUB)**

Used to reduce or increase pipe sizes.

Part #	Size	Pkg Qty	Box Qty	Box Wt
70121	2" x 1½"	20	100	16
70131	3" x 1½"		20	9
70132	3" x 2"		20	9
70142	4" x 2"		20	16
70143	4" x 3"		20	18
70164	6" x 4"		4	9

**CAP (HUB)**

Used for permanently or temporarily capping pipe.

Part #	Size	Pkg Qty	Box Qty	Box Wt
70151	1½"	20	100	9
70152	2"	20	100	12
70153	3"		20	9
70154	4"		10	8
70156	6"	1	10	20

**REDUCING BUSHING (SPIGOT X HUB)**

Inserts into fitting hub to reduce to smaller pipe size.

Part #	Size	Pkg Qty	Box Qty	Box Wt
70211	1½" x 1¼"		50	3
70224	2" x 1¼"	10	70	8
70221	2" x 1½"	20	100	8
70231	3" x 1½"		20	8
70232	3" x 2"		20	9
70242	4" x 2"		10	7
70243	4" x 3"		10	6
70264	6" x 4"	1	10	19

**FLUSH REDUCING BUSHING (SPIGOT X HUB)**

Adapts 4" fitting hub to 3" pipe.

Part #	Size	Box Qty	Box Wt
76243	4" x 3"	10	6

**ADAPTER BUSHING**

(DWV SPIGOT X S & D HUB)



Adapts Sch. 40 fitting hub to sewer pipe.

Part #	Size	Box Qty	Box Wt
75340	4"	25	6

**ADAPTER BUSHING**

(S &amp; D SPIGOT X DWV HUB)



Adapts Sch. 40 pipe to sewer fitting hub.

Part #	Size	Box Qty	Box Wt
74243	4" x 3"	20	9

**SEWER PIPE ADAPTER COUPLING**

(SEWER HUB X SCH. 40 HUB)



Adapts Sch. 40 pipe to 4" sewer pipe.

Part #	Size	Box Qty	Box Wt
71543	4" x 3"	20	12
71544	4" x 4"	10	7

**FEMALE ADAPTER (HUB X FIP)**

Adapts to standard male pipe threads. PTFE thread tape is recommended for threaded joints.

Part #	Size	Pkg. Qty.	Box Qty	Box Wt
70311	1½" x 1¼"	20	100	11
70314	1¼"		50	6
70315	1½"	20	100	12
70320	2"	20	100	17
70330	3"		20	12
70340	4"		10	9
70360	6"	1	10	20

**MALE ADAPTER (HUB X MIP)**

Adapts to standard female pipe threads. PTFE thread tape is recommended for threaded joints.

Part #	Size	Pkg. Qty.	Box Qty	Box Wt
70414	1¼"		50	5
70411	1½" x 1¼"	20	100	10
70415	1½"	20	100	9
70420	2"	20	100	14
70430	3"		20	9
70440	4"		10	8

**HUB ADAPTER (SPIGOT X HUB)**Adapts cast iron  
HUB to sch. 40  
DWV pipe

Can be joined to cast iron with oakum and poured lead or lead substitute. Bushing (Part # 70232) provided to reduce to 2".

Part #	Size	Box Qty	Box Wt
70521	2" x 1½"	20	7
70520	2" x 2"	25	9
70530	3" x 3"	20	16
70543	4" x 3"	20	19
70540	4" x 4"	10	13

**NO-HUB\* ADAPTER (HUB X SPIGOT)**

Provides a proper method of adapting from no-hub cast iron pipe utilizing the standard no-hub clamp ring.

\*No-Hub is a registered trademark of the Cast Iron Soil Pipe Institute.

Part #	Size	Pkg. Qty.	Box Qty	Box Wt
72120	2"	20	100	17
72130	3"		20	8
72140	4"		10	7

**CAST IRON PIPE SPIGOT ADAPTER**

(HUB X HUB)



This fitting adapts Genova Sch. 40 pipe to 4" cast iron spigot and can be joined to cast iron with oakum and poured lead or poured lead substitute.

Part #	Size	Box Qty	Box Wt
71730	3"	10	9
71740	4"	10	13

**TRAP ADAPTER (HUB X SLIP JAMNUT)**

Utilized to adapt PVC pipe to tubular traps at wall or floor. Utilizes special washer which seals to either 1½" or 1¼" tubular products, reducing the number of SKU's needed in inventory. This fitting solvent welds over a 1½" DWV pipe. Sometimes called a Marvel.

\* Dynamic Duo feature.

Part #	Size	Pkg Qty	Box Qty	Box Wt
72211*	1½" x 1¼"/1½"	20	100	13
72215	1½" x 1½"	20	100	12

**FITTING TRAP ADAPTER**

(SPIGOT X SLIP JAMNUT)



Adapts PVC fitting hub to tubular traps at wall or floor. Utilizes special washer which seals to either 1½" or 1¼" tubular products, reducing the number of SKU's needed in inventory. This fitting solvent welds into a 1½" DWV fitting hub. Sometimes called a Marvel.

\* Dynamic Duo feature.

Part #	Size	Pkg Qty	Box Qty	Box Wt
72311*	1½" x 1¼"/1½"	20	100	14
72315	1½" x 1½"	20	100	13

**FITTING ADAPTER (SPIGOT X MIP)**

Adapts fitting hub to standard female pipe threads. PTFE thread tape is recommended for threaded joints.

Part #	Size	Pkg Qty	Box Qty	Box Wt
72411	1½" x 1¼"	20	100	9
72415	1½"	20	100	10
72420	2"	20	100	14

**22½° ELBOW (HUB X HUB)**

Used to change direction in piping. Sometimes called a "Sixteenth Bend".

Part #	Size	Pkg Qty	Box Qty	Box Wt
70815	1½"	20	100	16
70820	2"	20	5	5
70830	3"	20	16	16
70840	4"	10	13	13
70860	6"	5	12	12

**22½° STREET ELBOW (HUB X SPIGOT)**

Used to change direction in piping. Sometimes called a "Street Sixteenth Bend".

Part #	Size	Pkg Qty	Box Qty	Box Wt
75815	1½"	20	100	14
75820	2"	20	4	4
75830	3"	20	14	14
75840	4"	10	12	12

**45° SANITARY ELBOW (HUB X HUB)**

Used to change direction in piping. Sometimes called an "Eighth Bend".

Part #	Size	Pkg Qty	Box Qty	Box Wt
70614	1¼"		50	9
73615	1½"	20	100	22
73620	2"	20	100	32
70630	3"		20	20
70640	4"		10	18
70660	6"		1	4

**45° ELBOW (HUB X HUB)**

Used to change direction in piping. Sometimes called an "Eighth Bend".

Part #	Size	Pkg Qty	Box Qty	Box Wt
70615	1½"	20	100	16
70620	2"	20	100	23

**45° SANITARY STREET ELBOW (HUB X SPIGOT)**

Used to change direction from a fitting hub to a pipe. Sometimes called a "Street Eighth Bend".

Part #	Size	Pkg Qty	Box Qty	Box Wt
72714	1¼"		50	7
72716	1½"	20	100	20
72720	2"	20	100	31
72730	3"		20	18
72740	4"		10	17
72760	6"		1	3

**45° STREET ELBOW (HUB X SPIGOT)**

Used to change direction from a fitting hub to a pipe. Sometimes called a "Street Eighth Bend".

Part #	Size	Pkg Qty	Box Qty	Box Wt
72715	1½"	20	100	15

**60° ELBOW (HUB X HUB)**

Used to change direction in piping. Sometimes called a "Sixth Bend".

Part #	Size	Pkg Qty	Box Qty	Box Wt
70915	1½"	20	100	20
70920	2"		20	6
70930	3"		20	19
70940	4"		10	16

**90° LONG SWEEP ELBOW (HUB X HUB)**

Used to change direction in piping. Sometimes called a "Long Turn Quarter Bend".

Part #	Size	Pkg Qty	Box Qty	Box Wt
73815	1½"	20	100	33
73820	2"	20	80	37
73830	3"		20	28
73840	4"		10	24

**90° SANITARY ELBOW (HUB X HUB)**

Used to change direction in piping. Sometimes called a "Quarter Bend".

Part #	Size	Pkg Qty	Box Qty	Box Wt
72814	1¼"		50	10
72815	1½"	20	100	23
72820	2"	20	100	37
72821	2" x 1½"	20	100	30
72830	3"		20	24
72840	4"		10	21
72860	6"		1	4

**90° SANITARY STREET ELBOW**

(HUB X SPIGOT)



Used to change direction in piping. Sometimes called a "Street Quarter Bend".

Part #	Size	Pkg Qty	Box Qty	Box Wt
72906	1¼"		50	9
72916	1½"	20	100	22
72926	2"		20	8
72936	3"		20	22
72946	4"		10	20
72966	6"		5	23

**90° VENT STREET ELBOW (HUB X SPIGOT)**

Used to change direction in "dry" portion of vent piping where water flow is not a consideration. Sometimes called a "Short Turn Street Quarter Bend".

Part #	Size	Pkg Qty	Box Qty	Box Wt
72915	1½"	20	100	19
72920	2"		20	6

**90° VENT ELBOW (HUB X HUB)**

Used to change direction in the "dry" portion of vent piping where water flow is not a consideration. Sometimes called a "Short Turn Quarter Bend".

Part #	Size	Pkg Qty	Box Qty	Box Wt
70715	1½"	20	100	21
70720	2"		20	6
70730	3"		20	18

**REDUCING CLOSET BEND (HUB X HUB)**

Used to change direction in piping as well as size. Usually utilized to convert from 3" horizontal pipe to 4" vertical pipe directly under the toilet.

Part #	Size	Box Qty	Box Wt
72834	4" x 3"	20	32

**REDUCING CLOSET BEND (SPIGOT X HUB)**

Used to change direction and size of pipe directly into fitting hub, usually a closet flange directly under a toilet. Works well in tight space applications on second floors.

Part #	Size	Box Qty	Box Wt
72934	4" x 3"	20	32

**90° LOWWHEEL INLET ELBOW**

(HUB X HUB X HUB)



Used to connect a branch line or vent at a change of direction in a larger vertical or horizontal pipe.

Part #	Size	Box Qty	Box Wt
73031	3" x 3" x 1½"/2"	20	24
73032	3" x 3" x 2"	20	25
73042	4" x 4" x 2"	15	35

**90° ELBOW W/SIDE INLET**

(HUB X HUB X HUB/SPIGOT)



Used to connect a branch line or vent at a change of direction in a larger vertical or horizontal pipe. The inlet is constructed to accept a 2" fitting over its outside diameter or 1½" pipe into its inside diameter.

Part #	Size	Box Qty	Box Wt
73131	3" x 3" 1½"/2"	20	24

**90° DOUBLE ELBOW (HUB X HUB X HUB)**

Ideal for "Back to Back" sink or lavatory installations.

Part #	Size	Box Qty	Box Wt
70716	1½"	50	14
70722	2" x 1½" x 1½"	20	8
70726	2"	25	12
70736	3"	10	18

**WYE (HUB X HUB X HUB)**

Used when connecting a branch line into a horizontal drain pipe. Also, can be used in conjunction with a Twist-Lok™ plug to provide a cleanout in a drain pipe.

Part #	Size	Box Qty	Box Wt
71014	1¼"	50	18
71015	1½"	25	11
71020	2"	20	13
71030	3"	20	39
71040	4"	5	18
71060	6"	1	7

**REDUCING WYE (HUB X HUB X HUB)**

Used when connecting a reducing branch line into a horizontal drain pipe. Also, can be used in conjunction with a TwistLok™ plug to provide a cleanout in a drain pipe.

\* Bushing (Part # 70221) provided to reduce to 1½".  
Bushings (Part # 70264) provided to reduce to 4".

Part #	Size	Pkg Qty	Box Qty	Box Wt
71021	2" x 2" x 1½"		20	11
71023*	2" x 1½" x 1½"		20	12
71031	3" x 3" x 1½"		20	36
71032	3" x 3" x 2"		20	27
71041*	4" x 4" x 1½"	1	10	22
71042	4" x 4" x 2"		10	21
71043	4" x 4" x 3"		10	28
71064*	6" x 6" x 4"		1	9

**DOUBLE WYE (ALL HUB)**

Used to bring two branch lines into a horizontal drain pipe.

Part #	Size	Box Qty	Box Wt
73415	1½"	20	11
73420	2"	20	15
73430	3"	10	24
73440	4"	5	21

**REDUCING DOUBLE WYE (ALL HUB)**

Used to bring two branches into a horizontal drain pipe.

Part #	Size	Box Qty	Box Wt
73421	2" x 2" x 1½" x 1½"	20	12
73431	3" x 3" x 1½" x 1½"	10	14
73432	3" x 3" x 2" x 2"	10	15
73442	4" x 4" x 2" x 2"	5	12
73443	4" x 4" x 3" x 3"	5	19

**COMBINATION TEE-WYE (HUB X HUB X HUB)**

Required in some plumbing code areas to connect a branch line into a vertical drain pipe instead of conventional tee fitting. Also, used to connect a horizontal branch pipe approaching a horizontal drain pipe on the perpendicular. (Can be made from a wye and a "Street Eighth Bend").

Part #	Size	Box Qty	Box Wt
72515	1½"	20	12
72520	2"	10	10
72530	3"	10	25
72540	4"	5	25

**REDUCING COMBINATION TEE-WYE**

(HUB X HUB X HUB)



Required in some plumbing code areas to connect a branch line into a vertical drain pipe instead of conventional tee fitting. Also, used to connect a horizontal branch pipe approaching a horizontal drain pipe on the perpendicular.

Part #	Size	Box Qty	Box Wt
72521	2" x 2" x 1½"	20	10
72531	3" x 3" x 1½"	10	12
72532	3" x 3" x 2"	10	14
72542	4" x 4" x 2"	10	16
72543	4" x 4" x 3"	5	16

**DOUBLE COMBINATION TEE-WYE (ALL HUB)**

Required in some plumbing code areas to connect two branch lines into a vertical drain pipe.

Part #	Size	Box Qty	Box Wt
72640	4" - (3 pcs)	2	15

**SANITARY TEE (HUB X HUB X HUB)**

Used when connecting a branch line into a vertical drain pipe.

Part #	Size	Box Qty	Box Wt
71114	1¼"	50	13
71115	1½"	20	7
71120	2"	20	11
71130	3"	20	33
71140	4"	10	30
71160	6"	1	6

**REDUCING SANITARY TEE**

(HUB X HUB X HUB)



Used when connecting a branch line into a vertical drain pipe.

\* Bushing (Part #70221) provided to reduce to 1½".

Part #	Size	Pkg Qty	Box Qty	Box Wt
71121	2" x 2" x 1½"		20	10
71122	2" x 1½" x 2"		20	11
71123	2" x 1½" x 1½"		20	9
71131	3" x 3" x 1½"		20	19
71132	3" x 3" x 2"		20	21
71141*	4" x 4" x 1½"	1	10	17
71142	4" x 4" x 2"		10	16
71143	4" x 4" x 3"		10	22
71164	6" x 6" x 4"		5	24

**SANITARY STREET TEE**

(SPIGOT X HUB X HUB)



Used when connecting a branch line into a vertical drain pipe.

Part #	Size	Box Qty	Box Wt
76140	4"	10	27

**DOUBLE SANITARY TEE (ALL HUB)**

Used to bring two branch lines into a vertical drain pipe.

Part #	Size	Box Qty	Box Wt
73515	1½"	20	8
73520	2"	15	11

Part #	Size	Box Qty	Box Wt
73530	3"	10	19
73540	4"	5	18

**REDUCING DOUBLE SANITARY TEE**

(ALL HUB)



Used to bring two reducing branch lines into a vertical drain pipe.

Part #	Size	Box Qty	Box Wt
73521	2" x 2" x 1½" x 1½"	15	9
73531	3" x 3" x 1½" x 1½"	10	10
73532	3" x 3" x 2" x 2"	10	13
73542	4" x 4" x 2" x 2"	5	9
73543	4" x 4" x 3" x 3"	10	24

**TEST TEE W/ CLEANOUT PLUG**

(HUB X HUB X FIP)



Used at the base of a vertical drain pipe to provide a cleanout opening flush with the finished wall. PTFE thread tape is recommended for threaded joints.

Part #	Size	Box Qty	Box Wt
71315	1½" (Threaded)	10	4
71320	2" (Threaded)	10	5
71330	3" (Toe Saver)	10	12
71340	4" (Toe Saver)	10	23

**TEST TEE (HUB X HUB X FIP)**

Used in conjunction with a threaded plug to provide a cleanout opening. PTFE thread tape is recommended for threaded joints.

Part #	Size	Box Qty	Box Wt
71416	1½"	10	3
71421	2"	10	5
71431	3"	10	12
71441	4"	10	21

**VENT TEE (HUB X HUB X HUB)**

Used primarily in seepage bed piping grids in conjunction with perforated pipe. Used where flow characteristics are not a primary consideration.

Part #	Size	Box Qty	Box Wt
71415	1½"	10	3
71420	2"	10	5
71430	3"	10	12
71440	4"	10	21

**TWO-WAY CLEANOUT TEE (HUB X HUB X HUB)**

Used with a vertical pipe. This fitting provides for above ground level access piping.

Part #	Size	Box Qty	Box Wt
71633	3"	10	22
71644	4"	5	20

**WASTE & VENT TEE W/DOUBLE SIDE INLET (ALL HUB)**

Connect 1½" or 2" vent or branch waste piping to a vertical drain pipe and receive discharge of a water closet.

\*Inlets constructed to accept 2" fitting hub over outside diameter or a 1½" pipe into their inside diameter.

Part #	Size	Pkg Qty	Box Qty	Box Wt
77031*	3" x 3" x 3" x 1½" / 2" x 1½" / 2"	1	10	17
77042	4" x 4" x 4" x 2" x 2"	1	5	16

**SANITARY TEE W/LEFT SIDE INLET (ALL HUB)**

This fitting provides for the connection of 2" vent or branch waste piping to a vertical drain pipe.

Part #	Size	Box Qty	Box Wt
77132	3" x 3" x 3" x 2"	10	17

**SANITARY TEE W/RIGHT SIDE INLET (ALL HUB)**

This fitting provides for the connection of 2" vent or branch waste piping to a vertical drain pipe.

Part #	Size	Box Qty	Box Wt
77232	3" x 3" x 3" x 2"	10	17

**FITTING CLEANOUT W/THREADED PLUG**

(SPIGOT X FIP)



Solvent welds into fitting hub to provide access to piping. PTFE thread tape is recommended for threaded joints.

Part #	Size	Pkg Qty	Box Qty	Box Wt
71615	1½"	20	100	15
71620	2"	20	100	19
71630	3"		20	11
71640	4"		10	10

**FITTING CLEANOUT BODY (SPIGOT X FIP)**

Solvent welds into fitting hub and adapts to male threaded plug. PTFE thread tape is recommended for threaded joints.

Part #	Size	Pkg Qty	Box Qty	Box Wt
71612	1¼"		50	4
71614	1½"	20	100	11
71619	2"	20	100	14
71629	3"		20	9
71639	4"		10	8
71659	6"		10	20

**THREADED PLUG (MIP)**

Used to form a removable closure. These threaded plugs offer a corrosion proof alternative to metal plugs. PTFE thread tape is recommended for threaded joints.

Part #	Size	Pkg Qty	Box Qty	Box Wt
71814	1¼"		100	4
71815	1½"	10	100	5
71820	2"	20	100	7
71830	3"	20	100	17

Part #	Size	Pkg Qty	Box Qty	Box Wt
71840	4"		10	3
71860	6"		10	7

**ADJUSTABLE P-TRAP W/UNION & CLEANOUT**

Used to prevent passage of sewer gas from the plumbing system into house through the plumbing fixture drain.

Part #	Size	Box Qty	Box Wt
78215	1½"	20	14

**ADJUSTABLE P-TRAP W/UNION**

Used to prevent passage of sewer gas from the plumbing system into house through the plumbing fixture drain.

Part #	Size	Box Qty	Box Wt
78315	1½"	20	13
78320	2"	25	20

**P-TRAP W/CLEANOUT**

Used to prevent passage of sewer gas from the plumbing system into house through the plumbing fixture drain.

Part #	Size	Box Qty	Box Wt
78415	1½"	20	13
78420	2"	20	21

**P-TRAP**

Used to prevent passage of sewer gas from the plumbing system into house through the plumbing fixture drain.

Part #	Size	Box Qty	Box Wt
78515	1½"	20	11
78520	2"	20	20
78530	3"	10	30
78540	4"	5	27

**U-BEND (HUB X HUB)**

Bottom part of trap furnished without cleanout.

Part #	Size	Box Qty	Box Wt
78015	1½"	20	9
78020	2"	20	14
78030	3"	15	27
78040	4"	10	34

**CLOSET FLANGE**

Part #	Size	Box Qty	Box Wt
75135	4" x 3" HUB	20	15

Solvent welds over 3" Sch. 40 pipe.

Part #	Size	Box Qty	Box Wt
75141	4" HUB	10	8

Solvent welds over 4" Sch. 40 pipe.

**"POP-TOP" CLOSET FLANGE**

"Pop-Top" feature prevents debris from entering plumbing system prior to setting the toilet.

Part #	Size	Box Qty	Box Wt
75134	4" x 3" HUB	20	16

Solvent welds over 3" Sch. 40 pipe.

Part #	Size	Box Qty	Box Wt
75139	4" x 3" SPIGOT	20	14

Solvent welds into 3" Sch. 40 fitting hub.

Part #	Size	Box Qty	Box Wt
75140	4" HUB	10	9

Solvent welds over 4" Sch. 40 pipe.

**CLOSET FLANGE W/METAL RING**

This flange has an adjustable metal ring which allows for easy toilet alignment and a special closet bolt holding design for easy toilet mounting.

Part #	Size	Box Qty	Box Wt
75146	4" x 3" SPIGOT	10	9

Solvent welds into 3" Sch. 40 fitting hub.

Part #	Size	Box Qty	Box Wt
75150	4" x 3" HUB	10	9

Solvent welds over 3" Sch. 40 pipe.

Part #	Size	Box Qty	Box Wt
75155	4" HUB	20	16

Solvent welds over 4" Sch. 40 pipe.

Part #	Size	Box Qty	Box Wt
75164	4" SPIGOT	10	8

Solvent welds into 4" Sch. 40 fitting hub.

**CLOSET FLANGE W/METAL RING**

This flange has an adjustable metal ring which allows for easier toilet alignment. Provides for a simple method of installing closet flange on a cement floor.

Part #	Size	Box Qty	Box Wt
75144	4"/4" x 3" SLAB	10	9

Solvent welds over 3" Sch. 40 pipe.

**OFFSET CLOSET FLANGE W/ METAL RING**

This flange has an adjustable metal ring which allows for easier toilet alignment. Used for mounting toilet base to drain pipe when pipe has been positioned incorrectly in installation.

Part #	Size	Box Qty	Box Wt
75160	4" x 3" HUB	10	10

Solvent welds over 3" Sch. 40 pipe.

**CLOSET FLANGE W/STAINLESS STEEL RING**

This flange has an adjustable stainless steel ring which allows for easy toilet alignment and a special closet bolt holding design for easy toilet mounting.

Part #	Size	Box Qty	Box Wt
75146S	4" x 3" SPIGOT	20	18

Solvent welds into 3" Sch. 40 fitting hub

Part #	Size	vBox Qty	Box Wt
75150S	4" x 3" HUB	20	18

Solvent welds over 3" Sch. 40 pipe.

**CLOSET FLANGE SPACER RING**

Used to build up existing flange when new flooring or ceramic tile has resulted in flange being at or below floor level.

Part #	Size	Box Qty	Box Wt
75154	4" HUB	25	9

**UNIVERSAL CLOSET FLANGE WITH STAINLESS STEEL RING**

Economical alternative to current mechanical closet flanges. Installs inside 4" cast iron or PVC-DWV pipe.

Part #	Size	Box Qty	Box Wt
75158S	4" HUB	10	9

**TEST CAP (SPIGOT)**

Styrene test cap fits into Sch. 40 pipe openings and is used to prevent debris from entering the plumbing system during construction.

Part #	Size	Pkg Qty	Box Qty	Box Wt
70171	1½"	25	100	1
70172	2"	25	50	1
70173	3"	25	1	1
70174	4"	20	2	2

**PVC ROOF DRAIN ASSEMBLY****(W/GRAVEL GUARD GRATE)**

For use on flat roof buildings for roof drainage. Also, for use in ground level drainage applications subject to large amounts of surface debris.

Part #	Size	Pkg Qty	Box Qty	Box Wt
71460	4" SPIGOT	1	5	18

**SHOWER DRAIN W/STAINLESS STEEL GRATE (HUB)**

For fiberglass and acrylic built-in shower applications. Includes sealing and friction gaskets for a positive seal to the shower base, and a 2" solvent weld discharge.

Part #	Size	Pkg Qty	Box Qty	Box Wt
71480	2"	1	5	14

**TOE-SAVER FLOOR PLUG**

A must for basement floor installation. Eliminates tripping hazard posed by conventional raised plugs. Interchangeable with brass or plastic plugs. PTFE thread tape is recommended for threaded joints.

Part #	Size	Pkg Qty	Box Qty	Box Wt
71853	3"	20	100	15
71854	4"		10	3

**TWIST-LOK™ PLUG (PATENT NO. 3,677,301)**

The unique Genova way of providing an easily removable closure at a Genova fitting hub. A patented Genova system feature.

Part #	Size	Pkg Qty	Box Qty	Box Wt
71871	1½"	20	100	9
71872	2"	20	100	11
71873	3"		20	8
71874	4"		10	7

**NOVAVENT® AUTOMATIC ANTI-SIPHON VALVE**

Eliminates expensive secondary vent stacks through the roof. Automatically works to prevent loss of trap seal. Made for use with sinks, basins, tubs, showers, vanities and washing machines.

Part #	Size	Box Qty	Box Wt
740151	1½" (C)	5	2
74015	1½"	5	2

**NOVAVENT® AUTOMATIC PLUMBING RELIEF VALVE**

Novavent® relief valves are for use on main plumbing vent stacks and eliminates the need for vent roof penetrations. Relief valves can be used alone or in conjunction with smaller Novavent® anti-siphon valves.

Part #	Size	Box Qty	Box Wt
740401	4" (C)	1	2

**VERTICAL EXPANSION JOINT**

To provide for expansion in straight vertical drain pipe runs exceeding 35 feet in length. 2" and 3" sizes accommodate expansion up to 1¼". 4" size accommodates expansion up to 1¾".

Part #	Size	Pkg Qty	Box Qty	Box Wt
76520	2"	1	15	10
76530	3"	1	10	16
76540	4"	1	10	31

**BACKWATER VALVE**

Solvent welds directly into PVC-DWV pipe without the need for adapters. Full size cleanout/maintenance port provided. Helps prevent sewage backup during flood conditions.

Part #	Size	Pkg Qty	Box Qty	Box Wt
77630	3"	1	4	8
77640	4"	1	2	10

## SPECIAL WASTE & VENT FITTING (DOUBLE CONFIGURATION)



Provides for the hookup of all drains from two complete bathrooms located back to back. Each unit furnished with two flush branch plugs to enable utilizing the fitting in a left or right hand drain situation. Branch inlets are 2" socket configurations to accept 2" pipe. Bushing (Part #70221) are provided to accommodate 1½" pipe.

Part #	Size	Pkg Qty	Box Qty	Box Wt
77930	3" x 1½"/2" w/3" Cap	1	5	17
77941	4" x 1½"/2" w/4" Cap	1	3	16

## SWIVEL DRUM TRAP



PVC version of the old style bathtub "Drum Trap". Largely replaced today by the conventional 1½" P-Trap (See 100 series and 700 series types).

Part #	Size	Pkg Qty	Box Qty	Box Wt
75715	1½" x 3" x 6"	1	15	19

## LOS ANGELES PATTERN P-TRAP



Used to prevent the passage of sewer gas from the plumbing system into house through the plumbing fixture drain. Used when local code doesn't permit the use of slip coupled traps.

Part #	Size	Box Qty	Box Wt
78715	1¼"/1½"	20	16

## 6" X 6" VINYL BELL TRAP



Designed to solvent weld to Sch. 40 IPS PVC. Installs easily and is direct replacement for cast bell traps. Outlet 1½" socket or 2" spigot.

Part #	Size	Pkg Qty	Box Qty	Box Wt
78860	6" x 6"	5	20	13

## 6" X 6" VINYL BELL TRAP REPLACEMENT STRAINER



Replacement for Genova's 6" x 6" Bell Trap or corroded strainers on many existing metal bell traps.

Part #	Size	Pkg Qty	Box Qty	Box Wt
78858	Fits 4½" diameter	1	10	3

## 9" X 9" VINYL BELL TRAP



Designed to solvent weld to Sch. 40 IPS PVC. Installs easily and is direct replacement for cast iron and die cast bell traps. Outlet 3" Sch. 30 socket or 3" Sch. 40 spigot.

Part #	Size	Box Qty	Box Wt
78890	9" x 9"	5	9

## 9" X 9" VINYL BELL TRAP REPLACEMENT STRAINER



Replacement for Genova's 9" x 9" Bell Trap or corroded strainers on many existing metal bell traps.

Part #	Size	Pkg Qty	Box Qty	Box Wt
78888	Fits 7¾" diameter	1	10	7

**VINYL "HUB-FIT" FLOOR STRAINER**

Prevents debris from entering a drain opening on the floor. Fits into any fitting hub. Fits flush into any fitting hub flush to the floor.

Part #	Size	Box Qty	Box Wt
79230	3"	20	5
79240	4"	20	10

**PVC PIPE FIT FLOOR STRAINER**

Prevents debris from entering a drain opening on the floor. Fits flush into any pipe flush to the floor.

Part #	Size	Box Qty	Box Wt
79120	2"	20	2
79130	3"	20	5
79140	4"	20	6

**PIPE HANGER**

(NOTE: ORDER BY THE BAG)

Incorporates a special design which allows for pipe expansion and contraction. Saddle rotates 360°. (Bulk bag contains 4 pieces.) Nails not included.

Part #	Size	Box Qty (lengths)	Box Wt
79716	1½"	25	10
79721	2"	25	11
79731	3"	25	14
79741	4"	25	16

**WYE BOSS**

Creates a permanent, disruption-free waste entrance into the main drain.

Part #	Size	Box Qty	Skid Qty	Ship Wt
72031	3" x 1½" Wye Boss	10	900	5
72032	3" x 2" Wye Boss	10	900	5
72042	4" x 2" Wye Boss	5	450	3

**TEE BOSS**

Creates a permanent, disruption-free waste entrance into the main drain.

Part #	Size	Box Qty	Skid Qty	Ship Wt
72131	3" x 1 ½" Tee Boss	10	900	4
72132	3" x 2" Tee Boss	10	900	4
72142	4" x 2" Tee Boss	5	450	3

# ABS-DWV PIPE & FITTINGS

Acrylonitrile Butadiene Styrene (ABS) pipe and fittings are used for drain, waste, and vent applications.



## ABS-DWV Pipe Cellular Core

- Meets ASTM F628
- NSF Listed

## ABS-DWV Fittings

- Meets ASTM D2661
- NSF Listed

- Pipe diameters are the same as iron pipe.
- (IPS = Iron Pipe Size)
- Solvent weld joints.

**Phone:** 800-521-7488 or (810) 744-4500  
**Fax:** (810) 744-3130  
**Email:** [inquiry@genovaproducts.com](mailto:inquiry@genovaproducts.com)  
**Hours:** 8 AM to 5 PM EST Monday - Friday

**ABS-DWV CELLULAR CORE PIPE**

Note: Be sure to order by the length not by the foot.

Part #	Size	Bdl Qty (lgths)	Skid Qty (lgths)	Bdl Wt (lbs)
80011F	1½" x 10'	5	180	14
80012F	1½" x 20'	5	90	27
80021F	2" x 10'	5	140	19
80022F	2" x 20'	5	70	37
80031F	3" x 10'	5	75	35
80032F	3" x 20'	5	50	69
80041F	4" x 10'	3	54	30
80042F	4" x 20'	3	36	60

**COUPLING (HUB X HUB)**

Used to join straight lengths of pipe.

Part #	Size	Pkg Qty	Box Qty	Box Wt
80115	1½"	20	100	8
80120	2"	20	100	12
80130	3"		20	8
80140	4"		10	7

**REPAIR COUPLING (NO STOP) (HUB X HUB)**

Furnished without center stop so that stationary lengths of pipe can be spliced together.

Part #	Size	Box Qty	Box Wt
80116	1½"	20	2
80122	2"	20	3
80133	3"	20	7
80144	4"	10	5

**REDUCING COUPLING (HUB X HUB)**

Used to reduce or increase pipe sizes.

Part #	Size	Pkg Qty	Box Qty	Box Wt
80121	2" x 1½"	20	100	12
80131	3" x 1½"		20	7
80132	3" x 2"		20	6
80142	4" x 2"		20	12
80143	4" x 3"		20	14

**CAP (HUB)**

Used for permanently or temporarily capping pipe.

Part #	Size	Pkg Qty	Box Qty	Box Wt
80151	1½"	20	100	7
80152	2"	20	100	9
80153	3"		20	6
80154	4"		10	6

**CAP (FIP)**

Used for permanently or temporarily capping pipe. Adapts to male pipe threads. PTFE thread tape is recommended for threaded joints.

Part #	Size	Box Qty	Box Wt
80161	1½"	100	6

**ADAPTER BUSHING (DWV SPIGOT X S&D HUB)**



Adapts ABS fitting hub to sewer pipe.

Part #	Size	Box Qty	Box Wt
85330	3"	50	6
85340	4"	25	4

**REDUCING BUSHING (SPIGOT X HUB)**



Inserts into fitting hub to reduce to smaller pipe size.

Part #	Size	Pkg Qty	Box Qty	Box Wt
80211	1½" x 1¼"		50	2
80221	2" x 1½"	20	100	8
80231	3" x 1½"		20	7
80232	3" x 2"		20	7
80242	4" x 2"		10	6
80243	4" x 3"		10	5

**REDUCING BUSHING (SPIGOT X FIP)**



Inserts into fitting hub to reduce to standard male pipe threads. PTFE thread tape is recommended for threaded joints.

Part #	Size	Box Qty	Box Wt
84221	2" x 1½"	65	6

**FEMALE ADAPTER (HUB X FIP)**



Adapts to standard male pipe threads. PTFE thread tape is recommended for threaded joints.

Part #	Size	Pkg Qty	Box Qty	Box Wt
80315	1½"	20	100	9
80320	2"	20	100	12
80330	3"		20	8
80340	4"		10	6

**MALE ADAPTER (HUB X MIP)**



Adapts to standard female pipe threads. PTFE thread tape is recommended for threaded joints.

Part #	Size	Pkg Qty	Box Qty	Box Wt
80411	1½" x 1¼"	20	100	7
80415	1½"	20	100	7
80420	2"	20	100	9
80430	3"		20	6
80440	4"		10	6

**SEWER PIPE ADAPTER COUPLING**

(SEWER HUB X SCH. 40 HUB)



Adapts Sch. 40 IPS pipe to 4" sewer pipe.

Part #	Size	Box Qty	Box Wt
81543	4" x 3"	20	10
81544	4" x 4"	10	5

**TRAP ADAPTER (HUB X SLIP JAMNUT)**

Utilized to adapt ABS pipe to tubular traps at wall or floor. This fitting solvent welds over 1½" DWV pipe. Sometimes called a Marvel.

Part #	Size	Pkg Qty	Box Qty	Box Wt
82211	1½" x 1¼"	20	100	12
82215	1½"	20	100	11

**FITTING TRAP ADAPTER**

(SPIGOT X SLIP JAMNUT)



Utilized to adapt ABS fitting hub to tubular traps at wall or floor. This fitting solvent welds into a DWV fitting hub. Sometimes called a Marvel.

Part #	Size	Pkg Qty	Box Qty	Box Wt
82311	1½" x 1¼"	20	100	11
82314	1¼"		50	5
82315	1½"	20	100	11

**FITTING ADAPTER (SPIGOT X MIP)**

Adapts fitting hub to standard female pipe threads. PTFE thread tape is recommended for threaded joints.

Part #	Size	Pkg Qty	Box Qty	Box Wt
82415	1½"	20	100	8
82420	2"		25	2

**SWIVEL TRAY PLUG ADAPTER (HUB X FIP)**

Used to connect laundry tray to drain.

Part #	Size	Box Qty	Box Wt
88915	1½"	80	7

**TRAY PLUG ADAPTER**

(SPIGOT X FEMALE NPSM)



Used to connect laundry tray to drain.

Part #	Size	Box Qty	Box Wt
89815	1½"	5	1

**SWIVEL TRAY PLUG (SPIGOT X FIP)**

Used to connect laundry tray to drain.

Part #	Size	Pkg Qty	Box Qty	Box Wt
89915	1½"	5	10	1

**22½° ELBOW (HUB X HUB)**



Used to change direction in piping. Sometimes called a "Sixteenth Bend".

Part #	Size	Pkg Qty	Box Qty	Box Wt
80815	1½"	20	100	11
80820	2"		20	4
80830	3"		20	12
80840	4"		10	10

**22½° STREET ELBOW (HUB X SPIGOT)**



Used to change direction in piping. Sometimes called a "Sixteenth Bend".

Part #	Size	Pkg Qty	Box Qty	Box Wt
85815	1½"	20	100	11
85820	2"		20	4
85830	3"		20	11

**45° ELBOW (HUB X HUB)**



Used to change direction in piping. Sometimes called an "Eighth Bend".

Part #	Size	Pkg Qty	Box Qty	Box Wt
83615	1½"	20	100	15
83620	2"	20	100	24
80630	3"		20	14
80640	4"		10	13

**45° STREET ELBOW (HUB X SPIGOT)**



Used to change direction from a fitting hub to pipe. Sometimes called a "Street Eighth Bend".

Part #	Size	Pkg Qty	Box Qty	Box Wt
82715	1½"	20	100	15
82720	2"	20	100	24
82730	3"		20	14
82740	4"		10	13

**60° ELBOW (HUB X HUB)**



Used to change direction in piping. Sometimes called a "Sixth Bend".

Part #	Size	Pkg Qty	Box Qty	Box Wt
80915	1½"	20	100	14
80920	2"		20	5
80930	3"		20	13
80940	4"		10	12

**90° SANITARY ELBOW (HUB X HUB)**



Used to change direction in piping. Sometimes called a "Quarter Bend".

Part #	Size	Pkg Qty	Box Qty	Box Wt
82815	1½"	20	100	18
82820	2"	20	100	29
82830	3"		20	19
82840	4"		10	15

**90° VENT ELBOW (HUB X HUB)**

Used to change direction in the "dry" portion of vent piping where water flow is not a consideration. Sometimes called a "Short Turn Quarter Bend".

Part #	Size	Pkg Qty	Box Qty	Box Wt
80715	1½"	20	100	16
80720	2"		20	4
80730	3"		20	14

**90° SANITARY STREET ELBOW**

(HUB X SPIGOT)



Used to change direction from a fitting hub to a pipe. Sometimes called a "Street Quarter Bend".

Part #	Size	Pkg Qty	Box Qty	Box Wt
82916	1½"	20	100	18
82926	2"		20	6
82936	3"		20	17
82946	4"		10	15

**REDUCING CLOSET BEND (HUB X HUB)**

Used to change direction in piping as well as size. Usually utilized to convert from 3" horizontal pipe to 4" vertical pipe directly under the toilet.

Part #	Size	Box Qty	Box Wt
82834	4" x 3"	20	23

**REDUCING CLOSET BEND (SPIGOT X HUB)**

Used to change direction in piping as well as size. Usually utilized to convert from 3" horizontal pipe to 4" fitting hub directly under the toilet.

Part #	Size	Box Qty	Box Wt
82934	4" x 3"	10	11

**REDUCING CLOSET BEND W/TEST CAP**

(SPIGOT X HUB)



Used to change direction in piping as well as size. Usually utilized to convert from 3" horizontal pipe to 4" fitting hub directly under the toilet.

Part #	Size	Box Qty	Box Wt
82935	4" x 3"	10	11

**90° LONG SWEEP ELBOW (HUB X HUB)**

Used to change direction in piping. Sometimes called a "Long Turn Quarter Bend".

Part #	Size	Pkg Qty	Box Qty	Box Wt
83815	1½"	20	100	24
83820	2"	20	80	26
83830	3"		20	21
83840	4"		10	18

**90° ELBOW W/SIDE INLET**

(HUB X HUB X HUB)



Connects a branch line or vent at a change of direction in a larger vertical or horizontal drain pipe.

Part #	Size	Box Qty	Box Wt
83132	3" x 3" x 2"	20	18

**90° ELBOW W/LOWHEEL INLET**

(HUB X HUB X HUB)



Connects a branch line or vent at a change of direction in a larger vertical or horizontal pipe.

Part #	Size	Box Qty	Box Wt
83032	3" x 3" x 2"	20	19
83042	4" x 4" x 2"	10	15

**WYE (HUB X HUB X HUB)**



Used when connecting a branch line into a horizontal drain pipe.

Part #	Size	Box Qty	Box Wt
81015	1½"	25	8
81020	2"	20	10
81030	3"	20	27
81040	4"	5	14

**REDUCING WYE (HUB X HUB X HUB)**



Used when connecting a branch line into a horizontal drain pipe. Reduces to smaller pipe size.

Part #	Size	Box Qty	Box Wt
81021	2" x 2" x 1½"	20	9
81023	2" x 1½" x 1½"	20	8
81031	3" x 3" x 1½"	20	18
81032	3" x 3" x 2"	20	19
81042	4" x 4" x 2"	10	15
81043	4" x 4" x 3"	10	21

**DOUBLE WYE (ALL HUB)**



Used to bring two branch lines into a horizontal drain pipe.

Part #	Size	Box Qty	Box Wt
83415	1½"	25	11
83420	2"	20	13
83430	3"	10	19
83440	4"	5	17

**COMBINATION TEE-WYE (HUB X HUB X HUB)**



Used in some plumbing code areas to connect a branch line into a vertical drain pipe instead of a conventional tee fitting. Also, is the acceptable method of connecting a horizontal branch pipe approaching a horizontal drain pipe on the perpendicular.

Part #	Size	Box Qty	Box Wt
82515	1½"	20	8
82520	2"	10	7
82530	3"	10	19
82540	4"	5	19

**REDUCING COMBINATION TEE-WYE**

(HUB X HUB X HUB)



Used in some plumbing code areas to connect a reducing branch line into a vertical drain pipe instead of a conventional tee fitting. Also, is the acceptable method of connecting a horizontal branch pipe approaching a horizontal drain pipe on the perpendicular.

(Can be made from a wye and a "Street Eighth Bend").

Part #	Size	Box Qty	Box Wt
82521	2" x 2" x 1½"	10	4
82531	3" x 3" x 1½"	10	11
82532	3" x 3" x 2"	10	11
82542	4" x 4" x 2"	10	14
82543	4" x 4" x 3"	5	13

**SANITARY TEE (HUB X HUB X HUB)**

Used when connecting a branch line into a vertical drain pipe.

Part #	Size	Box Qty	Box Wt
81115	1½"	20	5
81120	2"	20	8
81130	3"	20	25
81140	4"	10	21

**SANITARY TEE (SPIGOT X HUB X HUB)**

Used when connecting a branch line into a vertical drain pipe.

Part #	Size	Box Qty	Box Wt
86115	1½"	50	11
86120	2"	20	6
86130	3"	10	10

**REDUCING SANITARY TEE**

(HUB X HUB X HUB)



Used when connecting a reducing branch line into a vertical drain pipe.

Part #	Size	Box Qty	Box Wt
81123	2" x 1½" x 1½"	50	15
81122	2" x 1½" x 2"	20	8
81121	2" x 2" x 1½"	20	7
81131	3" x 3" x 1½"	20	14
81132	3" x 3" x 2"	20	16
81142	4" x 4" x 2"	10	12
81143	4" x 4" x 3"	10	17

**DOUBLE FIXTURE TEE (ALL HUB)**

Used in some plumbing code areas to connect two branch lines into a vertical drain pipe.

Part #	Size	Box Qty	Box Wt
82620	2"	20	12

**REDUCING DOUBLE FIXTURE TEE (ALL HUB)**

Used in some plumbing code areas to connect a reducing branch line into a vertical drain pipe.

Part #	Size	Box Qty	Box Wt
82621	2" x 1½" x 1½" x 1½"	25	10

**DOUBLE SANITARY TEE (ALL HUB)**



Used to bring two branch lines into a vertical drain pipe.

Part #	Size	Box Qty	Box Wt
83515	1½"	20	6
83520	2"	15	8
83530	3"	10	15
83540	4"	5	14

**REDUCING DOUBLE SANITARY TEE**

(ALL HUB)



Used to bring two branch lines into a vertical drain pipe.

Part #	Size	Box Qty	Box Wt
83521	2" x 2" x 1½" x 1½"	15	7
83531	3" x 3" x 1½" x 1½"	10	8
83532	3" x 3" x 2" x 2"	10	10

**TEST TEE W/CLEANOUT PLUG**

(HUB X HUB X FIP)



Used at the base of a vertical drain pipe to provide a cleanout opening flush with the finished wall. PTFE thread tape is recommended for threaded joints.

Part #	Size	Box Qty	Box Wt
81315	1½"	10	3
81320	2"	10	4
81340	4"	10	19

**TEST TEE (HUB X HUB X FIP)**



Used in conjunction with a threaded plug to provide a cleanout opening. PTFE thread tape is recommended for threaded joints.

Part #	Size	Box Qty	Box Wt
81416	1½"	10	3
81421	2"	10	4
81431	3"	10	8
81441	4"	10	16

**TWO-WAY CLEANOUT TEE**

(HUB X HUB X HUB)



Used with vertical drain pipe stack, this fitting provides for above ground level access to piping.

Part #	Size	Box Qty	Box Wt
81633	3"	10	16
81644	4"	5	15

**VENT TEE (HUB X HUB X HUB)**



Used primarily in vent lines. Used where flow characteristics are not a primary consideration.

Part #	Size	Box Qty	Box Wt
81415	1½"	10	3
81420	2"	10	3
81430	3"	10	10
81440	4"	10	20

**FITTING CLEANOUT BODY (SPIGOT X FIP)**

Conventional threaded cleanout fitting solvent welds into fitting hub and adapts to male threaded plug. PTFE thread tape is recommended for threaded joints.

Part #	Size	Pkg Qty	Box Qty	Box Wt
81614	1½"	20	100	10
81619	2"	20	100	11
81629	3"		20	7
81639	4"		10	6

**FITTING CLEANOUT W/THREADED PLUG (SPIGOT X FIP)**

Solvent welds into fitting hub to provide access to piping. PTFE thread tape is recommended for threaded joints.

Part #	Size	Pkg Qty	Box Qty	Box Wt
81615	1½"	20	100	14
81620	2"	20	100	17
81630	3"		25	13
81640	4"		10	9

**SNAP-IN CLEANOUT W/PLUG**

Fitting fits into Sch. 40 DWV pipe and is used to provide access to piping.

Part #	Size	Box Qty	Box Wt
89340	4"	10	4

**THREADED PLUG (MIP)**

Used to form a removable closure. These threaded plugs offer a corrosion proof alternative to metal plugs. PTFE thread tape is recommended for threaded joints.

Part #	Size	Pkg Qty	Box Qty	Box Wt
81814	1¼"	20	100	3
81815	1½"	20	100	5
81820	2"	20	100	7
81830	3"	20	100	17
81835	3½"		20	5
81840	4"		10	3

**COUNTER SUNK PLUG (MIP)**

Used to form a removable flush closure. PTFE thread tape is recommended for threaded joints.

Part #	Size	Box Qty	Box Wt
81851	1½"	50	2
81852	2"	50	3
81853	3"	75	9
81854	4"	25	6

**SLIP JOINT NUT (FIP)**

Interchanges with metal or plastic and offers a corrosion proof alternative to metal nuts.

Part #	Size	Pkg Qty	Box Qty	Box Wt
84715	1½"	25	50	2

**ADJUSTABLE P-TRAP W/UNION**



Used to prevent passage of sewer gas from the plumbing system into house through the plumbing fixture drain.

Part #	Size	Pkg Qty	Box Qty	Box Wt
88314	1¼"	10	50	19
88315	1½"		20	9
88320	2"		20	16

**P-TRAP W/CLEANOUT**



Used to prevent passage of sewer gas from the plumbing system into house through the plumbing fixture drain.

Part #	Size	Box Qty	Box Wt
88415	1½"	50	22
88420	2"	10	8

**P-TRAP**



Used to prevent passage of sewer gas from the plumbing system into house through the plumbing fixture drain.

Part #	Size	Box Qty	Box Wt
88515	1½"	20	8
88520	2"	20	15
88530	3"	10	21
88540	4"	5	20

**LOS ANGELES P-TRAP**



Used to prevent the passage of sewer gas from the plumbing system into house through the plumbing fixture drain. Used when local code doesn't permit the use of slip coupled traps.

Part #	Size	Box Qty	Box Wt
88715	1¼"/1½"	20	11

**U-BEND W/CLEANOUT (HUB X HUB)**



Bottom part of trap furnished with cleanout

Part #	Size	Box Qty	Box Wt
88115	1½"	50	15

**CLOSET FLANGE**



Part #	Size	Box Qty	Box Wt
85135	4" x 3" HUB	20	13

Solvent welds over 3" Sch. 40 pipe.

Part #	Size	Box Qty	Box Wt
85141	4" HUB	10	6

Solvent welds over 4" Sch. 40 pipe.

**CLOSET FLANGE W/GUSSETS**



Solvent welds over 4" Sch. 40 pipe.

Part #	Size	Box Qty	Box Wt
85133	4" HUB	35	19

**"POP-TOP" CLOSET FLANGE**

Solvent welds over 3" Sch. 40 pipe. Unique "Pop-Top" feature prevents debris from entering plumbing system prior to setting the toilet.

Part #	Size	Pkg. Qty.	Box Qty	Box Wt
85134	4" x 3"	HUB	20	14

**CLOSET FLANGE**

Adapts to standard male pipe threads.

Part #	Size	Box Qty	Box Wt
85136	4" x 3" FIP	20	11

**CLOSET FLANGE W/METAL RING**

These flanges have an adjustable metal ring which allows for easy toilet alignment.

Part #	Size	Box Qty	Box Wt
85146	4" x 3" SPIGOT	10	8

Solvent welds into 3" Sch. 40 fitting hub.

Part #	Size	Box Qty	Box Wt
85150	4" x 3" HUB	10	8

Solvent welds over 3" Sch. 40 pipe.

Part #	Size	Box Qty	Box Wt
85155	4" HUB	25	19

Solvent welds into 4" Sch. 40 pipe.

Part #	Size	Box Qty	Box Wt
85164	4" SPIGOT	25	24

Solvent welds into 4" Sch. 40 fitting hub.

**CLOSET FLANGE-FLUSH FIT**

Solvent welds over 3" Sch. 40 pipe.

Part #	Size	Box Qty	Box Wt
85166	4" x 3" HUB	10	6

**OFFSET CLOSET FLANGE W/ METAL RING**

This flange has an adjustable metal ring which allows for easier toilet alignment. Solvent welds over 3" Sch. 40 pipe.

Part #	Size	Box Qty	Box Wt
85160	4" x 3" HUB	10	11

**UNIVERSAL CLOSET FLANGE WITH STAINLESS STEEL RING**

Economical alternative to current mechanical closet flanges. Installs inside 4" cast iron or ABS-DWV pipe.

Part #	Size	Box Qty	Box Wt
85158S	4" HUB	10	8

**BACKWATER VALVE**

Solvent welds directly into ABS-DWV pipe without the need for adapters. Full size cleanout/maintenance port provided. Helps prevent sewage backup during flood conditions.

Part #	Size	Pkg Qty	Box Qty	Box Wt
87630	3"	1	4	8
87640	4"	1	2	9

## NON-NSF POLYETHYLENE PIPE



Part #	Size	Pressure Rating at 73°F (PSI)	Coil Qty	Coil Wt (lbs)
911051	½" x 100'	100	1	5
911052	½" x 400'	100	1	20
911071	¾" x 100'	100	1	7
911072	¾" x 400'	100	1	26
911101	1" x 100'	100	1	9
911102	1" x 300'	100	1	27
911111	1¼" x 100'	100	1	15
911112	1¼" x 300'	100	1	44
911121	1½" x 100'	100	1	20
911122	1½" x 300'	100	1	59
911221	2" x 100'	100	1	33
911222	2" x 200'	100	1	65

## NSF APPROVED POLYETHYLENE PIPE

(ASTM D-2239, PE 3408)



Part #	Size	Pressure Rating at 73°F (PSI)	Coil Qty	Coil Wt (lbs)
910073	¾" x 25'	100	1	2
910074	¾" x 50'	100	1	4
910071	¾" x 100'	100	1	8
910072	¾" x 400'	100	1	30
910103	1" x 25'	100	1	3
910104	1" x 50'	100	1	6
910101	1" x 100'	100	1	11
910102	1" x 300'	100	1	33
910113	1¼" x 25'	100	1	5
910114	1¼" x 50'	100	1	9
910111	1¼" x 100'	100	1	19
910112	1¼" x 300'	100	1	56
910121	1½" x 100'	100	1	25
910122	1½" x 300'	100	1	77
910221	2" x 100'	100	1	42

Part #	Size	Pressure Rating at 73°F (PSI)	Coil Qty	Coil Wt (lbs)
910222	2" x 200'	100	1	84
912071	¾" x 100'	125	1	9
912101	1" x 100'	125	1	15
912102	1" x 300'	125	1	43
912112	1¼" x 300'	125	1	75
912121	1½" x 100'	125	1	32
910053	½" x 25'	160	1	2
910054	½" x 50'	160	1	3
912051	½" x 100'	160	1	6
912052	½" x 400'	160	1	23
916071	¾" x 100'	160	1	12
916072	¾" x 300'	160	1	35
916101	1" x 100'	160	1	19
916102	1" x 300'	160	1	57
916111	1¼" x 100'	160	1	33
916112	1¼" x 300'	160	1	97
920071	¾" x 100'	200	1	16
920101	1" x 100'	200	1	25
920111	1¼" x 100'	200	1	42

**CHECK VALVE (MIP X POLY INSERT)**

Used to prevent discharge line backflow into sump pit. Prevents sump pump "short cycling". Made to adapt directly to 1½" solvent weld fittings or 1¼" flexible polyethylene.

Part #	Size	Pkg Qty	Box Qty	Box Wt
96610	1¼" x 1¼"	5	20	6

**UNIVERSAL CHECK VALVE**

Each individually merchandised packaged valve provides easy installation instructions. The valves are truly universal; provided with two adapter hoses and necessary stainless clamps, they will fit the full range of pipe sizes from 1¼" polyethylene to 1½" iron or plastic.

Part #	Box Qty	Box Wt
966311	10	9

Check valves are available from the factory in box quantities only.

**90° ELBOW**



Part #	Size	Pkg Qty	Box Qty	Box Wt
11180	1¼"	1	100	26
11181	1½"	1	100	19

**90° 3-WAY ELBOW**



Part #	Size	Pkg Qty	Box Qty	Box Wt
11182	1"	1	200	31
11183	1¼"	1	100	19
11184	1½"	1	100	16
11185	2"	1	30	17

**TEE**



Part #	Size	Pkg Qty	Box Qty	Box Wt
11186	1¼"	1	100	24

**90° 4-WAY TEE**



Part #	Size	Pkg Qty	Box Qty	Box Wt
11188	1"	1	100	20
11189	1¼"	1	100	18
11190	1½"	1	75	34

**CROSS**



Part #	Size	Pkg Qty	Box Qty	Box Wt
11191	1¼"	1	75	21
11192	1½"	1	75	32

**5-WAY CROSS**



Part #	Size	Pkg Qty	Box Qty	Box Wt
11307	1"	1	75	19
11308	1¼"	1	50	23

Note: The fittings above are for creating pipe furniture only and are not for use in any other plumbing applications. Any Genova product used other than for its intended purpose will not be covered by warranty.



# RAINGO<sup>®</sup> & REPLA K<sup>®</sup>

Vinyl gutter and downspout systems provide durable and low maintenance alternatives to traditional aluminum systems.



- U-shaped and traditional K-style appearance
- Snap together and leak-proof sealant installation
- Durable & maintenance-free
- Patented ridges to enhance performance
- Solvent weld joints.

Phone: 1-800-521-7488 or (810) 744-4500

Fax: (810) 744-3130

Email: [inquiry@genovaproducts.com](mailto:inquiry@genovaproducts.com)

Hours: 8 AM to 5 PM EST Monday - Friday

# Vinyl Gutter & Downspout

# RAINGO®

part #	size	pkg. qty.	box qty.	skid qty.	box wt.	part #	size	pkg. qty.	box qty.	skid qty.	box wt.
--------	------	-----------	----------	-----------	---------	--------	------	-----------	----------	-----------	---------

## GUTTER (10' lengths)

 RW100		10	480	38	
RB100		10	480	38	

5" U-shaped gutter has patented ridges to resist clogging by ice and/or debris.

## INSIDE END CAP

 RW101		5	50	7500	5
RB101		5	50	7500	5

Used with a gutter fitting to make a gutter end either right or left.

## OUTSIDE END CAP

 RW102		10	50	4000	8
RB102		10	50	4000	8

Used to make a gutter end either right or left. Provided with Raingo® seals.

## GUTTER CORNER

 RW103		5	20	600	10
RB103		5	20	600	10

Used for either an inside or outside 90° corner. This support fitting is designed with seals and fitting marks that indicate the correct gutter placement to allow for expansion and contraction.

## CUSTOM GUTTER CORNER

 RW103S		1			
RB103S		1			

Genova will make a custom corner to fit any angle. Please specify the angle when ordering.

## GUTTER DROP OUTLET

 RW104		5	20	720	9
RB104		5	20	720	9

Used to connect Raingo® gutter with Raingo® downspout. This support fitting is designed with Raingo® seals and fitting marks that indicate the correct placing of gutter to give required expansion allowance.

## HIGHFLO® DROP OUTLET

 HRW107		5	480	4	
HRB107		5	480	4	

Highflo® Drop Outlet increases the gutter capacity and discharge rate of rainwater. This part is a patented feature exclusive to the Raingo® system and improves its overall efficiency.

## RAINGO® TO DURASPOUT® DROP OUTLET

 A-STYLE RW144A	2"x3"	5	20	720	9
RB144A	2"x3"	5	20	720	9

 B-STYLE RW144B	2"x3"	5	20	720	9
RB144B	2"x3"	5	20	720	9

Connects Raingo® gutter with Duraspout® Downspout. This support fitting is designed with Raingo® seals and fitting marks that indicate the correct placing of the gutter to give required expansion allowance.

## GUTTER SLIP JOINT

 RW105		10	50	1800	14
RB105		10	50	1800	14

Used for joining two pieces of gutter. This support fitting is designed with Raingo® seals and fitting marks that indicate the correct placement of the gutter to allow for expansion and contraction.

## HEAVY LOAD GUTTER BRACKET

 RW106H		25	100	3600	12
RB106H		25	100	3600	12

Used to support gutter. Recommended spacing every 30".

## ALL PURPOSE SEAL LUBRICANT

 RW206	1oz.	10	3780	3	
---	------	----	------	---	--

Used as a lubricant for neoprene seals found on Raingo® gutter fittings to ease the installation and allow for movement caused by expansion and contraction.

RW = White RB = Brown

# Vinyl Gutter & Downspout

**RAINGO®**

part #	size	pkg. qty.	box qty.	skid qty.	box wt.	part #	size	pkg. qty.	box qty.	skid qty.	box wt.
--------	------	-----------	----------	-----------	---------	--------	------	-----------	----------	-----------	---------

## GUTTER STRAP HANGER

 HRW108 50 10500 10  
Used where fascia board does not exist or is not vertical. Attaches to roof under shingles. Connected to support brackets and slip joints with Raingo® screws.

## GUTTER GUARD

 RW113 (3' lengths) 25 525 9  
RW115 (5' lengths) 20 420 11  
For use with any symmetrical gutter system, such as Raingo®, to prevent leaves and other debris from entering the gutter system. Non-metallic.

## DOWNSPOUT (10' lengths)

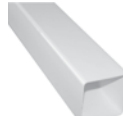
 RW200 2½" x 2½" 10 210 49  
RB200 2½" x 2½" 10 210 49  
Connects to Raingo® gutter system.

## STANDARD DOWNSPOUT ELBOW

 RW201 10 20 900 7  
RB201 10 20 900 7  
Used where the downspout changes in any direction. Turns 112° for offsets and discharge spouts.

## 90° DOWNSPOUT ELBOW

 RW209 10 20 1120 4  
RB209 10 20 1120 4  
Used where the downspout changes in any direction. Turns 92½° for offsets and discharge spouts.

## DOWNSPOUT BRACKET

 RW202 25 50 4000 4  
RB202 25 50 4000 4  
Used to support downspout at every offset elbow, coupler, and discharge spout.

## DOWNSPOUT COUPLER

 RW203 5 20 2400 5  
RB203 5 20 2400 5  
Used in joining two lengths of downspout.

## DOWNSPOUT ADAPTER

 RW207 4" 5 10 1200 4  
RB207 4" 5 10 1200 4  
Adapts Raingo® downspout to 4" plastic sewer pipe or 4" Sch. 40 DWV fittings.

## LEAFGO® DEBRIS SEPARATOR

 HRW208 5 400 4  
HRB208 5 400 4  
Helps prevent leaves from clogging gutters. This part is a patented feature exclusive to the Raingo® system.

## DOWNSPOUT BUSHING

 RW215 25 50 6000 4  
Reduces size of downspout elbow to fit over drop outlet opening.

## SPLASHBLOCK

 RW250 10 140 18  
RB250 10 140 18  
Used to guard against foundation water damage from run-off seepage. Hinged design makes mowing and trimming easy. Fits Raingo® downspouts.

RW = White RB = Brown

# Vinyl Gutter

# REPLA K

part #	size	pkg. qty.	box qty.	skid qty.	box wt.	part #	size	pkg. qty.	box qty.	skid qty.	box wt.
--------	------	-----------	----------	-----------	---------	--------	------	-----------	----------	-----------	---------

## GUTTER (10' lengths)



AW100K		10	420	45
AB100K		10	420	45

A complete gutter system resembling seamless aluminum systems. Has patented ridges to reduce clogging by debris or ice.

## RIGHT END CAP



AW101K		5	20	3840	3
AB101K		5	20	3840	3

Used for each right end of the gutter run.

## LEFT END CAP



AW102K		5	20	3840	3
AB102K		5	20	3840	3

Used for each left end of the gutter run.

## INSIDE 90° GUTTER CORNER



AW103AK		5	10	350	7
AB103AK		5	10	350	7

Used for inside 90° corner.

## OUTSIDE 90° GUTTER CORNER



AW103BK		5	10	350	6
AB103BK		5	10	350	6

Used for outside 90° corner.

## CUSTOM GUTTER CORNER

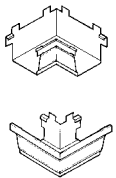

AW103AS		1			
AB103AS		1			
AW103BS		1			
AB103BS		1			

Genova will make a custom corner to fit any angle. Please specify angle when ordering.

## GUTTER DROP OUTLET



AW104	2"x3"	5	10	350	10
AB104	2"x3"	5	10	350	10
AW104CK	3"x4"	5	10	350	10
AB104CK	3"x4"	5	10	350	10

Connects gutter with Duraspout® downspout run.

## GUTTER CONNECTOR



AW105K		5	20	1120	5
AB105K		5	20	1120	5

Used for joining two pieces of gutter.

## GUTTER BRACKET



AW106		25	50	6000	5
AB106		25	50	6000	5

Used for support of gutter. Brackets cannot be seen at ground level.

## GUTTER STRAP HANGER



AW108		50	10500	10
-------	--	----	-------	----

Used where fascia board does not exist or is not vertical. Attaches to roof under shingles. Connects to gutter brackets with Genova screws.

## DEBRIS SHIELD™



AW115	(5' lengths)	20	1080	11
-------	--------------	----	------	----

For use with Repla K® and standard metal gutter systems to prevent leaves and other debris from entering the gutter system. Non-metallic.

## VINYL SEALANT - CLEAR



AW945	4½ oz.	18	864	8
-------	--------	----	-----	---

Connects Repla K® gutter to gutter fittings.

# Vinyl Downspout

**DuraSpout®**

part #	size	pkg. qty.	box qty.	skid qty.	box wt.	part #	size	pkg. qty.	box qty.	skid qty.	box wt.
--------	------	-----------	----------	-----------	---------	--------	------	-----------	----------	-----------	---------

## DURASPOUT® DOWNSPOUT (10' lengths)

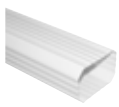

AW200	2"x3"	10	210	27
AB200	2"x3"	10	210	27
AW300	3"x4"	5	135	22
AB300	3"x4"	5	135	22

This vinyl replica of aluminum downspout installs directly onto metal systems; no adapters needed! Can also be installed as a stand-alone system.

## DOWNSPOUT ELBOW - A-STYLE



AW201A	2"x3"	10	600	3
AB201A	2"x3"	10	600	3
AW301A	3"x4"	5	300	3
AB301A	3"x4"	5	300	3

This vinyl replica of aluminum downspout elbows installs directly onto metal systems or can be installed with the Repla K system, where the downspout changes in any direction. Turns 112° for offsets and discharge spouts.

## DOWNSPOUT ELBOW - B-STYLE



AW201B	2"x3"	10	720	3
AB201B	2"x3"	10	720	3
AW301B	3"x4"	5	300	3
AB301B	3"x4"	5	300	3

This vinyl replica of aluminum downspout elbows installs directly onto metal systems or can be installed with the Repla K system, where the downspout changes in any direction. Turns 112° for offsets and discharge spouts.

## DOWNSPOUT ELBOW - A TO B-STYLE



AW221	2"x3"	10	600	3
AB221	2"x3"	10	600	3
AW321	3"x4"	5	300	3
AB321	3"x4"	5	300	3

Used with a B-Style Elbow to create an offset on side of house.

## DOWNSPOUT BRACKET



AW202	2"x3"	25	50	4000	2
AB202	2"x3"	25	50	4000	2
AW302	3"x4"	25	50	2800	3
AB302	3"x4"	25	50	2800	3

Used to mount elbows and couplers to the house.

## DOWNSPOUT COUPLER



AW203	2"x3"	5	20	1600	4
AB203	2"x3"	5	20	1600	4
AW303	3"x4"	9	2268	2	
AB303	3"x4"	9	2268	2	

Connects two lengths of downspout.

## DOWNSPOUT ADAPTER



45234	2"x3"x4"	10	1200	5
45344	3"x4"x4"	10	560	5

Used to connect rain gutter downspouts to underground sewer piping.

## OFFSET DOWNSPOUT ADAPTER



46234	2"x3"x4"	10	560	5
46344	3"x4"x4"	10	560	5

Used to connect rain gutter downspouts to underground sewer piping.

## ADJUST-A-SPOUT SPLASHBLOCK



AW475	2"x3" or 3"x4"	12	144	27
AB475	2"x3" or 3"x4"	12	144	27

Used to guard against foundation water damage from run-off seepage. Extends up to 6', swivels 180° and flips up for easy trimming and mowing.

## SPLASHBLOCK - A-STYLE



RW400	2"x3"	10	140	19
RB400	2"x3"	10	140	19

Used to guard against foundation water damage from run-off seepage. Hinged design makes mowing and trimming easy. Fits standard 2"x3" systems with A-style elbows.

AW = White AB = Brown

Genova Products

# Vinyl Downspout

**DuraSpout®**

part #

size

pkg. box  
qty. qty.

skid box  
qty. wt.

part #

size

pkg. box  
qty. qty.

skid box  
qty. wt.

## SPLASHBLOCK - B-STYLE



RW450 2"x3" 10 140 19

RB450 2"x3" 10 140 19

Used to guard against foundation water damage from run-off seepage. Hinged design makes mowing and trimming easy. Fits standard 2"x3" systems. Adapter is turned 90° to be used w/B-style elbows.

# Vinyl Gutter & Downspout

# Accessories

part #	pkg. qty.	box qty.	skid qty.	box wt.	part #	pkg. qty.	box qty.	skid qty.	box wt.
--------	-----------	----------	-----------	---------	--------	-----------	----------	-----------	---------

## RUST-RESISTANT SCREW (ORDER BY THE BAG)



RW205 25/bag 10 50 8100 10

Used for mounting brackets and fittings on Raingo® and Repla K® systems.

## GUTTER BRACKET SPACER (ORDER BY THE BAG)



RW112 5/bag 6 1440 2  
RB112 5/bag 6 1440 2

Designed to compensate for the slope in roofs constructed with non-vertical fascia or no fascia. Can be installed directly on end of roof rafter. For Genova Raingo® & Repla K® systems (6/12 pitch for Repla K® only.)

## DRIP EDGE



**White**  
19553 (5' lengths) 25 1050 12  
19563 (10' lengths) 25 1600 23  
**Brown**  
19554 (5' lengths) 25 1050 12  
19564 (10' lengths) 25 1600 23

Slips under shingles on roofs that do not have sufficient shingle overhang to direct rainwater into gutters.

## GUTTER SCOOP



19570 15 720 5  
All purpose scoop, excellent to clean out gutters and more.

## UNIVERSAL SPLASHBLOCK



19580 Slate 12 144 30  
19581 Green 12 144 30  
19582 Brown 12 144 30  
19583 Gray 12 144 30



Used to guard against foundation water damage from run-off seepage. Can be used with any type of downspout. Leaf design compliments your outdoor landscaping.

## GENO-FLEX UNIVERSAL DOWNSPOUT EXTENDER



AW575 White 16 192 14  
AB575 Brown 16 192 14  
AG575 Green 16 192 14  
AT575 Tan 16 192 14

Used to divert water away from foundation; prevents erosion. Installs without tools; bendable, flexible; expands from 19" to 55". Fits 2"x3" or 3"x4" downspouts.

# Custom Gutter Corner Fabrication Service

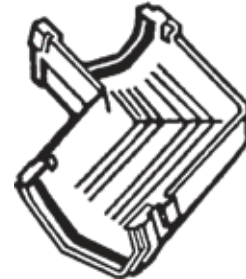
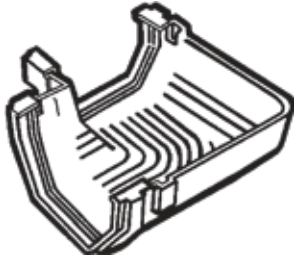

Occasionally there arises a need for a gutter corner with an angle other than the standard 90°. Bay windows, for example, require four 135° corners. Genova has established a service to custom fabricate gutter corners, for the Raingo® and Repla K® systems to any angle between 90° and 180°.

To order a custom gutter corner, simply provide the following information and mail it along with payment.

- Allow 2 weeks to process your order -

- RW103S (White Raingo® Corner) \$36.99
- RB103S (Brown Raingo® Corner) \$36.99
- AW103AS (White Repla K® Inside Corner) \$36.99
- AB103AS (Brown Repla K® Inside Corner) \$36.99
- AW103BS (White Repla K® Outside Corner) \$36.99
- AB103BS (Brown Repla K® Outside Corner) \$36.99

Michigan residents add 6% state sales tax

Name: \_\_\_\_\_

Address: \_\_\_\_\_

City: \_\_\_\_\_ State: \_\_\_\_\_ ZIP: \_\_\_\_\_

Phone: \_\_\_\_\_ - \_\_\_\_\_ - \_\_\_\_\_

VISA  MasterCard  American Express  Check

Credit Card # \_\_\_\_\_

CVV# \_\_\_\_\_ Expiration Date \_\_\_\_ / \_\_\_\_

The Card Verification Value (CVV) is a 3-digit number found on the signature panel on the back of your credit card. It is an additional safeguard that helps us validate your purchase and protect against fraud. It is not contained in the magnetic stripe information and is therefore not printed on sales receipts.

Authorized Signature: \_\_\_\_\_

\*Shipping Charges: 1st Corner \$9 Each additional \$2 each

To order gutter corners of different angles, provide a sketch of the roofline with angles marked.

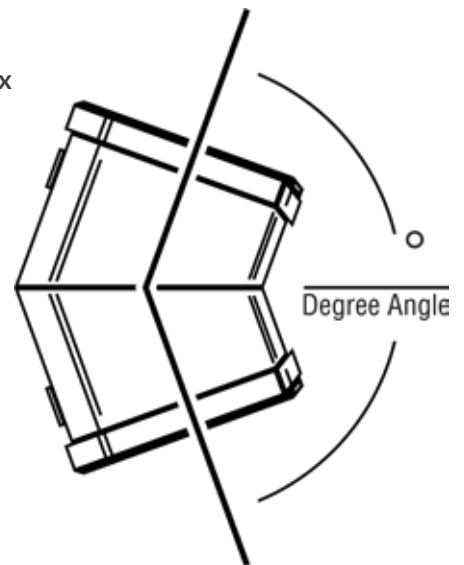

Quantity Ordered

**Genova Products, Inc.**  
**7034 E Court St**  
**Davison, MI 48423**

# Boji

## MARINE/RV FILTER/SOFTENER



The Boji Marine/RV Filter/Softener is constructed of the finest thermoplastic materials and should provide a lifetime of trouble free use. There are no moving parts to wear out and the softener is resistant to all corrosive environments encountered in boating. The unit is designed to soften your dockside water supply, providing you with generous amounts of soft water for drinking, bathing and washing your boat or RV.

The Boji Marine/RV Filter/Softener can be installed in-line for dockside pressure water supply or can be used to fill your vessel's or RV's inboard water storage tank. As a result water suds easier, is less corrosive to inboard plumbing and minimizes unsightly stains and water spots. The Boji Marine/RV Filter/Softener is also an indispensable aid in washing your boat or RV. Say good-bye to difficult to remove deposits on bright work and

windows.

The Boji Marine/RV Filter/Softener works in the same manner as a commercial manually operated water conditioner. There are not any time clocks, solenoids or directional valves to malfunction. No external power source is required. The unit is simply installed between the water supply hoses. When water is turned on, water flows through the softener, softening as it goes. That's all there is to it!

Depending on the hardness of the water supply source, your Boji will require periodic regeneration to maintain its water softening capabilities. This is easily done utilizing a canister type water filtration unit and pure pelletized water softener salt cubes, available from a variety of local sources.

**BOJI PACKAGES****REGULAR CAPACITY SYSTEM**

Includes:

- Standard Boji      - Activated Carbon Filter Cartridge
- Prefilter Housing w/Clear Canister      - 36" RV Hose W/Male & Female Fittings

Part #	Box Qty	Box Wt
SS4015	1	27

**HI-CAPACITY SYSTEM**

Includes:

- Hi-Capacity Boji      - Activated Carbon Filter Cartridge
- Prefilter Housing w/Clear Canister      - 36" RV Hose W/Male & Female Fittings

Part #	Box Qty	Box Wt
SS6015	1	27

**ACCESSORY ITEMS****PREFILTER W/HOSE FITTINGS**

Used for regenerating the Boji. Includes plastic hose fittings.

Part #	Box Qty	Box Wt
FH10	1	3

**ACTIVATED CARBON FILTER CARTRIDGE**

Replacement filter cartridge for water filter.

Part #	Box Qty	Box Wt
C232	1	1

**WATER METER VALVE**

For monitoring water flow.

Part #	Box Qty	Box Wt
WT101	1	1

**HOSE**

Used to connect Boji Filter to water supply.

Part #	Size	Box Qty	Box Wt
NRVH6	6"	1	1
NRVH36	36"	1	1

**PRESSURE BROCHURE**



This informative brochure with easy to understand instructions, shows how easy it is to install Genova pressure pipe and fittings along with insert fittings and polyethylene pipe.

Part #	Pkg Qty	Box Wt
252217	30	1

**CPVC BROCHURE**



This informative brochure shows how easy it is to install a Genova hot and cold water supply system.

Part #	Pkg Qty	Box Wt
252177	30	1

**UNIVERSAL FITTINGS BROCHURE**

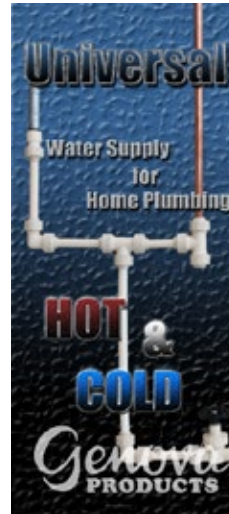

This informative brochure shows how easy it is to install a Genova hot and cold water supply system with your choice of tubing and Universal fittings.

Part #	Pkg Qty	Box Wt
252220	30	1

**PVC-DWV BROCHURE**



This informative brochure shows how easy it is to install Genova's PVC-DWV for the do-it-yourself plumber with basic concepts needed to install a DWV system.

Part #	Pkg Qty	Box Wt
252176	30	1

**ABS-DWV BROCHURE**



This informative brochure provides a handy tool for educating the do-it-yourself plumber with the basic concepts needed to install an ABS system, the easy Genova way.

Part #	Pkg Qty	Box Wt
252264	30	1

**RAINGO® BROCHURE**



This informative brochure shows how easy it is to install a Genova Raingo® gutter and DuraSpout® downspout system.

Part #	Pkg Qty	Box Wt
252174	30	1

**REPLA K® BROCHURE**

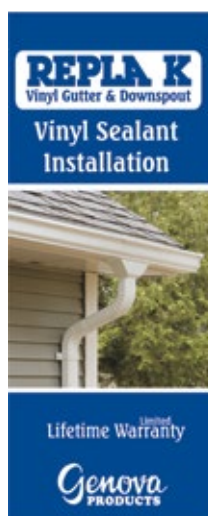

This informative brochure shows how easy it is to install a Genova Repla K® gutter and DuraSpout® downspout system.

Part #	Pkg Qty	Box Wt
252259	30	1

## "DO-IT-YOURSELF PLUMBING" BOOK



This manual is one of the most comprehensive books yet on plumbing installation. Fully illustrated, written for Genova by Richard Day. This guide should be part of every plumbing display.

Part #	Box Qty	Box Wt
253326	10	12

## PRESSURE HEADERBOARD KIT



Part #	Size	Box Qty	Box Wt
266994	16" x 48"	1	5

## INSERT HEADERBOARD KIT



Part #	Size	Box Qty	Box Wt
266999	16" x 48"	1	5

## SEWER & DRAIN HEADERBOARD KIT

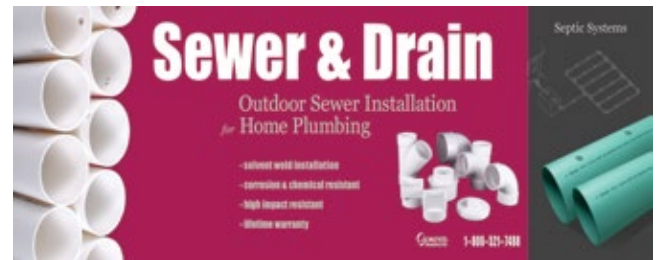

Part #	Size	Box Qty	Box Wt
266998	16" x 48"	1	5

## CPVC HEADERBOARD KIT



Part #	Size	Box Qty	Box Wt
266993	16" x 48"	1	5

\* Each Headboard Kit comes with brochures & a brochure holder that adheres right to the headboard.

## PVC-DWV HEADERBOARD KIT



Part #	Size	Box Qty	Box Wt
266992	16" x 48"	1	5

## ABS HEADERBOARD KIT



Part #	Size	Box Qty	Box Wt
266997	16" x 48"	1	5

## DISPLAY BIN



This durable thermoplastic display bin comes complete with a special pegboard hanger to easily connect to ¼" pegboard displays. This bin can hold a variety of products.

Part #	Size	Box Qty	Box Wt
265325	9" x 5" x 4 ³⁄₈"	10	10

## DIVIDED DISPLAY BIN



This durable thermoplastic divided display bin comes complete with a special pegboard hanger to easily connect to ¼" pegboard displays. This bin can hold a variety of products.

Part #	Size	Box Qty	Box Wt
265335	9" x 5" x 4 ³⁄₈"	10	11

## BIN TAG HOLDER



These flexible, clear, vinyl bin tag holders fit a variety of fixtures.

Part #	Size	Pkg Qty	Box Qty	Box Wt
265362	3 ³⁄₈" x 3 ³⁄₈"	25	3750	42

## RAINGO® HEADERBOARD KIT



Part #	Size	Box Qty	Box Wt
266995	16" x 48"	1	5

## REPLA K® HEADERBOARD KIT



Part #	Size	Box Qty	Box Wt
266996	16" x 48"	1	5

## Genova Products, Inc. Limited Product Warranties

7034 East Court Street  
Box 309  
Davison, MI 48423-  
0309

Form No. 257207  
Printed in USA  
Effective Date: July  
2012

### General - Applies to all Genova Products

All Genova products are warranted only for their expressly recommended applications as further described below. Improper use of Genova products will void all warranties. Genova's liability in all cases is limited to a refund of the factory purchase price or factory replacement of the product proven

to be unserviceable for its intended use. In no case will Genova be responsible for any incidental or consequential damages of any kind, including without limitation any claims for installation labor, property damage or personal injury.

### 100 Series - Tubular, Flashings, Solvent Cements, Specialty Items

Genova warrants all of its 100 Series products to be manufactured in accordance to applicable ASTM standards and to function properly within the limitations posed by standard residential plumbing applications when installed in accordance with good plumbing practice and specific recommendations outlined in our installation manuals. Canned products are warranted to have a shelf life of 12 months from date of delivery or 18 months from the date of manufacture as attested by the date imprinted thereon.

Genova solvent cements and cleaners are warranted to conform with applicable ASTM standards and perform satisfactorily when utilized in accordance to our published instructions.

In no case will claims for installation labor or consequential property damage be honored. THERE ARE NO WARRANTIES, EXPRESSED OR IMPLIED INCLUDING ANY IMPLIED WARRANTY OF MERCHANTABILITY OR FITNESS FOR A PARTICULAR PURPOSE, WHICH EXTEND BEYOND THE ABOVE DESCRIPTION.

### 300 Series - Pressure Pipe and Fittings

Genova pressure pipe and fittings have been designed for outside the house irrigation and residential underground cold water supply applications. Uses for other purposes will void our warranties and no liabilities will be accepted as a result thereof. Genova warrants that its pipe and fittings are produced in conformance to applicable national standards and this fact is attested by independent testing laboratory reports. While reasonable care has been taken in the manufacture, we cannot guarantee the performance of installed jobs, because we have no control over the wide range of installation conditions present.

Note: Class 125 PVC pipe is not warranted by Genova products in any applications. All liabilities incurred by the use of this product shall remain the responsibility of the end user.

In no case will claims for installation labor or consequential property damage be honored. THERE ARE NO WARRANTIES, EXPRESSED OR IMPLIED INCLUDING ANY IMPLIED WARRANTY OF MERCHANTABILITY OR FITNESS FOR A PARTICULAR PURPOSE, WHICH EXTEND BEYOND THE ABOVE DESCRIPTION.

### 400 Series - Sewer Pipe and Fittings

Genova sewer pipe and fittings have been designed for drainage applications servicing inhabited structures. Uses for other purposes will void our warranties and no liabilities will be accepted as a result thereof. Genova warrants that its pipe and fittings are produced in conformance to applicable national standards and this fact is attested to by independent testing laboratory reports. While reasonable care has been taken in the manufacture, we cannot guarantee the performance of installed jobs, because we have no control over the wide range of installation conditions present.

In no case will claims for installation labor or consequential property damage be honored. THERE ARE NO WARRANTIES, EXPRESSED OR IMPLIED INCLUDING ANY IMPLIED WARRANTY OF MERCHANTABILITY OR FITNESS FOR A PARTICULAR PURPOSE, WHICH EXTEND BEYOND THE ABOVE DESCRIPTION.

### 500 Series - CPVC Tubing, CPVC Fittings and Universal Fittings

Genova high-temperature water pipe and fittings have been designed for hot and cold potable water distribution. Uses for other purposes will void our warranties and no liabilities will be accepted as a result thereof. Such systems must be installed in accordance with good plumbing practices, applicable code requirements, Genova's published installation instructions, and must employ adequate protection from water hammer. Genova CPVC water pipe has a long-term rating of 100 PSI at 180°F. Excursions beyond the rated temperature and pressure will void our warranties. Genova manufactures their CPVC pipe and fittings to conform to ASTM Standard D2846. Universal fittings are manufactured to conform to ASSE 1061. Installation or long term storage where CPVC is exposed to direct sunlight or exposure to incompatible thread sealants, oils or other incompatible materials will void our warranty. While reasonable care has been taken in the manufacture, we cannot guarantee the performance of installed jobs, because we have no control over the wide range of installation conditions.

To adapt from traditional piping materials, a special group of patented transition fittings should be used. These fittings are the recommended method of compensating for the different coefficients of expansion which exist between dissimilar materials - the use of other methods or fittings may result in system leaks. Do not enclose transition fittings in walls or other inaccessible places as a matter of good plumbing practice.

In no case will claims for installation labor or consequential property damage be honored. THERE ARE NO WARRANTIES, EXPRESSED OR IMPLIED INCLUDING ANY IMPLIED WARRANTY OF MERCHANTABILITY OR FITNESS FOR A PARTICULAR PURPOSE, WHICH EXTEND BEYOND THE ABOVE DESCRIPTION.

### 600 Series - Schedule 30 In-Wall PVC Drain, Waste and Vent Pipe and Fittings

Genova PVC-DWV pipe and fittings have been designed for drainage applications servicing inhabited structures. Uses for other purposes will void our warranties and no liabilities will be accepted as a result thereof. Genova warrants that its pipe and fittings are produced in conformance to applicable national standards and this fact is attested to by independent testing laboratory reports. Genova manufactures their Schedule 30 In-Wall PVC-DWV pipe and fittings to conform to ASTM Standard D2949. While reasonable care has been taken in

the manufacture, we cannot guarantee the performance of installed jobs, because we have no control over the wide range of installation conditions present.

In no case will claims for installation labor or consequential property damage be honored. THERE ARE NO WARRANTIES, EXPRESSED OR IMPLIED INCLUDING ANY IMPLIED WARRANTY OF MERCHANTABILITY OR FITNESS FOR A PARTICULAR PURPOSE, WHICH EXTEND BEYOND THE ABOVE DESCRIPTION.

### 700 and 800 Series - Schedule 40 PVC & ABS Drain, Wast and Vent Pipe and Fittings

Genova PVC & ABS DWV pipe and fittings have been designed for drainage applications servicing inhabited structures. Uses for other purposes will void our warranties and no liabilities will be accepted as a result thereof. Genova warrants that its pipe and fittings are produced in conformance to applicable national standards and this fact is attested to by independent testing laboratory reports. Genova manufactures their Schedule 40 DWV pipe and fittings to conform to ASTM Standard. While

reasonable care has been taken in the manufacture, we cannot guarantee the performance of installed jobs, because we have no control over the wide range of installation conditions present. In no case will claims for installation labor or consequential property damage be honored. THERE ARE NO WARRANTIES, EXPRESSED OR IMPLIED INCLUDING ANY IMPLIED WARRANTY OF MERCHANTABILITY OR FITNESS FOR A PARTICULAR PURPOSE, WHICH EXTEND BEYOND THE ABOVE DESCRIPTION.

### 900 Series - Check Valves and Polyethylene Pipe

Genova sump pump check valves are designed for use in conjunction with residential sump pumps utilized in single family dwelling applications. Their installation outside the sump pit and uses for all other purposes will void our warranties and no liabilities will be accepted as a result thereof. While reasonable care has been taken in the manufacture, we cannot guarantee the performance of installed jobs, because we have no control over the wide range of installation conditions present.

independent laboratory reports. While reasonable care has been taken in the manufacture, we cannot guarantee the performance of installed jobs, because we have no control over the wide range of installation conditions present.

Note: Non-NSF polyethylene pipe is not warranted by Genova Products in any applications. All liabilities incurred by the use of this product shall remain the responsibility of the end user.

Genova polyethylene pipe has been designed for outside the house irrigation and underground residential cold water supply applications. Uses for other purposes will void our warranties and no liabilities will be accepted as a result thereof. Genova warrants that its polyethylene pipe is produced in accordance to applicable national standards and this fact is attested to by

In no case will claims for installation labor or consequential property damage be honored. THERE ARE NO WARRANTIES, EXPRESSED OR IMPLIED INCLUDING ANY IMPLIED WARRANTY OF MERCHANTABILITY OR FITNESS FOR A PARTICULAR PURPOSE, WHICH EXTEND BEYOND THE ABOVE DESCRIPTION.

(Warranties Continued.....)

## Raingo®, Repla K®, and DuraSpout® Rainwater Systems

Genova warrants all of its Raingo® gutter and downspout, Repla K® gutter and Duraspout® downspout to be manufactured in conformance to its rigid quality assurance standards and to function properly within the limitations posed by standard residential rain gutter applications when installed in accordance to good installation practice and specific recommendations outlined in our installation instructions. In no case will claims for installation labor or consequential property damage be honored. THERE ARE NO WARRANTIES, EXPRESSED OR IMPLIED INCLUDING ANY IMPLIED WARRANTY OF MERCHANTABILITY OR FITNESS FOR A PARTICULAR PURPOSE, WHICH EXTEND BEYOND THE ABOVE DESCRIPTION.

### General

#### IMPORTANT INFORMATION REGARDING USE OF GENOVA PRODUCTS

All Genova products are designed only for their intended use. Any use of our products in applications or for purposes which are contrary to the written recommendations in our catalog, the product packaging or printed on the products themselves, including without limitation any commercial application, any use with compressed air or gases, or any other use or application for which our products were not designed or intended, will void all otherwise applicable warranties, expressed or implied, and will be at the user's sole risk. Improper design, installation, operation or use of our products may cause extensive damage and serious or fatal bodily injury. Genova Products, Inc. is not responsible for any damage, injury or loss which results from or in connection with any unauthorized use or application of our products.

You may also have other rights under state law. In the event of a problem with a warranty service or performance, you may be able to go to small claims court, a State court, or a Federal district court.

Although our warranties do not extend directly to end users of our products, Genova protects the organizations you purchased it from and they can rely on Genova for prompt action.

Should any questions arise concerning our warranties or if you would like to comment on our products our services, please write:

Genova Products  
Customer Service Department  
7034 East Court Street  
Box 309  
Davison, MI 48423-0309