

BASEBALL 2017 LINE UP

GLOVES

BATTING

P. 6 - 23

FIELDING

P. 24 - 37

BATTING TEES

P. 38 - 42

RETURN TRAINERS

P. 43 - 46

BATS

TEEBALL

P. 52 - 53

BACKYARD

P. 54 - 55

PORTABLE SCREENS

P. 47

PITCHING MACHINES

P. 48 - 51

BALLS

BASEBALLS

P. 56

SOFTBALLS

P. 57

TEEBALLS

P. 58 - 59

TRAINING BALLS

P. 60 - 63

BASE SETS

P. 64 - 65

GENERAL ACCESSORIES

P. 66 - 71

EQUIPMENT BAGS

P. 72

CUPS AND SUPPORTERS

P. 73

BASEBALL APPAREL

P. 74 - 75

TEAM LICENSED

P. 76 - 79

PLAYER ROSTER

Franklin Batting Gloves are designed with and supported by the vast majority Major League Baseball® hitters. Among them are established Hall of Famers, as well as today's biggest superstars like Miguel Cabrera, Robinson Cano, Yadier Molina, Jose Abreu and Yoenis Cespedes. All designs and features are created with years of research and feedback from the game's best.

AMERICAN

NATIONAL



Baltimore Orioles
JJ Hardy
Nolan Reimold
Mark Trumbo



Boston Red Sox
Xander Bogaerts
Rafael Devers
Brock Holt
Dustin Pedroia
Hanley Ramirez
Pablo Sandoval
Christian Vazquez



Chicago White Sox
Jose Abreu
Melky Cabrera
Adam Eaton
Avisail Garcia
Tyler Saladino



Cleveland Indians
Marlon Byrd
Rajai Davis
Mike Napoli
Robert Perez
Jose Ramirez
Carlos Santana



Detroit Tigers
Mike Aviles
Miguel Cabrera
Justin Upton



Houston Astros
Jose Altuve
Erik Kratz
Luis Valbuena



KC Royals
Jarrod Dyson
Alex Gordon
Omar Infante
Mike Moustakas
Paulo Orlando
Salvador Perez



LA Angels
Ji-Man Choi
Yunel Escobar
Craig Gentry
Johnny Giavotella
Carlos Perez



Minnesota Twins
Jorge Polanco
Miguel Sano
Daniel Santana



New York Yankees
Brett Gardner
Chase Headley
Gary Sanchez



Oakland A's
Khris Davis
Sam Fuld
Andrew Lambo
Josh Reddick
Marcus Semien



Seattle Mariners
Robinson Cano
Leonys Martin



Tampa Bay Rays
Willy Adames
Logan Forsythe
Nick Franklin
Kevin Kiermaier
Evan Longoria
Logan Morrison
Steve Pearce



Texas Rangers
Hanser Alberto
Joey Gallo
Chris Gimenez
Josh Hamilton
Nomar Mazara
Mike McKenry
Mitch Moreland
Justin Ruggiano



Toronto Blue Jays
Ezequiel Carrera
Edwin Encarnacion
Junior Lake



Arizona Diamondbacks
Nick Ahmed
Socrates Brito
Paul Goldschmidt
Phil Gosselin
Oscar Hernandez
David Peralta
Carlos Rivero
Jean Segura
Rickie Weeks



Atlanta Braves
Eric Aybar
Emilio Bonifacio
Adonis Garcia
Kelly Johnson



Chicago Cubs
David Ross
Ben Zobrist



Cincinnati Reds
Zack Cozart
Ivan DeJesus
Joey Volto



Colorado Rockies
Christian Adames
Daniel Descalso
DJ LeMahieu
Ryan McMahon
Gerardo Parra
Ryan Raburn



LA Dodgers
Austin Barnes
A.J. Ellis
Howie Kendrick
Justin Turner
Chase Utley



Miami Marlins
Chris Johnson
Martin Prado
Donovan Solano



Milwaukee Brewers
Ryan Braun
Keon Broxton
Ramon Flores
Jonathan Lucroy
Martin Maldonado
Colin Walsh



New York Mets
Asdrubal Cabrera
Eric Campbell
Yoenis Cespedes
Juan Lagares



Philadelphia Phillies
Cody Asche
Andres Blanco
J.P. Crawford
Maikel Franco
Freddy Galvis
Cesar Hernandez
Odubel Herrera
Ryan Howard
Darnell Sweeney
Darin Ruf
Carlos Ruiz
Will Venable
Nick Williams



Pittsburgh Pirates
Francisco Cervelli
Cole Figueroa
Starling Marte
Jordy Mercer
Mike Morse
Chris Stewart



San Diego Padres
Jabari Blash
Javy Guerra
Travis Jankowski
Manuel Margot
Yangervis Solarte
Melvin Upton



SF Giants
Christian Arroyo
Trevor Brown
Matt Duffy
Hunter Pence



St. Louis Cardinals
Greg Garcia
Jedd Gyorko
Yadier Molina
Brandon Moss
Jhonny Peralta
Tommy Pham
Ruben Tejada



Washington Nationals
Stephen Drew
Danny Espinosa
Jose Lobaton
Daniel Murphy
Clint Robinson
Jason Werth



#CUSTOMFRANKLIN

SALVADOR PEREZ



2015 SPRING TRAINING™



2015 ALL-STAR



2015 WORLD SERIES® MVP



HARVARD UNIVERSITY BASEBALL

HOW TO PLACE YOUR TEAM ORDER

1: GO TO FRANKLINSPO RTS.COM/CUSTOM

2: PICK YOUR STYLE (THE PRO CLASSIC OR THE CFX® PRO)

3: DESIGN YOUR GLOVES

4: SHARE YOUR GLOVES VIA EMAIL TO:
(TEAMSAL ES@FRANKLINSPO RTS.COM)

5: RECORD PLAYER SIZES

DETAILS: MINIMUM ORDER QTY = 12 PAIRS - LEAD TIME IS 30-60 DAYS



DESIGN YOUR **CUSTOM** BATTING GLOVES AT:
FRANKLINSPO RTS.COM/CUSTOM

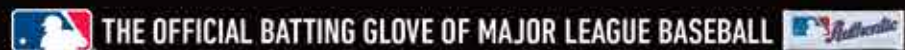

MAJOR LEAGUE BASEBALL TRADEMARKS AND COPYRIGHTS ARE USED WITH PERMISSION OF MAJOR LEAGUE BASEBALL PROPERTIES, INC. VISIT MLB.COM

BATTING GLOVE LINE UP

AUTHENTIC COLLECTION 

AUTHENTIC COLLECTION



PERFORMANCE COLLECTION



RECREATIONAL COLLECTION



MICHAEL CABRERA



GRAY - NAVY
A 20655XX
Y 20605XX

PLAYER SIGNATURE SERIES

WEAR IT LIKE THE PRO'S

WHETHER YOU WANT TO WEAR WHAT YOUR FAVORITE MLB® PROFESSIONAL IS WEARING, OR SIMPLY COLLECT A PIECE OF HISTORY, FRANKLIN'S PLAYER SIGNATURE SERIES™ ALLOWS YOU TO TAKE HOME THE EXACT SAME MODELS YOU SEE ON-FIELD EVERY DAY. WITH ONLY OUR FINEST LEATHERS AND HIGHEST QUALITY MATERIALS, THIS SERIES IS GUARANTEED TO PROVIDE YOU WITH THE GREATEST COMBINATION OF FIT, FEEL, AND PERFORMANCE.

GLOVE SIZES

ADULT	F1 SMALL	F2 MEDIUM	F4 LARGE	F5 X-LARGE	F6 XX-LARGE
YOUTH	F2 MEDIUM	F4 LARGE			

SUPERIOR FEATURES



SEAMLESS PALM DESIGN
All of our authentic gloves are engineered with single-piece palm constructions to help maximize comfort, durability and life-span. Because your gloves should last.



TRI-CURVE® FIT
All Franklin® batting gloves are uniquely engineered to follow the pre-curved anatomy of the human hand. We know we have the perfect fit – we crafted it ourselves.



Pittards® DIGITAL LEATHER
Premium leather with strategically-etched groove patterns reduce palm bunching and greatly improve grip characteristics. Because elite performance requires only the best.



PEARL - TEAL
A 20663XX
Y 20613XX



ROBINSON CANO

POWERSTRAP[™] SERIES

AUTHENTIC COLLECTION 



REVOLUTIONARY WRIST-FASTENING CLOSURE

INTRODUCING THE REVOLUTIONARY NEW POWERSTRAP[™] SERIES! WORKING CLOSELY WITH OUR PROFESSIONAL MLB ATHLETES, WE'VE ENGINEERED THE PERFECT-FIT WRIST-CLOSURE SYSTEM. NO ADJUSTMENTS WILL BE NECESSARY AT THE PLATE, AS YOU ARE GUARANTEED A LOCKED-IN, SNUG FIT AND FEEL. OUR HIGHEST-QUALITY, ONE-PIECE PITTARDS[®] SMOOTH SHEEPSKIN LEATHER PALM PROMISES SOFTNESS AND SUPERIOR GRIP IN ALL CONDITIONS.

Pittards



 SHEEPSKIN LEATHER

PREMIUM SMOOTH SHEEPSKIN LEATHER HANDLED, PROCESSED, AND THOROUGHLY INSPECTED BY OUR TEAM OF EXPERTS TO ENSURE QUALITY, DURABILITY, SOFTNESS, AND SUPPLENESS.



 POWERSTRAP[™] TECH

REVOLUTIONARY WRIST-FASTENING CLOSURE FOR A SNUG FIT THAT REQUIRES NO ADJUSTMENTS AT THE PLATE



 SEAMLESS PALM

ALL FRANKLIN[®] BATTING GLOVES ARE UNIQUELY ENGINEERED TO FOLLOW THE PRE-CURVED ANATOMY OF THE HUMAN HAND. THIS REDUCES BUNCHING AND IMPROVES FIT, FEEL, AND PERFORMANCE.

POWERSTRAP[™]

PATENT PENDING

GLOVE SIZES

ADULT F1 SMALL F2 MEDIUM F4 LARGE F5 X-LARGE F6 XX-LARGE
YOUTH F2 MEDIUM F4 LARGE



BLACK - BLACK

A 20461

Y 20421



PEARL - WHITE

A 20460

Y 20420



PEARL - NAVY - RED

A 20462

Y 20422



CFX PRO SERIES

AUTHENTIC COLLECTION 



THE CHOICE OF THE PROS

FRANKLIN'S CFX® PRO SERIES, OUR MOST POPULAR ON-FIELD MODEL, PROVIDES A SUPERIOR FEEL COMPLEMENTED BY UNIQUE, TECTONIC-FIT INSERT FLEXIBILITY. OUR HIGHEST-QUALITY, ONE-PIECE PITTARDS DIGITAL SHEEPSKIN LEATHER PALM MAINTAINS SOFTNESS AND SUPERIOR GRIP IN ALL CONDITIONS.

Pittards



 **QUAD-FLEX CREASING**

ANTICIPATES FLEXING OF YOUR PALM FOR A PERFECT FIT AROUND THE BAT HANDLE.



 **TECTONIC FIT INSERTS**

ACCOMMODATES FLEX WITHOUT ADDING BULK TO THE BACK OF THE HAND.



 **DIGITAL LEATHER**

STRATEGICALLY-ETCHED GROOVE PATTERNS REDUCE PALM BUNCHING AND GREATLY IMPROVE GRIP CHARACTERISTICS.

CFX PRO®

GLOVE SIZES

ADULT **F1 SMALL F2 MEDIUM F4 LARGE F5 X-LARGE F6 XX-LARGE**
 YOUTH **F2 MEDIUM F4 LARGE**



PEARL - WHITE
A 20560XX
Y 20510XX



BLACK - BLACK
A 20551XX
Y 20501XX



PEARL - ROYAL
A 20552XX
Y 20502XX



PEARL - NAVY
A 20567XX
Y 20517XX



NAVY - CAROLINA BLUE
A 20557XX
Y 20507XX



RED - OPTIC YELLOW
A 20562XX
Y 20512XX



GRAY - RED
A 20555XX
Y 20505XX

CFX[®] PRO REVOLT SERIES



AUTHENTIC COLLECTION



AUTHENTIC COLLECTION

SALVADOR PÉREZ



LIGHT IT UP!

3-TIME AL[™] ALL-STAR (2013-2015) 2015 WORLD SERIES[™] MVP

JUSTIN UPTON



2-TIME SILVER SLUGGER AWARD WINNER 3-TIME NL[™] ALL-STAR



CFX[®] PRO DIGI SERIES



OPTIC YELLOW - RED

A 20685XX

Y 20665XX



OPTIC YELLOW - BLACK

A 20686XX

Y 20666XX



OPTIC YELLOW - BLUE

A 20687XX

Y 20667XX



PEARL - NAVY

A 20635XX

Y 20615XX



BLACK - GREEN

A 20636XX

Y 20616XX



PEARL - BLACK

A 20637XX

Y 20617XX

REVOLUTIONARY OPTIC LEATHER

REVOLUTIONARY DIGI CAMO TECHNOLOGY

NEO CLASSIC II

AUTHENTIC COLLECTION 

AUTHENTIC COLLECTION 



THE CLASSIC. NOW.

FRANKLIN'S NEO CLASSIC® II DRAWS ITS ROOTS FROM OUR VERY FIRST BATTING GLOVE EVER CREATED, AND REMAINS A POPULAR STYLE AMONG OUR ON-FIELD PLAYERS. HIGHLIGHTED BY OUR HIGHEST-QUALITY, ONE-PIECE PITTARDS® DIGITAL SHEEPSKIN LEATHER PALM AND AN ULTRA-COMFORTABLE PRO-GRADE SPANDEX HAND BACK, YOU CAN BE CONFIDENT THAT YOUR SWING WILL BE THE ONLY THING YOU NEED TO FOCUS ON WHEN AT THE PLATE. *Pittards*



THE CLASSIC IS BACK

THE GLOVE THAT STARTED IT ALL, FRANKLIN'S PRO CLASSIC, REPRESENTS THE HERITAGE OF OUR BATTING GLOVE LINE. HALL OF FAMER MIKE SCHMIDT HELPED TO DESIGN THE GLOVE FOR LASTING SUCCESS AT THE MAJOR LEAGUE LEVEL. PROS RANGING FROM CAL RIPKEN & KIRBY PUCKETT TO YADIER MOLINA & CHASE UTLEY HAVE PROUDLY EMBRACED THE STYLE. WITH A ONE-PIECE, ULTRA-COMFORTABLE PRO-GRADE SPANDEX HAND BACK, AND A SEAMLESS PITTARDS® DIGITAL SHEEPSKIN LEATHER PALM, YOU'RE GOING TO BE GLAD THAT THE LEGEND HAS RETURNED. *Pittards*

PRO CLASSIC

GLOVE SIZES
 ADULT F1 SMALL F2 MEDIUM F4 LARGE F5 X-LARGE F6 XX-LARGE
 YOUTH F2 MEDIUM F4 LARGE

GLOVE SIZES
 ADULT F1 SMALL F2 MEDIUM F4 LARGE F5 X-LARGE F6 XX-LARGE
 YOUTH F2 MEDIUM F4 LARGE



A 10910XX
Y 10900XX

PEARL - WHITE



A 10917XX
Y 20917XX

RED - RED



A 20960XX
Y 20930XX

BLACK - OPTIC YELLOW



A 20970XX
Y 20940XX

PEARL - RED



A 20971XX
Y 20941XX

PEARL - ROYAL



A 20973XX
Y 20943XX

BLACK - BLACK

ALL-WEATHER PRO

AUTHENTIC COLLECTION 



CHOOSE YOUR SEASON

FRANKLIN'S ALL-WEATHER PRO UTILIZES THE LATEST THERMOREGULATION TECHNOLOGY IN ORDER TO KEEP YOUR HANDS WARM IN COOL WEATHER WHILE STILL ALLOWING FOR OPTIMUM BREATHABILITY IN THE HEAT. OUR HIGHEST-QUALITY PITTARDS® DIGITAL SHEEPSKIN LEATHER MAINTAINS SOFTNESS AND SUPERIOR GRIP IN ALL CONDITIONS.

Franklin

GLOVE SIZES	ADULT	F1 SMALL	F2 MEDIUM	F4 LARGE	F5 X-LARGE	F6 XX-LARGE
	YOUTH	F2 MEDIUM		F4 LARGE		



A 20754XX
Y 20704XX

BLACK - WHITE DIGI



A 20751XX
Y 20701XX

BLACK - BLACK

CHOOSE YOUR SEASON

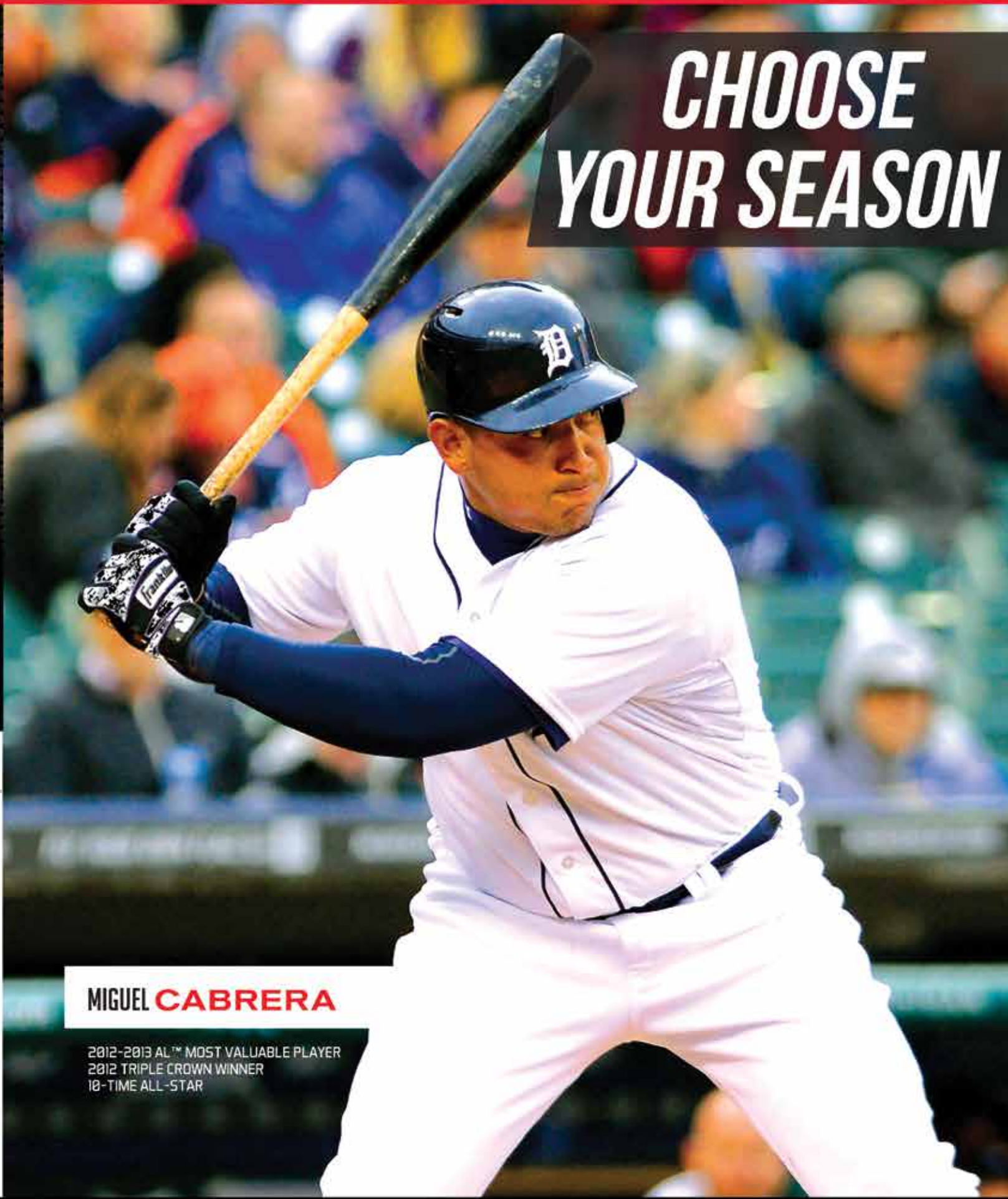

MIGUEL CABRERA

2012-2013 AL™ MOST VALUABLE PLAYER
2012 TRIPLE CROWN WINNER
10-TIME ALL-STAR

FREEFLEX SERIES

PERFORMANCE COLLECTION

PERFORMANCE COLLECTION



EXPERIENCE THE FREEDOM

FRANKLIN'S FREEFLEX SERIES HAS BEEN ENGINEERED TO PROVIDE PEAK PERFORMANCE IN COMBINATION WITH OUR LIGHTEST-WEIGHT, LEAST RESTRICTIVE HAND BACK POSSIBLE. THIS SERIES FEATURES OUR EXTRA-BREATHABLE COOLMAX® MESH FOR SUPERIOR VENTILATION AND FLEXIBILITY, AND IS HIGHLIGHTED BY AN EXTREMELY DURABLE, GENUINE LEATHER PALM. GO AHEAD – EXPERIENCE THE FREEDOM.



GENUINE LEATHER PALM

FRANKLIN'S REVOLUTIONARY NEW FULL-LEATHER X-VENT PRO SERIES FUSES ULTRA-LIGHTWEIGHT TECHNOLOGY WITH SUPERIOR FLEXIBILITY AND MAXIMUM BREATHABILITY FOR THE ULTIMATE COMBINATION OF PERFORMANCE. TAKE YOUR SWINGS. WE'LL DO THE REST.

X-VENT PRO

GLOVE SIZES

ADULT F1 SMALL F2 MEDIUM F4 LARGE F5 X-LARGE

YOUTH F1 SMALL F2 MEDIUM F4 LARGE

ADULT F1 SMALL F2 MEDIUM F4 LARGE F5 X-LARGE

YOUTH F1 SMALL F2 MEDIUM F4 LARGE

GLOVE SIZES



A 20860XX
Y 20810XX

BLACK - BLACK



A 20861XX
Y 20811XX

BLACK - ROYAL



A 20862XX
Y 20812XX

WHITE - WHITE



A 21353XX
Y 21303XX

BLACK - GRAY



A 21355XX
Y 21305XX

BLACK - NEON ORANGE



A 21356XX
Y 21306XX

WHITE - NAVY

SHOK-SORB® NEO

PERFORMANCE COLLECTION

RECREATIONAL COLLECTION



ELITE STING-REDUCTION TECHNOLOGY

THE IDEAL "ALL-AROUND" GLOVE, FRANKLIN'S SHOK-SORB® NEO PROVIDES SUPERIOR STING-REDUCTION TECHNOLOGY IN THE PALM WHILE MAINTAINING SUPERIOR GRIP IN ALL WEATHER CONDITIONS. THIS NEW DESIGN HAS AN EXTREMELY COMFORTABLE FIT ALONG WITH STRATEGICALLY-PLACED FLEX POINTS FOR A NON-RESTRICTIVE PERFORMANCE.



JOIN THE DIGI REVOLUTION

FRANKLIN'S DIGITEK SERIES IS A SUPERIORLY FLEXIBLE, MULTI-FUNCTIONAL GLOVE WITH AN ATHLETIC FIT, FEEL, AND LOOK. WITH AN EXTENDED, DURABLE LEATHER HEEL PATCH AND A TOUCH OF DIGITAL-CAMO FLAIR, YOU CAN BE SURE TO COUNT ON THIS GLOVE FOR GAME-TIME PERFORMANCE.

DIGITEK SERIES

GLOVE SIZES

ADULT F1 SMALL F2 MEDIUM F4 LARGE F5 X-LARGE
YOUTH F1 SMALL F2 MEDIUM F4 LARGE

ADULT F1 SMALL F2 MEDIUM F4 LARGE F5 X-LARGE
YOUTH F1 SMALL F2 MEDIUM F4 LARGE

GLOVE SIZES



A 20950XX
Y 20920XX

WHITE - BLACK



A 20951XX
Y 20921XX

BLACK - RED



A 20958XX
Y 20928XX

GRAY - NAVY



A 21058XX
Y 21008XX

GRAY - BLACK - RED



A 21059XX
Y 21009XX

GRAY - BLACK - ROYAL



A 21060XX
Y 21010XX

WHITE - BLACK - BLACK

2ND-SKINZ®



ACTIVATE YOUR SWING

THE 2ND-SKINZ® SERIES PROVIDES A GREAT FEEL AND GRIP FOR YOUTH BALLPLAYERS WITH OUR SIGNATURE, DIGITALLY-ETCHED SYNTHETIC PALM. OUR LEATHER HEEL PATCH ENSURES DURABILITY, AND A CENTRALIZED LYCRA-FLEX HAND BACK ALLOWS THIS GLOVE TO ADAPT TO ALL PLAYERS' NEEDS.



EMBRACE YOUR FLEX

OUR YOUTH FLEX SERIES FEATURES A SLEEK, LYCRA-FLEX AND SYNTHETIC HAND BACK FOR MAXIMUM FLEXIBILITY. THE DIGITALLY-ETCHED, ONE-PIECE SYNTHETIC PALM CATER TO THE NEED FOR A LIGHT-WEIGHT, DURABLE, AND ENHANCED GRIP TO MAKE FOR A GREAT YOUTH GLOVE FOR ALL YOUNG ATHLETES.

YOUTH FLEX

GLOVE SIZES

ADULT **F1 SMALL F2 MEDIUM F4 LARGE F5 X-LARGE**
 YOUTH **F00 XX-SMALL F0 X-SMALL F1 SMALL F2 MEDIUM F4 LARGE**

GLOVE SIZES

YOUTH **F00 XX-SMALL F0 X-SMALL F1 SMALL F2 MEDIUM F4 LARGE**



A 21150XX
Y 21100XX

WHITE - BLACK



A 21151XX
Y 21101XX

WHITE - RED



A 21160XX
Y 21110XX

GRAY - NAVY



Y 21200XX

BLACK - WHITE



Y 21203XX

WHITE - PINK

FIELDING GLOVE LINE UP

BASEBALL COLLECTION



PRO FLEX

RTP PRO

YOUTH COLLECTION



ACD FLEXLINE

NOVAWEB

FIELDMASTER

SOFTBALL COLLECTION



FASTPITCH PRO

TEEBALL COLLECTION



DIGITEK

MESHTEK

NEO GRIP

SUPERIOR FEATURES



RTP® READY TO PLAY

All franklin® gloves are designed with our ready-to-play technology, ensuring they are flexible, functional, and durable. Because gloves should go straight from the field without any break-in required.



CFS® CONTOUR FIT SYSTEM

Our obsession with elite fit and feel lead us to engineer and contour all wrist closures such that they allowed maximum flexibility and performance. We've studied the human hand and crafted our gloves as an extension of such.



HAND-CRAFTED

All of our fielding gloves are hand-crafted by skilled professionals who pass the gloves onto "fit experts." every inch of the glove is inspected and re-worked until we are confident the fit, feel, and performance are elite.



PREMIUM COWHIDE LEATHER PALM

DURABLE PU/PVC HYBRID DESIGNED SHELL

ADJUSTABLE WRIST CLOSURE PROVIDES FOR A CUSTOM FIT

PREMIUM COWHIDE/PU HYBRID DESIGN

THE PRO FLEX® HYBRID SERIES FIELDING GLOVES COMBINE A PREMIUM COWHIDE PALM WITH A PU-LAMINATED PVC HYBRID SHELL. ALL MATERIALS ARE SPECIALLY TREATED TO GO FROM THE STORE SHELF TO THE PLAYING FIELD WITH NO BREAK-IN REQUIRED. AN ADJUSTABLE WRIST STRAP PROVIDES A CUSTOM AND VERSATILE FIT.

PRO FLEX
HYBRID SERIES

13.5"

4115 PACK 3



13.0"

4114 PACK 3



12.5"

4113 PACK 3
(LHT) 4113L OPEN STOCK



12.0"

4112 PACK 3



11.5"

22500 PACK 3



RTP PRO SERIES



PREMIUM PIGSKIN LEATHER PALM
 PREMIUM PIGSKIN LEATHER SHELL
 ADJUSTABLE WRIST CLOSURE PROVIDES FOR A CUSTOM FIT

FLEXIBLE PREMIUM PIGSKIN LEATHER

THE RTP PRO SERIES OFFERS FULL LEATHER FEEL AND FIT IN A PREMIUM PIGSKIN LEATHER CONSTRUCTION. THESE GLOVES ARE EXTREMELY SOFT AND FLEXIBLE WITH THE SUBSTANCE AND INTEGRITY OF FULL LEATHER. THIS IS A GREAT RANGE OF GLOVES THAT TAKES DESIGN DIRECTION FROM PROFESSIONAL MODELS TO A LIGHTER, MORE FLEXIBLE OFFERING.



SOFT PU-LAMINATED CONSTRUCTED PALM
 LIGHTWEIGHT, TECHNICAL MESH DESIGNED SHELL
 ADJUSTABLE WRIST CLOSURE PROVIDES FOR A CUSTOM FIT

SOFT PU/TECHNICAL MESH CONSTRUCTION

THE FASTPITCH PRO SERIES OFFERS A QUALITY LINE OF SOFTBALL GLOVES UTILIZING A LIGHTWEIGHT, TECHNICAL-MESH SHELL AND A SOFT, PU LAMINATED PALM FOR THE ULTIMATE IN COMFORT AND PERFORMANCE. AN ADJUSTABLE WRIST STRAP PROVIDES A CUSTOM AND VERSATILE FIT.

FASTPITCH PRO SERIES

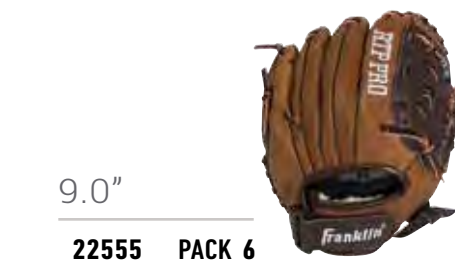

ACD FLEXLINE SERIES

YOUTH COLLECTION

YOUTH COLLECTION



- PREMIUM PIGSKIN LEATHER PALM
- LIGHTWEIGHT, DURABLE MESH SHELL
- FLEXLINE TECHNOLOGY INCREASES FLEXIBILITY IN PALM
- DEEPWEB TECHNOLOGY PROVIDES SUPERIOR CATCHING CAPABILITY

PREMIUM PIGSKIN/MESH HYBRID

THE RE-DESIGNED ACD FLEXLINE SERIES COMBINES OUR SUPPLE, PREMIUM PIGSKIN LEATHER WITH OUR LIGHTWEIGHT, TECHNICAL MESH SHELL. OUR DEEPWEB TECHNOLOGY LENDS A HAND WITH SUPERIOR CATCHING ABILITY, WHILE OUR FLEXLINE PROVIDES ADDED FLEXIBILITY WHERE YOUR HAND NEEDS IT MOST. THIS GLOVE IS SURE TO ENHANCE YOUR PERFORMANCE ON THE FIELD AND GIVE YOU THE CONFIDENCE TO SUCCEED.



- SYNTHETIC LEATHER PALM
- SYNTHETIC LEATHER SHELL
- CONTOUR FIT SYSTEM™ PROVIDES CUSTOMIZABLE FINGER ADJUSTMENTS

ULTRA-DURABLE SYNTHETIC CONSTRUCTION

THE FIELD MASTER® SERIES OFFERS AN EXTENSIVE LINE OF QUALITY SYNTHETIC-LEATHER GLOVES FOR THE RECREATIONAL PLAYER. UTILIZING A THICKER, MORE DURABLE SYNTHETIC, WE'VE BEEN ABLE TO MIMIC THE SUPPLENESS AND DURABILITY OF TRUE LEATHER TO PROVIDE PREMIUM PERFORMANCE CHARACTERISTICS. THE LINE REPRESENTS THE MOST POPULAR SIZES, SHAPES AND WEB DESIGNS WITH THE FEEL OF A BROKEN-IN, READY-TO-PLAY GLOVE.

FIELD MASTER SERIES



11.0"
22460 PACK 6
 (LHT) **22460L** OPEN STOCK

10.0"
22461 PACK 6

9.0"
22462 PACK 6

14.0"
22600 PACK 6
 (LHT) **22600L** OPEN STOCK

13.0"
22601 PACK 6
 (LHT) **22601L** OPEN STOCK

12.5"
22602 PACK 6
 (LHT) **22602L** OPEN STOCK

12.0"
22603 PACK 6
 (LHT) **22603L** OPEN STOCK

11.0"
22604 PACK 6
 (LHT) **22604L** OPEN STOCK

10.5"
22606 PACK 6
 (LHT) **22606L** OPEN STOCK

10.0"
22607 PACK 6
 (LHT) **22607L** OPEN STOCK

NOVAWEB™ CUSTOM SERIES

YOUTH COLLECTION



CUSTOMIZE YOUR WEB!

THE NOVAWEB™ CUSTOM SERIES IS THE FIRST AND ONLY GLOVE THAT ALLOWS ONE TO CUSTOMIZE THEIR VERY OWN WEB! TO DO SO, REMOVE THE CURRENT LACES AND CHOOSE THE TWO COLORS YOU'D LIKE TO USE. TIE THESE TWO LACES TOGETHER IN THE MIDDLE, AND THEN RE-LACE THE WEB AS YOU WOULD LACE A SNEAKER! LET YOUR CUSTOMIZED NOVAWEB SHINE!

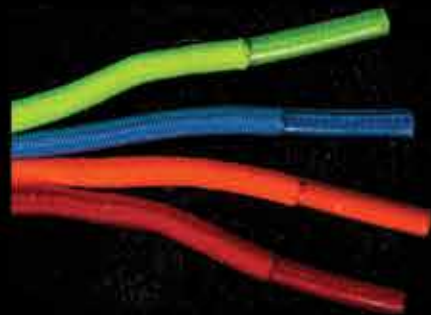

CHOOSE TWO COLORS

EACH GLOVE COMES WITH FOUR COLOR OPTIONS TO CHOOSE FROM TO MAKE IT YOUR OWN



INSERT ENDS INTO CLIP

PULL LACES THROUGH DESIGNATED BUNGEE AREA TO CLIP TOGETHER AND KEEP SECURE



LACE THE WEB!

EASY TO FOLLOW BUNGEE MAKE LACING YOUR GLOVE AS SIMPLE AS LACING A SNEAKER

NOVAWEB™ CUSTOM SERIES



11.0"

22410 PACK 6

(LHT) 22410L OPEN STOCK



10.0"

22411 PACK 6



9.0"

22412 PACK 6



**INFINITE®
WEB
SHOK-SORB®
SERIES**

TEEBALL COLLECTION



RTP READY-TO-PLAY CONSTRUCTION

SHOK-SORB'S PALM STING-REDUCTION TECHNOLOGY

WEB EXPANSION TECHNOLOGY ADJUSTS TO PLAYERS NEEDS

HYBRID STING-REDUCTION & WEB-EXPANSION TECHNOLOGY

FRANKLIN® TEE BALL INFINITE WEB®/SHOK-SORB® COMBO SERIES GLOVES OFFER THE LATEST TECHNOLOGY IN WEB EXPANSION AND PALM STING REDUCTION. THIS PERFECT COMBINATION IS IDEAL FOR YOUNG TEE BALL PLAYERS LOOKING TO BUILD CONFIDENCE IN THEIR GAME WITH A FUNCTIONAL, LIGHTWEIGHT GLOVE.



LIGHTWEIGHT PERFORMANCE DESIGN

RTP READY-TO-PLAY CONSTRUCTION

TEEBALL-FIT WRIST CLOSURE DESIGN

RTP READY-TO-PLAY TECHNOLOGY

FRANKLIN® TEE BALL PERFORMANCE SERIES GLOVES OFFER THE LIGHTEST AND MOST COMFORTABLE GLOVES FOR ANY BEGINNER TRYING TO GET INTO THE GAME. USING OUR RTP READY-TO-PLAY CONSTRUCTION, THESE GLOVES GO STRAIGHT FROM THE SHELF TO THE PLAYING FIELD WITH NO BREAK-IN REQUIRED.

**RTP PERFORMANCE
SERIES**



10.5"

22750 PACK 6



10.5"

22754 PACK 6



10.5"

22756 PACK 6



9.5"

4809TB PACK 6
(W/BALL) 4809TBS PACK 6
(LHT W/BALL) 4809TBSL OPEN STOCK



9.5"

22702 PACK 6
(W/BALL) 22703 PACK 6
(LHT W/BALL) 22703L OPEN STOCK



10.0"

22840 PACK 6



9.5"

(W/BALL) 22849 PACK 6
(LHT) 22839 PACK 6
(LHT W/BALL) 22849L OPEN STOCK
(LHT W/BALL) 22839L OPEN STOCK



10.0"

22841 PACK 6



9.5"

(W/BALL) 22856 PACK 6
(LHT) 22846 PACK 6
(LHT W/BALL) 22856L OPEN STOCK
(LHT W/BALL) 22846L OPEN STOCK

MESHTEK SERIES

NEO-GRIP® SERIES



LIGHTWEIGHT TECHNICAL MESH SHELL
 RTP READY-TO-PLAY CONSTRUCTION
 TEEBALL-FIT WRIST CLOSURE DESIGN

LIGHTWEIGHT MESH SHELL
 RTP READY-TO-PLAY CONSTRUCTION
 REVOLUTIONARY PALM GRIP MINIMIZES BOUNCEOUTS

LIGHTWEIGHT MESH TECHNOLOGY

FRANKLIN® TEE BALL MESHTEK SERIES GLOVES OFFER THE LIGHTEST AND MOST COMFORTABLE GLOVES FOR ANY FIRST-TIME PLAYERS. UTILIZING OUR INNOVATIVE AND LIGHTWEIGHT TECHNICAL-MESH SHELL CONSTRUCTION, THESE GLOVES ARE SOFT AND EASIER FOR THE YOUNGER PLAYERS TO SQUEEZE CLOSED.

REVOLUTIONARY GRIP TECHNOLOGY MINIMIZES BOUNCEOUTS

FRANKLIN® NEO-GRIP® SERIES GLOVES OFFER REVOLUTIONARY NEO-GRIP® PALM TECHNOLOGY TO MAXIMIZE CATCHING ABILITY FOR THE YOUNGEST TEE BALL PLAYERS. USING OUR RTP CONSTRUCTION, THESE GLOVES GO STRAIGHT FROM THE SHELF TO THE PLAYING FIELD WITH NO BREAK-IN REQUIRED.



9.5"

22800 PACK 6
 (W/BALL) 22810 PACK 6
 (LHT W/BALL) 22810L OPEN STOCK



9.5"

22802 PACK 6
 (W/BALL) 22812 PACK 6
 (LHT W/BALL) 22812L OPEN STOCK



9.5"

22804 PACK 6
 (W/BALL) 22814 PACK 6
 (LHT W/BALL) 22814L OPEN STOCK



9.5"

(W/BALL) 22850 PACK 6
 (LHT) 22850L OPEN STOCK



9.5"

(W/BALL) 22851 PACK 6
 (LHT) 22851L OPEN STOCK



9.5"

(W/BALL) 22852 PACK 6
 (LHT) 22852L OPEN STOCK

AIR TECH® SERIES



SOFT LIGHTWEIGHT PVC CONSTRUCTION

ADJUSTABLE SELF-STICK WRIST CLOSURE

LIGHTWEIGHT AIR TECH® TECHNOLOGY

FRANKLIN® AIR TECH® SERIES GLOVES OFFER A SOFT AND DURABLE GLOVE FOR ANY FIRST-TIME PLAYER. THESE GLOVES ARE EASIER FOR THE YOUNGER PLAYERS TO SQUEEZE CLOSED AND INCLUDES A LIGHTER WEIGHT BALL FOR LEARNING TO CATCH



NEW! GLOW SERIES

PLAYIN THE LIGHT AND AT NIGHT!
GLOWS FOR OVER AN HOUR!



GO WILD

NEW AIR TECH® WILD SERIES GLOVE AND BALL SET LETS YOU SHOW YOUR TRUE COLORS

9IN SOFT FOAM BASEBALL GLOVE AND STITCHED BALL

ITEM 6844S1F1
PACK 4



GLOMAX® 9IN GITD GLOVE AND FOAM BALL

- PLAY IN THE LIGHT AND AT NIGHT
- SUPER SOFT GITD FOAM BALL
- GLOWS FOR 1 HOUR +

ITEM 68016
PACK 4



8.5 IN SOFT FOAM WILD SERIES GLOVE AND FOAM BALL

ITEM 68015
PACK 4



8.5 IN SOFT FOAM SPORT SERIES GLOVE AND FOAM BALL

ITEM 68010A
PACK 4



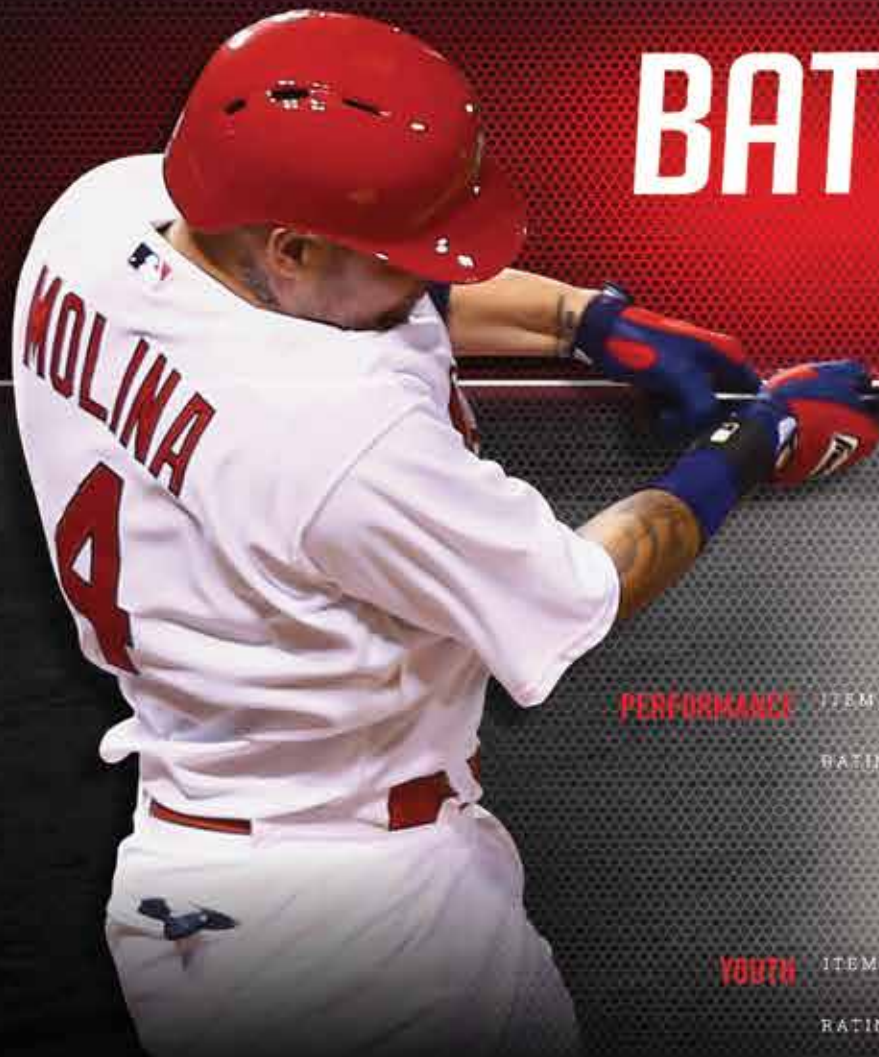

BATTING TEE

LINE UP

PERFORMANCE	ITEM	24847	14874	1957	24855	24845	24848
RATING		***	**	**	**	***	**

YOUTH	ITEM	14062	64060	1559S1	24857	64037
RATING		**	*	*	*	*

SUPERIOR FEATURES



RUBBER-TEK™ BASE

Lab tested 2X stronger than traditional rubber

INNOVATION

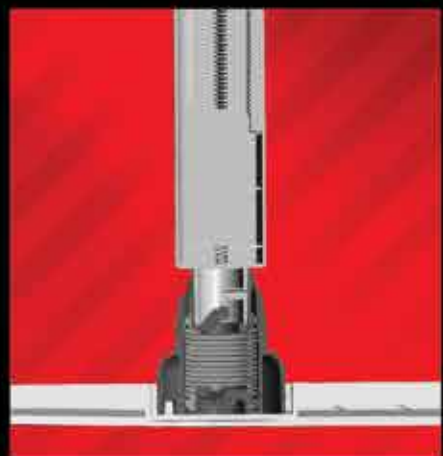

PATENTED DESIGN

Anti-tip system helps keep the tee from tipping over

TECHNOLOGY



MULTI-POSITION

360 Degree full range locking post for infinite ball positions

PERFORMANCE

PRO-PORTA REPLACEMENT TEE TOPPER

NEW & IMPROVED!

NOW TIGHTER FOR MORE VISIBILITY ON THE BALL AND LESS RESISTANCE

ITEM 24833
PACK 6



PRO-PORTA II TEE

- DURABLE POLISHED ALUMINUM POST
- NEW TWIST & LOCK DESIGN FOR EASY ADJUST HEIGHT
- ADJUSTS FROM 27" TO 37" HIGH
- RUBBER-TEK® INJECTION PLATE WITH METAL MOUNTING PLATE FOR SECURE INSTALLATION
- HAND-ROLLED RUBBER BALL HOLDER - NEW & IMPROVED! NOW TIGHTER FOR MORE VISIBILITY ON THE BALL AND LESS RESISTANCE
- WEIGHTED BASE FOR ADDED STABILITY
- ALL WEATHER FINISH
- GREAT FOR ALL AGES
- SLIDE 10LB WEIGHT OVER THE TEE FOR ADDED STABILITY- WEIGHT SOLD SEPARATELY
- PATENT PENDING

ITEM 24847
PACK 4



NEW & IMPROVED! LOCKING SYSTEM AND WEIGHTED BASE

THE ULTIMATE PROFESSIONAL BATTING TEE, DESIGNED AND DEVELOPED FOR THE ELITE PLAYER. THIS TEE IS CONSTRUCTED WITH THE FINEST MATERIALS AND TESTED AT THE HIGHEST LEVEL. THE HAND ROLLED CONICAL SHAPED BALL HOLDER IS DESIGNED FOR MINIMUM RESISTANCE AND MAXIMUM DURABILITY. ALL PLAYERS WILL ENJOY THE PERFORMANCE OF THIS TEE.

2 in 1 POWER SPRING SWING POP UP BATTING TEE

- BATTING TEE ADJUSTS FROM 22" TO 28" HIGH
- EASY ASSEMBLY AND BREAKDOWN FOR STORAGE
- U.S. PATENT NO. 7,704,168

ITEM 14574
PACK 4

SIMPLE OPERATION:

1. PRESS BALL DOWN ON POST
2. GET INTO BATTING STANCE
3. WAIT FOR THE BALL RELEASE AND SWING.

THE BALL POPS INTO THE HITTING ZONE EVERY TIME!

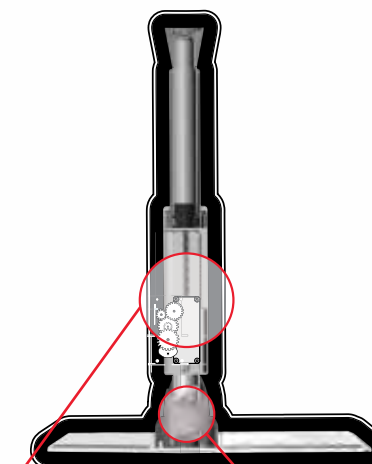

DELAYED TIME RELEASE-
ALLOWS BATTER TIME TO GET INTO
PROPER STANCE

ANTI-TIP JOINT HELPS REDUCE
THE TEE FROM TIPPING OVER



1-POSITION RUBBER-TEK™ BATTING TEE

- RUBBERTEK CONSTRUCTION LAB TESTED TO BE 2X STRONGER THAN TRADITIONAL RUBBER TEES
- QUICK AND EASY HEIGHT ADJUSTMENT FROM 20 (50.8CM) TO 36IN (91.4CM) BUILT IN CARRY HANDLE AND STORAGE STRAPS
- EASY ASSEMBLY AND BREAKDOWN FOR STORAGE
- QUICK AND EASY HEIGHT ADJUSTMENT FROM 20IN 50.8CM) TO 36IN (91.4CM)
- IMPROVES SWING MECHANICS AND HAND-EYE COORDINATION
- BUILT IN CARRY HANDLE & STORAGE STRAPS FOR EASY PORTABILITY

ITEM 24856
PACK 3



THIS IS A TRADITIONAL RUBBER BATTING TEE GREAT FOR PRACTICE OR YOUTH T-BALL GAMES.

*LAB TESTED TO BE
2X
STRONGER THAN
TRADITIONAL RUBBER TEES



STORAGE STRAPS FOR EASY PORTABILITY



ROTATOR TEE

- 360° FULL RANGE LOCKING POST FOR INFINITE BALL POSITIONS
- DURABLE RUBBER-TEK™ HOME PLATE WITH STEEL SUPPORT EXTENDERS FOR ADDED STABILITY
- ADJUSTS 22" TO 36"
- VERTICAL HEIGHT INDICATOR WINDOW

ITEM 24848
PACK 3



DEVELOPED TO ALLOW BATTERS TO PRACTICE HITTING OUTSIDE, MIDDLE, INSIDE, HIGH AND LOW PITCHES. THE INNOVATIVE TEE SWIVELS AND LOCKS INTO POSITION FOR FULL PLATE COVERAGE.

SPRING SWING BATTING TEE

- SPECIALIZED FLEXIBLE PVC BALL HOLDER FOR BETTER BALL CONTACT
- PERFECT TEE FOR BEGINNERS
- ADJUSTS FROM 20" TO 32" IN HEIGHT
- EASY SNAP AND TWIST ASSEMBLY
- U.S. PATENT NO. 7,704,168

ITEM 14062
PACK 6



THE INNOVATIVE AND PATENTED SPRING MECHANISM PROVIDES A NO-HASSLE PRACTICE. THE POST RETURNS TO HITTING POSITION EVERY TIME ALLOWING FOR CONTINUOUS PRACTICE WITHOUT INTERRUPTION. A GREAT TEE TO IMPROVE THEIR CONFIDENCE, SWING MECHANICS, AND BODY POSITIONING.

TRAINING BATTING TEES

3-POSITION RUBBER BATTING TEE

- HIGH-QUALITY, ALL-RUBBER CONSTRUCTION
- TRAIN IN 3 DIFFERENT HITTING POSITIONS
- RUBBER POST ADJUSTS FROM 20" TO 36" HIGH
- BUILT-IN CARRY HANDLE AND STORAGE STRAPS; BATTING TIPS INCLUDED
- EASY ASSEMBLY AND BREAKDOWN FOR STORAGE
- U.S. PATENT NO. D513,294

ITEM 1957
PACK 3



THE ADJUSTABLE 3-POSITION TEE IS THE PERFECT BASEBALL TEE TO HELP YOU LEARN HOW TO POSITION YOURSELF CORRECTLY FOR OUTSIDE, MIDDLE, AND INSIDE PITCHES. BUILT-IN HANDLE & STRAPS MAKES IT EASY TO CARRY AND STORE.

XT-PRO BATTING TEE

- STURDY STEEL CONSTRUCTED "X" BASE DESIGN
- QUICK & EASY HEIGHT ADJUSTMENT ADJUSTS FROM 20" TO 36" HIGH
- EASILY TWISTS APART FOR TRAVEL OR STORAGE
- INCLUDES TRAVEL BAG

ITEM 24845
PACK 4



THIS IS A HEAVY DUTY, PORTABLE TEE. THE XT-PRO EASILY TWISTS APART AND FITS INTO ANY BAT BAG. THIS IS THE PERFECT TAKE ME ANYWHERE TEE.

TEEBALL STARTER SET

- MULTI-POSITION PLASTIC BATTING TEE W/ BALL RETURN
- 36" X 36" RETURN TRAINER WITH 3/4" STEEL TUBING
- 21-PLY ALL-WEATHER PE NET WITH TARGET RIBBON
- BUNGEE CORD ATTACHMENT SYSTEM
- SOME ASSEMBLY REQUIRED
- 4 PIECE EVA BASE SET

ITEM 1993S1
PACK 2



A COMPLETE STARTER SET FOR HITTING, THROWING, AND FIELDING PRACTICE, AND EVEN BASES FOR A GAME

YOUTH BATTING TEE

- STARTER TEE WITH TELESCOPING POST ADJUSTS FROM 23" TO 33"
- HIGH-IMPACT POST WITH PLASTIC HOME PLATE
- ANTI-TIP FLEXIBLE PVC POST CONNECTOR
- BUILT-IN CARRY HANDLE AND STORAGE STRAP

ITEM 1559S1
PACK 6



BUILT IN
CARRY HANDLE
AND STORAGE
STRAPS



DESIGNED FOR THE BEGINNER, THIS TEE IS HAS A FLEXIBLE POST WHICH IS DESIGNED TO ABSORB THE MOMENTUM OF THE SWING AND REDUCE THE TEE FROM FALLING OVER.

**XT YOUTH
BATTING TEE** 

ITEM 24857
PACK 4

**XT YOUTH
BATTING TEE FOAM SET** 

ITEM 64060
PACK 4

**STURDY
X
DESIGN**

- MINIMAL RESISTANCE BALL HOLDER ADJUSTMENT FROM 23" TO 33"
- STURDY X DESIGN WITH WEIGHTED LEGS FOR ADDED STABILITY
- HIGH IMPACT POST WITH FLEX JOINT
 - EASY TWIST AND LOCK HEIGHT
- 22IN (55.9CM) FOAM BAT AND BASEBALL



DESIGNED FOR THE BEGINNER, THIS TEE HAS A FLEXIBLE POST WHICH IS DESIGNED TO ABSORB THE MOMENTUM OF THE SWING AND REDUCE THE TEE FROM FALLING OVER. THE "X" BASE IS WEIGHT FOR ADDED STABILITY.

**FOLD AWAY
BATTING TEE** 

- INNOVATIVE FOLDING CASE KEEPS ALL COMPONENTS TOGETHER
- BUILT IN CARRY HANDLE MAKE TRAVEL EASY
- ACCESSORIES INCLUDE:
 - [1] OVERSIZED LIGHT WEIGHT BASEBALL BAT
 - [2] BASEBALLS

ITEM 64037
PACK 4

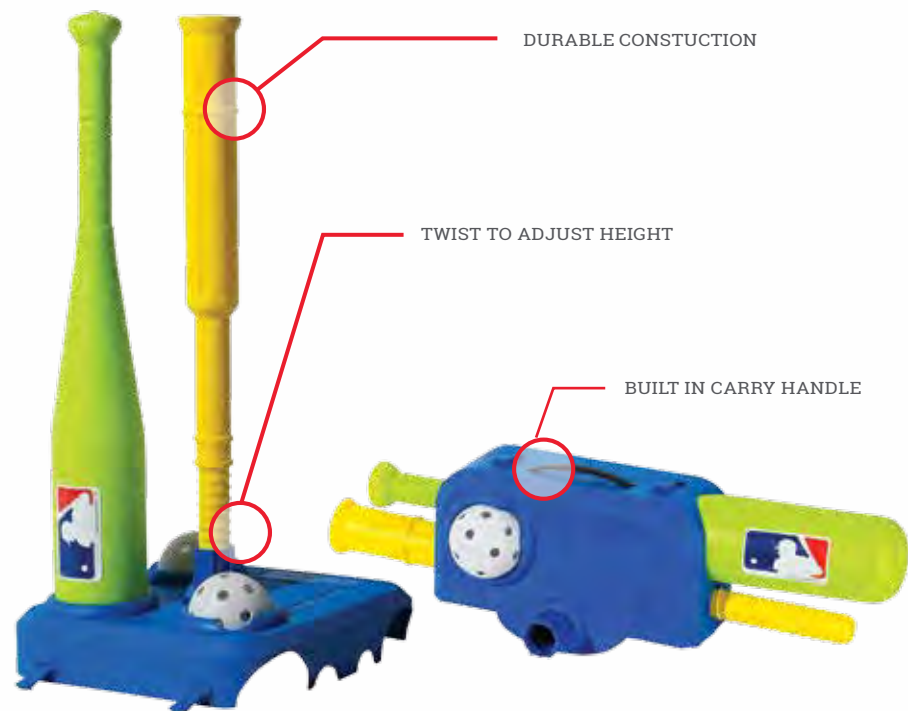

LEARN TO PLAY BASEBALL WITH THE FOLD-AWAY BATTING TEE. IT IS DESIGNED FOR THE FIRST TIME YOUTH PLAYER. THE OVERSIZED BAT MAKES HITTING EASY, GIVING KIDS THE CONFIDENCE TO LEARN AND ENJOY THE SPORT.



**PITCH RETURN
LINE UP**

			
ITEM	24806	24807	24804
SIZE	72" x 52"	68" x 48"	65" x 44"
			
ITEM	24859	19038	19083
SIZE	65" x 44"	61" x 44"	55" x 36"

SUPERIOR FEATURES



QUIKSET® ASSEMBLY
Corded frame and pre-attached bungees make set up easy

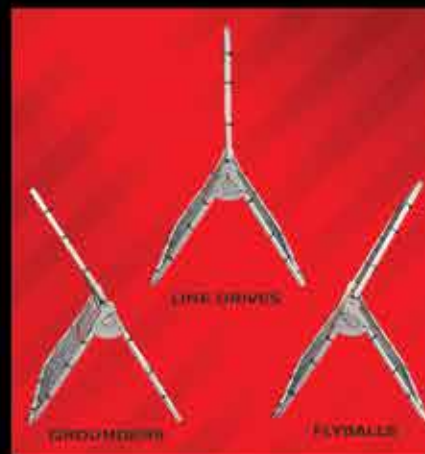

MULTI-ANGLE POSITIONING
Flawlessly convert angles for fly balls, line drives and ground balls



SWITCH-HITTER®
Flip style target adjusts for right and left handed batters

INNOVATION

TECHNOLOGY

PERFORMANCE

PROFESSIONAL MULTI-SPORT RETURN TRAINER

- ALL WEATHER CONSTRUCTION
- EASILY ADJUSTS FOR MULTIPLE RETURN ANGLES
- TWO-SIDED HEAVY-DUTY ALL-WEATHER 30-PLY PE NET WITH STRIKE-ZONE TARGET RIBBON
- FOLDS FLAT FOR EASY STORAGE

OFFERED IN 2 SIZES:

72" X 52" FRAME WITH 1.5" STEEL TUBE CONSTRUCTION

ITEM 24806
PACK 2

68" X 48" STEEL FRAME WITH 1.25" STEEL TUBE CONSTRUCTION

ITEM 24807
PACK 2

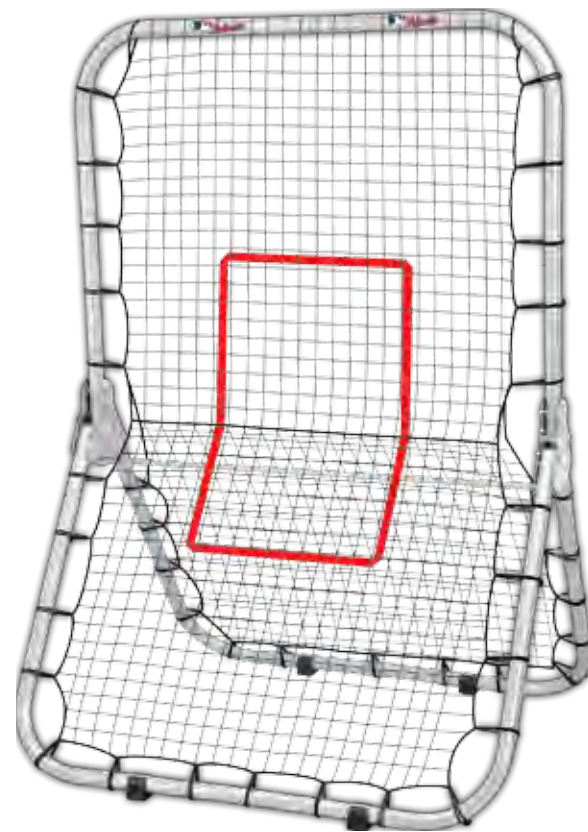

FRANKLIN'S TOP-OF-THE-LINE RETURN TRAINER IS MADE TO WITHSTAND HEAVY USE FROM PROFESSIONALS AND ELITE PLAYERS. IT IS DESIGNED FOR BOTH FIELDING AND PITCHING TRAINING



FLY BALLS



LINE DRIVES



GROUND BALLS

PROTECTIVE L-SCREEN

- L-SCREEN SIZE 78" X 72"
- INFIELDER'S SCREEN 72" X 36"
- ALL WEATHER CONSTRUCTION
- TWO SIDED HEAVY DUTY ALL-WEATHER NET

ITEM 1997
PACK 1



THIS DUAL USE DESIGN WORKS BOTH AS A L SCREEN FOR HITTING AND AS AN INFIELDER'S SCREEN



65" 2-IN-1 SWITCH-HITTER® PITCH TRAINER & RETURN TRAINER ALL IN ONE

- 65" X 44" FRAME SIZE 7/8" DIAM. STEEL CONSTRUCTION
- HEAVY-DUTY, ALL-WEATHER 24-PLY PE NET WITH TARGET RIBBON
- FLIP STYLE SWITCH-HITTER® PITCH TARGET ADJUSTS FOR RIGHT AND LEFT HAND BATTERS
- EASILY ADJUSTS FOR MULTIPLE RETURN ANGLES
- DURABLE 420D POLYESTER TARGET WITH BALL COLLECTION SYSTEM & REMOVABLE STORAGE BAG

ITEM 19069
PACK 2



SWITCH-HITTER® FLIP TARGET



THIS 2-IN-1 COMBO SET FEATURES A MULTI-POSITION BALL RETURN TRAINER ON ONE SIDE, WITH A PITCH TRAINER TARGET AND BALL-COLLECTION SYSTEM ON THE SECOND SIDE

FLYBACK® MULTI POSITION RETURN TRAINER

- SETS UP IN MINUTES!
- CORDED FRAME AND PRE-ATTACHED BUNGIES MAKES ASSEMBLY EASY
- 65IN X 44IN (165.1CM X 111.8CM)
- 3 ADJUSTABLE ANGLES
- ALL WEATHER 30-PLY PE NET
- INNOVATIVE CURVED RETURN DESIGN FOR MAXIMUM VERSATILITY

ITEM 24859
PACK 1

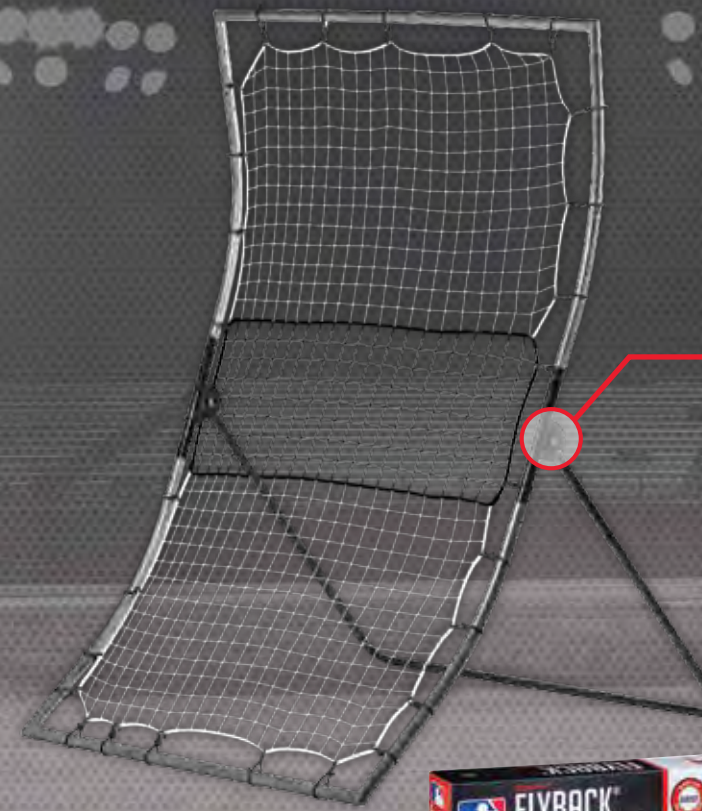

ADJUSTABLE ANGLES



QUIKSET DESIGN!



SETS UP AND BREAKS DOWN IN A MATTER OF MINUTES

55" 2-IN-1 SWITCH-HITTER® 

- 55" X 36" STEEL "Y" FRAME WITH 3/4" STEEL TUBING
- FLIP STYLE SWITCH-HITTER® PITCH TARGET ADJUSTS FOR RIGHT AND LEFT HAND BATTERS
- ALL WEATHER STEEL CONSTRUCTION
- HEAVY-DUTY, ALL-WEATHER 24-PLY PE NET WITH TARGET RIBBON

ITEM 24803
PACK 2



THIS 2-IN-1 COMBO SET FEATURES 3 WAY THROW & FIELD TRAINER ON ONE SIDE, WITH A PITCH TRAINER TARGET

61" MULTI-POSITION RETURN TRAINER 

- 61" X 44" STEEL "Y" FRAME WITH 1" STEEL TUBING
- ALL WEATHER STEEL CONSTRUCTION
- INFINITE POSITION "Y" FRAME DESIGN
- EASILY ADJUSTS WITH TENSION KNOB
- HEAVY DUTY ALL-WEATHER 30-PLY PE NET WITH TARGET RIBBON

ITEM 19038
PACK 2

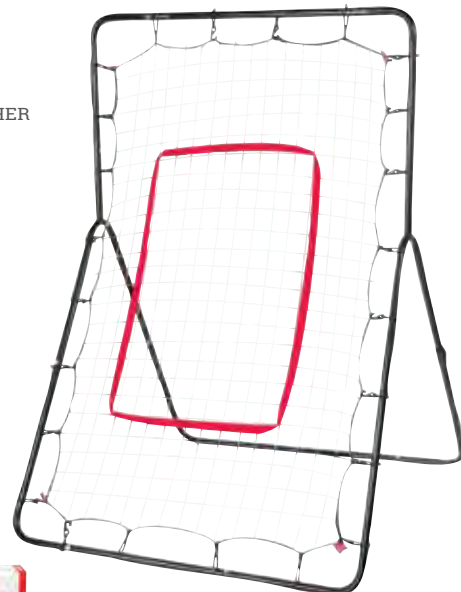

55" 3-WAY THROW AND FIELD TRAINER 

- 55" X 36" STEEL "Y" FRAME WITH 3/4" STEEL TUBING
- ALL WEATHER STEEL CONSTRUCTION
- HEAVY-DUTY, ALL-WEATHER 24-PLY PE NET WITH TARGET RIBBON

ITEM 19083
PACK 4

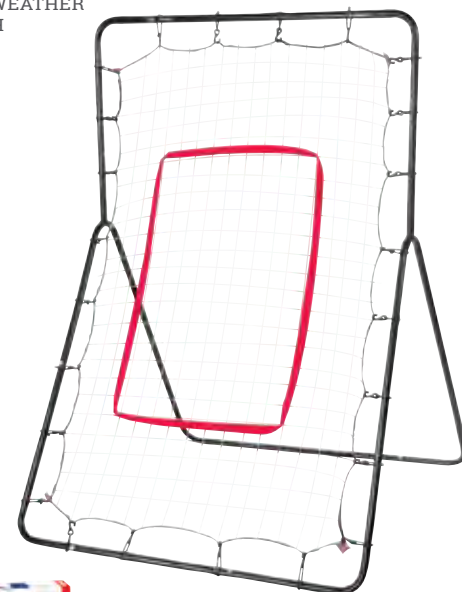

FLEXPRO® MULTI-SPORT TRAINING NET SYSTEM

- PITCH TARGET AND BACKSTOP
- INSTA-SET® DESIGN
- DURABLE STEEL & FIBERGLASS TENSION SYSTEM
- NETS STAYS TIGHT
- SETS UP QUICK AND EASY
- ULTRA-DURABLE DESIGN FOR HIGH-INTENSITY TRAINING
- INCLUDES REMOVABLE PITCHING TARGET AND CARRY BAG
- LIGHTWEIGHT DESIGN, EASY TO PACK, CARRY, AND STORE
- 7' X 7'



ITEM 24826
PACK 2



DESIGNED FOR BASEBALL, SOFTBALL, SOCCER, FOOTBALL AND LACROSSE



ALL SPORT BACKSTOP AND TARGET

- 10' H X 7' W FRAME
- IDEAL FOR BACKYARD OR ON-FIELD USE
- PORTABLE FOR BACKYARD AND FIELD USE
- HEAVY DUTY ALL WEATHER HEX MESH NET
- DURABLE FIBERGLASS CONSTRUCTION
- REMOVABLE TARGET WITH STRIKE ZONE
- NYLON CARRY BAG INCLUDED

ITEM 19060
PACK 4



ALL SPORT BACKSTOP AND TARGET, PERFECT FOR BASEBALL, SOFTBALL, SOCCER, LACROSSE, AND GOLF

ALL SPORT PRACTICE NET

- 8' H X 7' W FRAME, IDEAL FOR BACKYARD OR ON-FIELD USE
- ALL-WEATHER POLYESTER NET WITH 210D NYLON SLEEVE
- FIBERGLASS SUPPORT POLES AND GROUND STAKES INCLUDED
- NYLON CARRY BAG FOR EASY STORAGE AND TRANSPORTATION
- SOME ASSEMBLY REQUIRED

ITEM 19059S
PACK 3



PERFECT FOR BASEBALL, SOFTBALL, SOCCER, LACROSSE,



PITCHING MACHINES

PITCH-ROCKET® PITCHING MACHINE

- AUTHENTIC BASEBALLS PITCH 15- 50 MPH
- PRACTICE BALLS PITCH 15- 80 MPH
- POWER ADAPTOR INCLUDED
- ADULT SUPERVISION REQUIRED

MAIN UNIT WITH BALL FEEDER
ITEM 24834
PACK 1



RECOMMENDED AGE	8+ ADULT
SPEED RANGE	15-50 MPH (AUTHENTIC BASEBALL)
PITCH TYPE	FAST BALL
SPEED ADJUSTMENTS	DIAL
POWER SOURCE	110V HOUSEHOLD CURRENT
MOTOR	AC 1/4 HP, 3 AMP
WEIGHT	40 LBS
TRIPOD	STEEL LEGS
OPTIONAL AUTO FEED	YES; HOLDS UP TO 6 BALLS
BASEBALLS	SOLD SEPARATELY

AUTHENTIC BASEBALL PITCHING MACHINE
WITH ADJUSTABLE SPEED



VARIABLE SPEED DIAL



ELECTRIC POWERED
PLUGS INTO STANDARD OUTLET

STINGER® FOAM TRAINING PITCHING MACHINE

- ADJUSTABLE 3 SPEED PITCH CONTROLS- THROWS FAST BALLS AND LEFT HANDED OR RIGHT HANDED CURVE BALLS
- PITCHES UP TO 45 MPH
- GREAT FOR INDOOR OR OUTDOOR TRAINING
- USES 8.65" FOAM TRAINING BALLS
- DURABLE STEEL TRIPOD CONSTRUCTION
- ELEVATION ADJUSTMENT FOR FLY BALLS & GROUND BALL TRAINING
- POWER ADAPTOR INCLUDED.
- (3) BALLS INCLUDED

ITEM 24821
PACK 1

RECOMMENDED AGE	7+
SPEED RANGE	15-45 MPH
PITCH TYPE	FAST BALL & CURVE BALLS
SPEED ADJUSTMENTS	DIAL
POWER SOURCE	6V, 0.5A-MOTOR
ADAPTOR	120V AC 60HZ, OUTPUT: 120V DC 2000MA
TRIPOD	STEEL LEGS
BALL CAPACITY	YES; HOLDS UP TO 8 BALLS
BALL TYPE	70MM FOAM TRAINING



ELEVATION ADJUSTMENT FOR FLY BALLS AND GROUND BALL TRAINING



STINGER® FOAM TRAINING BALLS

- 8.65" HIGH DENSITY DIMPLED

ITEM 24838
PACK 6



PRO STEP-N-HIT®

- USE WITH AUTHENTIC & TRAINING BASEBALLS
- ADJUSTABLE BALL HEIGHT POSITION
- DURABLE ABS CONSTRUCTION
- FEEDER HOLDS 9 BASEBALLS FOR CONTINUOUS PLAY
- BALLS SOLD SEPARATELY
- NO BATTERIES REQUIRED

ITEM 6581
PACK 2



**IMPROVES
SWING MECHANICS
AND HAND-EYE
COORDINATION**



AUTO TEE 

- TEE UP BASEBALLS AUTOMATICALLY
- ARM RELEASES BALL EVERY 8 SECONDS
- NEVER BEND OVER TO SET THE BALL AGAIN
- USE AUTHENTIC SIZE BASEBALLS
- EASY ADJUSTS FROM 22" TO 32"
- SWING WITHOUT BREAKING YOUR STANCE
- INCLUDES BATTING TEE OR DISCONNECT TO USE WITH YOUR OWN TEE
- GROUND STAKES INCLUDED FOR ADDED STABILITY
- REQUIRES [4] "C" ALKALINE BATTERIES – NOT INCLUDED
- AGES 6+



ASSEMBLED SIZE:
40.5" X 32" X 21.6"

ITEM 64014
PACK 2



PITCHING MACHINE 

- BALL PITCHES EVERY 7 SECONDS
- PITCH ANGLE ADJUSTMENT
- RED LIGHT FLASHES TO INDICATE PITCH RELEASE
- [6] AERO-STRIKE® PLASTIC BASEBALLS
- REQUIRES [4] "D" ALKALINE BATTERIES – NOT INCLUDED
- BAT SOLD SEPARATELY
- AGES 6+

ITEM 6696S3
PACK 2



ASSEMBLED SIZE:
17.75" X 9.5" X 9.88"

**PITCH-N-HIT®
PITCHING MACHINE SET** 

- 3 POSITION PITCH ANGLE ADJUSTMENT
- BALL PITCHES EVERY 5 SECONDS
- BALL FEEDER HOLDS 9 BALLS
- INCLUDES [3] PLASTIC BASEBALLS AND (1) PLASTIC BAT
- REQUIRES [4] "D" ALKALINE BATTERIES – NOT INCLUDED
- AGES 6+

ITEM 19887
PACK 2



ASSEMBLED SIZE:
12" X 25.75" X 18"

**SUPER STAR BATTER®
BATTER AND FIELDER** 

- TRIPOD STYLE BASE RAISES THE MACHINE TO THE PROPER PITCH LEVEL
- TELESCOPIC BALL FEEDER EXPANDS TO HOLD 9 BALLS
- INCLUDES [6] AERO-STRIKE® PLASTIC BASEBALLS
- REQUIRES [4] "C" ALKALINE BATTERIES – NOT INCLUDED
- AGES 6+
- BAT SOLD SEPARATELY

ITEM 14071
PACK 2

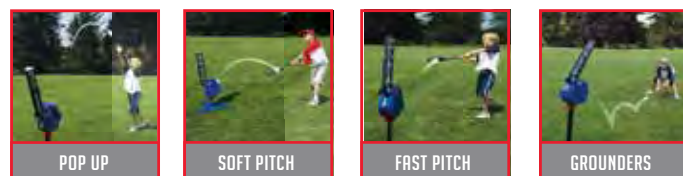

MULTI FUNCTION 4 IN 1 PITCHING MACHINE. PERFECT FOR BUILDING CONFIDENCE AND SKILLS IN YOUNG PLAYERS EASILY ADJUSTS TO PRACTICE

**THREE STRIKES®
BASEBALL** 

- EASILY CONVERTS BETWEEN GAME PLAY
- GREAT FOR TEACHING HAND AND EYE COORDINATION
- (3) SOFT PLASTIC BASEBALLS
- PLASTIC 26" BASEBALL BAT INCLUDED
- REQUIRES 4 "C" SIZE BATTERIES NOT INCLUDED
- AGES 3+

ITEM 14912
PACK 3



LEARN TO BE A FUTURE CHAMP! 3 LEVELS OF PLAY
ADJUSTABLE TEE-BALL - SOFT-TOSS® BASEBALL
AUTO PITCH BASEBALL

**SUPER STAR BATTER®
2 IN 1 TEEBALL** 

- FEATURES A DURABLE FLEX BASE
- DURABLE HIGH IMPACT ABS CONSTRUCTION
- HEIGHT ADJUSTS FROM 21" TO 25"
- AGES 3+

ITEM 14933
PACK 6



ASSEMBLED SIZE:
11.5" X 25" X 16.5"

TWO FUN WAYS TO LEARN TO PLAY BASEBALL. KIDS START BY HITTING FROM THE TEE. ONCE THEY GAIN CONFIDENCE AND ARE READY FOR MORE DIFFICULTY, SIMPLY REMOVE THE "T" ATTACHMENT TO REVEAL THE POP-UP. SIMPLY STEP ON THE HOME PLATE OR 3RD BASE. PERFECT FOR BOTH RIGHT AND LEFT HANDED HITTERS

**POP A PITCH
PITCHING MACHINE** 

- BASEBALL TRAINER HELPS BUILD HAND & EYE COORDINATION SKILLS
- EASY STEP, POP, SWING MOTION
- DURABLE ABS PLASTIC CONSTRUCTION
- 3 AERO-STRIKE® PLASTIC BASEBALLS
- 25" COLLAPSIBLE TELESCOPIC PLASTIC BAT
- AUTO BALL FEEDER FOR MULTIPLE SWING ACTION PRACTICE
- ASSEMBLES IN SECONDS
- AGES 6+

ITEM 14001S
PACK 6



**IMPROVES
HAND-EYE
COORDINATION**

YOUTH PLAYER
WOOD STARTER SET

- WOOD BAT, GLOVE, AND BALL SET
- 9" PVC BASEBALL GLOVE
- OFFICIAL SIZE SOFT STRIKE BALL
- 25" ALUMINUM TEEBALL BAT (-10 DROP)
- ASSORTED COLORS

ITEM 24849
PACK 4



SOLID WOOD
TEEBALL BAT & BALL SET

- 25" SOLID WOOD BAT (-14)
- OFFICIAL SIZE SOFT STRIKE® BALL
- FOR SOFT STRIKE® TEEBALL USE ONLY
- ASSORTED COLORS

ITEM 1909S3
PACK 6



INFERNO
TEEBALL BAT

- 24IN, 25IN & 26IN TEEBALL BATS (-10)
- 6061 T4 ALUMINUM CONSTRUCTION
- DUAL COLOR PU BAT GRIP
- FOR SOFT STRIKE® TEEBALL USE ONLY



ITEM	LENGTH	COLOR	WEIGHT	BARREL	PACK
23345C2	26"	BLUE	16oz	2 1/4"	4
23347C1	25"	GREEN	15oz	2"	4
23347C2	25"	BLUE	15oz	2"	4
23347C13	25"	PINK	15oz	2"	4
23348C1	24"	GREEN	14oz	2"	4

PRO-ELITE
THIN BAT SWING TRAINER

- 30" LENGTH ALUMINUM CONSTRUCTION WITH 1 1/8" BAT BARREL
- LIGHTWEIGHT DESIGN ALLOWS FOR MORE SWINGS AND LESS FATIGUE
- PU BAT GRIP
- FOR USE WITH PLASTIC TRAINING BALLS (FRANKLIN ITEM #10364, 10397 OR 1511)
- INCLUDES 3 PLASTIC TRAINING BALLS

ITEM 19058
PACK 4



DESIGNED TO IMPROVE BATTING SKILLS AND HAND-EYE COORDINATION BY USING A SMALLER BALL AND SMALLER BAT BARREL



SPIN TECH™ TECHNOLOGY

PITCH LIKE THE PROS AND HIT FOR THE FENCES! THE NEW MLB® CURVE BALL ALLOWS ANYONE TO THROW CURVES, SLIDERS AND KNUCKLEBALLS. THE 27" AIR COMPRESSED BAT FEATURES A HUGE SWEET SPOT FOR MASSIVE HITTING POWER! THE BALL IS SPECIALLY FORMULATED TO CRUSH ON IMPACT MAKE BACKYARD PLAY MORE COMPETITIVE AND LONGER LASTING.



CHECK OUT
IN ACTION!

33.5" SPIN TECH™ PRO BAT & BALL

- PRO STYLE BAT WITH RUBBER GRIP
- PLASTIC SPIN TECH BALL
- ASSORTED COLORS
- AGES 8+

ITEM 64048
PACK 6



SPIN TECH™ BALL & BAT SET

- PRO STYLE BAT WITH RUBBER GRIP
- PLASTIC SPIN TECH BALL
- ASSORTED COLORS
- AGES 8+

ITEM 64038A
PACK 6



POWERHOUSE BASEBALL BAT AND BALL

WITH ADJUST-A-HIT® TECHNOLOGY

- ELIMINATES CHOKING UP ON THE HANDLE FOR CUSTOM FIT
- EASILY ADJUSTS WITH A TWIST AND LOCK MOTION FROM 21" TO 27" IN LENGTH
- DIGITAL PVC GRIP
- SOFT PU FOAM BASEBALL
- ASSORTED COLORS: RED AND BLUE
- AGES 6+

ITEM 14902
PACK 6



OVERSIZED FOAM BAT AND BALL

- 24" OVERSIZED SOFT RUBBER FOAM BARREL
- BLOW-MOLDED INNER CORE
- SOFT FOAM GRIP
- ASSORTED COLORS
- AGES 3+

ITEM 6601S3
PACK 4



JUMBO PLASTIC BAT

- SOFT FOAM GRIP!
- 3.25" JUMBO SIZE BARREL
- ASSORTED COLORS: RED, BLUE, GREEN, ORANGE
- AGES 3+

ITEM 6467S3
PACK 4



MINI FOAM BAT AND BALLS

- 20" MINI SOFT FOAM BASEBALL BAT & BALL
- AGES 3+

ITEM 64024A
PACK 6



BASEBALLS

PRACTICE

COVER: SYNTEX SYNTHETIC
CORE: CORK/RUBBER
SEAM: FLAT

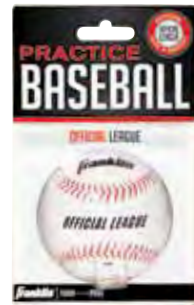

BULK
1532 | PACK 12



MESH BAG
23310 | PACK 4



PDQ
1538D12 | PACK 12

OFFICIAL LEAGUE

COVER: LEATHER
CORE: CORK/RUBBER/5% WOOL
SEAM: FLAT

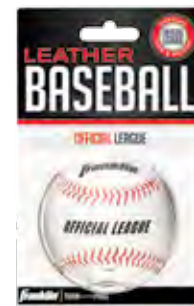

BULK
1534Z | PACK 12

BLISTER
1534 | PACK 12

TOURNAMENT PLAY

COVER: COWHIDE LEATHER
CORE: DOUBLE CUSHIONED CORK
/15% WOOL
SEAM: RAISED



BULK
1570Z | PACK 12

BLISTER
1570 | PACK 12



PDQ
1570D12 | PACK 12

SOFTBALLS

PRACTICE 12.0"

COVER: SYNTEX SYNTHETIC
CORE: SOLID CORK
SEAM: FLAT

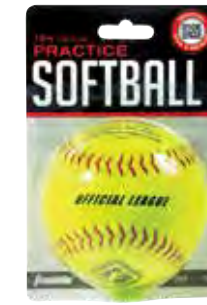

BULK 1550 | PACK 12
BLISTER 10981 | PACK 12



MESH BAG
1550S | PACK 3



PDQ
1550D12 | PACK 12

SOFT STRIKE® 12.0"/11.0"

COVER: SYNTEX SYNTHETIC
CORE: SOLID RUBBER SPONGE
SEAM: FLAT



12.0" BULK
10985 | PACK 12



11.0" BULK
10986 | PACK 12

TOURNAMENT PLAY - FASTPITCH/SLOWPITCH

COVER: SYNTEX SYNTHETIC
CORE: SOLID PU
SEAM: FLAT



FASTPITCH BLISTER
10984 | PACK 12



SLOWPITCH BLISTER
10983 | PACK 12

TEEBALLS

SOFT STRIKE®

COVER: SYNTEX SYNTHETIC
CORE: SOLID RUBBER SPONGE



BULK 1920Z | PACK 12
BLISTER 1920 | PACK 12



MESH BAG
23313 | PACK 4



PDQ
1920D12 | PACK 12

TEEBALLS

RUBBER

CORE: SOLID RUBBER SPONGE



BLISTER
1915 | PACK 12



PDQ
23309 | PACK 12

SOFT STRIKE® CHROME

COVER: SYNTEX SYNTHETIC
CORE: SOLID RUBBER SPONGE



MESH BAG
23340 | PACK 6



PDQ
23339S4 | PACK 12

PROBRITE RUBBER

CORE: SOLID RUBBER SPONGE



MESH BAG
23374P6 | PACK 6



PDQ
23342S4 | PACK 12

SOFT STRIKE® GLOMAX®

COVER: SYNTEX SYNTHETIC
CORE: SOLID RUBBER SPONGE



CLAM
23343 | PACK 12



PDQ
23373 | PACK 12

GLOWS
IN THE
DARK!



PROBRITE

EXPERIENCE THE COLOR

HOME RUN

BUILD STRENGTH & POWER TO YOUR SWING THROUGH FOCUSED RESISTANCE TRAINING



CHECK OUT
THE HOME RUN BALL
IN ACTION!

HOME RUN
TECHNOLOGY

HIT THE BALL HARDER AND FURTHER THAN EVER BEFORE BY INCORPORATING STRENGTH TRAINING INTO YOUR DAILY PRACTICE REGIMEN. PROMOTES PROPER HIP ROTATION AND STRONG FOLLOW THROUGH ON THE BALL

12.5 X TRAINING BALL

WEIGHT: 12.5 OZ
SIZE: 3.8" DIAMETER
TARGET: BAT SPEED

SINGLE ITEM 24823
PACK 6 3 PACK ITEM 24860
PACK 1



12.5oz
2.5X
SPEED

17.5 X TRAINING BALL

WEIGHT: 17.5 OZ
SIZE: 6" DIAMETER
TARGET: BAT STRENGTH

ITEM 24820
PACK 3



17.5oz
3.5X
STRENGTH

22.5 X TRAINING BALL

WEIGHT: 22.5 OZ
SIZE: 6" DIAMETER
TARGET: BAT POWER

ITEM 24840
PACK 3



22.5oz
4.5X
POWER

STRENGTH BUILDING SET

ADVANCED STRENGTH BUILDING SYSTEM

SET INCLUDES:
[1] 12.5 OZ, [1] 17.5 OZ,
AND [1] 22.5 OZ
TRAINING BALL

ITEM 24846
PACK 3



WEIGHTED BASEBALL & SOFTBALL



FRANKLIN'S WEIGHTED BALLS ARE DESIGNED FOR BUILDING ARM STRENGTH THROUGH VARIOUS PITCHING AND THROWING DRILLS.

OFFICIAL LEAGUE SIZE AND SHAPE

10 OZ. WEIGHTED BASEBALL/SOFTBALL

BASEBALL ITEM 1052
PACK 12

SOFTBALL ITEM 2115
PACK 12



HYPERLYTE™

COVER: SYNTHETIC HOLOGRAM
CORE: PU FOAM

SUPER LIGHT-WEIGHT BASEBALL
AUTHENTIC SIZE



3 PACK 64057
PACK 12



PDQ 23357
PACK 12

OVERSIZED FOAM BASEBALLS



3 PACK
CLAM 14928
PACK 6



4 PACK
MESH BAG 64025
PACK 4



CLAM 14929
PACK 6

FOAM BASEBALL



INDESTRUCT-A-BALL™

THE ORIGINAL
INDESTRUCT-A-BALL® HEAVY DUTY LIMITED FLIGHT BASEBALLS!

THE INDESTRUCT-A-BALL® IS ENGINEERED TO KEEP ITS SHAPE AND PREVENT CRACKING LIKE STANDARD PRACTICE BALLS, EVEN AFTER THOUSANDS OF HITS. THE PROPRIETARY FORMULA WAS CREATED TO FLEX ON IMPACT TO PREVENT CRACKING ALONG WITH REDUCING TRAVEL DISTANCE.

- EXTREMELY DURABLE AND BUILT TO LAST THOUSANDS OF HITS!
- EASY USE WITH ALL BAT TYPES
- PROVIDES HITTERS INSTANT FEEDBACK ON CONTACT



- LIMITED FLIGHT DESIGN FOR EASIER RETRIEVAL
- HAS TESTED TO LAST 5X LONGER THAN TRADITIONAL PLASTIC PRACTICE BALLS
- EACH INCLUDES PLEASURABLE GROWSTHING TRAVEL BING

MINI BALL

COLOR: WHITE



ITEM 10397P6
PACK 6

OVERSIZED BASEBALL

COLOR: OPTIC YELLOW



ITEM 10361P6
PACK 6

BASEBALLS



OPTIC YELLOW
ITEM 10362P6
PACK 6



WHITE
ITEM 10363P6
PACK 6



WHITE 24 CT. BUCKET
ITEM 24828
PACK 1

AERO-STRIKE® PLASTIC SOFTBALL

ITEM 19884A
PACK 6



AERO-STRIKE® PLASTIC BASEBALL

ITEM 19885A
PACK 6



TRAINING BALLS

AERO-STRIKE® NO-HOLE BASEBALL

ITEM 14938P6
PACK 6



SPIN TECH

PITCH LIKE THE PROS!
MAKES THROWING SLIDERS, CURVEBALLS AND KNUCKLEBALLS EASY!



2 PC CLAM 64043
PACK 6



PDQ 64058
PACK 12



PRO-ELITE SPIKE DOWN
19" HOME PLATE 

- 19" REGULATION SIZE, SPIKE DOWN HOME PLATE
- HEAVY DUTY, 2-STAGE INJECTION MOLDED, WEATHER-RESISTANT RUBBER CONSTRUCTION
- IDEAL FOR BASEBALL AND SOFTBALL LEAGUES
- INCLUDES FIVE SCREW-IN SPIKES

ITEM 1981
PACK 2



PRO-ELITE SPIKE DOWN
24" PITCHER'S RUBBER 

- 24" X 6" HEAVY DUTY WEATHER-RESISTANCE CONSTRUCTION
- IDEAL FOR BASEBALL AND SOFTBALL LEAGUES

ITEM 23354
PACK 3



DELUXE SPIKE DOWN
18" PITCHER'S RUBBER 

- 18" X 4" HEAVY DUTY WEATHER-RESISTANT CONSTRUCTION
- IDEAL FOR BASEBALL AND SOFTBALL LEAGUES

ITEM 23355
PACK 3



DELUXE THROW DOWN
RUBBER BASE SET 

- 4-PIECE, WEATHER-RESISTANT RUBBER BASE SET
- HEAVY-DUTY, WAFFLE CONSTRUCTION FOR IMPROVED GRIP ON PLAYING SURFACES
- INCLUDES HOME PLATE AND THREE BASES
- PERFECT FOR YOUTH LEAGUES, PRACTICE FIELDS, AND BACKYARD USE

ITEM 1986
PACK 3



THROW DOWN
RUBBER-TEK™ BASE SET 

- 5-PIECE WEATHER-RESISTANT RUBBER-TEK™ SET
- INCLUDES HOME PLATE, PITCHER'S RUBBER, AND THREE BASES
- PERFECT FOR PRACTICE FIELDS AND BACKYARD USE

ITEM 1985
PACK 6

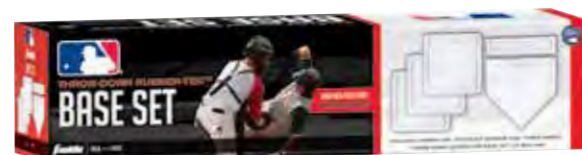

DELUXE HI VIZ
17" PITCHER'S TRAINING PLATE 

- THE PRINTED DESIGN HELPS PITCHERS FIND THE ZONES AND VISUALLY TARGET THE OUTSIDE OF THE PLATE.
- 17" REGULATION SIZE, THROW DOWN HOME PLATE
- HEAVY-DUTY, WEATHER-RESISTANT RUBBER CONSTRUCTION
- WAFFLE BOTTOM FOR IMPROVED GRIP ON PLAYING SURFACES
- IDEAL FOR BASEBALL AND SOFTBALL LEAGUES

ITEM 23338
PACK 2



GLOW IN THE DARK THROW DOWN
RUBBER-TEK™ BASE SET 

- 5-PIECE WEATHER-RESISTANT RUBBER-TEK™ SET
- INCLUDES HOME PLATE, PITCHER'S RUBBER, AND THREE BASES
- PERFECT FOR PRACTICE FIELDS AND BACKYARD USE

ITEM 23352
PACK 6



DR. GLOVE® CONDITIONING & RELACING KIT

- THREE 6' ROLLS OF RAWHIDE LACE
- 1 WOODEN HANDLE LEATHER PUNCH
- 1 WOODEN HANDLE LACING TOOL
- 1 U-WIRE LACING NEEDLE
- 2 OZ. DR. GLOVE® CONDITIONING GLOVE OIL
- 1 HAND MITT
- 1 CLEANING BRUSH

ITEM 1569
PACK 6



DR. GLOVE® DELUXE RELACING KIT

- NON SLIP POLYURETHANE COATED LACING NEEDLE
- 4' OF RAWHIDE LEATHER LACE
- 10 TAN, 2 BLACK

ITEM 2753
PACK 12



FIELDING TRAINER

- DURABLE, EVA FOAM CONSTRUCTION WITH CONTOURED BACK
- THICK FOAM TAKES THE "STING" OUT OF HARD HIT BALLS
- ONE SIZE FITS MOST, FOR BOTH LEFT AND RIGHT-HANDED PLAYERS

ITEM 19171
PACK 6



THE FRANKLIN FIELDING TRAINER HELPS DEVELOP PROPER FIELDING MECHANICS BY TEACHING INFELDERS TO ABSORB THE IMPACT OF GROUND BALLS WITH 'SOFT HANDS'

DELUXE FLIP-UP SUNGLASSES

- FLIP-UP DESIGN
- IMPACT-RESISTANT POLYCARBONATE FRAME AND LENS
- UVA AND UVB PROTECTION
- BLUE MIRRORED LENS
- INCLUDES CARRY POUCH AND HEADBAND STRAP

ITEM 19180
PACK 12



DR. GLOVE® GLOVE OIL CONDITIONER

- 3OZ

ITEM 10398
PACK 12



DR. GLOVE® FOAM GLOVE CONDITIONER

- 1.75 OZ. FOAM DISPENSER
- MADE IN THE USA

ITEM 10409
PACK 12



LIGHTER WEIGHT FORMULA DESIGNED TO HELP BREAK-IN, CONDITION, AND PRESERVE LEATHER FIELDING GLOVES. PERFECT SOLUTION TO KEEP THE GLOVE IN TOP CONDITION AFTER PLAY OR PRACTICE

DR. GLOVE® CONDITIONING GLOVE OIL WIPES

- 12 COUNT TRAVEL PACK
- DISPOSABLE GLOVE WIPES
- EASY APPLICATION
- SOFTENS LEATHER & CLEANS LEATHER GLOVES
- USE BEFORE AND AFTER PLAY

ITEM 23315
PACK 8



EASY TO USE, ALL IN ONE SYSTEM! EACH WIPE CONTAINS THE PROPER AMOUNT OF OIL FOR ONE APPLICATION FOR A 12" GLOVE.

PERFECT SOLUTION TO KEEP THE GLOVE IN TOP CONDITION AFTER PLAY OR PRACTICE

BAT WEIGHTS

- CAST IRON WEIGHT WITH NON-SLIP POLYURETHANE COATING

OFFERED IN 2 WEIGHTS:



16 OZ. ITEM 1970
PACK 12



20 OZ. ITEM 2764
PACK 12

HEAVY-HITTER® BAT WEIGHT SYSTEM

- IMPROVES BAT SPEED AND POWER
- BUILD YOUR CUSTOM WEIGHT
- MAGNETIC CONNECTION
- FITS REGULATION 2 5/8" BARREL BATS FOR SOFTBALL AND BASEBALL BATS
- SET INCLUDES [2] 4OZ, [1] 5OZ AND [1] 7OZ TO CREATE A VARIETY OF CONFIGURATIONS RANGING FROM 4 TO 20OZ.

ITEM 23349
PACK 6



4oz	4 + 5 = 9oz
5oz	5 + 7 = 12oz
7oz	7 + 5 + 4 = 16oz
4 + 4 = 8oz	7 + 5 + 4 + 4 = 20oz

COACH'S CLIPBOARD

- DRY ERASE CLIPBOARD INCLUDES MARKER AND FELT ERASER
- INCLUDES LINE UP AND FIELD LAYOUT

OFFERED IN 2 SIZES:

11" X 7.5"

ITEM 1567
PACK 6

15.75" X 9"

ITEM 113686
PACK 6



DESIGNED FOR DUGOUT PLAY AND POSITION ANALYSIS

BASEBALL/SOFTBALL SCOREBOOK

- SCORES UP TO 50 GAMES
- EASY-TO-FOLLOW SCORING INSTRUCTIONS
- ONE-PAGE FORMAT TRACKS BATTING, FIELDING, AND PITCHING STATISTICS

ITEM 19187
PACK 12



SHOK-SORB® BAT GRIP

- ASSORTED COLORS
- 1.2MM THICKNESS
- 99CM LENGTH

ITEM 23368
PACK 6



SYNTHETIC BAT GRIP

- 41" X 1" POLYURETHANE NON-SLIP BAT GRIP
- INCLUDES FINISHING TAPE

ITEM 2749
PACK 12



LINE UP CARDS

- PROTECTIVE FLIP-BOOK DESIGN
- LINES FOR UP TO 18 PLAYERS AND SUBSTITUTES
- LINE-UP CARDS FOR UP TO 20 GAMES
- EACH GAME INCLUDES ONE ORIGINAL LINEUP AND THREE TEAR-OUT CARBON-COPIES

ITEM 19186
PACK 12



BAT TAPE

- 360" X 1" BLACK SPORT TAPE
- MADE IN THE USA

ITEM 1917
PACK 12



SHOK-SORB® STING REDUCER

- EASILY ATTACHES TO THUMB FOR A COMFORT FIT
- PROVIDES IMPROVED BAT GRIP AND STING REDUCER
- ASSORTED COLORS

ITEM 10329
PACK 12



SHOK-SORB® BAT NUB

- ATTACHES TO THE NUB OF THE BAT TO PROVIDE IMPROVED BAT GRIP AND HELPS REDUCE STING
- ASSORTED COLORS

ITEM 10378
PACK 12



EYE BLACK

- REDUCES GLARE FROM SUN AND OVERHEAD LIGHTS
- NON-TOXIC BEE'S WAX BASE
- EASY APPLICATION AND REMOVAL

ITEM 2759
PACK 12



4IN WRISTBANDS

- 4" PRO-STYLE WRISTBANDS
- EXTRA-ABSORBENT AND BREATHABLE TERRY-COTTON DESIGN
- SOLD IN PAIRS

PACK 12



BLACK
ITEM 23350C1



BLUE
ITEM 23350C3



RED
ITEM 23350C2



WHITE
ITEM 23350C4



UMPIRE SCOREKEEPER

- 4-WAY NYLON SCOREKEEPER
- RECORDS BALLS, STRIKES, INNINGS, AND OUTS

ITEM 1978
PACK 12



UMPIRE BRUSH

- 4" WOODEN PLATE BRUSH WITH NYLON BRISTLES

ITEM 2756
PACK 12



6IN WRISTBANDS

- 6" PRO-STYLE WRISTBANDS
- EXTRA-ABSORBENT AND BREATHABLE TERRY-COTTON DESIGN
- SOLD IN PAIRS

PACK 12



BLACK
ITEM 23351C1



BLUE
ITEM 23351C3



RED
ITEM 23351C2



WHITE
ITEM 23351C4



PITCH COUNTER

- RECORDS NUMBER OF PITCHES THROWN
- CLEAR, 4-DIGIT READOUT

ITEM 1522
PACK 12

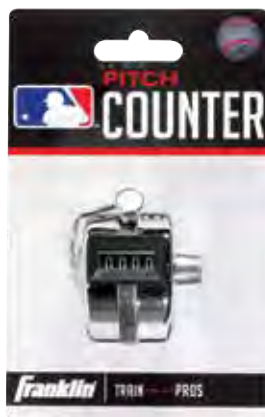

ROSIN BAG

- DRY GRIP ENHANCEMENT
- NON-TOXIC
- IDEAL FOR BASEBALL, SOFTBALL, AND OTHER SPORTS

ITEM 1968
PACK 12



BASEBALL/SOFTBALL BELT

- ONE SIZE FITS MOST (22" TO 42" WAIST)
- NEW 1.25" WIDTH, RUBBER/POLYESTER WOVEN ELASTIC CONSTRUCTION FITS MOST PANTS
- LEATHER TAB WITH STEEL HARDWARE

PACK 12



BLACK
ITEM 1062CQ



BLUE
ITEM 1062BV



RED
ITEM 1062BK



GRAY
ITEM 1062BW

SLINGBAK 

- RETRACTABLE BAT STORAGE COMPARTMENT
- CONVENIENT SLING-STRAP FOR EASY PORTABILITY
- LARGE COMPARTMENT FOR HELMET AND ACCESSORIES
- BAG SIZE: 18.5IN X 13IN X 8IN (47CM X 33CM X 20.3CM)

ITEM TBD
PACK 6



FRANKLIN'S PERFORMANCE EQUIPMENT BAGS

THIS SERIES COMBINES SLEEK, MODERNIZED LOOKS WITH MAXIMUM-PERFORMANCE AND FUNCTIONALITY-ORIENTED DESIGNS. THESE BAGS ARE PERFECT FOR PROTECTING, STORING, AND TRANSPORTING ALL OF YOUR EQUIPMENT NEEDS FOR RECREATIONAL, PRACTICE, OR GAME-DAY EVENTS.

JUNIOR EQUIPMENT BAG 

- VENTILATED CLEAT STORAGE COMPARTMENT
- SEPARATE BAT POCKET STORES UP TO (3) BATS
- BAG SIZE: 34" X 9" X 6"

ITEM 23360C1
PACK 6



BATPACK 

- OUTER POCKETS FOR STORAGE OF UP TO (2) BATS
- FRONT ACCESSORY POCKETS IDEAL FOR KEYS, ID, AND VARIOUS SMALL ITEMS
- BACKPACK-STYLE SHOULDER STRAPS FOR EASY AND CONVENIENT TRANSPORTATION
- BAG SIZE: 19.25" X 14" X 7.25"

ITEM 23359C2
PACK 6



FLEXPRO® CUP & COMPRESSION SHORT 

- FLEXPRO® CUP PROVIDES PROTECTION FOR HIGH IMPACT SPORTS
- SOFT TPR PADDED GEL EDGES
- NATURAL FIT COMFORT CREASE OFFERS ENHANCED MOBILITY
- VENTED AIR COOLED COMFORT DESIGN

PACK 2



VENTED DESIGN WITH SOFT PADDED EDGES



MID LENGTH CUT MULTI-SPORT COMPRESSION SHORT DESIGNED SPECIFICALLY FOR ACTIVITIES THAT REQUIRE ADDITIONAL MUSCLE SUPPORT AND THE PROTECTION OF A 'HARD' CUP.

YOUTH SM/MD

ITEM 5377F2S4P2/0103

YOUTH LG/XL

ITEM 5377F4S4P2/0103

ADULT SM/MD

ITEM 5374F2S4P2/0103

ADULT LG/XL

ITEM 5374F4S4P2/0103

COMPRESSION SHORT

- DOUBLE LAYER GUSSET PROVIDES ADDED SUPPORT
- 1 1/2" PERFORMANCE PLUS ELASTIC WAISTBAND
- CAN BE USED WITH AND WITHOUT A CUP
- VENTED AVAILABLE IN YOUTH AND ADULT SIZES
- CUP NOT INCLUDED
- ASSORTED COLORS: BLACK X 1, WHITE X 2

PACK 3



MID LENGTH CUT MULTI-SPORT COMPRESSION SHORT. FOR MOST SPORTS AND ACTIVITIES THAT REQUIRE ADDITIONAL MUSCLE SUPPORT. THERAPEUTIC STRETCH FOR ADDED MUSCLE SUPPORT. INTERNAL CUP POUCH ENSURES A SECURE AND COMFORTABLE FIT.

YOUTH SM/MD

ITEM 38500F10

24" - 27"

YOUTH LG/XL

ITEM 38500F11

28" - 31"

ADULT SM

ITEM 38501F1

28" - 30"

ADULT MD

ITEM 38501F2

32" - 34"

ADULT LG

ITEM 38501F4

36" - 38"

ADULT XL

ITEM 38501F5

40" - 42"

YOUTH SLIDING SHORT

- 100% STRETCH POLYESTER CONSTRUCTION
- CONTOURED POCKET FOR A CUP (CUP NOT INCLUDED)
- 2" PRO STYLE FRANKLIN LOGO WAISTBAND FOR COMFORT AND SUPPORT
- 100% POLYESTER SPACER SLIDING PAD FOR ADDED PROTECTION

PACK 3



PLAYERS WILL LOVE THE COMFORT AND PROTECTION THIS FRANKLIN SLIDING SHORT PROVIDES. PERFECT FOR BASEBALL AND SOFTBALL.

YOUTH SM
ITEM 23321
WAIST 22" - 24"
AGE 6 - 9
WEIGHT 64 - 84lbs

YOUTH MD
ITEM 10333
WAIST 24" - 26"
AGE 9 - 11
WEIGHT 85 - 105lbs

YOUTH LG
ITEM 10334
WAIST 26" - 28"
AGE 11 - 13
WEIGHT 106 - 126lbs

YOUTH BASEBALL SOCKS

- FULL CUSHION FOOT WITH COMFORT ARCH SUPPORT
- OFFERED IN ASSORTED COLORS TO MATCH TEAM UNIFORMS
- DESIGNED FOR BETTER STAY UP PERFORMANCE
- IDEAL FOR A VARIETY OF SPORTS
- ASSORTED COLORS: NAVY X 2, BLACK X 2, ROYAL X 1, RED X 1

PACK 6



THESE SOLID COLORED GAME SOCKS PROVIDE COMFORT AND SUPPORT WHERE ATHLETES NEED IT MOST.

YOUTH SM
ITEM 10325
SHOE SIZE 10 - 1

YOUTH MD
ITEM 10326
SHOE SIZE 2 - 5

YOUTH LG
ITEM 10327
SHOE SIZE 6 - 10

YOUTH DELUXE BASEBALL PANT

- DURABLE DOUBLE KNIT STRETCH POLYESTER
- 5/8" BELT LOOP TUNNEL
- ELASTIC WAISTBAND FOR COMFORT FIT
- NON RUSTING SNAP BUTTONS
- METAL ZIPPER FLY FRONT
- DOUBLE KNEE CONSTRUCTION
- TWO SET IN BACK POCKETS
- ELASTIC HEM
- * BELT NOT INCLUDED

PACK 3



SUPERIOR FEATURES



Comfort fit waistband with belt loop and tunnel

Dourable double knees

2 Set-in pockets with Franklin embroidered logos

GRAY XS
ITEM 10365

GRAY SM
ITEM 10366

GRAY MD
ITEM 10367

GRAY LG
ITEM 10368

GRAY XL
ITEM 10369

WHITE XS
ITEM 10355

WHITE SM
ITEM 10356

WHITE MD
ITEM 10357

WHITE LG
ITEM 10358

WHITE XL
ITEM 10359

WAIST 20" - 22"
AGE 4 - 6
WEIGHT 46 - 63lbs

WAIST 22" - 24"
AGE 6 - 9
WEIGHT 64 - 84lbs

WAIST 22" - 24"
AGE 6 - 9
WEIGHT 64 - 84lbs

WAIST 22" - 24"
AGE 6 - 9
WEIGHT 64 - 84lbs

WAIST 22" - 24"
AGE 6 - 9
WEIGHT 64 - 84lbs

TEAM SOFT STRIKE®
CITY BASEBALLS

- METALLIC AND PEARL PVC COVERS WITH OFFICIAL TEAM LOGOS
- SOFT SPONGE CORE

ITEM 2710FFX (TEAM STYLE #F01-F31)
PACK 12



ALL TEAM
LOGO BASEBALL

- CITY THEMED PVC COVERS WITH OFFICIAL TEAM LOGOS
- SOFT SPONGE CORE

ITEM 76007
PACK 12



	TEAM	TEAM CODE
	BALTIMORE ORIOLES	F01
	BOSTON RED SOX	F02
	ANGELS BASEBALL	F03
	CHICAGO WHITE SOX	F04
	CLEVELAND INDIANS	F05
	DETROIT TIGERS	F06
	KANSAS CITY ROYALS	F07
	MILWAUKEE BREWERS	F08
	MINNESOTA TWINS	F09
	NEW YORK YANKEES	F10
	OAKLAND ATHLETICS	F11
	SEATTLE MARINERS	F12
	TEXAS RANGERS	F13
	TORONTO BLUE JAYS	F14
	ATLANTA BRAVES	F15
	CHICAGO CUBS	F16
	CINCINNATI REDS	F17
	HOUSTON ASTROS	F18
	LOS ANGELES DODGERS	F19
	NEW YORK METS	F21
	PHILADELPHIA PHILLIES	F22
	PITTSBURGH PIRATES	F23
	ST. LOUIS CARDINALS	F24
	SAN DIEGO PADRES	F25
	SAN FRANCISCO GIANTS	F26
	COLORADO ROCKIES	F27
	MIAMI MARLINS	F28
	ARIZONA DIAMONDBACKS	F29
	TAMPA BAY RAYS	F30
	WASHINGTON NATIONALS	F31

Major League Baseball trademarks and copyrights are used with permission of Major League Baseball Properties, Inc. Visit MLB.com

**TEAM JUMBO FOAM
BAT AND BALL SET** 

- 21" JUMBO RUBBER FOAM BAT WITH OFFICIAL TEAM LOGOS
- 4" PU FOAM BALL WITH TEAM LOGOS AND COLORS

ITEM 15120FXX (TEAM STYLE #F01-F31)
PACK 6



**TEAM
2.5" WRISTBANDS** 

- 2.5" WRISTBAND PAIT PACK WITH EMBOSSED TEAM LOGOS
- WASHABLE TERRY/ACRYLIC BLEND

ITEM 2735FXXP12 (TEAM STYLE #F01-F31)
PACK 12



NOTE: NOT ALL TEAMS SHOWN. SEE PAGE 76 FOR COMPLETE MLB TEAM LISTING