

First Alert

USER'S MANUAL

120V AC/DC POWERED 135°F FIXED AND 15°F/MINUTE RATE-OF-RISE HEAT ALARM WITH BATTERY BACK-UP

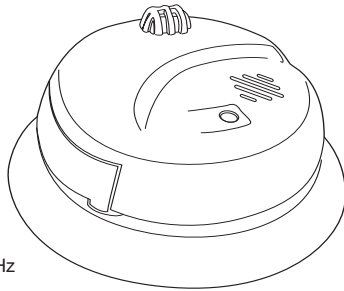

120V AC ~ 60 Hz
0.07Amps

IMPORTANT! PLEASE READ CAREFULLY AND SAVE.
This user's manual contains important information about your Heat Alarm's operation. If you are installing this Heat Alarm for use by others, you must leave this manual—or a copy of it—with the end user.

**LISTED TO
UL 539
STANDARD**

Model
HD6135FB

M08-0026-003 Q 08/08 Printed in Mexico

TABLE OF CONTENTS

Basic Features1
 Fire Safety Tips1
 Before You Install This Heat Alarm1
 How This Heat Alarm Works2
 How To Install This Heat Alarm2-3
 Locking Features4
 Weekly Testing5
 Regular Maintenance5
 If You Suspect a Problem5
 Understanding the Indicator Lights and Alarm Horn Patterns5
 If This Heat Alarm Sounds6
 What To Do In Case Of Fire6
 Using the Silence Features6
 Latching Alarm Indicator6
 Recommended Locations For Heat Alarms6-7
 Locations To Avoid For Heat Alarms7
 Special Compliance Considerations7
 Limitations of Heat Alarms8
 Limited Warranty8

© 2008 BRK Brands, Inc. All rights reserved. Distributed by BRK Brands, Inc. 3901 Liberty Street Road, Aurora, IL 60504-8122
Consumer Affairs: (800) 323-9005
www.brkelectronics.com • www.firstalert.com

INTRODUCTION

Thank you for choosing First Alert® for your Heat Alarm needs. You have purchased a state-of-the-art Heat Alarm designed to provide you with early warning of increased temperatures that may be the result a fire.

Key features include:

135° F Fixed and 15° F/Minute Rate of Rise—Programmed to alarm when temperature reaches 135°F or when the microprocessor senses a temperature rise of 15° F per minute. This allows the unit to sense a heat rise and alarm prior to reaching the fixed temperature of 135° F, providing a more rapid response to a potential fire.

Exclusive IR* Remote Control Feature—Lets you Test or Silence the Heat Alarm using most commonly available remote controls.

Latching Alarm Indicator—Microprocessor controlled feature automatically identifies and remembers which unit in an interconnected series initiated an alarm, even after the alarm condition has ended.

Two Silence Features:

1. Temporarily silences the low battery chirp for up to 8 hours without removing the battery.
2. Temporarily silences an unwanted nuisance alarm for up to 15 minutes.

Battery Compartment—swings out for quicker, easier battery installation even when unit is mounted.

Interconnectable—Can be interconnected with BRK Smoke Alarms.

* Infrared (IR) remote controls like those used for TV's and VCRs.

FIRE SAFETY TIPS

Follow safety rules and prevent hazardous situations: 1) Use smoking materials properly. Never smoke in bed. 2) Keep matches or lighters away from children; 3) Store flammable materials in proper containers; 4) Keep electrical appliances in good condition and don't overload electrical circuits; 5) Keep stoves, barbecue grills, fireplaces and chimneys grease- and debris-free; 6) Never leave anything cooking on the stove unattended; 7) Keep portable heaters and open flames, like candles, away from flammable materials; 8) Don't let rubbish accumulate.

Keep alarms clean, and test them weekly. Replace alarms immediately if they are not working properly. Heat and Smoke Alarms that do not work cannot alert you to a fire. Keep at least one working fire extinguisher on every floor, and an additional one in the kitchen. Have fire escape ladders or other reliable means of escape from an upper floor in case stairs are blocked.

BEFORE YOU INSTALL THIS HEAT ALARM

IMPORTANT! Read "Recommended Locations for Heat Alarms" and "Locations to Avoid for Heat Alarms" before beginning. This unit monitors the air, and when heat reaches its sensing chamber, it alarms. It can give you more time to escape before fire spreads. This unit can ONLY give an early warning of developing fires if it is installed, maintained and located where heat can reach it, and where all residents can hear it, as described in this manual. This unit will not sense gas, smoke, or flame. It cannot prevent or extinguish fires.

Know Where To Install Your Heat Alarms

See "Recommended Locations For Heat Alarms" and "Locations To Avoid For Heat Alarms" for details.

Know What Heat Alarms Can and Can't Do

A Heat Alarm can help alert you to fire, giving you precious time to escape. It can only sound an alarm once heat reaches the sensor. See "Limitations of Heat Alarms" for details.

Check Your Local Building Codes

This Heat Alarm is designed to be used in a typical single-family home. It alone will not meet requirements for boarding houses, apartment buildings, hotels or motels. See "Special Compliance Considerations" for details.

⚠WARNING!

- This device is not intended to alert hearing impaired residents. Smoke Alarms specifically designed for the hearing impaired, which feature devices like flashing strobe lights, are available to alert the hearing impaired in case of fire.
- Installation of this Heat Alarm must conform to the electrical codes in your area; Articles 210 and 300.3 (B) of the National Electrical Code (NFPA 70), NFPA 72, NFPA 101; SBC (SBCCI); NBC (BOCA); OTFDC (CABO), and any other local or building codes that may apply. Wiring and installation must be performed by a licensed electrician. Failure to follow these guidelines may result in injury or property damage.
- This Heat Alarm is not a Smoke Alarm. This unit is not suitable protection when used alone. Do not use this unit as the only means of fire detection in a home. This unit is intended for use as a supplement to Smoke Alarms.
- This Heat Alarm must have AC or battery power to operate. If the AC power fails, battery back-up will allow the alarm to operate for a limited time. If AC power fails and the battery is dead or missing, the alarm cannot operate.
- This unit must be powered by a 24-hour, 120VAC 60Hz circuit. Be sure the circuit cannot be turned off by a switch, dimmer, or ground fault circuit interrupter. Failure to connect this unit to a 24-hour circuit and keeping fresh batteries installed, may prevent it from providing constant protection.
- Never disconnect the power from an AC powered unit to stop an unwanted alarm. Doing so will disable the unit and remove your protection. In the case of a true unwanted alarm, use the Silence Feature by using an IR remote control or by pressing the Test/Silence button or fan the heat away from the unit. The alarm will reset automatically when it returns to normal operation.
- NEVER ignore any alarm. Read "If Your Heat Alarm Sounds" for more information on how to respond to an alarm. Failure to respond can result in injury or death.
- Test this Heat Alarm once a week. If it ever fails to test correctly, have it replaced immediately! If the Alarm is not working properly, it cannot alert you to a problem.

⚠CAUTION!

- Connect this Heat Alarm ONLY to other compatible units. See "Special Requirements for Interconnected Heat Alarms" for details. Do not connect it to any other type of alarm or auxiliary device. Connecting anything else to this unit may damage it or prevent it from operating properly.
- DO NOT stand too close to the unit when the alarm is sounding. It is loud to alert you in an emergency. Exposure to the horn at close range may harm your hearing. When testing the unit, step back when the horn starts sounding.
- Do not paint over the Heat Alarm. Paint may clog the openings to the sensor and prevent the Heat Alarm from operating properly.

HOW THIS HEAT ALARM WORKS

Fixed Temperature and Rate-of-Rise.

This Heat Alarm monitors the air and when heat reaches the sensor, it alarms. The unit will alarm either when the temperature reaches a fixed 135° F (57° C) or the microprocessor detects a 15° F (8.3° C) per minute rate of rise temperature change. This allows the unit to sense a heat rise and alarm prior to reaching the fixed temperature of 135° F (57° C), providing quicker response to a potential fire.

Heat Alarms are intended for use as supplemental safety devices with Smoke Alarms. Heat Alarms are designed for use in areas where Smoke Alarms cannot be installed due to temperature and environmental conditions, as in unheated garages and crawl spaces. A Heat Alarm can only give early warning of a developing fire if it is properly installed and maintained and located where heat can reach it. The unit will not sense gas, smoke or flame. Heat Alarms cannot prevent or extinguish fires.

IMPORTANT!

This Heat Alarm is approved for use in single-family residences. It is NOT designed for marine or RV use.

THE COVER OF YOUR HEAT ALARM

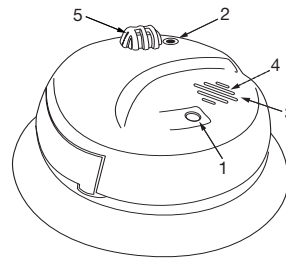

1. Power Light, Test/Silence Button
2. Remote Control "Eye": Aim an infrared remote control at the "Eye" on the Alarm to test or silence the unit. (Works with most infrared remote controls.)
3. Air Vents
4. (Behind the Cover) Alarm Horn: 85 dB audible alarm for test, alarm, and unit malfunction warning.
5. Heat Sensor

HOW TO INSTALL THIS HEAT ALARM

This Heat Alarm is designed to be mounted on any standard wiring junction box to a 4-inch (10 cm) size, on either the ceiling or wall (if allowed by local codes). Read "Recommended Locations For Heat Alarms" and "Locations to Avoid For Heat Alarms" before you begin installation.

Tools you will need: • Needle-nose pliers or utility knife • Standard Flathead screwdriver.

⚠ WARNING!

Make sure the Alarm is not receiving excessive noisy power. Examples of noisy power could be major appliances on the same circuit, power from a generator or solar power, light dimmer on the same circuit or mounted near fluorescent lighting. Excessive noisy power may cause damage to your Alarm.

THE PARTS OF THIS HEAT ALARM

The Mounting Bracket:

To remove the mounting bracket from the Heat Alarm base, hold the Heat Alarm base firmly and twist the mounting bracket counterclockwise. The mounting bracket installs onto the junction box. It has a variety of screw slots to fit most boxes.

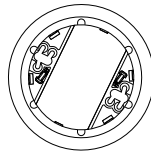

The Power Connector:

The power connector plugs into a power input block on the Heat Alarm. It supplies the unit with AC power.

- The black wire is "hot."
- The white wire is neutral.
- The orange wire is used for interconnect.

If you need to remove the power connector, disconnect AC power at the electrical panel; insert a flat screwdriver blade between the power connector and the security tab inside the power input block. Gently pry back the tab and pull the connector free.

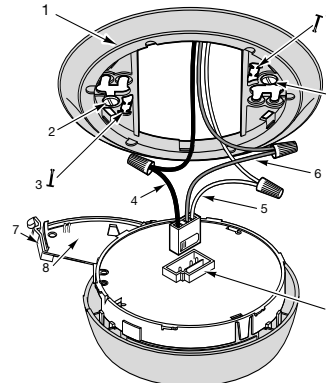

The Parts of This Unit

- 1 Mounting Bracket
- 2 Mounting Slots and Screws
- 3 Locking Pins (break out of bracket)
- 4 Hot (Black) AC Wire
- 5 Neutral (White) AC Wire
- 6 Interconnect (Orange) Wire
- 7 Latch to Open Battery Compartment
- 8 Swing-Out Battery Compartment
- 9 Quick-Connect Power Connector

FOLLOW THESE INSTALLATION STEPS

The basic installation of this Heat Alarm is the similar whether you want to install one Heat Alarm, or interconnect more than one Heat Alarm. If you are interconnecting more than one Heat Alarm, you **MUST** read "Special Requirements for Interconnected Heat Alarms" below before you begin installation.

⚠ DANGER!

ELECTRICAL SHOCK HAZARD. Turn off power to the area where you will install this unit at the circuit breaker or fuse box before beginning installation. Failure to turn off the power before installation may result in serious electrical shock, injury or death.

1. Remove the mounting bracket from the base. Position the screw slots on the mounting bracket over the screws in the junction box. Tighten the screws.
2. Using wire nuts, connect the power connector to the household wiring.

⚠ WARNING!

Improper wiring of the power connector or the wiring leading to the power connector will cause damage to the Alarm and may lead to a non-functioning Alarm.

STAND-ALONE ALARM ONLY:

- Connect the white wire on the power connector to the neutral wire in the junction box.
- Connect the black wire on the power connector to the hot wire in the junction box.
- Tuck the orange wire inside the junction box. It is used for interconnect only.

INTERCONNECTED UNITS ONLY:

Strip off about 1/2" (12 mm) of the plastic coating on the orange wire on the power connector.

- Connect the white wire on the power connector to the neutral wire in the junction box.
- Connect the black wire on the power connector to the hot wire in the junction box.
- Connect the orange wire on the power connector to the interconnect wire in the junction box. Repeat for each unit you are interconnecting. Never connect the hot or neutral wires in the junction box to the orange interconnect wire. Damage may result.
- Never cross-connect hot and neutral wires between interconnected Alarms. Damage will result.

3. Plug the power connector into the back of the Heat Alarm.
4. Position the base of the Alarm over the mounting bracket and turn. The Alarm can be positioned over the bracket every 60°. Turn the Alarm clockwise (right) until the unit is in place.
5. Check all connections.

STAND-ALONE ALARM ONLY:

- If you are only installing one Heat Alarm, restore power to the junction box.

INTERCONNECTED UNITS ONLY:

- If you are interconnecting multiple Heat Alarms, repeat steps 1-5 for each Heat Alarm in the series. When you are finished, restore power to the junction box.

⚠ DANGER!

ELECTRICAL SHOCK HAZARD. Do not restore power until all Heat Alarms are completely installed. Restoring power before installation is complete may result in serious electrical shock, injury or death.

6. Make sure the Heat Alarm is receiving AC power. Under normal operation, the green light (LED) will shine continuously.

7. If the green power indicator light does not light, **TURN OFF POWER TO THE JUNCTION BOX** and recheck all connections. If all connections are correct and the power indicator still does not light when you restore the power, the unit should be replaced immediately.

8. Test each Heat Alarm. Press the Test/Silence button until you hear a brief acknowledge (or feedback) chirp. The alarm will sound: 3 beeps, pause, 3 beeps, pause.

When testing a series of interconnected units you must test each unit individually. Make sure all units alarm when each one is tested.

⚠ DANGER!

If any unit in the series does not alarm, **TURN OFF POWER** and recheck connections. If it does not alarm during testing when you restore power, replace it immediately.

SPECIAL REQUIREMENTS FOR INTERCONNECTED HEAT ALARMS

⚠ WARNING!

- Failure to meet any of these requirements could damage the units and cause them to malfunction, removing your protection.

Interconnected units can provide earlier warning of fire than stand-alone units, especially if a fire starts in a remote area of the dwelling. If any unit in the series senses heat, all units will alarm.

IMPORTANT!

Interconnect units within a single family residence only. Otherwise all households will experience unwanted alarms when you test any unit in the series. Interconnected units will only work if they are wired to compatible units and all requirements are met. This unit is designed to be compatible with: **First Alert**® Smoke Alarm Models SA4120, SA4121B, SA4919B, SA100B and **BRK Electronics**® Smoke Alarm Models 100S, 2002RAC, 4120, 4120B, 4120SB, 4919, 5919, 5919TH; **BRK Electronics**® Smoke/CO Alarm Model SC6120B.

Interconnected units must meet ALL of the following requirements:

- A maximum of 18 compatible Smoke, Heat or CO Alarms may be interconnected. To comply with NFPA limits, no more than 12 of the 18 alarms may be Smoke Alarms.
- The same fuse or circuit breaker must power all interconnected units.
- All wiring must conform to all local electrical codes and NFPA 70 (NEC). Refer to NFPA, Chapter 2 and/or your local building code for further connection requirements.

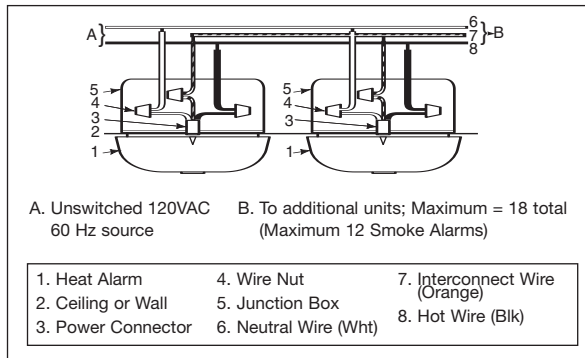

LOCKING FEATURES

The locking features are designed to discourage unauthorized removal of the battery or alarm. It is not necessary to activate the locks in single-family households where unauthorized battery or alarm removal is not a concern.

These Heat Alarms have two separate locking features: one to lock the battery compartment, and the other to lock the Heat Alarm to the mounting bracket. You can choose to use either feature independently, or use them both.

Tools you will need: • Needle-nose pliers or utility knife • Standard Flathead screwdriver.

Both locking features use locking pins, which are molded into the mounting bracket. Using needle nose pliers or a utility knife, remove one or both pins from the mounting bracket, depending on how many locking features you want to use.

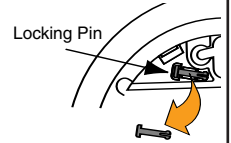

IMPORTANT!

To permanently remove either lock insert a flathead screwdriver between the locking pin and the lock, and pry the pin out of the lock.

TO LOCK THE BATTERY COMPARTMENT

Do not lock the battery compartment until you have activated the battery and tested the battery back-up.

1. Activate the battery back-up by removing the "Pull to Activate Battery Back-Up" tab.

DO NOT remove the battery activation until AC power is turned on to conserve battery power.

2. Press the Test/Silence button until you hear a brief acknowledge (or feedback) chirp. The alarm will sound: 3 beeps, pause, 3 beeps, pause.

IMPORTANT!

If the unit does not alarm during testing, **DO NOT** lock the battery compartment! Install a new battery and test again. If the Heat Alarm still does not alarm, replace it immediately.

3. Using needle-nose pliers or a utility knife, detach one locking pin from the mounting bracket.

4. Push the locking pin through the black dot on the label on the back of the Heat Alarm.

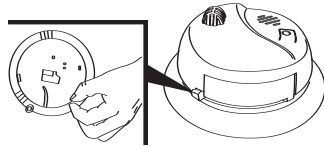
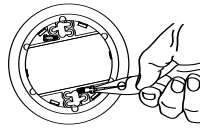
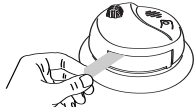

TO UNLOCK THE BATTERY COMPARTMENT

IMPORTANT!

Once the Heat Alarm is installed, you must disconnect it from the AC power before unlocking the battery compartment.

⚠ DANGER!

ELECTRICAL SHOCK HAZARD. Turn off the power to the area where the Heat Alarm is installed before removing it from the mounting bracket. Failure to turn off the power first may result in serious electrical shock, injury or death.

⚠ WARNING!

Turn off the AC power at the circuit breaker or fuse box.

1. Remove the Heat Alarm from the mounting bracket. If the unit is locked to the bracket, see the section "To Unlock the Mounting Bracket."
2. Disconnect the power connector by gently prying it away from the back of the Heat Alarm.
3. Insert a flathead screwdriver under the head of the locking pin, and gently pry it out of the battery compartment lock. (If you plan to relock the battery compartment, save the locking pin.)
4. To relock the battery compartment, close the battery door and reinsert locking pin in lock.
5. Reconnect the power connector to the back of the Alarm, reattach the Heat Alarm to the mounting bracket, and restore the power.

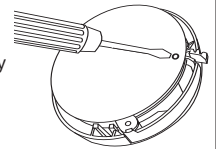

IMPORTANT!

When replacing the battery, always test the Heat Alarm before relocking the battery compartment.

TO LOCK THE MOUNTING BRACKET

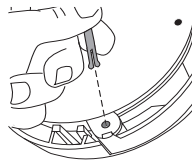
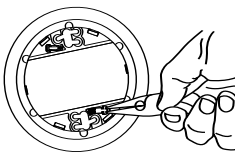

1. Using needle-nose pliers, detach one locking pin from mounting bracket.
2. Insert the locking pin into the lock located on the pivoting hinge of the battery door.
3. When you attach the Alarm to the mounting bracket, the locking pin's head will fit into a notch on the bracket.

TO UNLOCK THE MOUNTING BRACKET

⚠ DANGER!

ELECTRICAL SHOCK HAZARD. Turn off the power to the area where the Heat Alarm is installed before removing it from the mounting bracket. Failure to turn off the power first may result in serious electrical shock, injury or death.

⚠ WARNING!

Always discharge the branch circuit before servicing an AC or AC/DC Heat Alarm. First, turn off the AC power at the circuit breaker or fuse box. Next, remove the battery from Alarms with battery back-up. Finally, press the test button to discharge the branch circuit.

1. Insert a flathead screwdriver between the mounting bracket pin and the mounting bracket.

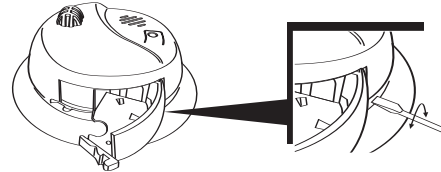

2. Pry the Heat Alarm away from the bracket by turning both the screwdriver and the Heat Alarm counterclockwise (left) at the same time.

WEEKLY TESTING

⚠ WARNING!

- **NEVER use an open flame of any kind to test this unit. You might accidentally damage or set fire to the unit or to your home. The built-in test switch accurately tests the unit's operation as required by Underwriters Laboratories, Inc. (UL).**
- **If the Alarm ever fails to test properly, replace it immediately. Products under warranty may be returned to the manufacturer for replacement. See "Limited Warranty" at the end of this manual.**
- **DO NOT stand close to the Alarm when the horn is sounding. Exposure at close range may be harmful to your hearing. When testing, step away when horn starts sounding.**

It is important to test this unit every week to make sure it is working properly. Press and hold the test button until the alarm sends a test command acknowledge "chirp" just before it sounds continuously (the unit will continue to alarm for a few seconds after you release the button). If it does not alarm, make sure it is receiving power and has a fresh battery, and test it again. If it still does not alarm, it should be replaced immediately.

When testing one unit, all interconnected alarms will sound. If they don't, check the connection with power to the units turned off, restore power and try again. Test all units in a series, not just one. Using the test button is the ONLY correct way to test the Heat Alarm.

USING THE REMOTE CONTROL WEEKLY TEST/SILENCE FEATURE

Using the VOLUME or CHANNEL buttons on most remote controls, you can test or silence this Alarm from up to 12 feet (3.7 meters) away.

To Test (or Silence) the Alarm:

1. Make sure you have a clear path between you and the alarm, free of any obstructions.
2. Point the remote at the front of the Alarm.
3. Press the VOLUME or CHANNEL button for at least 2 seconds. You will hear a brief acknowledge "chirp" when the Alarm receives the test (or silence) command.

If the Alarm does not respond to your remote control:

- You may be standing too far away.
- Your remote may not be compatible.
- You did not hold the button on your remote for at least 2 seconds.

REGULAR MAINTENANCE

This unit has been designed to be as maintenance-free as possible, but there are a few simple things you must do to keep it working properly.

⚠ WARNING!

Use only the replacement batteries listed below. The unit may not operate properly with other batteries. Never use rechargeable batteries since they may not provide a constant charge.

- Test it at least once a week.
- Clean the Heat Alarm at least once a month; gently vacuum the outside of the Heat Alarm using your household vacuum's soft brush attachment. Test the Heat Alarm. Never use water, cleaners or solvents since they may damage the unit.
- If the Heat Alarm becomes contaminated by excessive dirt, dust and/or grime, and cannot be cleaned to avoid unwanted alarms, replace the unit immediately.
- Relocate the unit if it sounds frequent unwanted alarms. See "Locations to Avoid for Heat Alarms" for details.
- When the battery becomes weak, the Heat Alarm unit will "chirp" about once a minute (the low battery warning). You should replace the battery immediately to continue your protection.

Choosing a replacement battery:

Your Heat Alarm's battery back-up requires one standard 9V battery. The following batteries are acceptable as replacements. This list supplements the list on the Heat Alarm battery door: Eveready #522 (Energizer); Duracell #MN1604, MX1604 (Ultra). You may also use a Lithium battery like the Ultralife U9VL-J for longer service life between battery changes. These batteries are available at many local retail stores.

IMPORTANT!

Actual service life depends on the Heat Alarm and the environment in which it is installed. Constant exposures to high or low temperatures or high humidity may reduce battery life. All the batteries specified above are acceptable replacement batteries for this unit. Use of a different battery may have a detrimental effect on Alarm operation. Regardless of the manufacturer's suggested battery life, you MUST replace the battery immediately once the unit starts "chirping" (the "low battery warning").

IF YOU SUSPECT A PROBLEM

Heat Alarms may not operate properly because of dead, missing or weak batteries, a build-up of dirt, dust or grease on the Heat Alarm cover, or installation in an improper location. Clean the Heat Alarm as described in "Regular Maintenance," and install a fresh battery, then test the Heat Alarm again. If it fails to test properly when you use the test button, or if the problem persists, replace the Heat Alarm immediately.

- **If you hear a "chirp" once a minute, replace the battery.**
- **If you experience frequent non-emergency alarms try relocating the Heat Alarm.**
- **If the alarm sounds when no smoke is visible, try cleaning or relocating the Heat Alarm. The cover may be dirty.**
- **If the alarm does not sound during testing, make sure it is receiving AC power from the household current.**

⚠ WARNING!

Always discharge the branch circuit before servicing an AC or AC/DC Heat Alarm. First, turn off the AC power at the circuit breaker or fuse box. Next, remove the battery from Heat Alarms with battery back-up. Finally, press the test button to discharge the branch circuit.

Do not try fixing the alarm yourself – this will void your warranty!

If the Heat Alarm is still not operating properly, and it is still under warranty, please see "How to Obtain Warranty Service" in the Limited Warranty.

UNDERSTANDING THE INDICATOR LIGHTS AND ALARM HORN PATTERNS

Condition	LED	Horn
AC POWER ON (Normal operation)	LED shines GREEN continuously	Silent; no audible alarm
DC POWER (Battery back-up active)	LED flashes GREEN once per minute while battery powers unit	One horn "chirp" to signal loss of AC power
RESUME AC POWER	GREEN LED turns ON	Horn "chirps" one time to signal resumption of AC power
DURING TESTING (Under AC or DC power)	LED flashes RED, the same pattern as the horn	Audible alarm: 3 beeps, pause, repeating horn pattern
ALARM CONDITION* (Initiating Unit)	LED flashes RED, the same pattern as the horn	Audible alarm: 3 beeps, pause, repeating horn pattern
LATCHING ALARM ACTIVE** (Under AC or DC Power)	LED flashes RED once every 5 seconds	Silent; no audible alarm
ALARM SILENCE	LED flashes RED once every 5 seconds	No signal
LOW BATTERY	GREEN LED flashes once every minute	Horn "chirps" once per minute, in sync with LED. NOTE: If the battery is VERY LOW, the horn may either chirp once per second, or sound continuously
MALFUNCTION (Unit MUST be replaced)	LED flashes RED rapidly three times, in sync with three horn "chirps", once every minute	Horn "chirps" three times, in sync with three LED flashes

*When any Heat Alarm in an interconnected series triggers an alarm, its red LED will flash rapidly. The red LEDs will not flash on any remaining alarms in the series. This feature helps responders identify which unit(s) triggered the alarm.

**The Latching Alarm indicator is activated after an Alarm is exposed to alarm levels of heat. After heat levels drop below alarm levels, the LED begins to flash RED once every 5 seconds. See "The Latching Alarm Indicator" for details.

IF THIS HEAT ALARM SOUNDS

RESPONDING TO AN ALARM

During an alarm, you will hear a loud, repeating horn pattern: 3 beeps, pause, 3 beeps, pause.

⚠ WARNING!

- If the unit alarms and you are not testing the unit, it is warning you of a potentially dangerous situation that requires your immediate attention. NEVER ignore any alarm. Ignoring the alarm may result in injury or death.
- Never disconnect the AC power or remove the battery back-up to quiet an unwanted alarm. Disconnecting the power disables the alarm so it cannot sense heat. This will remove your protection.
- If the unit alarms and you are not absolutely certain of the source of the heat, get everyone out of the house immediately.

⚠ DANGER!

- **ELECTRICAL SHOCK HAZARD:** Attempting to disconnect the power connector from the unit when the power is on may result in electrical shock, serious injury or death.

When an interconnected system of units is in alarm, the Red LED on the unit(s) that initiated the alarm will flash in sync with the horn. The LED will not flash on any remaining units.

WHAT TO DO IN CASE OF FIRE

- Don't panic; stay calm. Follow your family escape plan.
- Get out of the house as quickly as possible. Don't stop to get dressed or collect anything.
- Feel doors with the back of your hand before opening them. If a door is cool, open it slowly. Don't open a hot door. Keep doors and windows closed, unless you must escape through them.
- Cover your nose and mouth with a cloth (preferably damp). Take short, shallow breaths.
- Meet at your planned meeting place outside your home, and do a head count to make sure everybody got out safely.
- Call the Fire Department as soon as possible from outside. Give your address, then your name.
- Never go back inside a burning building for any reason.
- Contact your Fire Department for ideas on making your home safer.

USING THE SILENCE FEATURES

If you are absolutely certain the alarm is caused by a non-emergency, non-fire situation, you may use the Silence Feature to silence the Alarm. The Silence Feature on this unit can temporarily quiet an unwanted alarm for up to 15 minutes.

⚠ WARNING!

The Silence Feature is for your convenience only and will not correct a problem.

IMPORTANT!

The Silence Feature is intended to temporarily silence the Alarm horn. It will not extinguish a fire.

To temporarily silence the alarm:

1. **Option 1:** Press the Test/Silence button on the cover of the Heat Alarm that initiated the alarm.*
2. **Option 2:** Point a universal IR remote control at the Heat Alarm that initiated the alarm* and press the channel or volume button until the alarm is silent. (See "Using the Remote Control Weekly Test/Silence Feature" for details). An acknowledge tone will be issued by the Alarm to let you know that the silence command has been received.

*To silence Heat Alarms in an interconnected series:

To silence multiple Alarms in an interconnected series, you must press the Test/Silence button on the unit(s) that triggered the alarm. Pressing the Test/Silence button on a unit that did not trigger the alarm will only silence that Alarm.

NOTE: The red light under the Silence button on the initiating alarm will flash in sync with the horn. The red light will be off on all other Heat Alarms.

IMPORTANT!

If any unit will not silence and no heat is present install a new battery and re-test it. If it still will not silence, the unit should be replaced immediately.

LOW BATTERY SILENCE FEATURE

If AC power is on, briefly press the Test/Silence button or use a Remote Control to silence the low battery "chirp" for up to 8 hours. A brief "chirp" will let you know that the Alarm has accepted the Low Battery Silence command. The Alarm will continue to operate as long as AC power is supplied. However, replace the battery as soon as possible, to maintain protection in event of a power outage.

"LATCHING ALARM" INDICATOR

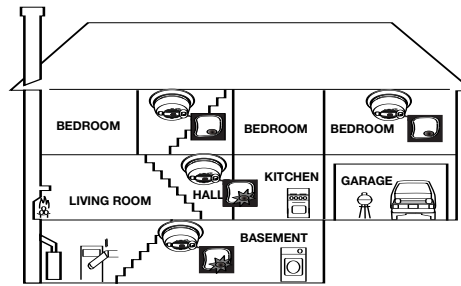

KEY:

- LATCHING ALARM:** Unit was exposed to alarm levels of Smoke or Heat
- LATCHING NOT ACTIVATED:** Unit was not exposed to alarm levels of Smoke or Heat

The Latching Alarm Indicator is activated after an Alarm is exposed to alarm levels of heat. After heat levels drop below alarm levels, the red LED will begin to flash once every 5 seconds. It will continue to flash or "latch" until you clear it using the Test/Silence button. Press and hold the Test/Silence button until the horn sounds.

This feature helps emergency responders, investigators, or service technicians identify which unit(s) in your home were exposed to alarm levels of heat. This can help investigators pinpoint the initiating alarm.

RECOMMENDED LOCATIONS FOR HEAT ALARMS

In Single-Family Residences.

For minimum coverage, BRK Brands, Inc. recommends you install Heat Alarms in any area not suitable for smoke alarms such as garages, kitchens, utility/laundry rooms, furnace rooms and crawl spaces. Install where temperatures normally remain between -10° F and 100° F (-23° C and 38° C). For National Fire Protection Association (NFPA) information, see "Agency Placement Recommendations for Heat Alarms and Smoke Alarms."

RECOMMENDED PLACEMENT

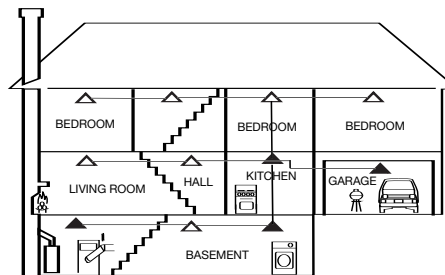

- ▲ INTERCONNECTED HEAT ALARMS IN GARAGES, KITCHENS, UTILITY/LAUNDRY ROOMS, FURNACE ROOMS AND CRAWL SPACES AND ONLY AS A SUPPLEMENT TO SMOKE ALARMS.
- ▲ FOR MAXIMUM PROTECTION USE INTERCONNECTED SMOKE ALARMS WITH BATTERY BACK-UP AS SHOWN.

Heat Alarms Recommended in New Home Construction

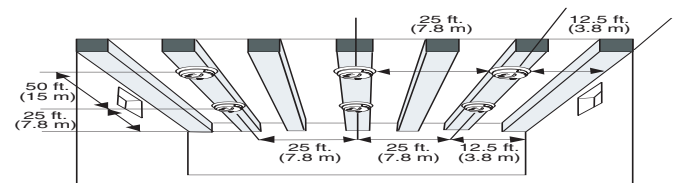

Heat Alarms should be mounted on the bottom of the joists and not up in the joist channels.

- The recommended location for a Heat Alarm is at the center of the ceiling. At this location, the Heat Alarm is closest to all areas of the room.
- If it is not practical to install the Heat Alarm in the center of the room, use an off-center location not less than 4 inches (102 mm) from the sidewall.
- If it is not practical to install the Heat Alarm on the ceiling, the next logical location is on a sidewall. A Heat Alarm mounted on a sidewall should have the top of the unit between 4 and 12 inches (102 mm and 305 mm) from the ceiling.
- The smooth ceiling distance between Heat Alarms shall not exceed spacings as determined by UL fire tests. This Heat Alarm has a 50 foot (15 meter) spacing.
- Reduced spacing may be required due to factors such as exposed joists, drafts, ceiling heights greater than 10 feet (3 meters), and other structural characteristics that may affect Heat Alarm operation. Walls, partitions, doorways, and joists interrupt the normal flow of heat creating new areas to be protected.

Continued...

RECOMMENDED PLACEMENT, Continued

NFPA Standard 72 Appendix A-2-5.2.2.2 part c-d

(c) The Spacing of Detectors: Where a room is too large for protection by a single detector, several detectors should be used. It is important that they be properly located so all parts of the room are covered.
(d) Where the Distance Between Detectors Should Be Further Reduced: The distance between detectors is based on data obtained from the spread of heat across a smooth ceiling. Where the ceiling is not smooth, the placement of the detector should be tailored to the situation.

For instance, with open wood joists, heat travels freely down the joist channels so that the maximum distance between detectors [50 ft (15 m)] may be permitted to be used. However, heat has trouble spreading across the joists, so the distance in this direction should be 1/2 the distance allowed between detectors, as shown in the illustration above ("Heat Alarms Recommended in New Home Construction") and the distance to the wall is reduced to 12-1/2 ft. (3.8 m). Since 1/2 x 50 ft. (15 m) is 25 ft. (7.6 m), the distance between detectors across open wood joists should not exceed 25 ft. (7.6 m), as shown in "Heat Alarms Recommended in New Home Construction," and the distance to the wall is reduced [1/2 x 25 ft. (7.6 m)] to 12.5 ft. (3.8 m). Paragraph 2-5.2.2.4 requires that detectors be mounted on the bottom of the joists and not up in joist channels.

Walls, partitions, doorways, ceiling beams, and open joists interrupt the normal flow of heat, thus creating new areas to be protected.

AGENCY PLACEMENT RECOMMENDATIONS FOR HEAT AND SMOKE ALARMS

NFPA Appendix A-2-5.2.2: While Chapter 2 does not require heat detectors as part of the basic protection scheme, it is recommended that the homeowner consider the use of additional heat detectors...The additional areas lending themselves to protection with heat detectors are: kitchen, dining room, attic (finished or unfinished), furnace room, utility room, basement and integral or attached garages. For bedrooms, the installation of a smoke detector is preferable to the installation of a heat detector.

The following recommendations reference location and usage of Smoke Alarms. Heat Alarms are intended as supplemental safety devices. Do not rely solely on Heat Alarms to alert you to fire.

NFPA 72 (National Fire Code)

Smoke Alarms shall be installed in each separate sleeping room, outside each sleeping area in the immediate vicinity of the bedrooms and on each additional story of the family living unit, including basements and excluding crawl spaces and unfinished attics.

In new construction, Alarms shall be so arranged that operation of any one Alarm shall cause the operation of all Alarms within the dwelling.

Smoke Detection-Are More Smoke Alarms Desirable? The required number of Smoke Alarms might not provide reliable early warning protection for those areas separated by a door from the areas protected by the required Smoke Alarms. For this reason, it is recommended that the homeowner consider the use of additional Smoke Alarms for those areas for increased protection. The additional areas include the basement, bedrooms, dining room, furnace room, utility room, and hallways not protected by the required Smoke Alarms. The installation of Smoke Alarms in kitchens, attics (finished or unfinished), or garages is not normally recommended, as these locations occasionally experience conditions that can result in improper operation.

California State Fire Marshal (CSFM)

Early warning detection is best achieved by the installation of fire detection equipment in all rooms and areas of the household as follows: A Smoke Alarm installed in each separate sleeping area (in the vicinity, but outside bedrooms), and Heat or Smoke Alarms in the living rooms, dining rooms, bedrooms, kitchens, hallways, finished attics, furnace rooms, closets, utility and storage rooms, basements, and attached garages.

Additional local building and regulatory codes may apply in your area. Always check compliance requirements before beginning any installation.

IMPORTANT!

Specific requirements for Heat or Smoke Alarm installation vary from state to state and from region to region. Check with your local Fire Department for current requirements in your area. If you install AC or AC/DC units, it is recommended they be interconnected for added protection. Interconnect Smoke and Heat Alarms for added protection.

LOCATIONS TO AVOID FOR HEAT ALARMS

This unit works best when it's clean and nothing interferes with the sensor. If exposed to dirt, grease, extreme temperatures not caused by fire (especially in attics where daily temperatures can exceed the 135° F (57° C) alarm level or high humidity, it may sound "unwanted" alarms. If Heat Alarms are installed where heat can't reach them—like in "dead air spaces" or near fans—they may not be able to provide an early enough warning in case of fire.

For best performance, do not install the Heat Alarm:



In a location where it could be easily triggered when using your remote to operate your TV, VCR, or other remote controlled appliances.

- Where temperatures are regularly below -20° F (-29° C) or above 115° F (46° C), including unheated buildings, outdoor rooms, or porches.
- Do not install a Heat Alarm directly over the stove or range. Clean a laundry room unit frequently to keep it free of dirt or lint.
- Near fresh air vents, ceiling fans, or in very drafty areas. Drafts can blow heat away from the unit, preventing it from reaching the sensing chamber.
- In "dead air" spaces. Install units according to "Avoiding Dead Air Spaces".
- Less than 12 inches (305 mm) away from fluorescent lights. Electrical "noise" can interfere with the sensor.

AVOIDING DEAD AIR SPACES

"Dead air" spaces may prevent heat from reaching the Heat Alarm. To avoid dead air spaces, follow installation instructions in the "Recommended Locations for Heat Alarms" (refer to NFPA72 for details).

For wall mounting (if allowed by building codes), the top edge of Heat Alarms should be placed between 4 inches (102 mm) and 12 inches (305 mm) from the wall/ceiling line, below typical "dead air" spaces.

SPECIAL COMPLIANCE CONSIDERATIONS

The following recommendations reference location and usage of Smoke Alarms. Heat Alarms are only intended as supplemental safety devices. Do not rely solely on Heat Alarms to alert you to fire.

⚠WARNING!

This unit alone is not a suitable substitute for complete fire detection systems in places housing many people—like apartment buildings, condominiums, hotels, motels, dormitories, hospitals, long-term health care facilities, nursing homes, day care facilities, or group homes of any kind—even if they were once single-family homes. It is not a suitable substitute for complete fire detection systems in warehouses, industrial facilities, commercial buildings, and special-purpose non-residential buildings which require special fire detection and alarm systems. Depending on the building codes in your area, this unit may be used to provide additional protection in these facilities.

For your reference: The following is information on Smoke Alarm usage in various residences and institutions.

The following information applies to all five types of buildings listed below:

In new construction, most building codes require the use of AC or AC/DC powered Smoke Alarms only. AC, AC/DC, or DC powered Smoke Alarms can be used in existing construction as specified by local building codes. Refer to NFPA 72 (National Fire Alarm Code) and NFPA 101 (Life Safety Code), local building codes, or consult your Fire Department for detailed fire protection requirements in buildings not defined as "households."

1. Single-Family Residence:

Single family home, townhouse. It is recommended Smoke Alarms be installed on every level of the home, in every bedroom, and in each bedroom hallway.

2. Multi-Family or Mixed Occupant Residence:

Apartment building, condominium. This Smoke Alarm is suitable for use in individual apartments or condos, provided a primary fire detection system already exists to meet fire detection requirements in common areas like lobbies, hallways, or porches. Using this Smoke Alarm in common areas may not provide sufficient warning to all residents or meet local fire protection ordinances/regulations.

3. Institutions:

Hospitals, day care facilities, long-term health care facilities. This Smoke Alarm is suitable for use in individual patient sleeping/resident rooms, provided a primary fire detection system already exists to meet fire detection requirements in common areas like lobbies, hallways, or porches. Using this Smoke Alarm in common areas may not provide sufficient warning to all residents or meet local fire protection ordinances/regulations.

4. Hotels and Motels:

Also boarding houses and dormitories. This Smoke Alarm is suitable for use inside individual sleeping/resident rooms, provided a primary fire detection system already exists to meet fire detection requirements in common areas like lobbies, hallways, or porches. Using this Smoke Alarm in common areas may not provide sufficient warning to all residents or meet local fire protection ordinances/regulations.

5. Warehouses/Commercial Buildings:

DO NOT use this Alarm in warehouses, industrial or commercial buildings, special-purpose non-residential buildings, RVs, boats, or airplanes. This Alarm is specifically designed for residential use, and may not provide adequate protection in non-residential applications.

LIMITATIONS OF HEAT ALARMS

⚠WARNING!

This Heat Alarm is not a Smoke Alarm. This unit is not suitable protection when used alone. Do not use this unit as the only means of fire detection in a home. This unit is intended for use as a supplement to Smoke Alarms.

⚠CAUTION!

Heat Alarms are not life safety devices.

Heat Alarms are intended for use as supplements to Smoke Alarms.

Because this unit cannot detect smoke, carbon monoxide or other toxic gases, do not rely solely on this Heat Alarm in a fire emergency. Slow developing fires may produce smoke and toxic gasses without a significant increase in room temperatures. For this reason, Heat Alarms are only to be installed as supplementary protection with Smoke Alarms.

Heat Alarms cannot work without power. AC powered Heat Alarms and Smoke Alarms cannot work if the AC power is cut off for any reason (open fuse or circuit breaker, failure along a power line or at a power station, electrical fire that burns the electrical wires, etc.).

AC units with battery (DC) back-up: will operate if electricity fails, provided the batteries are fresh and correctly installed. AC and AC/DC units must be installed by a qualified electrician.

Heat Alarms for Solar or Wind Energy users and battery backup power systems: AC powered Heat Alarms should only be operated with true or pure sine wave inverters. Operating this Heat Alarm with most battery-powered UPS (uninterruptible power supply) products or square wave or "quasi sine wave" inverters **will damage the Alarm**. If you are not sure about your inverter or UPS type, please consult with the manufacturer to verify.

Heat Alarms cannot sense fires if the heat does not reach them. Heat from fires in chimneys or walls, on roofs, or on the other side of closed doors may not reach the sensing chamber and set off the alarm. That is why one unit should be installed on every floor, in the attic, basement and garage and only as a supplement to Smoke Alarms.

Heat Alarms may not sense heat from a fire on another level of the home. Example: a stand-alone unit on the second floor may not detect heat from a fire in a crawl space until the fire spreads. This may not give you enough time to escape safely. That is why recommended minimum protection is at least one Smoke Alarm on every level of your home and Heat Alarms in any areas not suitable for Smoke Alarms. Even with a unit on every floor, stand-alone units may not provide as much protection as interconnected units, especially if the fire starts in a remote area. Interconnected units may provide earlier warning than stand-alone units since all units alarm when one senses heat or smoke.

Heat Alarms may not be heard. The alarm horn loudness meets or exceeds the current UL standard. However, if the device is installed outside the bedroom, it may not wake up a sound sleeper or one who has recently used drugs or has been drinking alcoholic beverages. This is especially true if the door is closed or only partly open. Even persons who are awake may not hear the alarm horn if the sound is blocked by distance or closed doors. Noise from traffic, stereo, radio, television, air conditioner, or other appliances may also prevent alert persons from hearing the alarm horn. This alarm device is not intended for people who are hearing impaired.

Heat Alarms may not have time to alarm before the fire itself causes damage, injury, or death, since heat from some fires may not reach the unit immediately. Examples of this include persons smoking in bed, children playing with matches, or fires caused by violent explosions resulting from escaping gas.

This Heat Alarm is not foolproof. Like any electronic device, Heat Alarms are made of components that can wear out or fail at any time. You must test the unit weekly to ensure your continued protection. Heat Alarms cannot prevent or extinguish fires. They are not a substitute for property or life insurance.

Heat Alarms have a limited life. The unit should be replaced immediately if it is not operating properly. In no case should it be used for more than 10 years.

LIMITED WARRANTY

BRK Brands, Inc., ("BRK") the maker of BRK® brand and First Alert® brand products warrants that for a period of ten years from the date of purchase, this product will be free from defects in material and workmanship. BRK, at its option, will repair or replace this product or any component of the product found to be defective during the warranty period. Replacement will be made with a new or remanufactured product or component. If the product is no longer available, replacement may be made with a similar product of equal or greater value. This is your exclusive warranty.

This warranty is valid for the original retail purchaser from the date of initial retail purchase and is not transferable. Keep the original sales receipt. Proof of purchase is required to obtain warranty performance. BRK dealers, service centers, or retail stores selling BRK products do not have the right to alter, modify or any way change the terms and conditions of this warranty.

This warranty does not cover normal wear of parts or damage resulting from any of the following: negligent use or misuse of the product, use on improper voltage or current, use contrary to the operating instructions, disassembly, repair or alteration by anyone other than BRK or an authorized service center. Further, the warranty does not cover Acts of God, such as fire, flood, hurricanes and tornadoes or any batteries that are included with this unit.

BRK shall not be liable for any incidental or consequential damages caused by the breach of any express or implied warranty. Except to the extent prohibited by applicable law, any implied warranty of merchantability or fitness for a particular purpose is limited in duration to the duration of the above warranty. Some states, provinces or jurisdictions do not allow the exclusion or limitation of incidental or consequential damages or limitations on how long an implied warranty lasts, so the above limitations or exclusion may not apply to you. This warranty gives you specific legal rights, and you may also have other rights that vary from state to state or province to province.

How to Obtain Warranty Service

Service: If service is required, do not return the product to your retailer. In order to obtain warranty service, contact the Consumer Affairs Division at 1-800-323-9005, 7:30 AM - 5:00 PM Central Standard Time, Monday through Friday. To assist us in serving you, please have the model number and date of purchase available when calling. **For Warranty Service return to:** BRK Brands, Inc., 25 Spur Drive, El Paso, TX 79906

Battery: BRK Brands, Inc. make no warranty, express or implied, written or oral, including that of merchantability or fitness for any particular purpose with respect to battery.

Please record Date and Where Purchased:

BRK® is a registered trademark of BRK Brands, Inc.
First Alert® is a registered trademark of the First Alert Trust.