

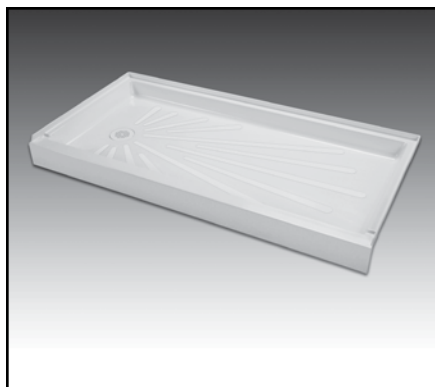

SEE PAGES 2-5 FOR A LIST OF ACCESSORIES!



Design features:

- Produced from high-grade, reinforced, molded fiberglass for optimum strength and impact resistance using matched metal molds under heat and pressure.
- Ideal for new or remodel projects...fits DURAWALL® Shower Walls (see Accessories section) as well as ceramic tile or preformed wall kit.
- Fits 60" wide by 30" deep alcove...same footprint as a standard bathtub
- Drain hole is offset 8-1/2" x 15" for connection to 2" DWV piping
- Easy entry 4-1/2" threshold
- Slip resistant Starburst® surface helps rapidly evacuate water to the drain
- Available in both LH and RH drain locations
- Available in white or bone
- Smooth, colorfast semi-gloss finish, resists scuffs.
- Mold and mildew-resistant...easy to clean
- Available STYLEMATE® shower enclosures feature tempered safety glass and a range of finishes (see Accessories section).

Code Accepted

- IAMPO® Listed
- American Society of Testing and Materials (ASTM) – D.635, E-84 and E-162 Fire Retardancy
- American National Standards Institute (ANSI) Specification Z 124-2011
- Inhalation Toxicity Test



Specifications

Model	Description	Drain Location	Fits Alcove	UPC
3060R	White	RH	30" x 60"	6 71031 00355 5
3060RBN	Bone	RH	30" x 60"	6 71031 00356 0
3060L	White	LH	30" x 60"	6 71031 00357 7
3060LBN	Bone	LH	30" x 60"	6 71031 00358 4

General: Furnish and install as shown on plans, CareGiver™ ShowerTub™ model 3060 as manufactured by E.L. Mustee & Sons, Inc. Floor to be one-piece, molded fiberglass, using matched metal molds under extreme heat and pressure. Surface to be slip-resistant design that does not interfere with flow of water. Size: 30" x 60". Flood level rim will be not less than 3" high. Tiling flange will extend not less than 1" higher than the threshold which is an integral molded water barrier. Threshold will be 4-1/2" high. Offset 2" drain hole on 8-1/2" by 15" centers to accept standard 1-1/2" tub waste. Available on right or left hand. Color ____ (White, Bone).

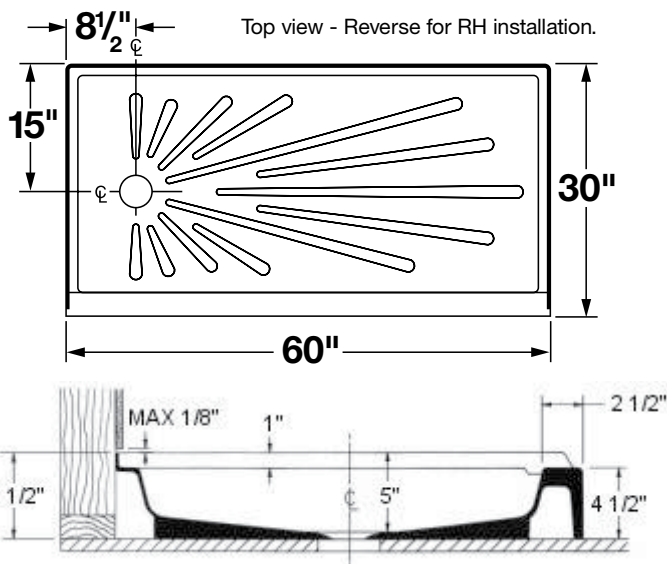



▶ **Drain Assemblies**

60.300A, 60.300ABN Drain Assembly

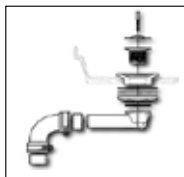

Model	Color	UPC
60.300A	White	6 71031 00392 8
60.300ABN	Bone	6 71031 00393 5

Use to replace bathtub waste line and connect to existing DWV sanitary pipe.

82.400A Drain Assembly

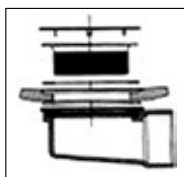

Model	Color	UPC
82.400A		6 71031 00220 4

PVC drain assembly for 1-1/2" PVC pipe solvent welded DWV sanitary pipe.

42.400A Drain Assembly



Model	Color	UPC
42.400A		

PVC drain assembly for 2" PVC pipe solvent welded DWV sanitary pipe.

42.317A, 42.320, 42.321 Drain Assembly

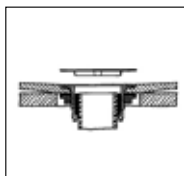

Model	Color	UPC
42.317A	Drain assembly	6 71031 00167 2
42.320 Optional	Drain for 2" copper (DWV)	6 71031 00309 6
42.321 Optional	Drain seal for 2" soil pipe (SW)	

Use to replace bathtub waste line and connect to existing DWV sanitary pipe.





▶ DURAWALL® Shower Walls

Mustee offers several premium-quality VARISTONE® fiberglass and DURAWALL® thermoplastic shower walls to best fit the needs of your Model 3060 ShowerTub™ Easy Access Shower Floor application.

572T VARISTONE™ — FIBERGLASS, 5-PANEL RECTANGULAR SHOWER WALLS, ADHESIVE MOUNT



Model No.	Description	UPC
572TWH	Widths to 60", depths to 34"	6 71031 00420 8
572TBN	Widths to 60", depths to 34"	6 71031 00421 5

Optional 572.300 VARISTONE® Shelves



Expressly produced to color match the finishes available for Mustee's Model 572T shower walls, VARISTONE® shelves adhesive mount to the walls in any desired position or arrangement to best meet your needs.

Model No.	Color	UPC
572.300	White	6 71031 00385 0
572.300BN	Bone	6 71031 00386 7

760T-30WHT DURAWALL® — PREMIUM FIBERGLASS, 5-PANEL RECTANGULAR SHOWER WALLS, DIRECT-TO-STUD MOUNT



Model No.	Description	UPC
760T-30WHT	Widths to 60", depths to 30"	—

To create a shelf at any location on this shower surround, purchase the optional 572.300 VARISTONE® shelf...see product description directly above.

260 DURAWALL® — THERMOPLASTIC, 5-PANEL RECTANGULAR SHOWER WALLS, ADHESIVE MOUNT



Model No.	Description	UPC
260WHT	Widths to 60", depths to 40"	6 71031 00053 8
260BN	Widths to 60", depths to 40"	6 71031 00050 7

265 DURAWALL® — THERMOPLASTIC, 5-PANEL RECTANGULAR SHOWER WALLS, ADHESIVE MOUNT



Model No.	Description	UPC
265WHT	Widths to 71", depths to 41-1/2"	6 71031 00478 9





▶ **CareGiver® Grab Bars**

A wide range of straight and angled 304 stainless steel grab bars in all popular styles, lengths and sizes are available to provide in-shower support and stability.

1½" DIA. INSIDE CORNER STYLES — SAFETY GRAB BARS

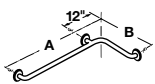

Model	A	Size	B	C	UPC
390.304	34"		18"	90°	6 71031 00362 1
390.303	42"		20"	90°	6 71031 00361 4

1½" DIA. STRAIGHT — SAFETY GRAB BARS



Model	Size	UPC
390.305	18"	6 71031 00452 9
390.301	24"	6 71031 00359 1
390.306	36"	6 71031 00434 5
390.307	42"	6 71031 00435 2
390.302	48"	6 71031 00360 7

1½" DIA. ANGLED — SAFETY GRAB BARS

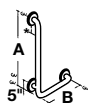

Model	A	Size	B	C	UPC
390.308	24"		16"	90°	6 71031 00436 9
390.309	32"		16"	90°	6 71031 00437 6

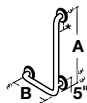

390.310	24"		16"	90°	6 71031 00438 3
390.311	32"		16"	90°	6 71031 00439 0

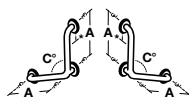

390.312	30"			90°	6 71031 00440 6
390.313	12"		No Corner Flange	120°	6 71031 00441 3
390.314	16"			120°	6 71031 00442 0
390.315	24"			120°	6 71031 00443 7

Rotate for RH or LH use

▶ **CareGiver® Fold-Down Shower Seats**

CareGiver® Fold-Down Shower Seats can be ordered in Right hand, Left hand and Rectangular Fold-Down and Leg-supported styles. All popular sizes are available to provide a stable, secure place to sit while showering.

LEFT-HAND SEAT
— WALL MOUNT

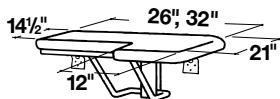

Model	Size	UPC
390.402	26" x 21"	6 71031 00364 5

RIGHT-HAND SEAT
— WALL MOUNT



Model	Size	UPC
390.401	26" x 21"	6 71031 00363 8

LEFT-HAND SEAT
— WITH LEGS

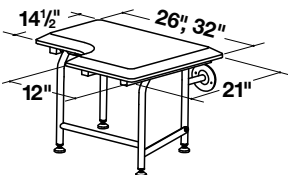

390.405	26" x 21"	6 71031 00444 4
---------	-----------	-----------------

RIGHT-HAND SEAT
— WITH LEGS

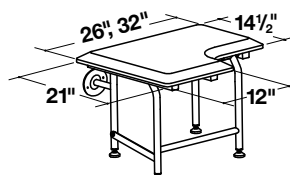

390.407	26" x 21"	6 71031 00446 8
---------	-----------	-----------------

Continued on next page »



► **CareGiver® Fold-Down Shower Seats** (continued)

CareGiver® Fold-Down Shower Seats can be ordered in Right hand, Left hand and Rectangular Fold-Down and Leg-supported styles. All popular sizes are available to provide a stable, secure place to sit while showering.

RECTANGULAR SEAT
— WALL MOUNT

390.409 26" x 14½" 6 71031 00448 2



RECTANGULAR SEAT
— WITH LEGS

390.411 26" x 14½" 6 71031 00450 5

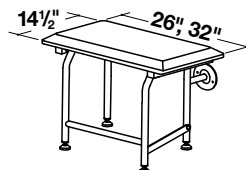

► **STYLEMATE® By-Pass Framed and By-Pass Frameless Enclosures**

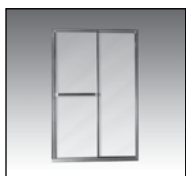

Model No.	Finish	Glass	Height	Opening	UPC
Framed Design					
60.403	Chrome	Clear	69"	59"	6 71031 00472 7
60.404	Brushed Nickel	Clear	69"	59"	6 71031 00473 4
60.405	Oil-Rubbed Bronze	Clear	69"	59"	6 71031 00474 1
Frameless Design					
60.406	Chrome	Clear	69"	59"	6 71031 00475 8
60.407	Brushed Nickel	Clear	69"	59"	6 71031 00476 5
60.408	Oil-Rubbed Bronze	Clear	69"	59"	6 71031 00477 2

► **GapSeal-Pro™ — For all shower floors and bathtubs**



Model No.	Description	UPC
60.320A	132" long x 2" tall	6 71031 00496 3

The flexible PVC GapSeal-Pro™ features a strong adhesive strip that allows it to be easily positioned to "extend" the tile flange and effectively seal the gap between drywall or like-surfaces on shower floors or bathtubs. Patent pending.

