

# D-LINE®

## Trade

### Innovative Cable Management

**INCLUDING RACEWAYS FOR LOW-VOLTAGE CABLES**

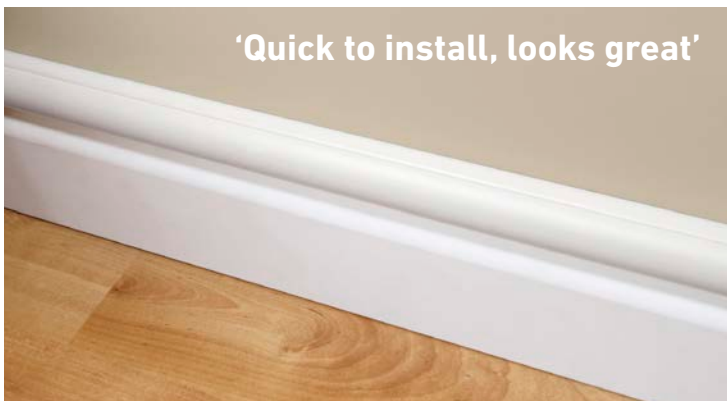

**'When time, safety & appearance matter'**



### **D-Line USA, Inc is a Louisville based company with a global reputation for innovative cable management solutions.**

Across the world our patented ranges are used every day to route surface mounted cables, 'when time, safety and appearance matter'. Core offers include designer raceways for low-voltage cables, innovative fasteners, and floor cable protectors.

Being 'quick-to-install & look great!' D-Line pvc raceways provide an attractive alternative to traditional pvc raceways which often look unfashionable in modern decor.

D-Line's combination of speed, safety and style is ideal for low-voltage telecom and data cabling, audio visual projects, and security alarm installs.

The quality of finish makes satisfied customers for repetitive revenues!

Also in our range is innovative steel cable fasteners. All have installer-friendly designs, for easy fixing of cables direct-to-surface.

D-Line's selection of Floor Cable Protectors are available in 6' or 30' lengths. They uncoil to lay flat, and are supplied with push-in pull-out connectors that can join to additional lengths... giving peace-of-mind by covering any length of cable! Rigid versions are available also.

Products are made in USA and UK, and manufactured to exacting standards. This brochure highlights popular offers that we hope meet with your approval.

D-Line will be delighted to be of service, and promise our best always.

**D-Line Trade Team**



**Stocks on hand & ready to ship**

## D-Line Raceway - A Quick Guide



### Designer shapes and colors

Subtle appearance with no sharp edges; to blend with decor  
Alternative cable capacities satisfy popular demands  
Color options to provide a striking feature!  
Available as ½-round (width x height) 0.63" x 0.31",  
0.78" x 0.39", 1.18" x 0.59", & 2" x 1"... ¼-round 0.87" x 0.87"  
Also rectangular 0.4" x 0.31" 2 piece design



### Film covered, PVC lengths

Keeps lengths pristine before installation  
PVC lengths, UV stabilized  
Strong, but easy to cut



### Self-adhesive

Simply peel & stick  
Can be drilled & screw-fixed also



### Patented single-piece design

For quick & easy handling  
Tensioned hinge lid retains cables during installation  
Hinge is not overly stiff or slack; can be opened/closed  
countless times - easy to later add or remove cables  
Lids will never peel or detach - maintenance friendly



All Clip-Over accessories have grip tabs.  
The grip tab simply clips over the top of the length

### Accessories

Snap-on design with rear grip tabs clip-over lengths  
to hold corner bend & tee accessories securely  
Smooth-fit connectors & end caps

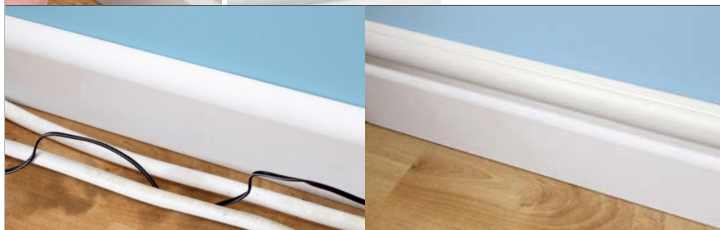

### Easy-clean profile

No flat dust-ledges  
Only one groove,  
for infection control  
Easily wipes clean



### Paintable

Can blend with any decor

## CLIP-OVER BENDS & TEES



## CONNECTORS & END CAPS



## Raceway Overview, for low voltage cables

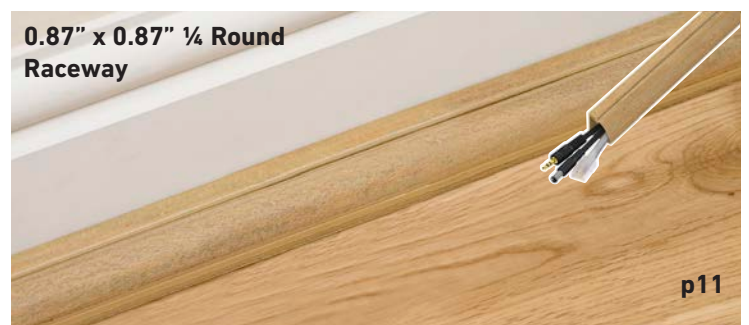

## Rectangular Raceway - 0.4" x 0.31"

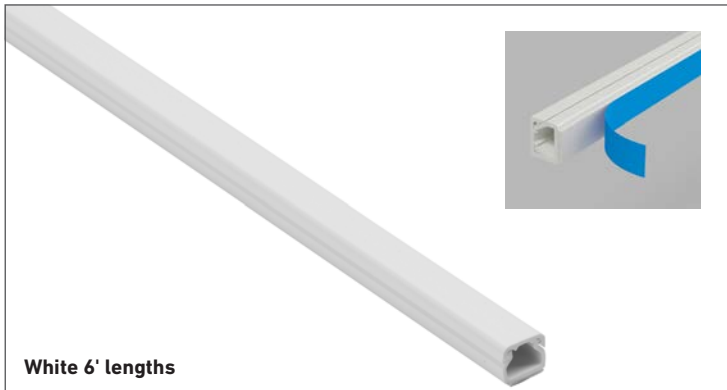

**D-Line 0.4" x 0.31"** is an ultra-slim profile for the smallest of cables, & suitable for tight spaces.

Ideal for alarm cables, bellwire, telephone & speaker cables.

- Rectangular profile, 0.4" x 0.31" (WxH)
- Clip-on lid
- Corners can be mitre-cut
- Self-adhesive
- Paintable



Part No.	Description
R6FT108WSA	0.4x0.31in White Rectangular PVC Raceway - 1x 6' (72") Length, Self adhesive

# Micro Raceway - 0.63" x 0.31"

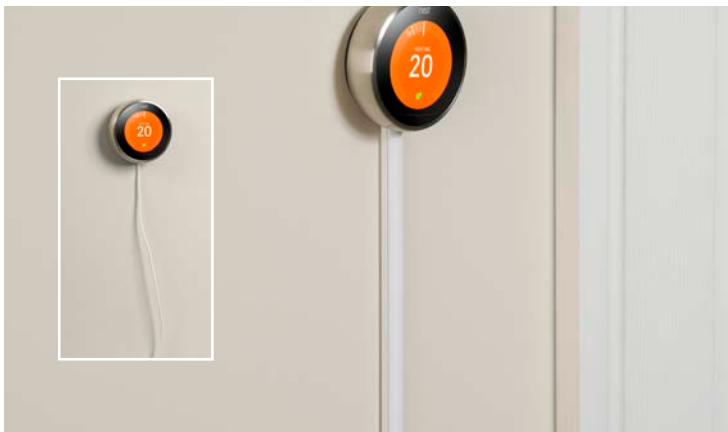

To hide speaker cable, bell wires, telephone and alarm cable, Micro Raceway offers a discreet solution.

Available in white or almond and with a range of smooth-fit accessories; that give a smooth flush appearance.

- Micro ½ round profile, only 0.63" x 0.31" (WxH)
- Patented hinge & click-lock lid
- Smooth-fit accessories available for perfect finish
- Self-adhesive, or can be drilled & screw-fixed

### Full range of accessories available



Part No.	Description
US/D21608W	0.63x0.31in White Micro PVC Raceway - 1x 6.56ft (79"/2m) Length, Self-Adhesive
US/6FT1608W	0.63x0.31in White Micro PVC Raceway - 1x 6ft (72"/1.8m) Length, Self-Adhesive
FB1608W	0.63x0.31in White Micro PVC Raceway Smooth-Fit Flat Corner (sold as individual pieces - i.e. \$ per 1 pc)
IB1608W	0.63x0.31in White Micro PVC Raceway Smooth-Fit Internal Corner (sold as individual pieces - i.e. \$ per 1 pc)
EB1608W	0.63x0.31in White Micro PVC Raceway Smooth-Fit External Corner (sold as individual pieces - i.e. \$ per 1 pc)
NET1608W	0.63x0.31in White Micro PVC Raceway Smooth-Fit Equal Tee (sold as individual pieces - i.e. \$ per 1 pc)
NCP1608W	0.63x0.31in White Micro PVC Raceway Smooth-Fit Connector (sold as individual pieces - i.e. \$ per 1 pc)
EC1608W	0.63x0.31in White Micro PVC Raceway Smooth-Fit End Cap (sold as individual pieces - i.e. \$ per 1 pc)
US/6FT1608M	0.63x0.31in Almond Micro PVC Raceway - 1x 6ft (72"/1.8m) Length, Self-Adhesive
FB1608M	0.63x0.31in Almond Micro PVC Raceway Smooth-Fit Flat Corner (sold as individual pieces - i.e. \$ per 1 pc)
IB1608M	0.63x0.31in Almond Micro PVC Raceway Smooth-Fit Internal Corner (sold as individual pieces - i.e. \$ per 1 pc)
EB1608M	0.63x0.31in Almond Micro PVC Raceway Smooth-Fit External Corner (sold as individual pieces - i.e. \$ per 1 pc)
NET1608M	0.63x0.31in Almond Micro PVC Raceway Smooth-Fit Equal Tee (sold as individual pieces - i.e. \$ per 1 pc)
NCP1608M	0.63x0.31in Almond Micro PVC Raceway Smooth-Fit Connector (sold as individual pieces - i.e. \$ per 1 pc)
EC1608M	0.63x0.31in Almond Micro PVC Raceway Smooth-Fit End Cap (sold as individual pieces - i.e. \$ per 1 pc)

# Micro+ Raceway - 0.78" x 0.39"



**D-Line 0.78" x 0.39" Micro+ profile gives a neat solution for telecom cables, while offering internal capacity that can be useful around corners.**

Clip-over bends and tees are available to provide a perfect finish, while being quick & easy to install!

Ideal for flexible cables (up to 0.31" outer diameter), also fibre-optic, satellite/aerial, and broadband cable installations.

- Discreet and stylish appearance; only 0.78" x 0.39" (WxH)
- Patented hinge & click-lock lid
- Accessories available for perfect finish. Snap on bends & tees
- Self-adhesive, or can be drilled & screw-fixed

### Full range of accessories available



Part No.	Description
<b>US/D22010W</b>	0.78x0.39in White Micro PVC Raceway - 1x 6.56ft (79"/2m) Length, Self-Adhesive
<b>US/6FT2010W</b>	0.78x0.39in White Micro PVC Raceway - 1x 6ft Length, Self-Adhesive
<b>US/FLFB2010W-5PK</b>	0.78x0.39in White Micro PVC Raceway Clip-Over Flat Corner - Pack of 5 (sold as packs of 5 - i.e. \$ per 5 pcs)
<b>US/FLIB2010W-5PK</b>	0.78x0.39in White Micro PVC Raceway Clip-Over Internal Corner - Pack of 5 (sold as packs of 5 - i.e. \$ per 5 pcs)
<b>US/FLEB2010W-5PK</b>	0.78x0.39in White Micro PVC Raceway Clip-Over External Corner - Pack of 5 (sold as packs of 5 - i.e. \$ per 5 pcs)
<b>US/FLET2010W-5PK</b>	0.78x0.39in White Micro PVC Raceway Clip-Over Equal Tee - Pack of 5 (sold as packs of 5 - i.e. \$ per 5 pcs)
<b>US/CP2010W-5PK</b>	0.78x0.39in White Micro PVC Raceway Smooth-Fit Connector - Pack of 5 (sold as packs of 5 - i.e. \$ per 5 pcs)
<b>US/EC2010W-5PK</b>	0.78x0.39in White Micro PVC Raceway Smooth-Fit End Cap - Pack of 5 (sold as packs of 5 - i.e. \$ per 5 pcs)
<b>US/6FT2010M</b>	0.78x0.39in Almond Micro PVC Raceway - 1x 6ft Length, Self-Adhesive
<b>FLFB2010M</b>	0.78x0.39in Almond Micro PVC Raceway Clip-Over Flat Corner (sold as individual pieces - i.e. \$ per 1 pc)
<b>FLIB2010M</b>	0.78x0.39in Almond Micro PVC Raceway Clip-Over Internal Corner (sold as individual pieces - i.e. \$ per 1 pc)
<b>FLEB2010M</b>	0.78x0.39in Almond Micro PVC Raceway Clip-Over External Corner (sold as individual pieces - i.e. \$ per 1 pc)
<b>FLET2010M</b>	0.78x0.39in Almond Micro PVC Raceway Clip-Over Equal Tee
<b>CP2010M</b>	0.78x0.39in Almond Micro PVC Raceway Smooth-Fit Connector (sold as individual pieces - i.e. \$ per 1 pc)
<b>EC2010M</b>	0.78x0.39in Almond Micro PVC Raceway Smooth-Fit End Cap (sold as individual pieces - i.e. \$ per 1 pc)

# Mini Raceway - 1.18" x 0.59"



## D-Line 1.18" x 0.59" Mini Raceway offers a subtle appearance that makes surface cable installations look attractive!

The ½ round shape can blend to resemble the natural top-section of baseboards, while offering a modern solution for vertical cable drops and runs across ceilings.

Available white or almond, D-Line raceways can blend with surrounds.

- Unique stylish 'D-Line' appearance
- Patented hinge & click-lock lid
- Accessories available for perfect finish. Snap on bends & tees
- Self-adhesive, or can be drilled & screw-fixed

### Full range of accessories available

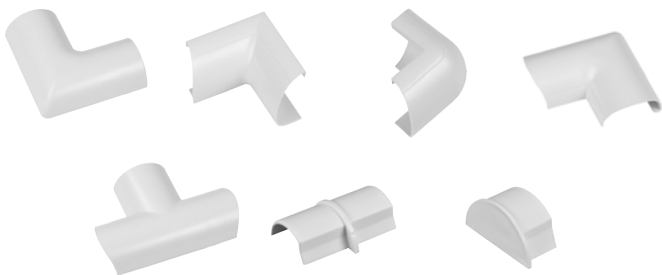

Part No.	Description
US/3D3015W	1.18x.59in (30x15mm) White Mini PVC Raceway - 1x 9.84ft (118'/3m) Length, Self-Adhesive
US/D23015W	1.18x.59in (30x15mm) White Mini PVC Raceway - 1x 6.56ft (79'/2m) Length, Self-Adhesive
US/6FT3015W	1.18x.59in (30x15mm) White Mini PVC Raceway - 1x 6ft Length, Self-Adhesive
US/FLFB3015W-2PK	1.18x.59in (30x15mm) White Mini PVC Raceway Clip-Over Flat Corner - Pack of 2 (sold as packs of 2 - i.e. \$ per 2 pcs)
US/FLEB3015W-2PK	1.18x.59in (30x15mm) White Mini PVC Raceway Clip-Over External Corner - Pack of 2 (sold as packs of 2 - i.e. \$ per 2 pcs)
US/FLIB3015W-2PK	1.18x.59in (30x15mm) White Mini PVC Raceway Clip-Over Internal Corner - Pack of 2 (sold as packs of 2 - i.e. \$ per 2 pcs)
US/FLET3015W-2PK	1.18x.59in (30x15mm) White Mini PVC Raceway Clip-Over Equal Tee - Pack of 2 (sold as packs of 2 - i.e. \$ per 2 pcs)
US/FLDB3015W-2PK	1.18x.59in (30x15mm) White Mini PVC Raceway Clip-Over Door Top Corner - Pack of 2 (sold as packs of 2 - i.e. \$ per 2 pcs)
US/CP3015W-5PK	1.18x.59in (30x15mm) White Mini PVC Raceway Smooth-Fit Connector - Pack of 5 (sold as packs of 5 - i.e. \$ per 5 pcs)
US/EC3015W-5PK	1.18x.59in (30x15mm) White Mini PVC Raceway Smooth-Fit End Cap - Pack of 5 (sold as packs of 5 - i.e. \$ per 5 pcs)
US/6FT3015M	1.18x.59in (30x15mm) Almond Mini PVC Raceway - 1x 6ft Length, Self-Adhesive
FLFB3015M	1.18x.59in (30x15mm) Almond Mini PVC Raceway Clip-Over Flat Corner (sold as individual pieces - i.e. \$ per 1 pc)
FLEB3015M	1.18x.59in (30x15mm) Almond Mini PVC Raceway Clip-Over External Corner (sold as individual pieces - i.e. \$ per 1 pc)
FLIB3015M	1.18x.59in (30x15mm) Almond Mini PVC Raceway Clip-Over Internal Corner (sold as individual pieces - i.e. \$ per 1 pc)
FLET3015M	1.18x.59in (30x15mm) Almond Mini PVC Raceway Clip-Over Equal Tee (sold as individual pieces - i.e. \$ per 1 pc)
FLDB3015M	1.18x.59in (30x15mm) Almond Mini PVC Raceway Clip-Over Door Top Corner (sold as individual pieces - i.e. \$ per 1 pc)
CP3015M	1.18x.59in (30x15mm) Almond Mini PVC Raceway Smooth-Fit Connector (sold as individual pieces - i.e. \$ per 1 pc)

# Maxi Raceway - 2" x 1"

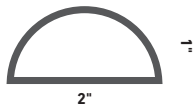

## D-Line 2" x 1" Maxi is a versatile Raceway, providing capacity for several cables.

The size, capacity, and white or black options makes this profile a market-leading solution that is ideal for many AV and datacoms projects.

- Unique stylish 'D-Line' appearance
- Patented hinge & click-lock lid
- Accessories available for perfect finish. Snap on bends & tees
- Self-adhesive, or can be drilled & screw-fixed (as recommended for best practice)
- Saves channeling walls

### Full range of accessories available



Part No.	Description
<b>US/5FT5025W</b>	2x1in (50x25mm) White Maxi PVC Raceway - 1x 5ft (60"/1.5m) Length, Self-Adhesive
<b>FLIB5025W</b>	2x1in (50x25mm) White PVC Raceway Clip-Over Internal Corner (sold as individual pieces - i.e. \$ per 1 pc)
<b>FLEB5025W</b>	2x1in (50x25mm) White PVC Raceway Clip-Over External Corner (sold as individual pieces - i.e. \$ per 1 pc)
<b>FLFB5025W</b>	2x1in (50x25mm) White PVC Raceway Clip-Over Flat Corner (sold as individual pieces - i.e. \$ per 1 pc)
<b>FLET5025W</b>	2x1in (50x25mm) White PVC Raceway Clip-Over Equal Tee (sold as individual pieces - i.e. \$ per 1 pc)
<b>CP5025W</b>	2x1in (50x25mm) White PVC Raceway Smooth-Fit Connector (sold as individual pieces - i.e. \$ per 1 pc)
<b>EC5025W</b>	2x1in (50x25mm) White PVC Raceway Smooth-Fit End Cap (sold as individual pieces - i.e. \$ per 1 pc)
<b>US/5FT5025B</b>	2x1in (50x25mm) Black Maxi PVC Raceway - 1x 5ft (60"/1.5m) Length, Self-Adhesive
<b>FLIB5025B</b>	2x1in (50x25mm) Black PVC Raceway Clip-Over Internal Corner (sold as individual pieces - i.e. \$ per 1 pc)
<b>FLEB5025B</b>	2x1in (50x25mm) Black PVC Raceway Clip-Over External Corner (sold as individual pieces - i.e. \$ per 1 pc)
<b>FLFB5025B</b>	2x1in (50x25mm) Black PVC Raceway Clip-Over Flat Corner (sold as individual pieces - i.e. \$ per 1 pc)
<b>FLET5025B</b>	2x1in (50x25mm) Black PVC Raceway Clip-Over Equal Tee (sold as individual pieces - i.e. \$ per 1 pc)
<b>CP5025B</b>	2x1in (50x25mm) Black PVC Raceway Smooth-Fit Connector (sold as individual pieces - i.e. \$ per 1 pc)
<b>EC5025B</b>	2x1in (50x25mm) Black PVC Raceway Smooth-Fit End Cap (sold as individual pieces - i.e. \$ per 1 pc)

## TV Raceway - 2.36" x 0.59"

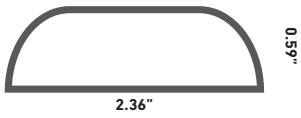

To contain cables from wall mount TV's, this patent pending Cable Cover has one-piece design with a hidden hinge and click-lock feature in design with a seamless front.

Self-adhesive backing for simple peel & stick installation, with stylish low-profile shape that blends with decor.

- Capacity for several TV cables
- Smooth and seamless front
- Easy to add or remove cables
- Integral divider, for power & HDMI cable compartments
- Stylish low-profile design
- Peel & stick (or can be screw-fixed)

Part No.	Description
US/1D6015W	1x 39" Seamless Length, Hinge & Click Lock, Self-Adhesive - White
US/1D6015M	1x 39" Seamless Length, Hinge & Click Lock, Self-Adhesive - Almond
US/1D6015B	1x 39" Seamless Length, Hinge & Click Lock, Self-Adhesive - Black

# 1/4 Round Raceway - 0.87" x 0.87"



**Quarter round 0.87" x 0.87" profile covers expansion gaps between floors and baseboards, while providing an easy-to-use cable raceway around floor perimeters, or worktops.**

The 0.87" x 0.87" (W x H) dimensions scale well to blend with popular baseboards, while providing capacity for cable bending radii around corners.

- Unique stylish 'D-Line' appearance
- Patented hinge & click-lock lid
- Accessories available for perfect finish
- A smart alternative to traditional floor trims

### Full range of accessories available

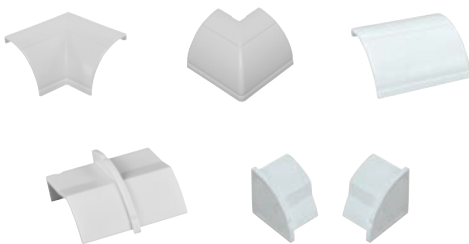

Part No.	Description
US/D222QSW	0.87x0.87in (22x22mm) White 1/4-Round PVC Raceway - 1x 6.56ft (79"/2m) Length, Self-Adhesive
US/6FT22QSW	0.87x0.87in (22x22mm) White 1/4-Round PVC Raceway - 1x 6.ft (72"/1.8m) Length, Self-Adhesive
FLIB22QSW	0.87x0.87in (22x22mm) White 1/4-Round PVC Raceway Clip-Over Internal Corner (sold as individual pieces - i.e. \$ per 1 pc)
FLEB22QSW	0.87x0.87in (22x22mm) White 1/4-Round PVC Raceway Clip-Over External Corner (sold as individual pieces - i.e. \$ per 1 pc)
FLC022QSW	0.87x0.87in (22x22mm) White 1/4-Round PVC Raceway Clip-Over Inlet/Outlet Connector (sold as individual pieces - i.e. \$ per 1 pc)
CP22QSW	0.87x0.87in (22x22mm) White 1/4-Round PVC Raceway Smooth-Fit Connector (sold as individual pieces - i.e. \$ per 1 pc)
EC22QSW/L	0.87x0.87in (22x22mm) White 1/4-Round PVC Raceway Smooth-Fit End Cap (Left) (sold as individual pieces - i.e. \$ per 1 pc)
EC22QSW/R	0.87x0.87in (22x22mm) White 1/4-Round PVC Raceway Smooth-Fit End Cap (Right) (sold as individual pieces - i.e. \$ per 1 pc)
US/D222QSP	0.87x0.87in (22x22mm) Wood-effect 1/4-Round PVC Raceway - 1x 6.56ft (79"/2m) Length, Self-Adhesive
FLIB22QSP	0.87x0.87in (22x22mm) Wood-effect 1/4-Round PVC Raceway Clip-Over Internal Corner (sold as individual pieces - i.e. \$ per 1 pc)
FLEB22QSP	0.87x0.87in (22x22mm) Wood-effect 1/4-Round PVC Raceway Clip-Over External Corner (sold as individual pieces - i.e. \$ per 1 pc)
FLC022QSP	0.87x0.87in (22x22mm) Wood-effect 1/4-Round PVC Raceway Clip-Over Inlet / Outlet Connector (sold as individual pieces - i.e. \$ per 1 pc)
CP22QSP	0.87x0.87in (22x22mm) Wood-effect 1/4-Round PVC Raceway Smooth-Fit Connector (sold as individual pieces - i.e. \$ per 1 pc)
EC22QSP/L	0.87x0.87in (22x22mm) Wood-effect 1/4-Round PVC Raceway Smooth-Fit End Cap (Left) (sold as individual pieces - i.e. \$ per 1 pc)
EC22QSP/R	0.87x0.87in (22x22mm) Wood-effect 1/4-Round PVC Raceway Smooth-Fit End Cap (Right) (sold as individual pieces - i.e. \$ per 1 pc)

## Direct-to-surface Steel Fixings Adjustable Cable & Conduit Clips

For 0.39" - 0.63"  
cable diameter

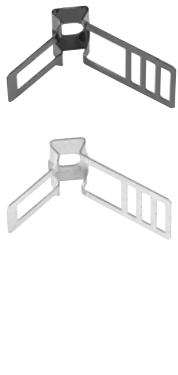

For 0.63" - 0.83"  
cable diameter

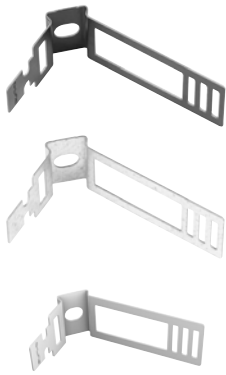

For 0.87" - 1.02"  
cable diameter

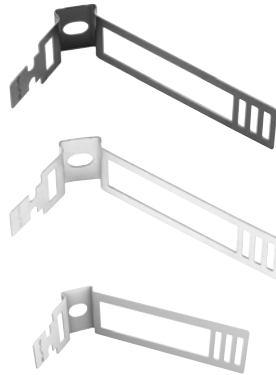

- Wrap & lock
- One fixing only - labor-saving design
- Screw-fixing becomes 'invisible'
- User-friendly, pliable steel
- 'Quick to install, looks great!'

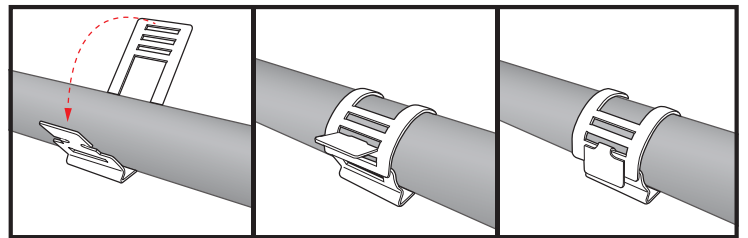

Drill a 3/16" (0.1875") pilot hole



Secure screw-fix,  
no wall plug required



Simply wrap around the cable



Secure cable with locking tab



Tight fitment, neat appearance



Tested to survive 2 hours at  
1780°F in fire conditions

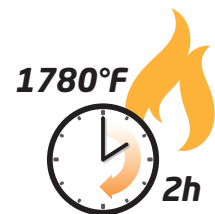

Part No.	Description
US/SD-CAB10/20	Safe-D Adjustable Cable/Conduit Clips 0.39-0.63in (10-15mm) Galv. - Pack of 20 (i.e. \$ per 20 pcs)
US/SD-CAB10B/20	Safe-D Adjustable Cable/Conduit Clips 0.39-0.63in (10-15mm) Black - Pack of 20 (i.e. \$ per 20 pcs)
US/SD-CAB16/20	Safe-D Adjustable Cable/Conduit Clips 0.63-0.83in (16-21mm) Galv. - Pack of 20 (i.e. \$ per 20 pcs)
US/SD-CAB16B/20	Safe-D Adjustable Cable/Conduit Clips 0.63-0.83in (16-21mm) Black - Pack of 20 (i.e. \$ per 20 pcs)
US/SD-CAB16W/20	Safe-D Adjustable Cable/Conduit Clips 0.63-0.83in (16-21mm) White - Pack of 20 (i.e. \$ per 20 pcs)
US/SD-CAB22/20	Safe-D Adjustable Cable/Conduit Clips 0.87-1.02in (22-26mm) Galv. - Pack of 20 (i.e. \$ per 20 pcs)
US/SD-CAB22B/20	Safe-D Adjustable Cable/Conduit Clips 0.87-1.02in (22-26mm) Black - Pack of 20 (i.e. \$ per 20 pcs)
US/SD-CAB22W/20	Safe-D Adjustable Cable/Conduit Clips 0.87-1.02in (22-26mm)White - Pack of 20 (i.e. \$ per 20 pcs)

## Direct-to-surface Steel Fixings Flat Cable 'Grip Clips'

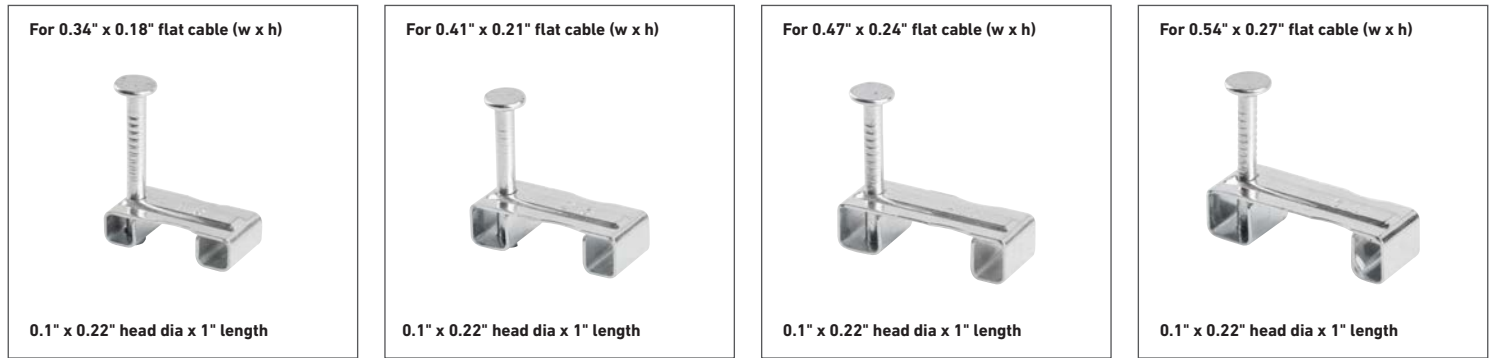

- User-friendly design - keeps finger & thumb away from hammer
- 0.1" nail dia; suitable for harder substrates (will not buckle)
- 4x sizes for tight fitments
- Raised strip on clip-head prevents cable bruising if mis-hit!



Part No.	Description
US/SD-TE1.5/100	Grip Clip c/w Nail Pack of 100 (i.e. \$ per 100 pcs) - for 0.34" x 0.18" flat cable (w x h)
US/SD-TE2.5/100	Grip Clip c/w Nail Pack of 100 (i.e. \$ per 100 pcs) - for 0.41" x 0.21" flat cable (w x h)
US/SD-TE4.0/100	Grip Clip c/w Nail Pack of 100 (i.e. \$ per 100 pcs) - for 0.47" x 0.24" flat cable (w x h)
US/SD-TE6.0/100	Grip Clip c/w Nail Pack of 100 (i.e. \$ per 100 pcs) - for 0.54" x 0.27" flat cable (w x h)

## Direct-to-surface Steel Fixings Stag Clips - Single-Piece Fixings



Single options (Red, Galv, Black)  
for 0.24" - 0.31", & 0.31" - 0.39" o/d cables

Twin options (Red, Galv, Black)  
for 0.24" - 0.31", & 0.31" - 0.39" o/d cables

Tested to survive 2 hours at  
1780°F in fire conditions

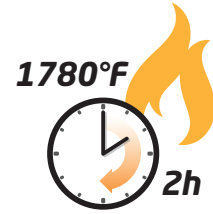

- Can be 1st fix rested in pilot hole, before 2nd fix inserting cable(s)
- No screw or wall anchor required, simply push smooth head into pilot hole, 0.22" or 0.24" x 1.18" deep
- Head sections overlap for secure cable fitment. 2x cable versions lock together when overlapped
- Supplied in bags of 50 pcs



Drill pilot hole & select appropriate size of Stag Clip



Rest Stag Clip in the pilot hole ready to accept cable(s)



Insert cable(s) before squeezing the smooth head

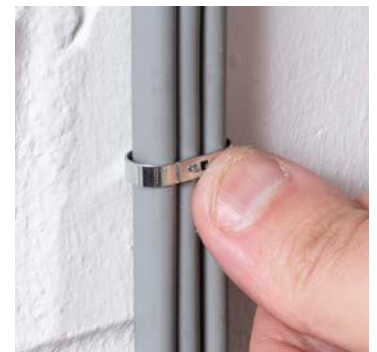

Push home to secure the Stag Clip and cable(s)

Part No.	Description
US/SD-STAG6S/50	Safe-D Sprung Steel Stag-Clip 0.24-0.31in (6-8mm) Single Galv. - Pack of 50 (i.e. \$ per 50 pcs)
US/SD-STAG6SR/50	Safe-D Sprung Steel Stag-Clip 0.24-0.31in (6-8mm) Single Red - Pack of 50 (i.e. \$ per 50 pcs)
US/SD-STAG6SB/50	Safe-D Sprung Steel Stag-Clip 0.24-0.31in (6-8mm) Single Black - Pack of 50 (i.e. \$ per 50 pcs)
US/SD-STAG8S/50	Safe-D Sprung Steel Stag-Clip 0.31-0.39in (8-10mm) Single Galv. - Pack of 50 (i.e. \$ per 50 pcs)
US/SD-STAG8SR/50	Safe-D Sprung Steel Stag-Clip 0.31-0.39in (8-10mm) Single Red - Pack of 50 (i.e. \$ per 50 pcs)
US/SD-STAG8SB/50	Safe-D Sprung Steel Stag-Clip 0.31-0.39in (8-10mm) Single Black - Pack of 50 (i.e. \$ per 50 pcs)
US/SD-STAG6T/50	Safe-D Sprung Steel Stag-Clip 0.24-0.31in (6-8mm) Twin Galv. - Pack of 50 (i.e. \$ per 50 pcs)
US/SD-STAG6TR/50	Safe-D Sprung Steel Stag-Clip 0.24-0.31in (6-8mm) Twin Red - Pack of 50 (i.e. \$ per 50 pcs)
US/SD-STAG6TB/50	Safe-D Sprung Steel Stag-Clip 0.24-0.31in (6-8mm) Twin Black - Pack of 50 (i.e. \$ per 50 pcs)
US/SD-STAG8T/50	Safe-D Sprung Steel Stag-Clip 0.31-0.39in (8-10mm) Twin Galv. - Pack of 50 (i.e. \$ per 50 pcs)
US/SD-STAG8TR/50	Safe-D Sprung Steel Stag-Clip 0.31-0.39in (8-10mm) Twin Red - Pack of 50 (i.e. \$ per 50 pcs)
US/SD-STAG8TB/50	Safe-D Sprung Steel Stag-Clip 0.31-0.39in (8-10mm) Twin Black - Pack of 50 (i.e. \$ per 50 pcs)

## Direct-to-surface Steel Fixings F-Clips - Flat, Flexible, Foldable & Fire-Rated

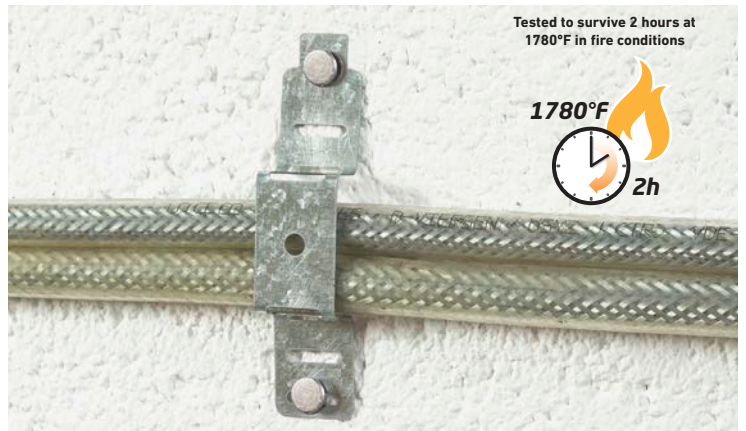
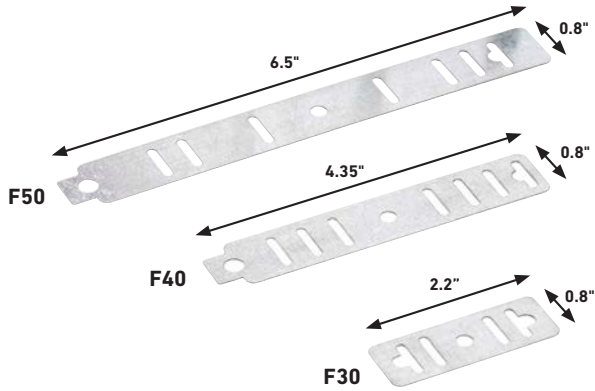

- Space efficient and pocket friendly
- Uniquely versatile - many possibilities
- Easy folding to required shape, to suit space & cable volume
- 3x fixing holes, 0.22" (5.7mm) diameter
- F-Clip 40 and 50 locking tabs can be return-folded for extra security if preferred
- Slots enable use as a cable tie base

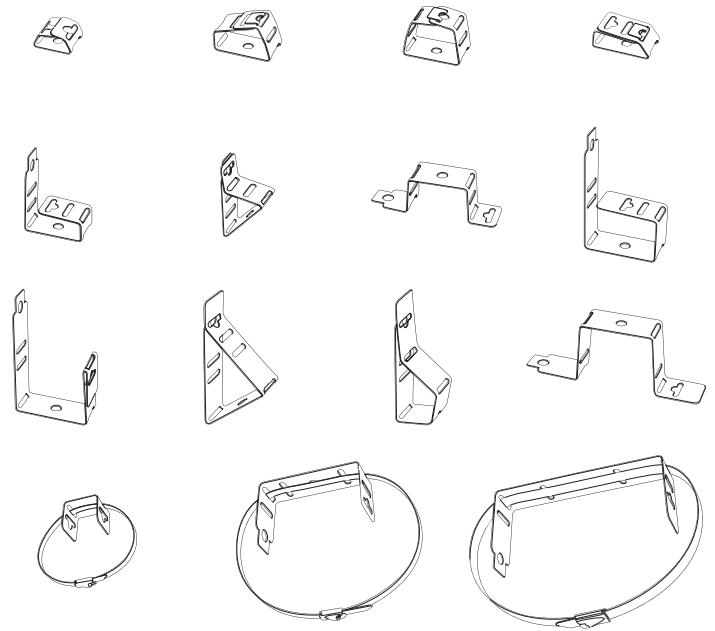

Part No.	Description
US/SAFEDFCLIP30/100	Safe-D Foldable Steel F-Clip 30 - Pack of 100 (i.e. \$ per 100 pcs)
US/SAFEDFCLIP40/50	Safe-D Foldable Steel F-Clip 40 - Pack of 50 (i.e. \$ per 50 pcs)
US/SAFEDFCLIP50/50	Safe-D Foldable Steel F-Clip 50 - Pack of 50 (i.e. \$ per 50 pcs)

# Floor Cable Protectors

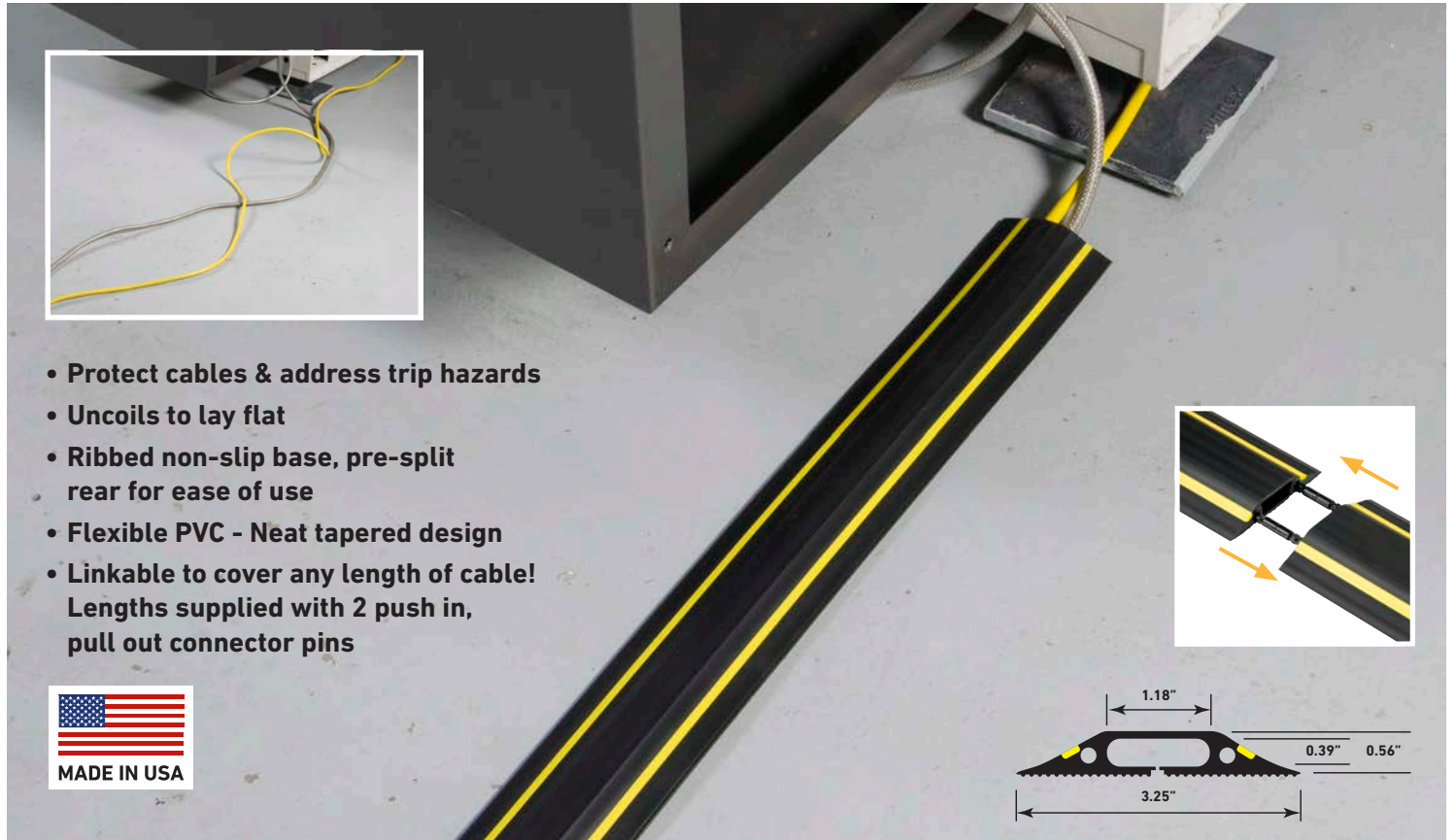
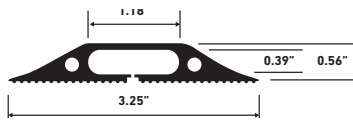

- Protect cables & address trip hazards
- Uncoils to lay flat
- Ribbed non-slip base, pre-split rear for ease of use
- Flexible PVC - Neat tapered design
- Linkable to cover any length of cable! Lengths supplied with 2 push in, pull out connector pins

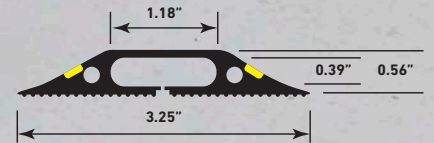

30' option

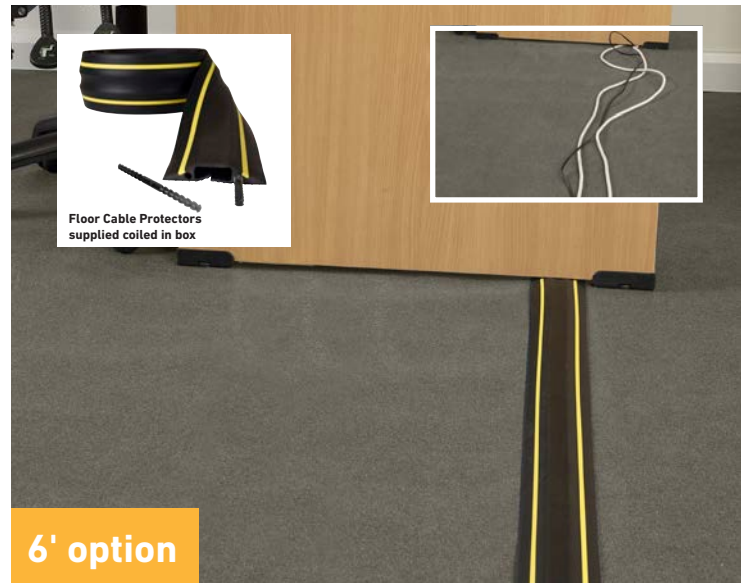

6' option

Part No.	Description
US/FC68B	Medium Duty Black Floor Cable Cover - 6ft (1.8m), Cavity 0.56" x 0.35" (14x9mm), c/w 2x Connectors
US/FC68B/9M	Medium Duty Black Floor Cable Cover - 30ft (1.8m), Cavity 0.56" x 0.35" (14x9mm), c/w 2x Connectors
US/FC83B	Medium Duty Black Floor Cable Cover - 6ft (1.8m), Cavity 1.18" x 0.37" (30x10mm), c/w 2x Connectors
US/FC83B/9M	Medium Duty Black Floor Cable Cover - 30ft (9m), Cavity 1.18" x 0.37" (30x10mm), c/w 2x Connectors
US/FC83H	Medium Duty Black & Yellow Floor Cable Cover - 6ft (1.8m), 1.18" x 0.37" (30x10mm), c/w 2x Connectors
US/FC83H/9M	Medium Duty Black & Yellow Floor Cable Cover - 30ft (9m), 1.18" x 0.37" (30x10mm), c/w 2x Connectors

## Floor Cable Covers

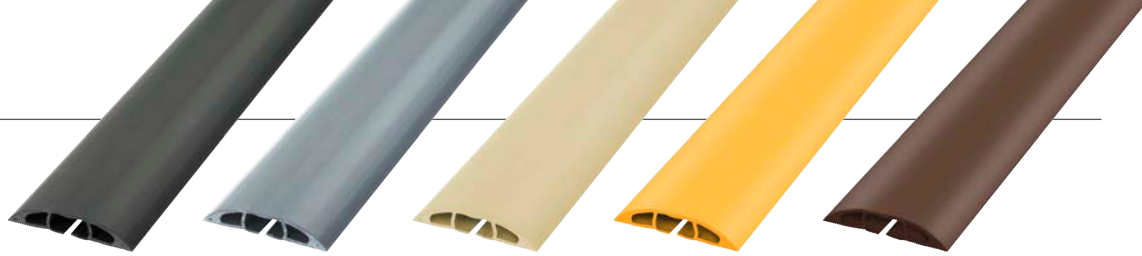
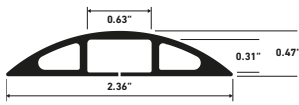

- Ideal for areas with light foot traffic
- Address a common cause of trips, tugs and falls
- Can protect up to 2x 0.31" diameter cables
- Ribbed non-slip base, pre-split rear for ease of use
- Flexible PVC - Supplied coiled in box; simply uncoil to lay flat

Part No.	Description
CC-1	6' length Black Floor Cable Cover - Cavity 1.2" x 0.39"
US/CC-2	6' length Brown Floor Cable Cover - Cavity 1.2" x 0.39"
US/CC-3	6' length Beige Floor Cable Cover - Cavity 1.2" x 0.39"
US/CC-4	6' length Gray Floor Cable Cover - Cavity 1.2" x 0.39"
US/CC-6	6' length Safety Yellow Floor Cable Cover - Cavity 1.2" x 0.39"

## Cable Organizer Boxes



- Contribute to a positive Health & Safety culture in offices
- Tidy, route & sort unsightly cable clutter
- Make surfaces easier to clean
- Make power strips less accessible
- Prevent feet snagging cables under desks - save entanglements and costly disconnections
- Produced using electrically-safe ABS material

**Power strips not included**

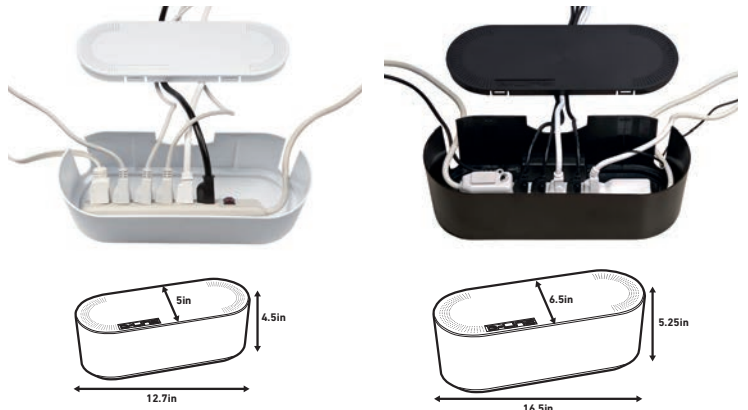

Part No.	Description
US/COBSMLW	Small White Cable Organizer Box
US/COBSMLB	Small Black Cable Organizer Box
US/COBLGEW	Large White Cable Organizer Box
US/COBLGEB	Large Black Cable Organizer Box

## Cable Zipper

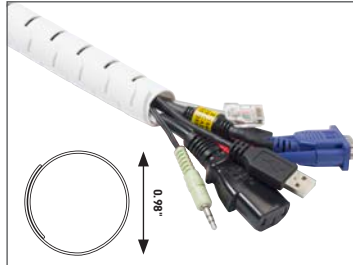
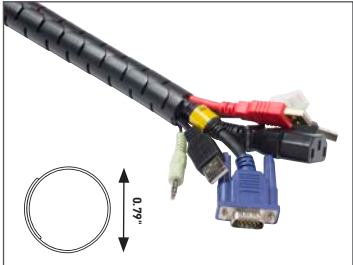

- Ideal to conceal & protect longer runs of cables
- Quick and easy to use - scissor cut to length; insert cables in zip tool; put zip tool in to length; pull zip tool along length
- Flexible design and good resistance to oils/lubricants, acids & alkalis - suitable for use around plant and machinery too
- Zip tool included in pack
- Operating temperature -22°F to +185°F

Part No.	Description
US/CZ252.5B	Cable Zipper - Black
US/CZ252.5W	Cable Zipper - White

## Split Cable Tube

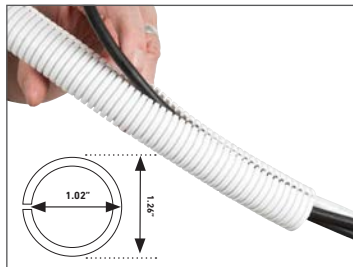
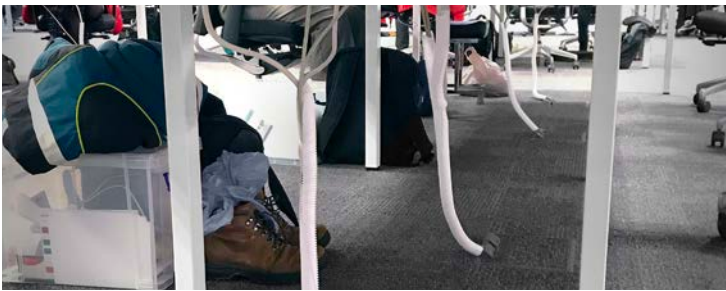

- Tidy & protect several cables
- Ideal to contain cables dropping behind TVs and desks
- Pre-split - fits around existing cables
- Flexible & easiest to add or remove cables
- No application tool needed
- Supplied 3'7" lengths

Part No.	Description
US/CTT1.1B	1.2" Cable Split Tube, 3'7" Length - Black
US/CTT1.1/25B	1" Cable Split Tube, 3'7" Length - Black
US/CTT1.1W	1.2" Cable Split Tube, 3'7" Length - White

## Cable Spiral Wrap

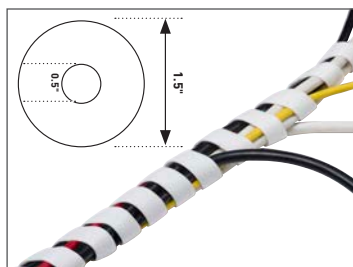
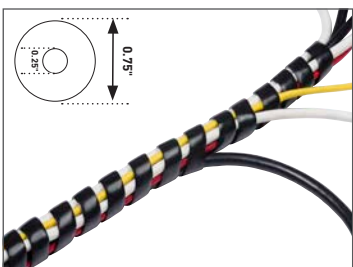

- Versatile, easy to exit cables at any point along length
- Ideal for shorter runs of cable
- 0.06" gauge LDPE material protects cable insulation
- Expands around bundles of cables up to 1.57" diameter
- Good resistance to oils/lubricants, acids & alkalis
- Easy to cut to required length, then wrap by hand

Part No.	Description
US/CTW2.5W	Cable Spiral Wrap, 0.39" - 0.55" dia x 8.2' length - White
US/CTW2.5B	Cable Spiral Wrap, 0.39" - 0.55" dia x 8.2' length - Black





**D-Line (USA) Inc**

**2671 Technology Drive, Suite 112, Louisville, KY40299**

**Tel:** 1-800-901-4396 **Email:** salesusa@d-line-it.com **Web:** www.d-line.com