

RANGEMASTER[®]

WIRE FENCE EXPERTS

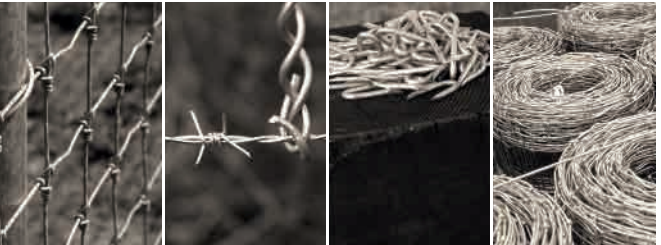

Field Fence / Barbed Wire / Barbless Wire / Horse Fence / Tie Wire
Chain Link / StayLock Fence / Electric Fence / Sheep & Goat Fence
Staples / 8 # Bucket Barbed and Knurled Staples / Panels / Hog Floor
Galvanized Wire / Poultry Netting / Hardware Cloth / Fence Stays



Pocket Brochure

RANGEMASTER®

WIRE FENCE EXPERTS

Rangemaster is our premium farm & ranch fencing product line on Field Fence, Barbed Wire, Horse Fence, Sheep & Goat Fence, Fixed Knot, Chain Link, Electric Fence Wire, Welded Mesh and many more. Ours is one of the broadest product lines in the market.

Our focus is supplying quality products reliably, efficiently and safely.

Rangemaster is backed by Deacero, a large steel manufacturer committed to a strategy of sustainable growth that benefits the company, the environment, our employees and the communities in which we operate. It possesses its own advanced technology for recycling steel scrap and converting it into steel products.

This contributes to Rangemaster continuing success in meeting our rapidly expanding customer demands.

The Deacero logo features the word "DEACERO" in a bold, white, sans-serif font. A stylized orange and white graphic element resembling a flame or a drop is positioned below the letter 'A'. The logo is set against a dark, rounded rectangular background.

deacero.com



INDEX

Acreage Guide	2
Acreage Chart	3
Chain Link Non Compact	4
EZ Roll Chain Link	6
Poultry Netting	8
Multipurpose Netting	10
Field Fence	12
High Tensile Field Fence	16
Welded Utility Fence	18
Horse Fence	20
Sheep & Goat Fence	22
Tie Wire	24
Galvanized Crimp Wire	25
Barbed Wire	26
High Tensile Barbed Wire	28
Barbless Wire	30
Fence Stays	32
Electric Fence	34
Panels	36
Hog Floor	38
Hardware Cloth	40
Staples	42
8 # Bucket Barbed and Knurled Staples	44
Galvanized Wire	46
Smooth Galvanized Wire	48
Baler Wire	50
StayLock Fence	52

ACREAGE GUIDE

Use this diagram to calculate the number of rods of fence required to enclose fields of different sizes.

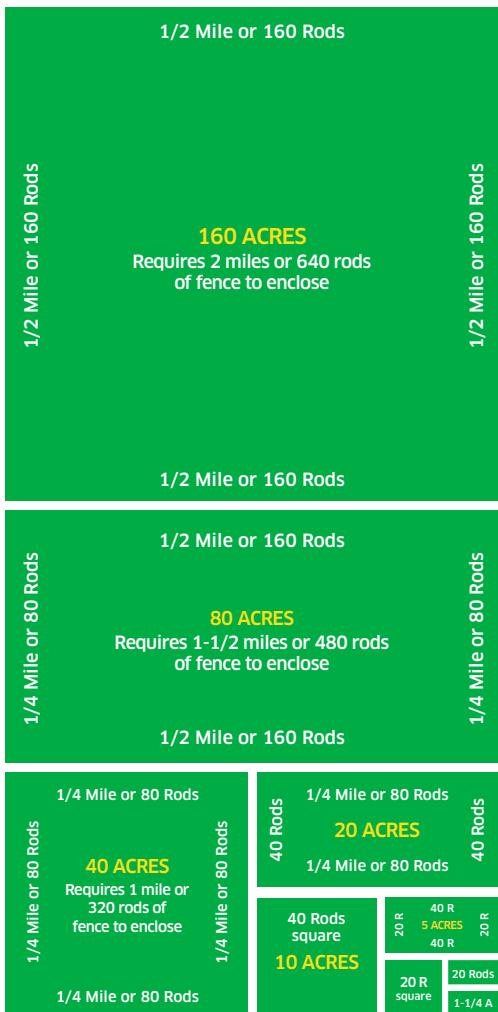

ACREAGE CHART

Recommendations.

Assumes square area to be fenced. The quantity of fence required will increase as the area gets narrower and longer.

Acres	Fence 20 Rod Rolls	Fence 100 ft. Rolls	Barbed Wire 80 Rod Rolls 1 Strand	Acres	Fence 20 Rod Rolls	Fence 100 ft. Rolls	Barbed Wire 80 Rod Rolls 1 Strand
1	3	9	1	65	21	68	6
2	4	12	1	70	22	70	6
3	5	15	1	75	22	73	6
4	5	17	2	80	23	75	6
5	6	19	2	85	24	77	6
6	7	21	2	90	24	80	6
7	7	22	2	95	25	82	7
8	8	24	2	100	26	84	7
9	8	25	2	105	26	86	7
10	8	26	2	110	27	88	7
11	8	28	3	115	28	90	7
12	9	29	3	120	28	92	7
13	10	31	3	125	28	94	7
14	10	31	3	150	31	103	8
15	10	33	3	175	34	111	8
16	11	34	3	200	36	118	9
17	11	35	3	225	38	126	10
18	11	36	3	250	40	132	10
19	11	37	3	275	42	139	11
20	12	38	3	300	44	145	11
25	13	42	4	325	46	151	12
30	14	46	4	350	48	157	12
35	15	50	4	375	49	162	13
40	16	53	4	400	51	167	13
45	17	56	5	425	53	173	13
50	18	60	5	450	54	177	14
55	19	62	5	475	56	182	14
60	20	65	5				

CHAIN LINK NON COMPACT

Uses:

- Dividing side yard or property.
- Warehouse or industrial areas fencing.
- Security areas fencing.
- Residential fencing.
- Parks and playgrounds fencing.
- Gates and dog kennels.

Features:

- Non compacted roll.
- Uniformly zinc coated.
- Knuckle - knuckle or knuckle-twist top mesh finishing.
- UPC Coded.

Advantages:

- Price competitive.
- Easy to install.
- Corrosion resistant.
- Meets ASTM-A-641.
- Meets ASTM-A-392.



Chain Link Non Compact Class 1

Deacero Part No.	Design	Gauge	Height	Length	Rolls per Pallet
			(")	(')	
5107	2 1/4" KNUCKLE TWIST	11.5	72	50	9

Chain Link Non Compact Class 3

Deacero Part No.	Design	Gauge	Height	Length	Rolls per Pallet
			(")	(')	
5029	2 1/4" KNUCKLE KNUCKLE	12.5	43.5	50	20
5030	2 1/4" KNUCKLE KNUCKLE	12.5	55.5	50	20
5031	2 1/4" KNUCKLE KNUCKLE	12.5	67.5	50	20
5034	2 1/4" KNUCKLE KNUCKLE	12.5	46	60	20
5035	2 1/4" KNUCKLE KNUCKLE	12.5	70	60	20
5219	2 3/8" KNUCKLE KNUCKLE	11.5	42	50	9
5220	2 3/8" KNUCKLE KNUCKLE	11.5	48	50	9
5221	2 3/8" KNUCKLE KNUCKLE	11.5	60	50	9
5222	2 3/8" KNUCKLE KNUCKLE	11.5	72	50	9
5223	2 3/8" KNUCKLE TWIST	11.5	72	50	9
5248	2 3/8" KNUCKLE KNUCKLE	12.5	48	50	9
5249	2 3/8" KNUCKLE KNUCKLE	12.5	60	50	9
5250	2 3/8" KNUCKLE KNUCKLE	12.5	72	50	9
5251	2 3/8" KNUCKLE TWIST	12.5	72	50	9

Chain Link Non Compact Class 4

Deacero Part No.	Design	Gauge	Height	Length	Rolls per Pallet
			(")	(')	
5232	2" KNUCKLE KNUCKLE	9	48	50	6
5234	2" KNUCKLE KNUCKLE	9	72	50	6
5235	2" KNUCKLE TWIST	9	72	50	6



EZ ROLL CHAIN LINK

Uses:

- Dividing side yard or property.
- Warehouse or industrial areas fencing.
- Security areas fencing.
- Residential fencing.
- Parks and playgrounds fencing.
- Gates and dog kennels.

Features:

- Compacted roll.
- Uniformly zinc coated.
- Knuckle - knuckle or knuckle-twist top mesh finishing.
- UPC Coded.

Advantages:

- Easy to handle and store.
- Price competitive.
- Easy to install.
- Corrosion resistant.
- Meets ASTM-A-641.



EZ Roll Chain Link Class 3

Deacero Part No.	Design	Gauge	Height	Length	Rolls per Pallet
			(")	(')	
10640	2 3/8" KNUCKLE KNUCKLE	11.5	42	50	20
10641	2 3/8" KNUCKLE KNUCKLE	11.5	48	50	20
10642	2 3/8" KNUCKLE KNUCKLE	11.5	60	50	20
10643	2 3/8" KNUCKLE KNUCKLE	11.5	72	50	20
10644	2 3/8" KNUCKLE TWIST	11.5	72	50	30
10657	2 3/8" KNUCKLE KNUCKLE	12.5	36	50	20
10658	2 3/8" KNUCKLE KNUCKLE	12.5	42	50	20
10659	2 3/8" KNUCKLE KNUCKLE	12.5	48	50	20
10660	2 3/8" KNUCKLE KNUCKLE	12.5	60	50	20
10661	2 3/8" KNUCKLE KNUCKLE	12.5	72	50	30
10662	2 3/8" KNUCKLE TWIST	12.5	72	50	30

* EZ Roll Chain Link comes with a plastic edge guard that makes storage simpler.

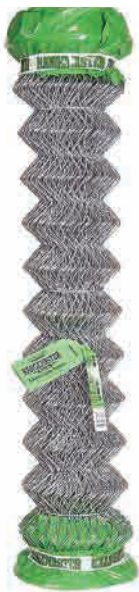

POULTRY NETTING

Uses:

- Poultry and small animals fencing.
- Lawn & garden fencing.
- Insulation retainers.
- Storage bins.
- Stone wrapping.

Features:

- Reinforced wire lines.
- Even spacing across the net.
- Galvanized before weaving.
- UPC Coded.

Advantages:

- Remains perfectly straight and flat.
- Adaptable for all fencing needs.
- Long lasting.
- Meets ASTM-A-390.

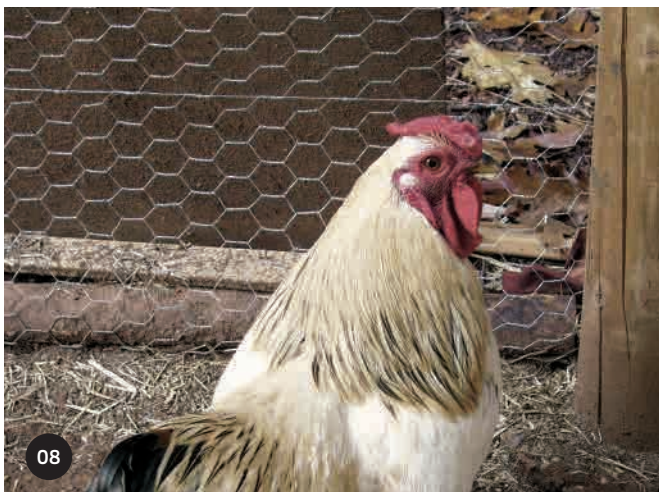

Poultry Netting 1'

Deacero Part No.	Mesh Spacing	Gauge	Height	Length	Rolls per Pallet
	(")		(")	(')	
5924	1	20	12	150	96
5925	1	20	18	150	72
5926	1	20	24	150	48
5927	1	20	36	150	24
5928	1	20	48	150	24
5929	1	20	60	150	24
5930	1	20	72	150	24
5931	1	20	12	50	118
5932	1	20	18	50	118
5934	1	20	24	50	118
5936	1	20	36	50	59
5937	1	20	48	50	59
5938	1	20	60	50	59
5939	1	20	72	50	59

Poultry Netting 2'

Deacero Part No.	Mesh Spacing	Gauge	Height	Length	Rolls per Pallet
	(")		(")	(')	
6001	2	20	24	150	48
6002	2	20	36	150	24
6003	2	20	48	150	24
6004	2	20	60	150	24
6005	2	20	72	150	24
6025	2	20	24	50	166
6026	2	20	36	50	83
6027	2	20	48	50	83
6028	2	20	60	50	83
6029	2	20	72	50	83



MULTIPURPOSE NETTING

Uses:

- Poultry and small animals fencing.
- Lawn & garden fencing.
- Insulation retainers.
- Storage bins.
- Stone wrapping.

Features:

- Reinforced wire lines.
- Even spacing across the net.
- Galvanized before weaving.
- UPC Coded.

Advantages:

- Remains perfectly straight and flat.
- Adaptable for all fencing needs.
- Long lasting.
- Meets ASTM-A-390.



Multipurpose Netting 1'

Deacero Part No.	Mesh Spacing	Gauge	Height	Length	Rolls per Pallet
	(')		(")	(')	
5973	1	20	24	25	144
5974	1	20	36	25	72
5975	1	20	48	25	72

Multipurpose Netting 2'

Deacero Part No.	Mesh Spacing	Gauge	Height	Length	Rolls per Pallet
	(')		(")	(')	
6037	2	20	24	25	144
6038	2	20	36	25	72
6039	2	20	48	25	72



FIELD FENCE

Uses:

- Livestock fencing and confinement.
- Crop protection.
- Erosion control silt fence backing.
- Land fencing and boundary dividers.

Features:

- Hinge joint knot.
- Wire tension curve.
- Extra strong top and bottom wire lines.
- UPC Coded.

Advantages:

- Small bottom mesh spacing to keep small wild animals out.
- Wide upper mesh spacing to keep big wild animals away and livestock.
- Easy to install on different kind of surface and terrain.
- Corrosion resistant.
- Resistant to cattle impacts.
- Weather resistant.
- Meets ASTM-A-116.



Field Fence Commercial Class

Deacero Part No.	Design	Filler Gauge	Top / Bottom Gauge	Fence Height	Roll Length	Rolls per Pallet	Spacing Vertical Wires
				(")	(')		
6748	2158/6 14.5 10R	14.5	11	50	165	9	6
6749	2571/6 14.5 10R	14.5	11	50	165	9	6
6702	832/6 14.5 20R	14.5	11	50	330	9	6
6703	939/6 14.5 20R	14.5	11	60	330	9	6
6704	1047/6 14.5 20R	14.5	11	60	330	9	6
6667	832/6 12.5 20R	12.5	10	50	330	9	6
6668	939/6 12.5 20R	12.75	10	50	330	9	6
6670	1047/6 12.5 20R	12.75	10	50	330	9	6
6673	832/12 12.5 20R	12.5	10	50	330	9	12
6674	939/12 12.5 20R	12.5	10	50	330	9	12
6676	1047/12 12.5 20R	12.5	10	50	330	9	12
6774	632/12 12.5 20R	12.5	10	50	330	9	12
6977	939/12 14.5 330FT	14.5	11	50	330	16	12
6976	532/12 16 330FT	16	14	50	330	16	12

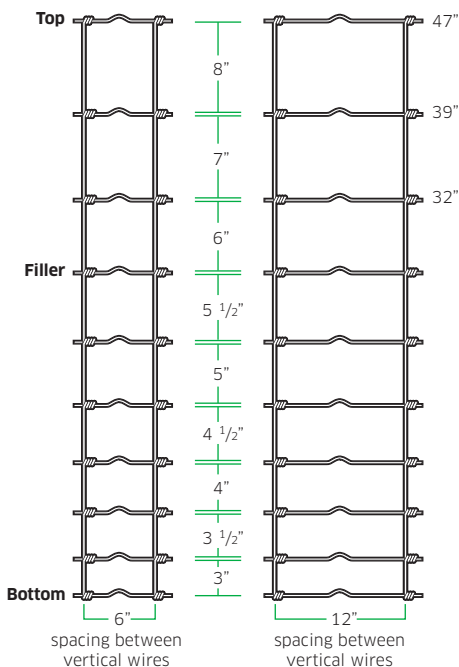

FIELD FENCE

HOW TO READ A RANGEMASTER FIELD FENCE MESH DESIGN

Use the following example to decode a Rangemaster field fence mesh design.

Number of horizontal lines

Filler wires gauge



Mesh height in inches

Spacing across vertical wires in inches



Field Fence Class 1

Deacero Part No.	Design	Filler Gauge	Top / Bottom Gauge	Fence Height	Roll Length	Rolls per Pallet	Spacing Vertical Wires
				(")	(')		
6717	1035/6 14.5 20R	14.5	11	35	330	9	6
6718	1035/12 14.5 20R	14.5	11	35	330	9	12
6693	832/6 14.5 20R	14.5	11	32	330	9	6
6694	939/6 14.5 20R	14.5	11	39	330	9	6
6695	1047/6 14.5 20R	14.5	11	47	330	9	6
6615	832/6 11.0 20R	11	9	32	330	8	6
6616	939/6 11.0 20R	11	9	39	330	8	6
6617	1047/6 11.0 20R	11	9	47	330	8	6
6621	1047/12 11.0 20R	11	9	47	330	9	12
6654	832/6 12.5 20R	12.5	10	32	330	9	6
6655	939/6 12.5 20R	12.5	10	39	330	9	6
6656	1047/6 12.5 20R	12.5	10	47	330	9	6
6659	939/12 12.5 20R	12.5	10	39	330	9	12
6660	1047/12 12.5 20R	12.5	10	47	330	9	12

Field Fence Class 3

Deacero Part No.	Design	Filler Gauge	Top / Bottom Gauge	Fence Height	Roll Length	Rolls per Pallet	Spacing Vertical Wires
				(")	(')		
6625	1047/6	11	9	47	330	8	6
6623	832/6	11	9	32	330	8	6



Hinge Joint Knot



HIGH TENSILE FIELD FENCE

Uses:

- Livestock fencing and confinement.
- Crop protection.
- Erosion control silt fence backing.
- Land fencing and boundary dividers.

Features:

- Extra zinc coated.
- Heavy duty galvanized.
- Hinge joint knot.
- Wire tension curve.
- Extra strong top and bottom wire lines.
- UPC Coded.

Advantages:

- Extremely weather resistant.
- Long lasting.
- Small bottom mesh spacing to keep small wild animals out.
- Wide upper spacing to keep large wild animals away and livestock confined.
- Easy to install on different kind of surfaces and terrain.
- Corrosion resistant.
- Resistant to cattle impact.
- Meets ASTM-A-116.



High Tensile Field Fence Class 3

Deacero Part No.	Design	Filler Gauge	Top / Bottom Gauge	Fence Height	Roll Length	Rolls per Pallet	Spacing Vertical Wires
				(")	(')		
6757	939/6	12.5	10.5	39	330	9	6
6758	1047/6	12.5	10.5	47	330	9	6
6771	832/6	14.5	12.5	32	330	9	6
6772	939/6	14.5	12.5	39	330	9	6
6773	1047/6	14.5	12.5	47	330	9	6
6762	1047/12	12.5	10.5	47	330	9	12
6756	832/6	12.5	10.5	32	330	9	6
6753	1596/6	12.5	12.5	96	330	6	6
6782	1478/6	12.5	12.5	78	330	9	6



Hinge Joint Knot



WELDED UTILITY FENCE

Uses:

- Lawn and garden fencing.
- Pet and small animal fencing.
- Animal cages.
- Tree and flower guard.
- Trash and mulch holders.
- Do it yourself (DIY) projects.
- Tops of greenhouse benches.

Features:

- Galvanized before welding.
- Smooth and uniform mesh edges.
- Welded cross wires.
- UPC Coded.

Advantages:

- Adaptable for all fencing needs.
- Corrosion resistant.
- Easy to handle and carry.
- Easy to install.
- Price competitive.
- Meets ASTM-A-641.



Welded Utility Fence

Deacero Part No.	Mesh Spacing	Gauge	Fence Height	Roll Length	Rolls per Pallet
	(")		(")	(')	
7721	2X4	12.5	24	100	18
7722	2X4	12.5	36	100	18
7723	2X4	12.5	48	100	9
7724	2X4	12.5	60	100	9
7725	2X4	12.5	72	100	9
7732	2X4	12.5	36	50	32
7733	2X4	12.5	48	50	16
7734	2X4	12.5	60	50	16
7735	2X4	12.5	72	50	16
7741	2X4	14	24	100	18
7742	2X4	14	36	100	18
7743	2X4	14	48	100	9
7744	2X4	14	60	100	9
7745	2X4	14	72	100	9
7752	2X4	14	36	50	32
7753	2X4	14	48	50	16
7754	2X4	14	60	50	16
7755	2X4	14	72	50	16



HORSE FENCE

Uses:

- Horse fencing.
- Horse paddock boundary and interior protection.

Features:

- Stiff-Stay knot.
- Pre-stripped roll (all Rangemaster Horse Fence rolls comes with 18" of vertical stays removed from both ends of the roll).
- Wire tension curve.
- Uniformly zinc coated.

Advantages:

- Mesh spacing prevents horses from stepping through the fence.
- Resistant to horse impacts.
- Keeps the same shape after intense hitting by horses.
- Long lasting.
- Meets ASTM-A-641.



Horse Fence Class 1

Deacero Part No.	Filler Gauge	Top/Bottom Gauge	Mesh Spacing	Fence Height	Roll Length	Roll Weight	Rolls per Pallet
			(")	(")	(')		
6793	12.5	10	2x4	60	100	143	9
6794	12.5	10	2x4	72	100	170	9
6795	12.5	10	2x4	48	100	116	9
6955	12.5	10	2x4	48	200	232	4
6956	12.5	10	2x4	60	200	286	4
6957	12.5	10	2x4	72	200	340	4
7031	12.5	10	2x4	48	50	58	9

Horse Fence Class 3

Deacero Part No.	Filler Gauge	Top/Bottom Gauge	Mesh Spacing	Fence Height	Roll Length	Roll Weight	Rolls per Pallet
			(")	(")	(')		
6958	12.5	10	2x4	48	200	231	4
6959	12.5	10	2x4	60	200	286	4
6960	12.5	10	2x4	72	200	240	4
6962	12.5	10	2x4	48	100	116	9
6963	12.5	10	2x4	60	100	143	9

High Tensile Horse Fence Class 3

Deacero Part No.	Filler Gauge	Top/Bottom Gauge	Mesh Spacing	Fence Height	Roll Length	Roll Weight	Rolls per Pallet
			(")	(")	(')		
7021	12.5	12.5	2x4	60	200	280	4
7022	12.5	12.5	2x4	48	100	113	9
7023	12.5	12.5	2x4	48	200	225	4
7024	12.5	12.5	2x4	72	100	167	9
6996	12.5	12.5	2x4	60	100	140	9

Horse Fence Zinc Aluminum + Black Paint

Deacero Part No.	Filler Gauge	Top/Bottom Gauge	Mesh Spacing	Fence Height	Roll Length	Roll Weight	Rolls per Pallet
			(")	(")	(')		
7781	12.5	12.5	2x4	48	100	113	9
7784	12.5	12.5	2x4	48	200	225	4
7785	12.5	12.5	2x4	60	100	140	9
7786	12.5	12.5	2x4	60	200	280	4
7787	12.5	12.5	2x4	72	100	167	9



Stiff-Stay Knot



SHEEP & GOAT FENCE

Uses:

- Boundary and interior fencing for sheep and goats.

Features:

- Stiff-Stay knot.
- Pre-stripped roll (all Rangemaster Horse Fence rolls comes with 18" of vertical stays removed from both ends of the roll).
- Wire tension curve.
- Uniformly zinc coated.

Advantages:

- Prevents wild animals and predators from entering the farm and attack the sheep.
- Confines small sheep and stubborn goats.
- Does not harm sheep and goats during impact.
- Mesh spacing prevents sheep and goat from stepping through the fence.
- Easy to install on any kind of surface or terrain.
- Long lasting.
- Meets ASTM-A-641.



Sheep & Goat Fence Class 1

Deacero Part No.	Filler Gauge	Top/Bottom Gauge	Mesh Spacing	Fence Height	Roll Length	Roll Weight	Rolls per Pallet
			(")	(")	(')		
6964	13	12.5	4X4	48	100	76	9
6965	13	12.5	4X4	48	330	251	4

Sheep & Goat Fence Class 3

Deacero Part No.	Filler Gauge	Top/Bottom Gauge	Mesh Spacing	Fence Height	Roll Length	Roll Weight	Rolls per Pallet
			(")	(")	(')		
6966	12.5	10	4X4	48	100	76	9
6967	12.5	10	4X4	48	330	251	4

High Tensile Sheep & Goat Fence Class 3

Deacero Part No.	Filler Gauge	Top/Bottom Gauge	Mesh Spacing	Fence Height	Roll Length	Roll Weight	Rolls per Pallet
			(")	(")	(')		
6997	12.5	12.5	4X4	48	330	240	4
6998	12.5	12.5	4X4	48	100	73	9
7020	12.5	10	4X4	48	330	251	4

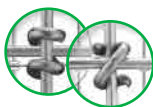

Stiff-Stay Knot



TIE WIRE

Uses:

- Tie rod holding.

Features:

- Black Annealed.

Advantages:

- Strong and secure.
- Meets ASTM-A-853.

Tie Wire

Deacero Part No.	Gauge	Length Approx	Weight	Rolls per Box	Boxes per Pallet
		(')			
5689	16.5	330	65	20	48



GALVANIZED CRIMP WIRE

Uses:

- An excellent choice to reinforce the top & bottom of your Chain Link.

Features:

- Class III galvanized wire.

Advantages:

- Meets ASTM-A-824.

Galvanized Crimp Wire Class 3

Deacero Part No.	Gauge	Coil Weight	Coil Length	Units per Pallet
			(')	
5502	7	79	1000	16
5504	7	100	1238	16



BARBED WIRE

Uses:

- Cattle and livestock fencing.
- Land fencing and protection.
- Crop protection.
- Home security fencing aid.

Features:

- **COMMERCIAL CLASS**
- Uniformly zinc coated.
- Galvanized wires.
- Barbs fixed between wires.
- UPC Coded.

- **CLASS 1**

- Extra and uniformly zinc coated.
- Galvanized wires.
- UPC Coded.

- **CLASS 3**

- Extra and uniformly zinc coated.
- Heavy duty galvanized.
- UPC Coded.

Advantages:

- Resistant to cattle impact.
- Easy to install on any surface.
- Fence lasts as any other traditional Barbed Wire.

- Fence lasts longer than any other traditional Barbed Wire.
- Resistant to cattle impact.
- Meets ASTM-A-121 Class 1.

- Fence lasts 3 times more than Commercial Barbed Wire.
- Extremely weather resistant.
- Meets ASTM-A-121 Class 3.



Barbed Wire Commercial Class

Deacero Part No.	Gauge	Barb Style	Barb Spacing	Length	Rolls per Pallet
			(")	(')	
7125	12.75	2 PTS	5	1320	27
7126	12.75	4 PTS	5	1320	27
7136	12.5	2 PTS	5	1320	27

Barbed Wire Class 1

Deacero Part No.	Gauge	Barb Style	Barb Spacing	Length	Rolls per Pallet
			(")	(')	
7112	12.5	2 PTS	4	1320	27
7114	12.5	2 PTS	5	1320	27
7115	12.5	4 PTS	5	1320	27

Barbed Wire Class 3

Deacero Part No.	Gauge	Barb Style	Barb Spacing	Length	Rolls per Pallet
			(")	(')	
7104	12.5	4 PTS	5	1320	27



HIGH TENSILE BARBED WIRE

Uses:

- Cattle and livestock fencing.
- Land fencing and protection.
- Crop protection.
- Home and business security fencing aid.

Features:

- Extra and uniformly zinc coated.
- Heavy duty galvanized.
- Extra sharp barbs.
- Class 3 zinc coated.
- No stretching required when installing.
- Barbs fixed between wires.
- UPC Coded.

Advantages:

- Fence lasts 3 times longer than Commercial Barbed Wire.
- Extremely weather resistant.
- Needs less labor, time, posts and money to install.
- Easy to carry and store.
- Easy to install on any kind of surface.
- Resistant to cattle impact.
- Adaptable for all fencing needs.
- Wrapped around for extra protection when carrying.
- Meets ASTM-A-121 Class 3.



High Tensile Barbed Wire Class 3

Deacero Part No.	Gauge	Barb Style	Barb Spacing	Length	Rolls per Pallet
			(")	(')	
7202	15.5	2 PTS	5	1320	48
7203	15.5	4 PTS	5	1320	48
7223	14	4 PTS	5	1320	27
7225	14	2 PTS	5	1320	27

WHAT IS CLASS 3 ZINC COATING?

Read carefully the following diagram to understand the ranking value of the different zinc coating classes on Rangemaster products.

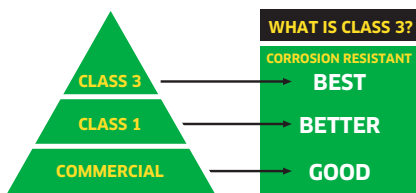

BARBLESS WIRE

Uses:

- Cattle and livestock fencing.
- Land fencing and protection.
- Crop protection.

Features:

- Uniformly zinc coated.
- Heavy duty galvanized wires.
- 13 Horizontal wires.
- UPC Coded.

Advantages:

- Easy to install on any kind of surface.
- Adaptable for all fencing needs.
- Resistant to cattle impact.
- Easy to carry and store.
- Meets ASTM-A-641.



Barbless Wire Commercial Class

Deacero Part No.	Gauge	Length	Rolls per Pallet
(')			
7227	12.5	1320	27
7233	14.5	1320	40

Barbless Wire Class 1

Deacero Part No.	Gauge	Length	Rolls per Pallet
(')			
7228	12.5	1320	32



FENCE STAYS

Uses:

- Barbed wire fencing support.

Features:

- Galvanized.
- For different fence heights.

Advantages:

- Saves money on installation by using fewer posts.
- Keep fence shape and barbed wire spacing.
- Extra fence resistance and security.
- Meets ASTM-A-641.



Fence Stays

Deacero Part No.	Gauge	Height	Pieces per Bundle	Bundles per Pallet
(")				
7262	10	36	100	50
7263	10	42	100	50
7264	10	48	100	50



ELECTRIC FENCE

Uses:

- Rotational grazing fencing.
- Electrified boundary and interior fencing.
- Temporary land fencing.

Features:

- High tensile.
- Heavy duty galvanized.
- Breaking strength of 170 to 200 ksi.
- Triple zinc coated.
- UPC Coded.

Advantages:

- Extra strength.
- Long lasting.
- Saves 77% on posts.
- Added electric conductivity.
- Corrosion and rust resistant.
- Easy to unroll and install.
- Meets ASTM 845.
- Meets ASTM-A-641.



Electric Fence Wire Class 3

Deacero Part No.	Gauge	Steel Grade	Wire Diameter	Weight	Length	Rolls Diam. Approx.	Rolls per Pallet
			(")		(')	(')	
5655	12.5	1018	0.0956	66	2640	1.97	20
5658	12.5	1018	0.0956	100	4000	1.97	20
5663	12.5	1065	0.0956	100	4000	1.97	20

Electric Fence Wire Spools

Deacero Part No.	Gauge	Mile Length	Spools per Box	Approx. Weight per Box	Boxes per Pallet
5771	14	1/4	2	46	36
5772	14	1/2	1	46	36
5773	17	1/4	4	43	36
5774	17	1/2	2	42	36



PANELS

Uses:

- Cattle and livestock confinement.
- Temporary farm and paddock fencing.
- Alley fencing.
- Paddock ventilation.

Features:

- Welding strength of 220 lbs.
- Breaking strength of 170 to 200 ksi.
- Uniformly zinc coated.
- UPC Coded.

Advantages:

- Resistant to cattle impacts.
- Price competitive.
- Adaptable to other panel sizes, surfaces and terrains.
- Easy to install.
- Long lasting.
- Paddock ventilation.
- Meets ASTM-A-641.



Panels

Deacero Part No.	Panel Style	Gauge	Length	Height	Opening	Horiz. Wires	Weight per Panel	Panels per Pallet
			(')	(")	(')			
9409	FENCE	4	16	48	4X4	13	50	50
9429	HOG	4	16	34	*GX8	11	31	50
9449	CATTLE	4	16	50	*GX8	10	33	50
9452	CATTLE	4	16	50	*GX8	10	31	50
80897	COMBINATION	4	16	52	*GX8	13	40	50
80899	FENCE	4	20	48	4X4	13	63	50
80900	FENCE	4	16	60	4X4	16	63	50
80901	FENCE	4	20	60	4X4	16	78	50
80902	FENCE	6	20	60	4X4	16	56	50
80903	FENCE	6	20	72	4X4	19	67	50
80905	FENCE	4	20	60	6X6	11	53	50
80906	FENCE	6	20	60	6X6	11	38	50
80907	FENCE	6	20	36	4X4	10	35	50
80908	FENCE	6	16	48	4X4	13	37	50
80909	FENCE	6	20	48	4X4	13	46	50
80910	FENCE	6	20	96	4X4	25	89	25
80915	HORSE	6	12	48	4X2	13	41	50
80917	HORSE	6	20	48	4X2	13	67	25
80918	HORSE	6	12	60	4X2	16	50	50
80919	HORSE	6	16	60	4X2	16	67	50
80920	HORSE	6	20	60	4X2	16	84	25
80921	HORSE	6	20	72	4X2	19	100	25

* G - Stands for the graduation.

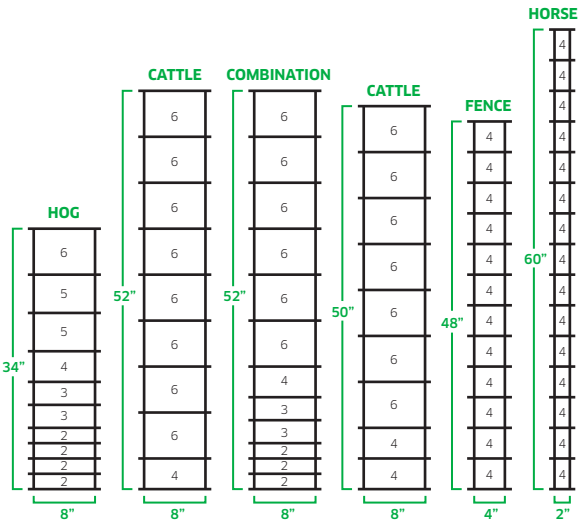

HOG FLOOR

Uses:

- Excellent for hog farms or industrial walkways.

Features:

- Long lasting.
- Easy to install.
- Easy to clean and maintain.
- Easy for livestock to walk on - best traction wet or dry.

Advantages:

- It has excelled demanding conditions under water, feed and weight.
- It is a dry, comfortable and clean surface.
- Have a bacteria free environment with the best traction and footing.
- The patented "double smooth" design provides excellent traction, while skid-free footing means fewer injuries and easy clean up.
- Available in 5/6" and 3" gauge sizes.



Hog Floor

Design Wire	Gauge
(")	
3/8 x 3	5/16
3/8 x 1 1/2	3

* Panel sizes are custom made to fit your needs.

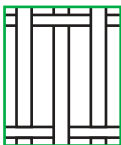

Design: **3/8 x 3"**
Gauge wire: **5/16**

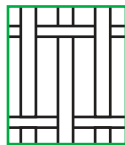

Design: **3/8 x 1 1/2"**
Gauge wire: **3**

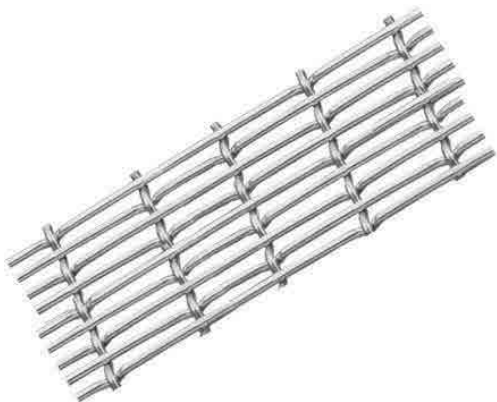

HARDWARE CLOTH

Uses:

- Pets and small animal cages.
- Tree and plant guards.
- Bird feeders.
- Garden fencing.
- Kick panels on screen doors.
- Loam and sand screening.
- Windows and skylights protection.

Features:

- Heavy duty galvanized.
- Premium galvanized smooth wire lines.
- Reinforced top and bottom wire lines.
- Galvanized after weaving.
- Extra zinc coated.
- UPC Coded.

Advantages:

- Corrosion resistant.
- Strong and durable.
- Adaptable for all fencing needs.
- Long lasting.
- Extra-strength wire.



Hardware Cloth

Deacero Part No.	Mesh Spacing	Gauge	Height	Length	Rolls per Pallet
	(")		(")	(')	
7813	2X2	19	36	100	16
7828	2X2	23	36	5	144
7829	4X4	23	36	5	90



STAPLES

Styles:

- Galvanized barbed.
- Galvanized smooth.
- Galvanized knurled.
- Galvanized netting.
- Bright smooth.
- Bright knurled.

Uses:

- Support farm fencing on wood posts and bars.

Features:

- Black or heavy duty galvanized.
- Smooth, barbed, lock or netting staple finish.
- Extra sharp and with holding points.
- U and V staple designs.

Advantages:

- Extra holding power on wood posts.
- U staple design do not scratch on wire coating.
- Multipurpose.
- Meets FF-N-105B.



Galvanized Barbed Staples



Deacero Part No.	Gauge	Length	Package (Pounds per Box)	Boxes per Pallet
(")				
7476	8	1 1/2	50	48
7475	8	1 3/4	50	48
7477	8	2	50	48
7478	8	1 1/4	50	48

Galvanized Smooth Staples



Deacero Part No.	Gauge	Length	Package (Pounds per Box)	Boxes per Pallet
(")				
7412	9	1	50	48
7414	9	1 1/4	50	48
7415	9	1 1/2	50	48
7416	9	1 3/4	50	48

Galvanized Knurled Staples



Deacero Part No.	Gauge	Length	Package (Pounds per Box)	Boxes per Pallet
(")				
7401	9	1	50	48
7402	9	1 1/8	50	48
7403	9	1 1/4	50	48
7404	9	1 1/2	50	48
7405	9	1 3/4	50	48
7406	9	2	50	48

Galvanized Netting Staples



Deacero Part No.	Gauge	Length	Package (Pounds per Box)	Boxes per Pallet
(")				
7423	14	3/4	50	48

Bright Smooth Staples



Deacero Part No.	Gauge	Length	Package (Pounds per Box)	Boxes per Pallet
(")				
7441	9	1 1/4	50	48
7442	9	1 1/2	50	48
7443	9	1 3/4	50	48

Bright Knurled Staples



Deacero Part No.	Gauge	Length	Package (Pounds per Box)	Boxes per Pallet
(")				
7429	9	1	50	48
7430	9	1 1/4	50	48
7431	9	1 1/2	50	48
7432	9	1 3/4	50	48

8 # BUCKET BARBED AND KNURLED STAPLES

Styles:

- Galvanized knurled .
- Galvanized barbed.

Uses:

- Supports farm fencing on wood posts and bars.

Features:

- Plastic bucket.
- 8 pounds per bucket.
- Barbed and lock staple finish.
- Extra sharp and with holding points.

Advantages:

- Extra holding power on wood posts.
- Easy to handle and install.
- Easy to store.
- Meets FF-N-105B.



8 # Bucket Barbed and Knurled Staples

Deacero Part No.	Gauge	Length	Package (Pounds per Bucket)	Finish	Boxes per Pallet (4 Buckets per Box)	Staple
(")						
7479	8	1 1/2	8	GALVANIZED	45	BARBED
7480	8	1 1/4	8	GALVANIZED	45	BARBED
7466	9	1 1/4	8	GALVANIZED	45	KNURLED
7467	9	1 1/2	8	GALVANIZED	45	KNURLED
7468	9	1 3/4	8	GALVANIZED	45	KNURLED



GALVANIZED WIRE

Uses:

- Lawn and garden fencing.
- Home improvements.
- Fencing support.
- Do it yourself (DIY) projects.

Features:

- Bright galvanized.
- Uniformly zinc coated.
- PVC coated available.

Advantages:

- Easy to handle and install.
- Adaptable for all fencing needs.
- Meets ASTM-A-641.



Galvanized Wire

Deacero Part No.	Gauge	Coil Weight	Coil Length Approx.	Rolls per Pallet
(')				
5524	9	100	1711	5

Galvanized Wire Class 3 (10 Pounds)

Deacero Part No.	Gauge	Coil Weight	Coil Length Approx.	Rolls per Pallet
(')				
5570	9	10	171	100
5576	11	10	260	100
5582	14	10	585	100
5585	16	10	975	100
5610	12.5	10	406	100

Galvanized Wire Class 3 (100 Pounds)

Deacero Part No.	Gauge	Coil Weight	Coil Length Approx.	Rolls per Pallet
(')				
5572	9	100	1711	5
5575	10	100	2057	5
5578	11	100	2603	5
5581	12	100	3336	5
5584	14	100	5858	5
5587	16	100	9753	5
5612	12.5	100	4068	5



SMOOTH GALVANIZED WIRE

Uses:

- Electrical installations.
- Home improvements.
- Clotheslines.
- Lawn and garden fencing.
- Art and craft work.

Features:

- Smooth galvanized.
- Uniformly zinc coated.
- Handi roll design.

Advantages:

- Easy to handle and use.
- Easy to store.
- Multipurpose.
- Thin gauge prevents wire from getting tangled.
- Meets ASTM-A-641.



Galvanized Wire Coil

Deacero Part No.	Gauge	Coil Weight	FT per Roll	Rolls per Box	Boxes per Pallet
31039	16	2.2	215	20	36
31040	18	2.2	358	20	36
31041	20	2.2	759	20	36
37601	14.5	2.2	155	20	36



BALER WIRE

Uses:

- Hay bales (wheat, sorghum, corn alfalfa, etc).

Features:

- Oil coated.
- Plastic strapped.
- Colored tags for "start - end" wire points.
- Cardboard protected.
- Usage instructions on product packaging.

Advantages:

- Easy uncoiling.
- Easy to install and handle on any bailing equipment.
- Straps keep roll on its original shape during usage time.
- Minimum wire waste.
- Does not get stuck in the equipment.
- Long lasting wire lubrication.
- Meets ASTM-A-853.



Baler Wire

Deacero Part No.	Gauge	Coil Length	Box Weight	Boxes per Pallet
(")				
5692	14.5	6500	104	36



STAYLOCK FENCE

Uses:

- Deer and game fencing.
- Exotic animals fencing and confinement.
- Heavy cattle fencing.
- Goat fencing.

Features:

- Staylock knot.
- Heavy duty galvanized.
- Extra and uniformly zinc coated.
- Wire tension curve.
- Pre-stripped rolls (all of the Staylock fence rolls comes with 18" of vertical stays removed from both ends of the roll).
- Extra strong bottom and top wire lines.

Advantages:

- Resistant to animal impacts.
- Extremely weather resistant.
- Bottom mesh spacing prevents small animal from getting in or out the field.
- Top mesh spacing prevents big animals from getting in or out the field.
- Easy to install.
- Saves time, labor and money when installing.
- Long lasting.
- Meets ASTM-A-116 Class 3.



StayLock High Tensile Class 3

Deacero Part No.	Filler Gauge	Top / Bottom Gauge	Fence Height	Roll Length	Rolls per Pallet	Horiz. Wires	Spacing Between Vertical Wires
			(")	(')			(")
6792	12.5	12	96	300	6	20	6
6797	12.5	12	49	330	8	9	12
6798	12.5	12	48	660	5	13	12
6799	12.5	12	49	660	6	9	12
6968	12.5	12	42	330	8	8	12
6970	12.5	12	49	330	6	9	6
6971	12.5	12	96	165	6	20	3
6972	12.5	12	120	330	4	20	6
6980	12.5	12	48	330	6	13	6
6981	12.5	12	48	330	9	13	12
6982	12.5	12	61	330	6	15	6
6983	12.5	12	75	330	6	17	6

FENCE PROFILES

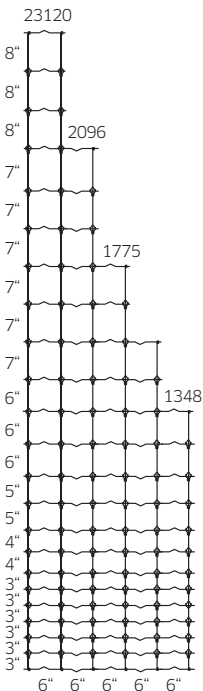

- Won't slip vertically or horizontally.
- Solid vertical stay wire resists bending or folding.
- Extra-heavy galvanization.



**Fixed Knot
(StayLock Fence)**

Vs.



**Regular Knot
(Field Fence)**

- May slide horizontally and fold vertically, prone to untwisting.
- Typically has low galvanization.





rangemasterfence.com



USA 1 800 332 2376 | CANADA 1 877 343 8575
8411 Irvington Blvd., Ste B, Houston, TX 77022

©Rangemaster. ©Deacero. All rights reserved.