

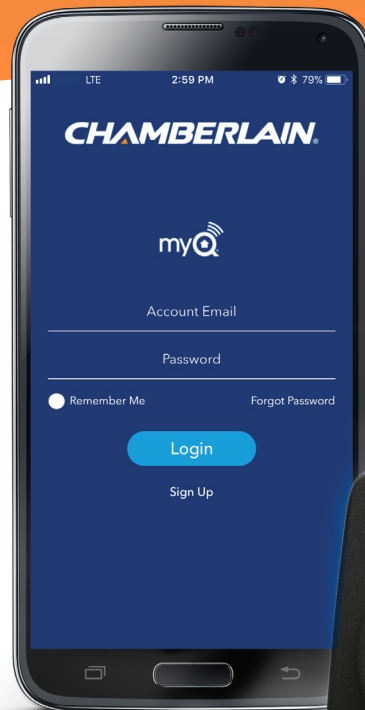

Smart Garage™ Hub Manual

For Android™
devices

MYQ-G0301 • MYQ-G0301C
MYQ-G0301-D • MYQ-G0301LA



by

CHAMBERLAIN®

Before You Start

WARNING

To reduce the risk of SEVERE INJURY to persons:

- DO NOT enable the MyQ® Smart Garage™ Hub if operating either one-piece or swinging doors. To be enabled ONLY on a sectional door.

 **WARNING:** This product can expose you to chemicals including lead, which are known to the State of California to cause cancer or birth defects or other reproductive harm. For more information go to www.P65Warnings.ca.gov



Read instructions thoroughly BEFORE beginning.

If using this product with residential door openers, this product must be used only with door openers manufactured after 1993 that utilize photoelectric sensors. The photoelectric sensors are always located on or near the bottom of the door track.

Before you start, you MUST have...

- A router with 2.4GHz Wi-Fi® frequency
- Router configured with 802.11 B/G/N
- Router within 50 ft. of MyQ Smart Garage Hub

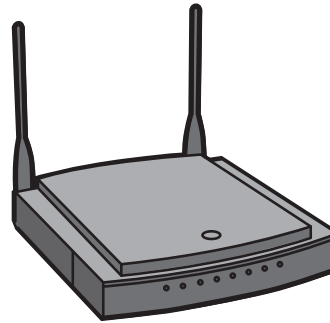

- Mobile phone connected to your home Wi-Fi network
- Home Wi-Fi network password
- Latest version of MyQ App



- Compatible garage door opener (see [Compatible Garage Door Openers](#) on page 20)
- Locate program or learn button on the garage door opener

See [Appendix](#) on page 21 for a more detailed list of program or learn button locations.

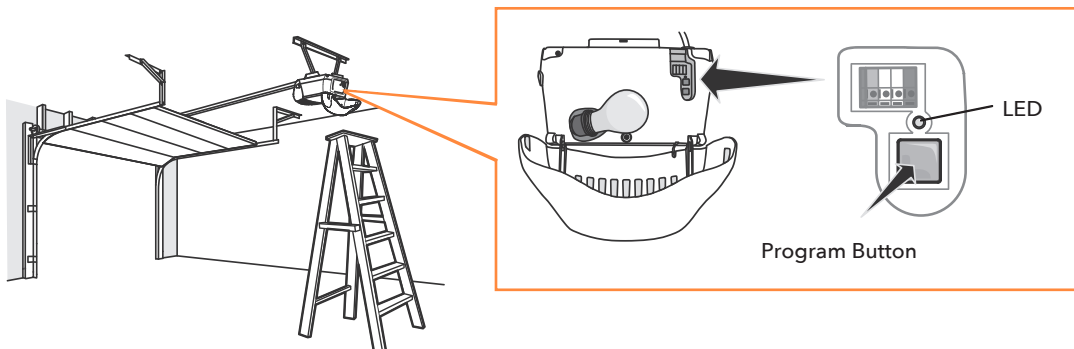

Before You Start

What's in the Box

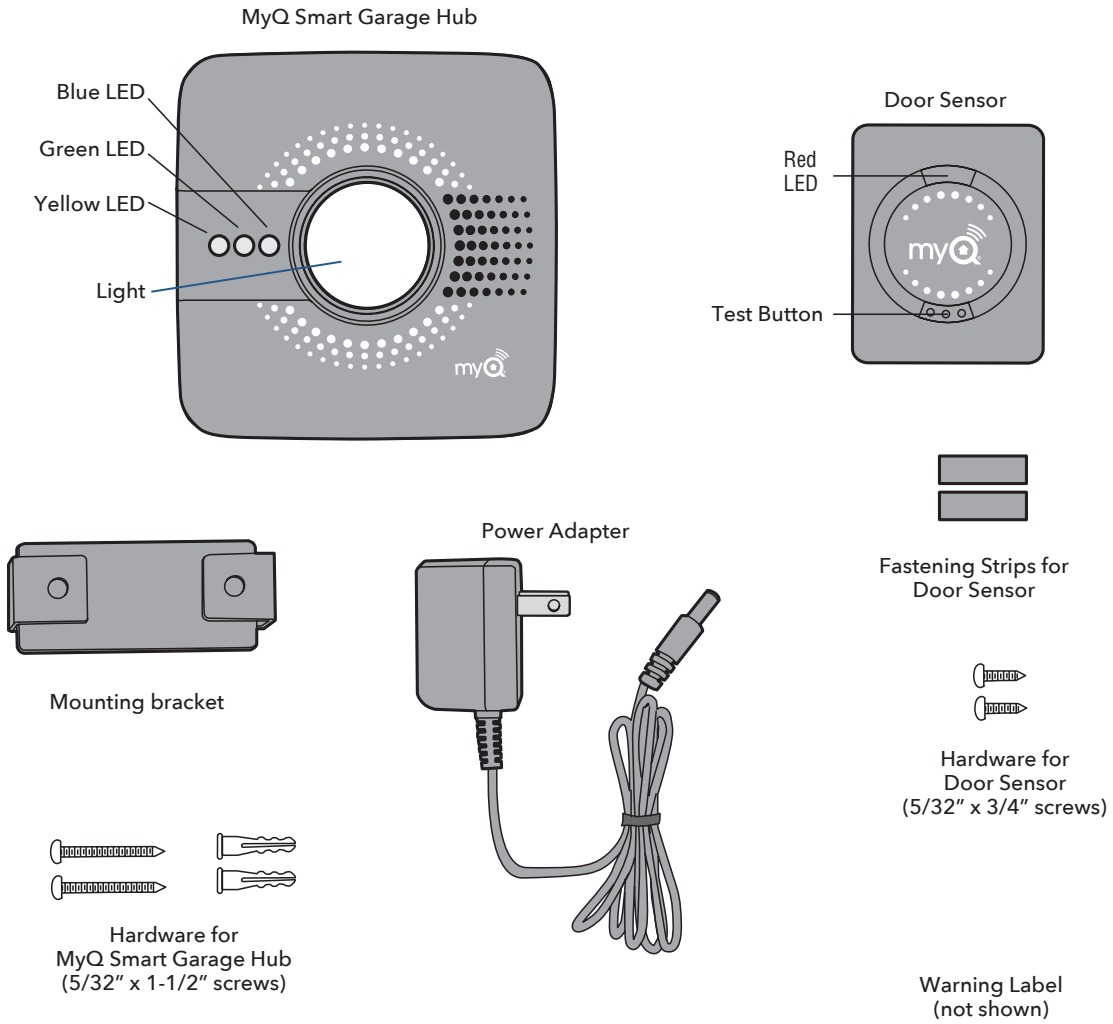

Tools Needed: Drill, 5/32" Drill Bit, Screwdriver, Ladder

Wireless Setup and Installation

Step 1: Check your Wi-Fi signal

Make sure your mobile phone is connected to your Wi-Fi network. Hold the mobile phone near where you plan to install the MyQ Smart Garage Hub.

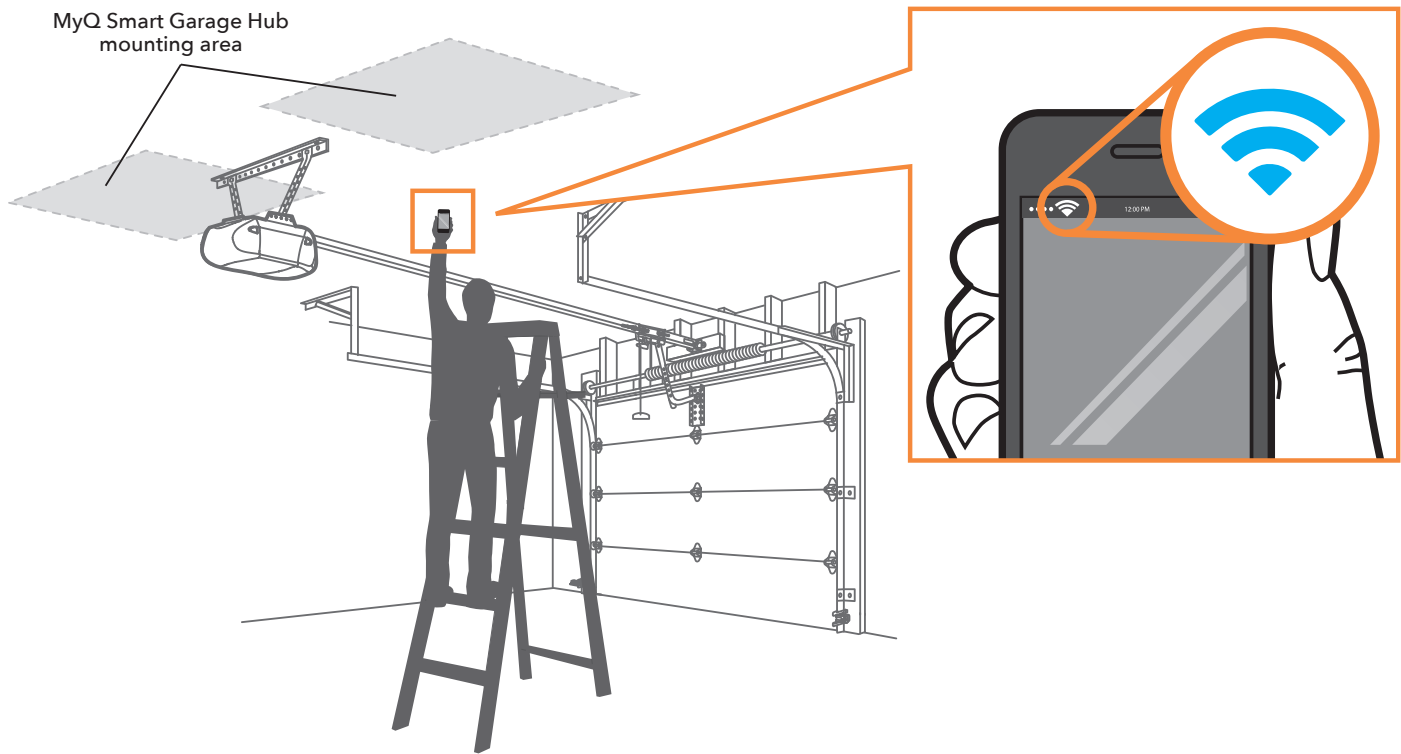

If you see:



Wi-Fi signal is strong. You're all set! Proceed to next step.



Wi-Fi signal is weak. The MyQ Smart Garage Hub may not connect to your Wi-Fi network. If it doesn't connect, try one of the options below.



No Wi-Fi signal. Try one of the following options:

- Move your router closer to the garage to minimize interference from walls and other objects.
- Buy a Wi-Fi range extender.

 To watch a video on How to test your Wi-Fi Signal Strength before setting up your MyQ® product, go to youtu.be/_Ow1wVF-7AU

Wireless Setup and Installation

Step 2: Install door sensor

1. Remove the pull tab from the door sensor to activate the battery.
2. Test the door sensor by pushing the test button and confirming the LED on the door sensor blinks.
If the LED on the door sensor does not blink, see [Troubleshooting](#) on page 16.
3. Install the door sensor on the top panel of the garage door using the fastening strips or provided hardware.

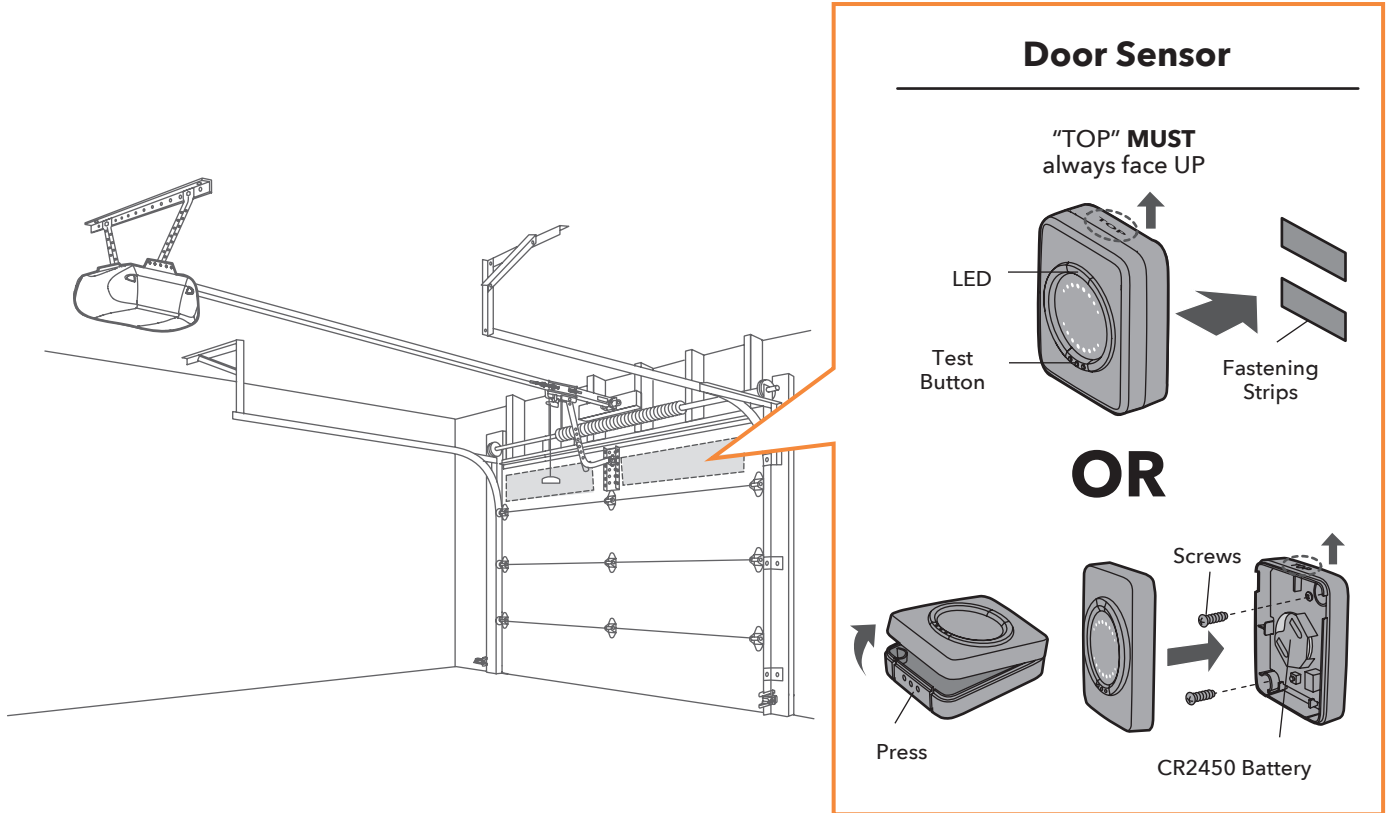

IMPORTANT: Door sensor **MUST** be installed to read "myQ" lettering right-side up.

Step 3: Download the MyQ® App

If you already have the MyQ App, verify you have the latest version. To confirm you have the latest version of the app, go to Google Play™ store and search for the Chamberlain MyQ App. If you see Update, tap Update.



Wireless Setup and Installation

If you have already registered a MyQ account, skip this step and login.

Step 4: Create and Register your MyQ Account

1. Open the MyQ App and tap **Sign Up**.
2. Enter first name, last name, valid email address, and password (twice), country, and zip code.
NOTES:
 - Check email address for errors.
 - Use a valid email address you can access.
 - If the email address you are attempting to use is already in the MyQ system, you will receive an error message.
 - If necessary, tap **Forgot Password** to retrieve the password for that email and login. For more information, see [Troubleshooting](#) on page 16.
3. Tap **Submit** (top right-hand corner). An email will be sent to the email address you provided.
5. Open the email from Chamberlain support and tap the link to complete your registration. The MyQ App will open, verifying registration of email address was successful. **NOTE:** If you didn't receive an email, check the *Junk or Spam folder*.
6. Tap **OK**.
7. Enter your email address and password and tap **Login**.

Congratulations! Registration of your account is now complete.

The screenshot shows the 'Sign Up' screen in the MyQ app. At the top, there is a status bar with the time 12:08 PM and 91% battery. The app header has 'Cancel', 'Sign Up', and a circled 'Submit' button. The form contains the following fields: 'First Name', 'Last Name', 'Email', 'Password', 'Verify Password', 'Country: None Selected >', and 'Zip'. Below the form, there is a note: 'Passwords need to be at least 8 characters in length and must contain at least 3 of the following 4 types of characters: uppercase letter, lowercase letter, number or symbol.' At the bottom, it says 'By signing up you agree to the [License Agreement and Terms Of Use](#)'.

Wireless Setup and Installation



Step 5: Power up the MyQ Smart Garage Hub

Find a convenient location and plug in the MyQ Smart Garage Hub. Wait for the blue LED to blink.

If blue LED is not blinking:

Unplug and plug back in.

If the blue LED still does not blink, reset to factory default:

1. Press and hold the Settings button  until the blue LED blinks (about 10 seconds) then release.
2. Press and hold Settings button  again until the MyQ Smart Garage Hub beeps.

IMPORTANT NOTE: Resetting the MyQ Smart Garage Hub to factory default erases the Wi-Fi settings, erases door sensors, and removes the MyQ Smart Garage Hub from the currently paired MyQ account.

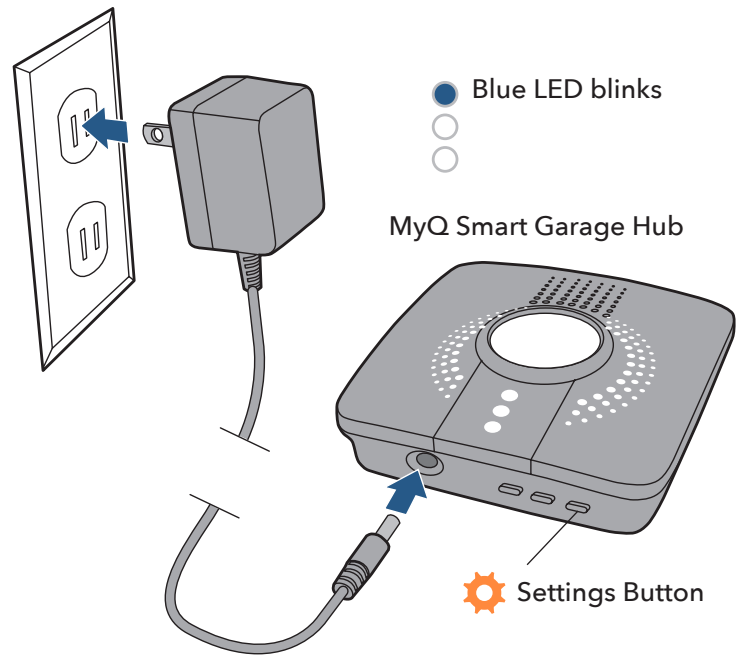

Step 6: Login to MyQ App

Enter the email and password you used to register your account and tap Login.

TIP: Select **Remember Me** if you want the MyQ App to remember your email address and password. You can change the security settings within the MyQ App by tapping the menu bar in top-left corner and then your name on bottom-left to access settings.

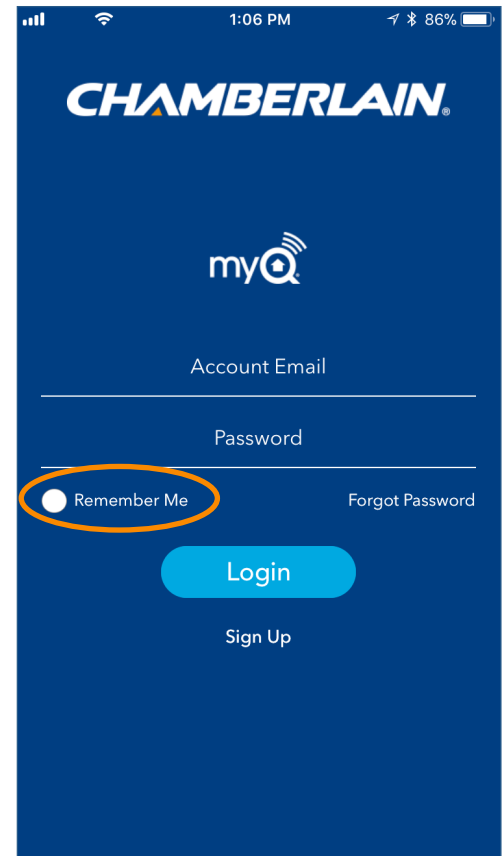

Wireless Setup and Installation

Step 7: Connect the Smart Garage Hub to the Wi-Fi Network

In the MyQ App:

1. Tap **Get Started** or tap “+”.

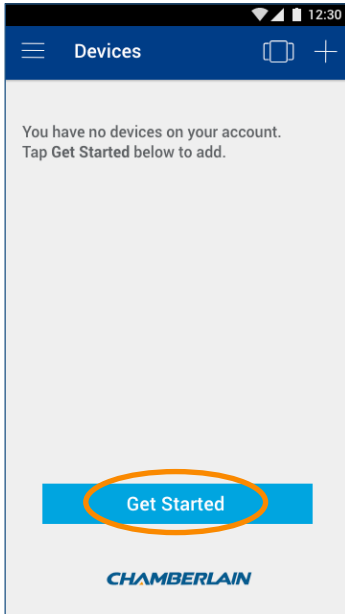

2. Tap “MyQ-*nnn*” under Discoverable Devices.

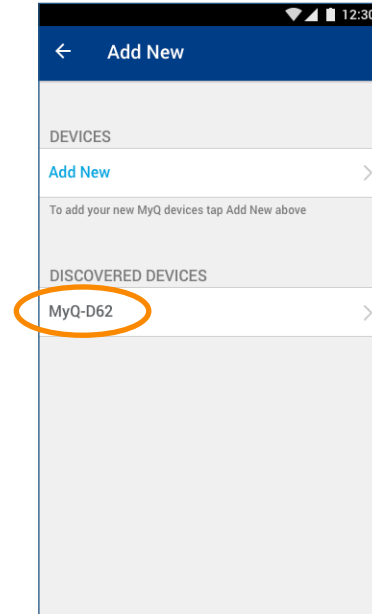

3. Tap **YES** to connect your MyQ Smart Garage Hub to your Wi-Fi network.

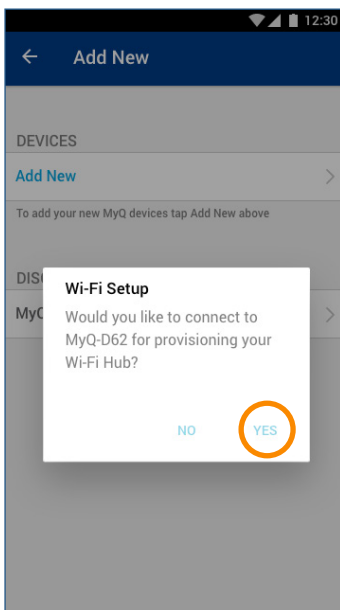

Wireless Setup and Installation

Step 7: Connect the Smart Garage Hub to your Wi-Fi Network *continued*

4. Select your home Wi-Fi network from the list.

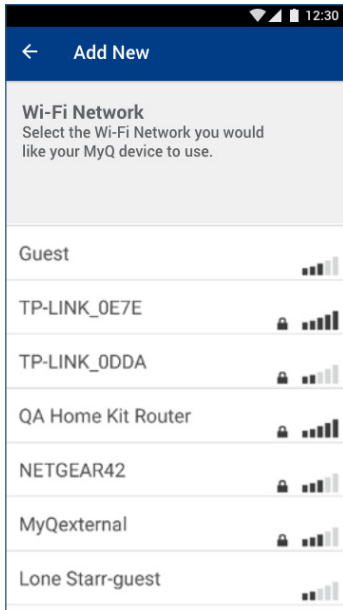

5. Enter your home Wi-Fi network password and tap **Connect**.
Wait for the solid green LED on your MyQ Smart Garage Hub. This can take up to 2 minutes.

Result: LED is solid green. **NOTE:** If the LED is not solid green, see [Troubleshooting](#) on page 16.

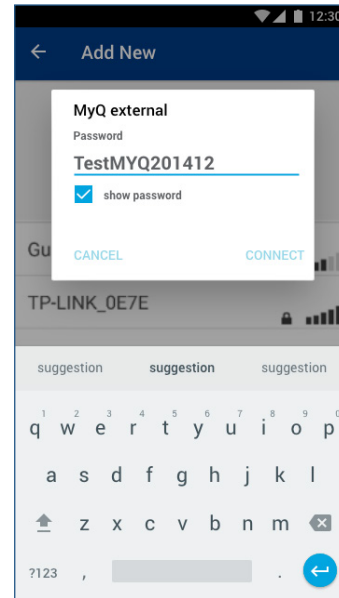

6. Enter a name for your MyQ Smart Garage Hub and tap **Save**.

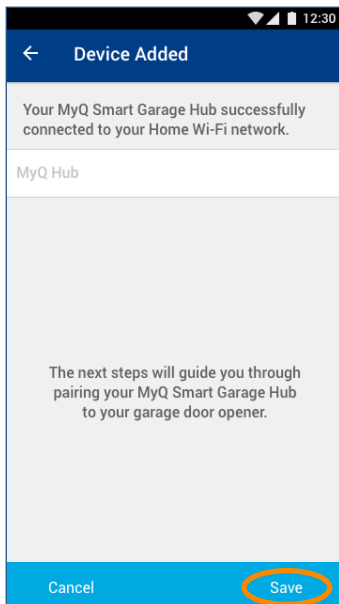

Wireless Setup and Installation

Step 8: Add New Device

Now that your MyQ Smart Garage Hub is connected to your home Wi-Fi network, the next steps will guide you through the process of pairing your garage door opener to your MyQ Smart Garage hub.

TIP: A device is any MyQ accessory that can be paired with your MyQ Smart Garage hub for monitoring and control. This includes MyQ Lighting accessories and an add-on door sensor that expands your MyQ functionality to a second garage door.

The following steps are to add a garage door opener.

1. Confirm your door sensor is mounted and tap **Next**.
2. Locate the test button on the door sensor and tap **Next**.

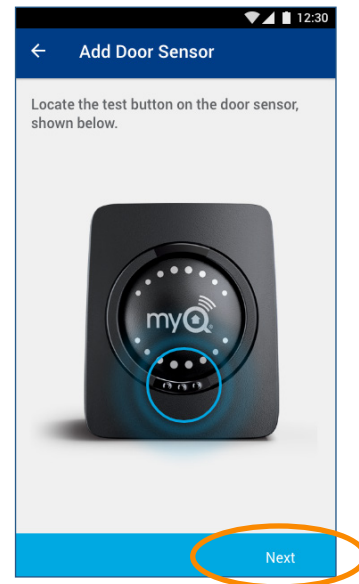
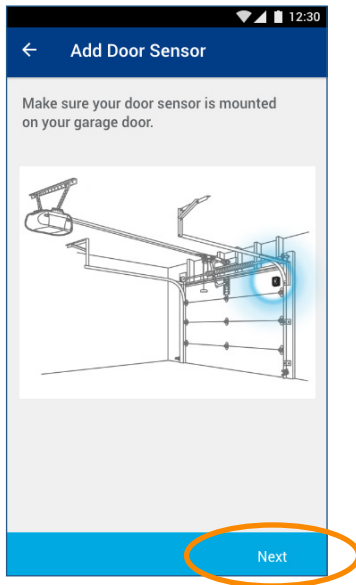

3. Press and release the test button on the door sensor. The MyQ Smart Garage Hub will beep and the light will flash.

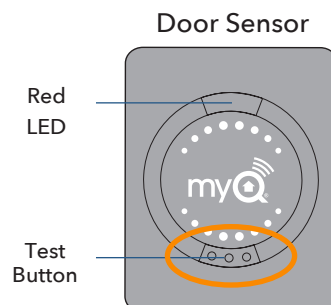
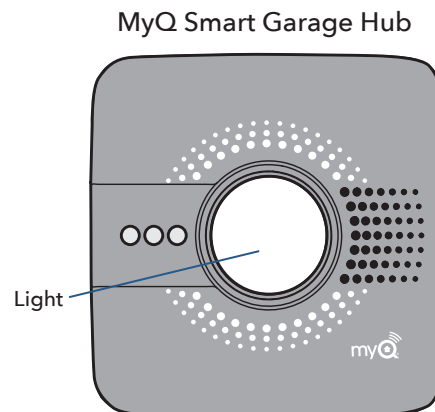
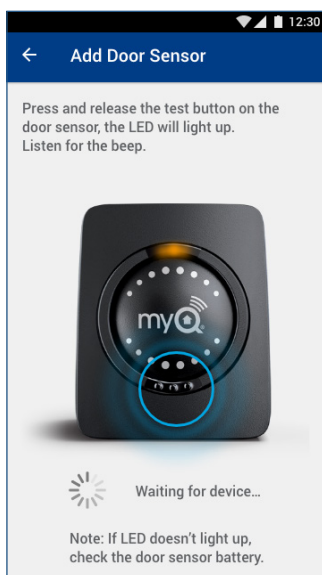

Wireless Setup and Installation

Step 8: Add New Device *continued*

NOTE: You will need the brand and model located on the motor head of your garage door opener.

The following steps will activate your garage door opener. Make sure your garage door is clear.

5. In the MyQ App select **Brand/Model** of garage door opener. Tap and select your garage door opener from drop down list. If prompted, choose the color of the program button from the drop down list.

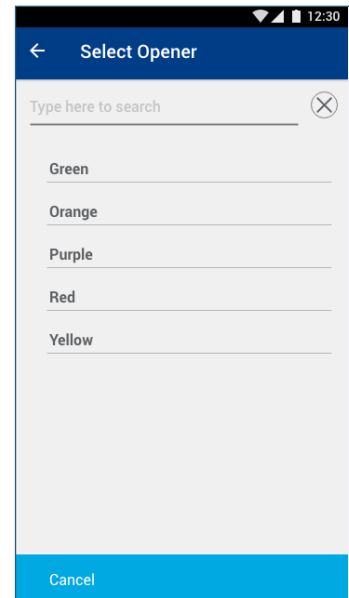
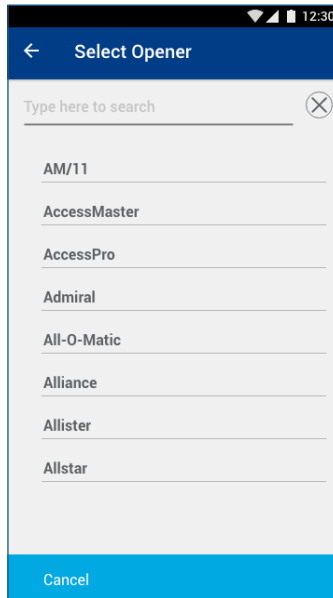
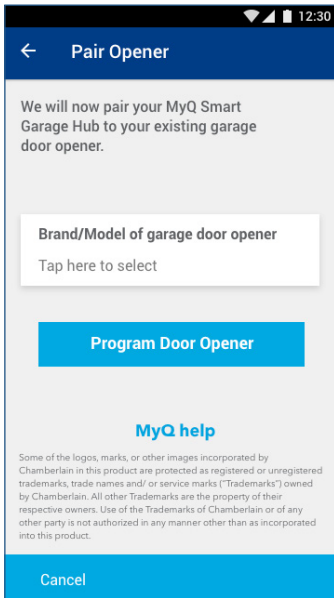

6. Read warning then tap **Continue**.

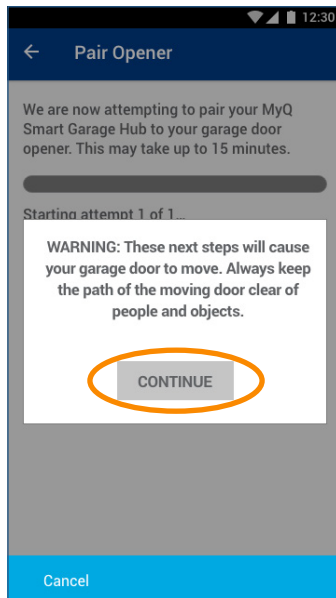

Wireless Setup and Installation

Step 8: Add New Device *continued*

See **Appendix** on page 21 for location of garage door opener program or learn buttons.

7. On your garage door opener - press and release the program or learn button.

NOTE: Release the button quickly for best results.

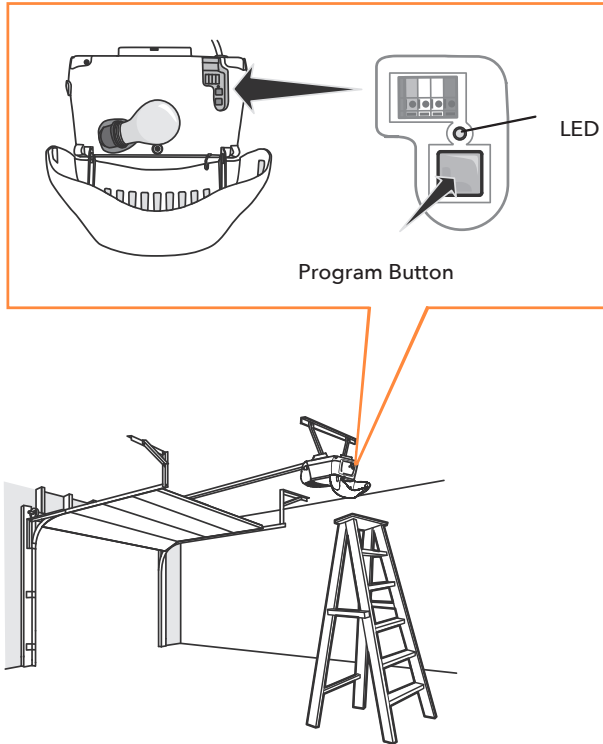

8. In MyQ App, tap I have pressed the Program Button.

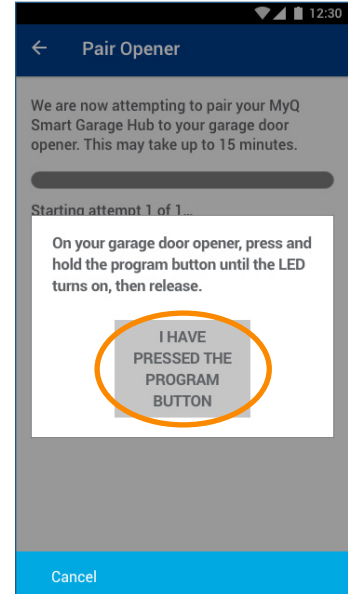

Result: Door should move.

If the door moves, go to next step. If the door doesn't move, the MyQ App will prompt you to try again. If you're still unsuccessful, see **Troubleshooting** on page 17.

9. When the garage door opener is paired, in the MyQ App enter a name for the door and tap **Next**.
10. **Success!** Tap **Finish** to continue to the next page for instructions on mounting your hub.

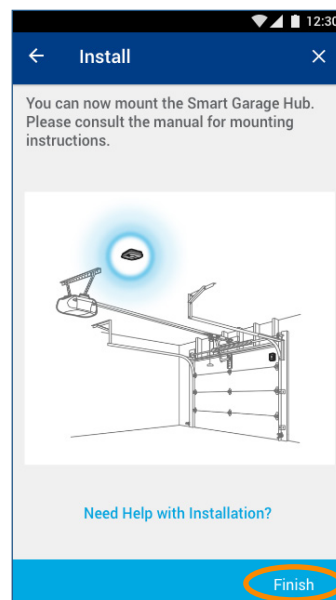
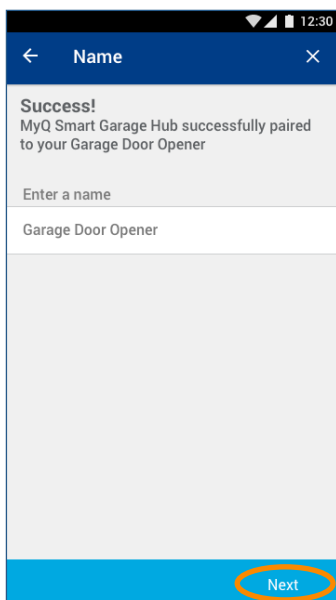

Wireless Setup and Installation

Step 9: Mount the MyQ Smart Garage Hub

- Install the MyQ Smart Garage Hub on the ceiling 4-6 feet from the garage door opener, and within 4 feet from an AC power outlet.
 1. Use the MyQ Smart Garage Hub bracket as a template to drill 5/32" pilot holes.
 2. Attach the bracket.
 3. Slide the MyQ Smart Garage Hub onto the bracket.
- Plug it in and confirm the hub's green LED turns on solid.
If the hub's LED does not turn on within a few minutes, see **Troubleshooting** on page 16.
The MyQ Smart Garage Hub light **MUST** be visible if you're standing in the doorway of the garage.

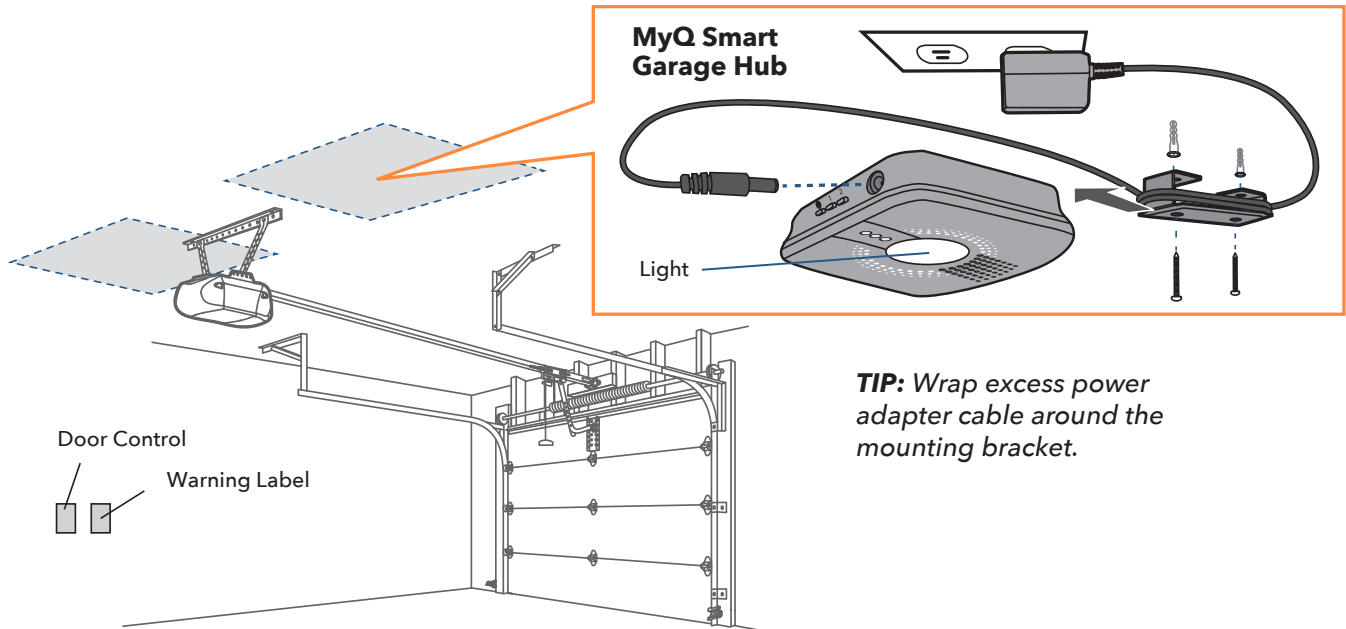

TIP: Wrap excess power adapter cable around the mounting bracket.

Step 10: Apply Warning Label

- Attach the warning label to the wall next to the door control.

Operation

⚠ WARNING

ALWAYS keep garage door in sight and away from people and objects until completely closed. NO ONE SHOULD CROSS THE PATH OF THE MOVING DOOR.

To open and close your garage door from the MyQ App, tap the garage door icon from the Devices screen then Tap **OPEN DOOR** or **CLOSE DOOR**. This screen also displays the length of time since your garage door opened or closed.

To change the Devices screen view, tap the toggle icon next to the +.

When closing your garage door from the MyQ App, your MyQ Smart Garage Hub will beep and the MyQ Smart Garage Hub light will flash as a safety alert. Caution should be taken around the moving door.

In the Devices screen, you can see up to four devices.

NOTES:

- The MyQ Smart Garage Hub can be associated to one MyQ account only.
- You can connect up to 2 door sensors and up to 16 MyQ accessories (with a second door sensor purchased separately).

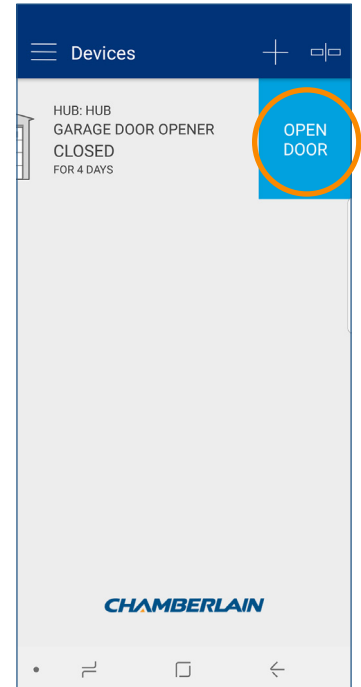
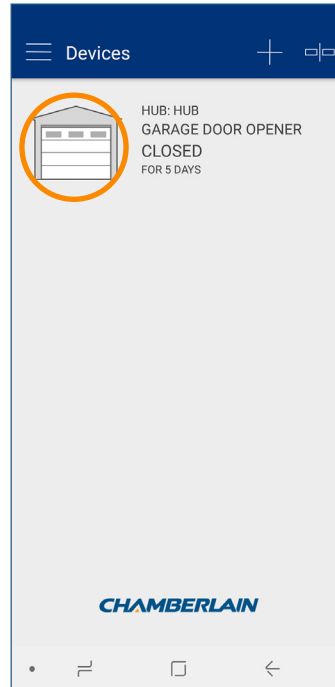

Getting Started

Your new MyQ Smart Garage Hub was designed to deliver peace of mind by allowing you to always know the status of your garage door and by providing control of your garage door from anywhere.

The following MyQ functionality allows you to get the most out of your new system:

ALERTS

Alerts can send you a push notification and/or email when a MyQ device changes state (garage door opens, remote light turns on, etc.)

SCHEDULES

Schedules program your device to activate at specified days and times and can also be programmed to send push notifications and email to your phone.

PARTNERS

MyQ integrates with a number of other technologies to link with your existing Smart Home products. For the most up to date list of MyQ partners, please visit www.chamberlain.com/myqpartners

You can view more devices by scrolling through the view types in the top right corner.

See all available features by tapping the **Menu** button.

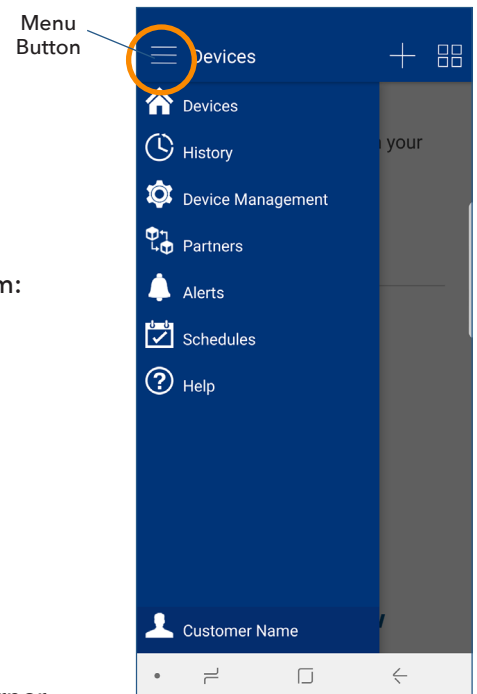

Maintenance

Test

TIP: Test your door sensor every 6 months or if the MyQ system is not working as expected.

- **To test for a low battery:** Press and release the test button on the door sensor, The LED on the door sensor should blink the MyQ Smart Garage Hub should beep. Wait 5-10 seconds, then repeat this test 5 more times (wait 5-10 seconds between each test).

If the LED doesn't blink or the MyQ Smart Garage Hub doesn't beep with each press, replace the battery in the door sensor. Use a 3V Lithium battery size CR2450.

⚠ WARNING

- To prevent possible SERIOUS INJURY or DEATH:
- NEVER allow small children near batteries.
 - If battery is swallowed, immediately notify doctor.
- To reduce risk of fire, explosion or chemical burn:
- Replace ONLY with 3V CR2450 coin batteries.
 - Do NOT recharge, disassemble, heat above 212°F (100°C) or incinerate.

Battery

Dispose of batteries properly. Replace ONLY with 3V CR2450 coin batteries.

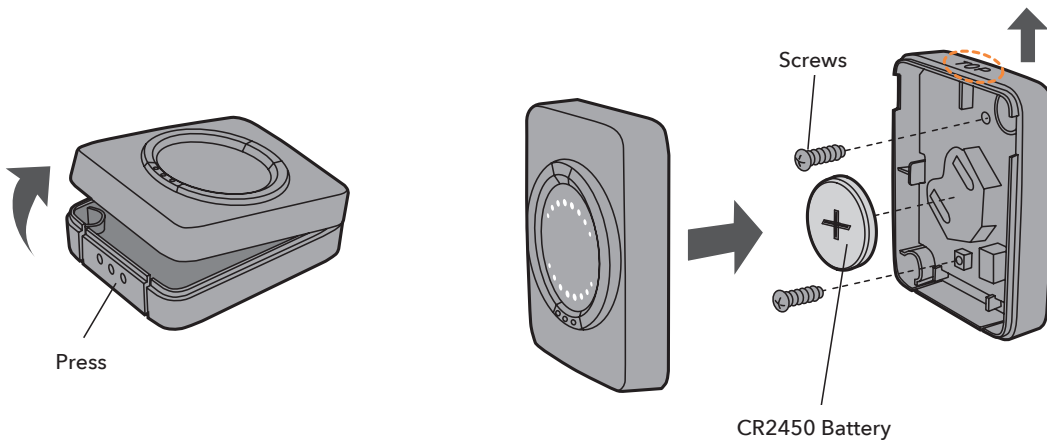

Troubleshooting



To watch videos on how to install the MyQ Smart Garage Hub, go to [videos](#).

When I press the test button in the door sensor, why doesn't the red LED blink?

1. Make sure you remove the pull tab from the door sensor.
2. Debris may be present on the battery. Open the door sensor by pressing the button on the bottom and pulling the front cover off.
3. Slide the battery out to make sure that the pull tab didn't break off under the battery or that there is no residue on the battery. After you confirm put the battery back in.
4. Close the door sensor and press the test button, if the LED still doesn't come on replace the battery. If the LED blinks, install the door sensor to the top section of your garage door. The battery is a 3V Lithium battery size CR2450. Door sensor installation is on [page 5](#).

When I attempt to create a MyQ account, why do I get the error message "That username already exists. Check username or use another username. (201)"?

Your email address was previously used to create a MyQ account. Click Forgot Password on the login screen of the MyQ App and a temporary password will be emailed to that email address. Once you log in you are ready to go through the Wireless Setup and Installation on [page 7](#).

When I attempt to connect my MyQ Smart Garage Hub to my Wi-Fi network, why don't I get a solid green LED light?

When attempting to connect to your Wi-Fi network the LED lights on your MyQ Smart Garage Hub will go through a sequence of LED light flashes before it goes solid green. The LED illumination pattern indicates the type of issue. Check what the LED lights are doing and follow the steps indicated.

Goes back to flashing blue

- Verify your Wi-Fi password.

Flashing blue and green

- Power cycle your router.
- Check Wi-Fi signal where the MyQ Smart Garage Hub is located ([page 4](#)).
- Check router settings ([page 2](#)).
- Clear the Wi-Fi settings on the MyQ Smart Garage Hub and reconnect to your Wi-Fi network.

To clear the Wi-Fi settings: Press and hold the Settings button on the MyQ Smart Garage Hub until the blue LED blinks (about 10 seconds) then release. Then reconnect to Wi-Fi.

Troubleshooting

When attempting to pair my garage door opener to the MyQ Smart Garage Hub, why doesn't the door move?

When you are not able to pair your garage door opener and MyQ Smart Garage Hub there are a couple things to check for. You need to confirm that you are adding a compatible garage door opener and that the door sensor is working properly.

Once you have confirmed that your garage door opener is compatible (see Appendix for compatible garage door openers), test your door sensor.

Door sensor test: Press the test button on the door sensor. The MyQ Smart Garage Hub should beep and the red LED on the door sensor should blink. If it doesn't, replace the battery. If it does, follow the steps to test for low battery.

To test for a low battery: Press and release the test button on the door sensor, the MyQ Smart Garage Hub should beep. Wait 5-10 seconds, then repeat five more times. (Press, beep and wait...repeat). The MyQ Smart Garage Hub should beep with each press. (If you don't wait 5 seconds you may not hear a beep.) If you don't hear a beep with each press, replace the battery. The battery is a 3V Lithium battery size CR2450.

Now that your door sensor is working, log back in the MyQ App to pair your garage door opener to the MyQ Smart Garage Hub.

1. Tap the +.
2. Tap the name of your MyQ Smart Garage Hub under **Hubs**.
3. Select **Garage Door Opener**.
4. Tap **Yes** that you are using a door sensor.
5. Locate the test button on the door sensor.
6. Press and release the test button on the door sensor, as directed by the MyQ App.
7. Select the **Brand/Model** of your garage door opener. If prompted choose the color of the program button on the garage door opener.
8. Tap **Program Door Opener**.
9. Read the warning in the MyQ App and tap **Continue**.
10. Press and release the program button on your garage door opener. In the MyQ App, tap **I have pressed the program button**.
11. Name the garage door opener and tap **Submit** in the upper right corner of the MyQ App.

Error messages and how to resolve

When I attempt to log into my account, I get the error **The user is locked out. (207)**, how do I unlock my account? An account gets locked out when you have entered your password incorrectly too many times. Follow these steps to resolve.

1. Tap **Forgot Password**
2. Enter the email address you used to create the MyQ account. You will receive an email containing a new generic password. **NOTE:** *If you didn't receive an email, check the Junk or Spam filter.*
3. Login to your MyQ account with your Account Email and the new generic password.
NOTE: *The new generic password remains valid until you change it.*
4. Tap the **Menu** in top-left corner, select your name in bottom-left corner, and change your password to a specific and confidential password.



Troubleshooting

When I attempt to add my serial number to my account, I get the error **That device is on another user's account. Unable to add (310)**, how do I resolve this issue?

This error means that the MyQ Smart Garage Hub has been added to another MyQ account. To resolve this issue, you need to perform a **factory default** on the MyQ Smart Garage Hub (see below).

Factory Default

Setting the MyQ Smart Garage Hub back to factory default erases the Wi-Fi settings, erases door sensors, and removes the MyQ Smart Garage Hub from the MyQ account.

1. Press and hold the Settings button  until the blue LED blinks (about 10 seconds) then release.
2. Press and hold Settings button  again until the MyQ Smart Garage Hub beeps. The MyQ Smart Garage Hub is set to factory default.

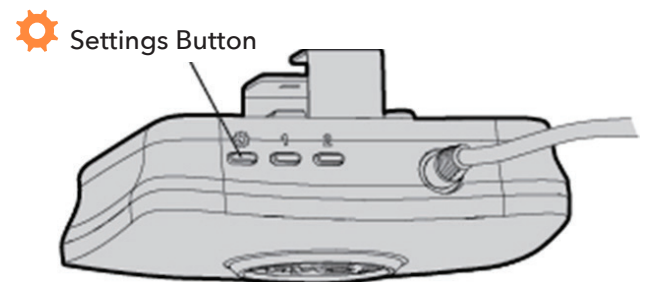

Accessories

PILCEV-P1

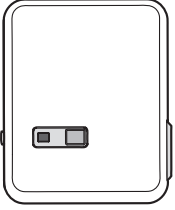

MyQ Remote Lamp Control

Monitor and control this plug-in lamp switch with the MyQ App.

WSLCEV-P1

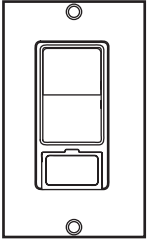

MyQ Interior/Exterior Light Switch

Monitor and control this wall light switch with the MyQ App.

MYQ-G0302: G821LMB-SENSOR

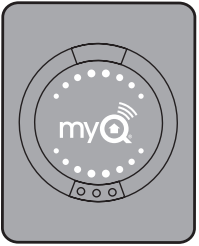

MyQ Smart Garage Hub Add-on Door Sensor

Monitor and control this door sensor with the MyQ App. The MyQ Smart Garage Hub supports a second sensor that can be installed on a second garage.

NOT COMPATIBLE

MYQ-G0202 or 041D7924



Door Sensor

Appendix

Compatible Garage Door Openers

Unless specified, the MyQ Smart Garage Hub is compatible with the following brands of garage door openers manufactured after 1993 that utilize safety sensors.

- Chamberlain, LiftMaster, Craftsman and other Chamberlain manufactured garage door openers
- Wayne Dalton 372.5 MHz
- Linear
- Stanley
- Genie/Overhead Door manufactured 1993-2015. Not compatible to openers manufactured after 2016. MyQ Smart Garage Hubs with a date code of 04/18 or later are compatible with all Genie and overhead door openers manufactured since 1996.

Appendix

Locate the Program or Learn Button

Chamberlain Products

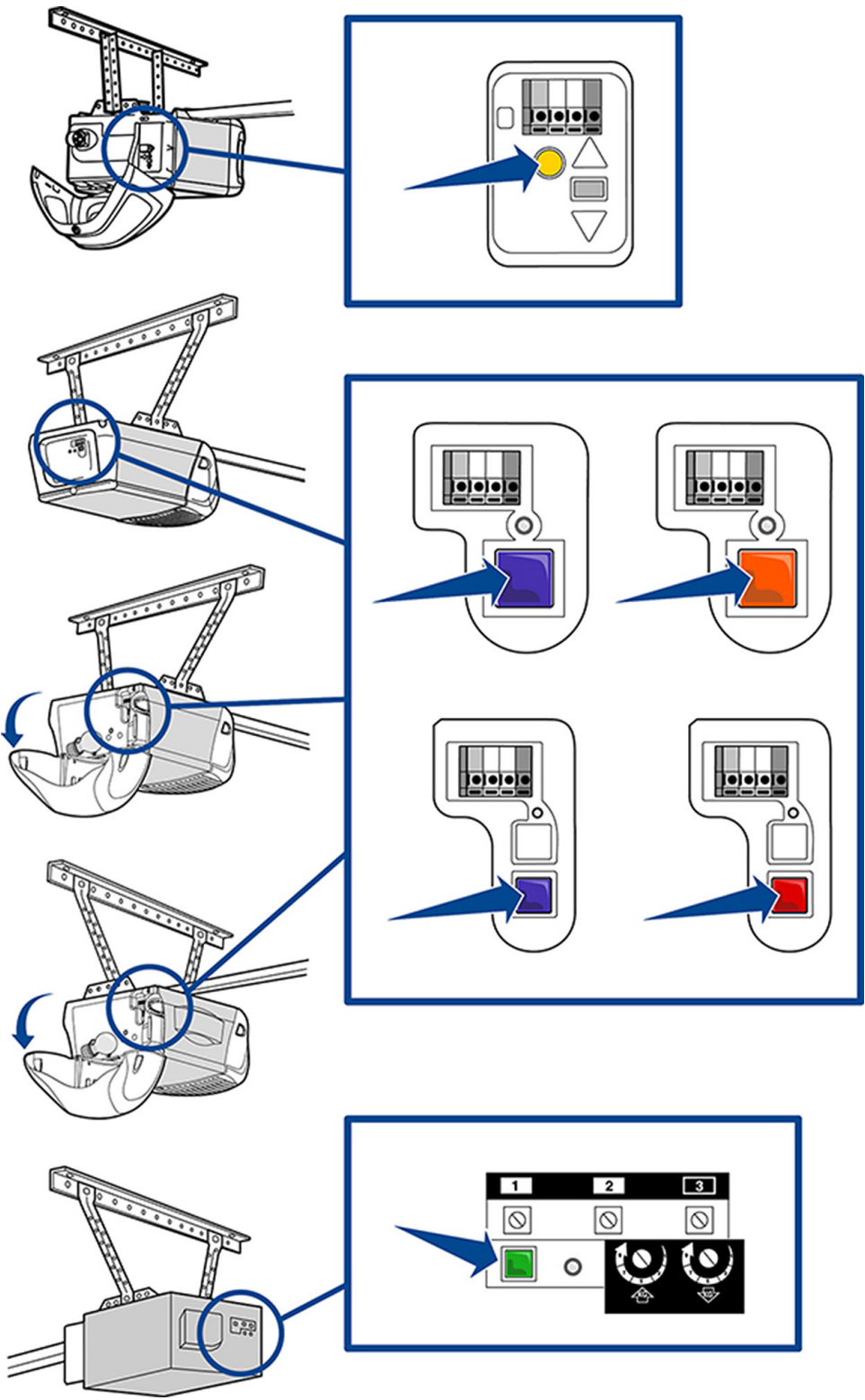

Appendix

Locate the Program or Learn Button

LiftMaster Products

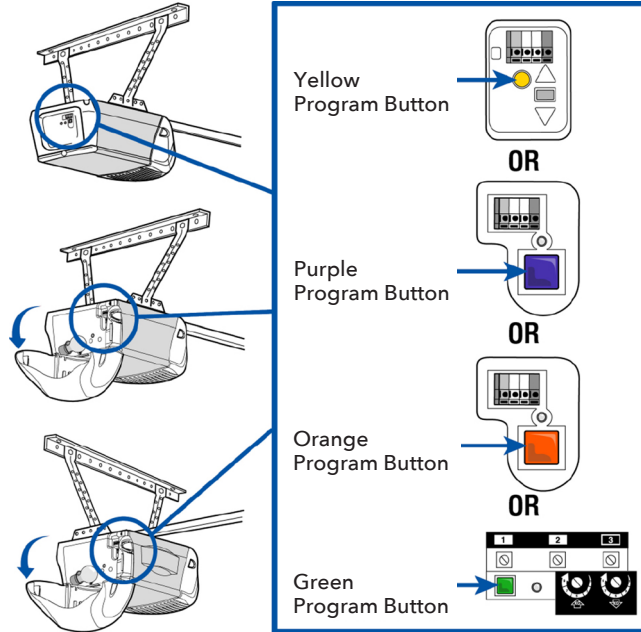

Overhead Door Products

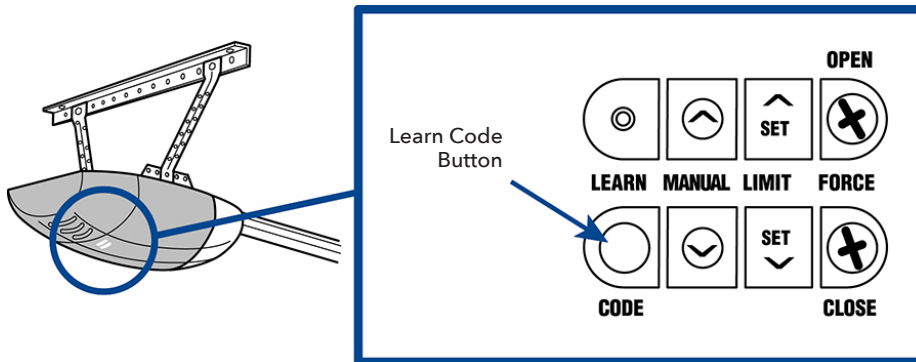

Appendix

Locate the Program or Learn Button

Genie Products

For compatible Genie garage door openers, see [Compatible Garage Door Openers](#) on page 20.

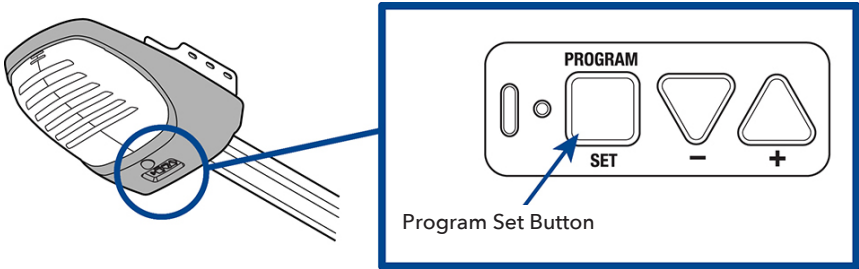
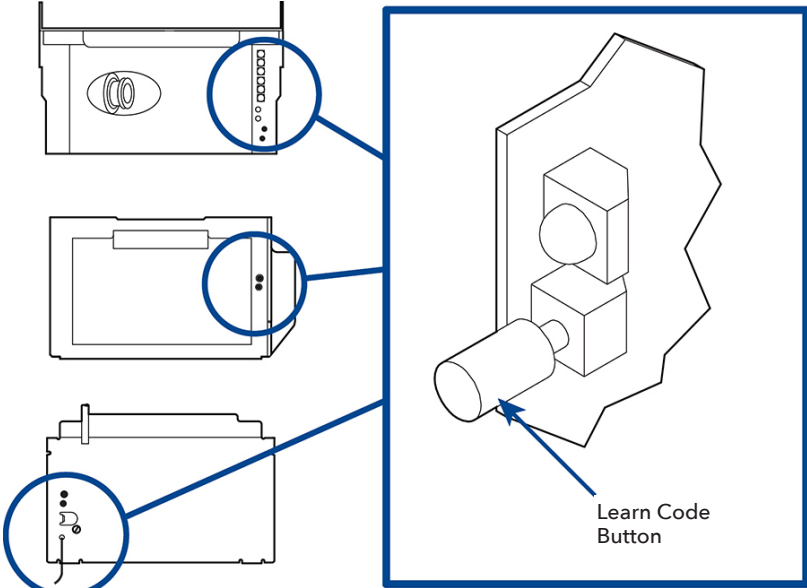

Appendix

Locate the Program or Learn Button

Linear Products

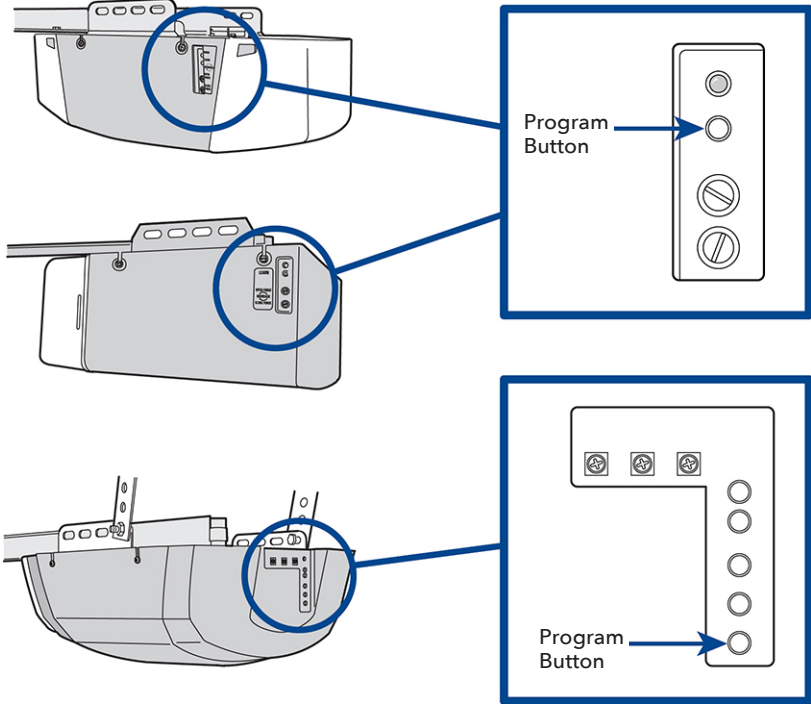

Wayne Dalton Products

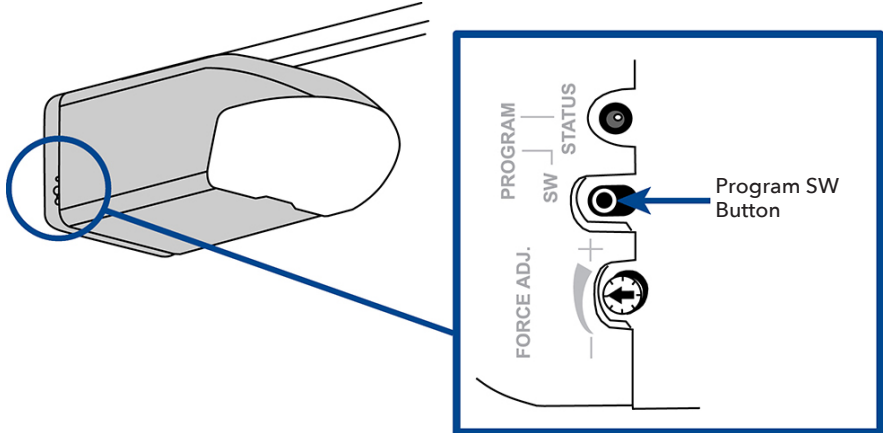

Appendix

Locate the Program or Learn Button

Stanley Products

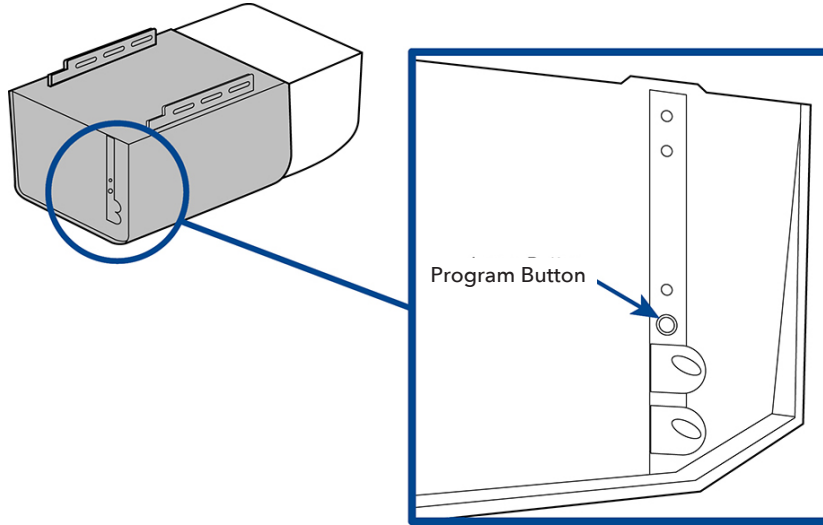

Warranty

Need Help?

Go to: www.chamberlain.com/MyQSupport

One Year Limited Warranty

The Chamberlain Group, Inc. warrants to the first consumer purchaser of this product that it is free from defect in materials and/or workmanship for a period of 1 year from the date of purchase.

Software Agreement

Use of this product and the software embedded within the product is subject to the copyright notices, terms, and conditions available at: www.mychamberlain.com/agreement

NOTICE: This device complies with Part 15 of the FCC rules and Industry Canada's license-exempt RSSs. Operation is subject to the following two conditions: (1) this device may not cause harmful interference, and (2) this device must accept any interference received, including interference that may cause undesired operation. Any changes or modifications not expressly approved by the party responsible for compliance could void the user's authority to operate the equipment.

This device must be installed to ensure a minimum 20 cm (8 in.) distance is maintained between users/bystanders and device.

This device has been tested and found to comply with the limits for a Class B digital device, pursuant to part 15 of the FCC rules and Industry Canada ICES standard. These limits are designed to provide reasonable protection against harmful interference in a residential installation. This equipment generates, uses and can radiate radio frequency energy and, if not installed and used in accordance with the instructions, may cause harmful interference to radio communications. However, there is no guarantee that interference will not occur in a particular installation. If this equipment does cause harmful interference to radio or television reception, which can be determined by turning the equipment off and on, the user is encouraged to try to correct the interference by one or more of the following measures:

- Reorient or relocate the receiving antenna.
- Increase the separation between the equipment and receiver.
- Connect the equipment into an outlet on a circuit different from that to which the receiver is connected.
- Consult the dealer or an experienced radio/TV technician for help.

Chamberlain, the Chamberlain logo, LiftMaster, MyQ® and the MyQ® logo are registered trademarks of The Chamberlain Group, Inc. Patents and patents pending. Android and Google are trademarks of Google Inc., registered in the U.S. and other countries. Google Play and the Google Play logo are trademarks of Google Inc. Wi-Fi® is a registered trademark of Wi-Fi Alliance. Genie is a trademark of Overhead Door Corporation. Overhead Door is a trademark of Overhead Door Corporation.

Linear is a trademark of Linear Corporation. Master Mechanic is a trademark of TruServ. Sears is a trademark of Sears & Roebuck. Stanley is a trademark of The Stanley Works. Wayne Dalton is a trademark of Wayne Dalton Corporation. Do It is a trademark of Do It Best Corporation. All other trademarks are the property of their respective owners.