



Cabinet Collection Guide

January, 2019

America's Best
Value in Cabinetry™

cnc cabinetry™

America's Ultimate Value in Cabinetry™

www.cnccabinetry.com



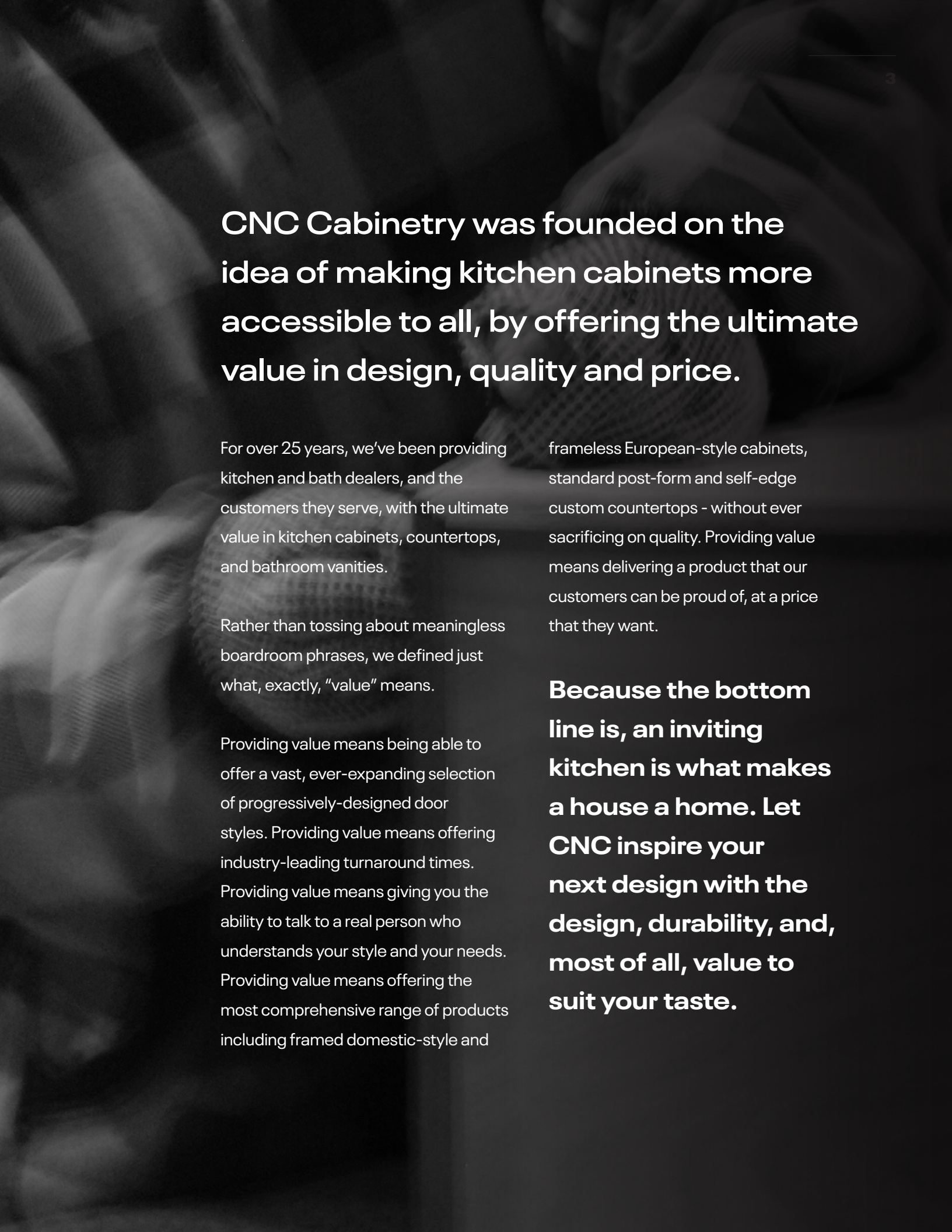

CNC Cabinetry was founded on the idea of making kitchen cabinets more accessible to all, by offering the ultimate value in design, quality and price.

For over 25 years, we've been providing kitchen and bath dealers, and the customers they serve, with the ultimate value in kitchen cabinets, countertops, and bathroom vanities.

Rather than tossing about meaningless boardroom phrases, we defined just what, exactly, "value" means.

Providing value means being able to offer a vast, ever-expanding selection of progressively-designed door styles. Providing value means offering industry-leading turnaround times.

Providing value means giving you the ability to talk to a real person who understands your style and your needs. Providing value means offering the most comprehensive range of products including framed domestic-style and

frameless European-style cabinets, standard post-form and self-edge custom countertops - without ever sacrificing on quality. Providing value means delivering a product that our customers can be proud of, at a price that they want.

Because the bottom line is, an inviting kitchen is what makes a house a home. Let CNC inspire your next design with the design, durability, and, most of all, value to suit your taste.

4



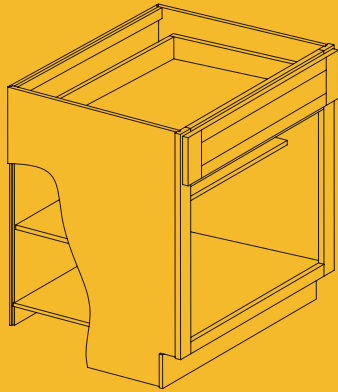

< Concord

The Concord series is our all-plywood line, which comes with full half-inch back panels, complete with solid wood dovetail drawers, enhanced by a soft-close feature and full extension under-mount glides to create a smooth glide. The cabinetry is equipped with $\frac{3}{4}$ " fully adjustable shelves, which provide supreme durability, and six-way adjustable soft close hinges for flexibility. Light-colored wood interiors allow for practicality and ease of maintenance.

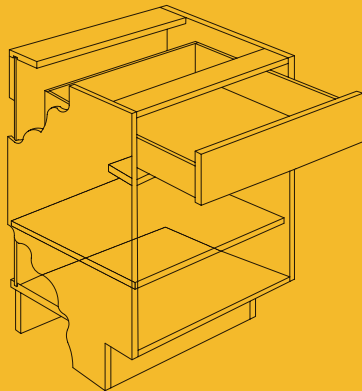

< Classic

The Classic series is composed of $\frac{3}{4}$ " vinyl laminated plywood with a frameless box construction. The metal drawers are outfitted with full extension, under-mount drawer glides, as well as the soft-close feature. The six-way adjustable soft close hinges, $\frac{3}{4}$ " adjustable full-depth plywood shelves, and dowel and glue-clamped assembly construction create a solid, durable framework for your cabinetry.

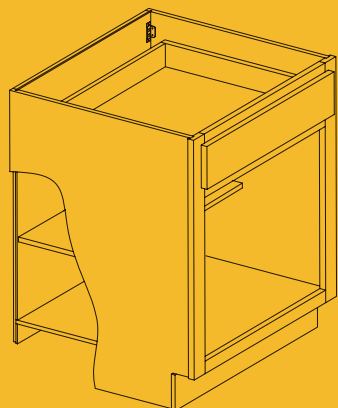

< Country

The Country series is constructed from all plywood cabinets and drawers. The wall and base cabinets are equipped with $\frac{3}{4}$ " plywood adjustable shelves and four-way adjustable hinges, reinforced for extra durability by a metal clip fastener assembly system.

Park Ave

Concord series

Overlay: Full Overlay

Panels: Raised Panels

Species: Birch









Park Avenue-the name itself signifies sophistication and elegance. Both the door and drawer front in this style is 5-piece miter constructed, with a full overlay. Furniture inspired, the Park Avenue door has the appearance of interior moldings. Together, they will attract anyone looking for a richly crafted door, at an affordable price.



White PB10



Ocean Blue PB21



Cinnamon PB06

Elegant

Concord series

Overlay: Full Overlay

Panels: Shaker

Species: Birch









Perfect for either traditional or contemporary décor, Elegant cabinets feature a wide shaker style and full overlay. In addition, the reversed, raised center panel on the doors add a blend of strength and character, seasoned with a noticeable charm and elegance.



White EB10



Dove EB22



Cinnamon EB06

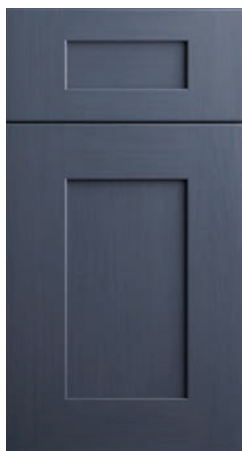

Ocean Blue EB21



Nutmeg EB9

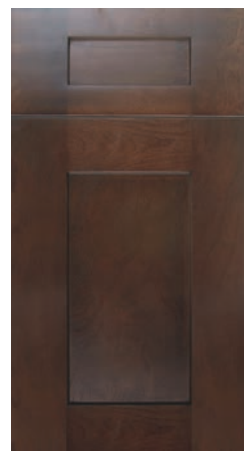

Espresso EB11

14



Victoria

Concord series

Overlay: Full Overlay

Panels: Coved Shaker

Species: Birch



The name speaks for itself. The Victoria line merges both a contemporary, clean look with a classic style. The miter door frame is built with a semi-pillow effect, sharply beveled toward the center panel. As a reversed-raised panel, this frame is durable enough to withstand even the busiest of kitchens. Made of birch, this cabinet is sure to fit into any style and décor, providing the look you desire in any home.



VB10 White



VB22 Dove

Harmony

Concord series

Overlay: Full Overlay

Panels: Raised Panels

Species: Birch





Harmony is a full overlay, mitered raised panel Birch door exquisitely accented with an angled interior molding. Available in two finishes inspired by today's interior design experts. A richly crafted door at an affordable price.



Pearl Mocha HB13M



Pearl HB13

Fashion

Concord series

Overlay: Full Overlay
Panels: Shaker
Species: Birch



This full overlay, Shaker-inspired birch door comes with a beautiful accent molding wrapped around the flat center panel. The door is built using a reversed raised panel that is very sturdy and very durable. Available in four finish options. A cabinet door at an affordable price.



Pearl FB13



White FB10



Ocean Blue FB21



Dove FB22





Alexandria

Concord series

Overlay: Full Overlay

Panels: Recessed Panels

Species: Birch



As attractive as it is versatile, the Alexandria door reinterprets classic style by combining the character and craftsmanship of yesterday with the clean, modern styling of today. The mitered styling, with its flat center, panels will surely create the attractive, high-end look for your kitchen you've always imagined.



Espresso AB11



Pearl Chocolate glaze
AB13C



Pearl Mocha glaze
AB13M



Pearl AB13

Bristol

Concord series

Overlay: Full Overlay

Panels: Raised Panel

Species: Birch



With all of the allure of an American classic, the Bristol design remains a symbol of distinction and grace. Bristol cabinetry represents the pinnacle in the fusion of cabinet design and fine wood. This traditional design is enhanced with a raised center panel not just on the doors but on the drawers as well, creating a casual early American feel.



Toffee C8



Toffee Glaze C8B

Matrix

Classic Series

Overlay: Full Overlay

Panels: Slab

Species: Textured Laminate



Today's contemporary design trends focus heavily on the depth & colors of real wood. Matrix gives you that richness, but with a longer lifespan. Available in 4 stocked colors, let Matrix bring your modern designs to life.



Silver M18

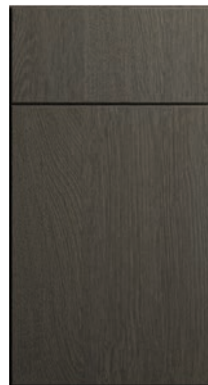

Greystone M19

Oxford

Concord series

Overlay: Full Overlay

Panels: Shaker

Species: Textured Laminate



Oxford is a sophisticated, classic Shaker door style available on our Classic series full access, frameless box. This durable, easy-to-maintain door has a textured feel that simulates real wood, without the imperfections. Oxford is stylish, and precise at a very affordable price with all the added features you expect.



Silver 018



Greystone 019



Milano

Classi series

Overlay: Full Overlay

Panels: Slab

Species: Thermofoil



This full overlay, contemporary style slab door is very versatile. Available in a high gloss finish that looks very trendy in a kitchen setting, and it is easy to clean and durable enough for the laundry room. It is available on our award winning Classic frameless box, including plywood sides and a metal soft close drawer, at no additional cost.

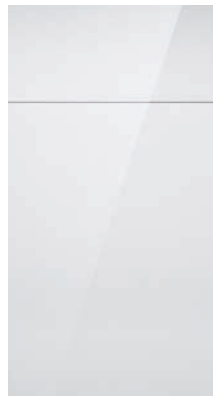

White M14

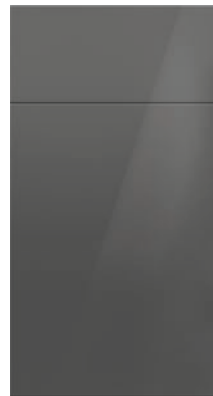

Slate M15

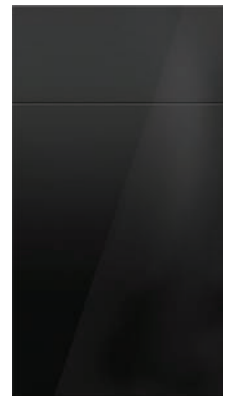

Ebony M16



Sydney

Classic series

Modern, sleek, with a square, flat panel, these white satin cabinets imbue the room with a sense of twenty-first century style and in vogue look. Without the interruption of frames, center stiles, and rails, the Sydney door provides a smart and spacious effect. Includes plywood sides and a metal soft close drawer, at no additional cost.

Overlay: Full Overlay

Panels: Shaker

Species: Thermofoil



White ST10







Cascade

Classic series

This white satin cabinetry brightens any room. Made of thermofoil with a square, raised panel and frameless box, Cascade cabinets brighten any room. Uninterrupted by frames, center stiles, and rails, this white satin cabinetry conveys a clean, flowing look that integrates perfectly with its surroundings. Includes plywood sides and a metal soft-close drawer, available at no additional cost.

Overlay: Full Overlay

Panels: Raised Panels

Species: Thermofoil



White CT10

Luxor

Country Series

Overlay: Standard Reveal

Panels: Shaker

Species: Birch



Perfect for either traditional or contemporary décor, Luxor cabinets feature a wide shaker style and partial overlay, providing the charm and elegance you desire. Available in White, Smoky Grey, Cinnamon and Espresso finishes.



Smoky Grey L02



Cinnamon L06



White L10



Espresso L11





Sierra

Country series

Overlay: Standard Reveal

Panels: Raised Panels

Species: Birch



This standard-reveal, raised panel, birch door comes in our value-priced Country series. Available in three inspiring finishes, Toffee, Nutmeg and Espresso, Sierra provides you with an expensive-looking finish at an affordable price.



Toffee S8



Nutmeg S9



Espresso S11



Country Oak

Country series

This solid oak cabinet combines traditional style with lasting quality. A practical, light wood finish coats the interior of the cabinets, while the exterior is tinted with a warm honey color. Country Oak's durability ensures these cabinets will be a lasting, charming fixture in your home for years to come.

Overlay: Standard Reveal

Panels: Raised Panel

Species: Oak



Oak C4

Post Form Countertops

CNC Associates offers a full range of post-form countertops in a multitude of colors. With our state-of-the-art production plant, CNC Associates can fulfill all your needs. We produce both large and small quantity orders with quick turnaround, at the most competitive prices.

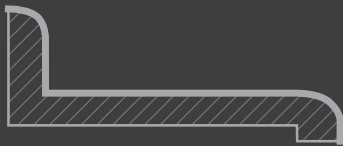

Crescent

A high quality profile countertop edged with a 90 degree radius on its front edge, Crescent is one of our most popular post form countertop designs and can be easily installed in today's economical homes.

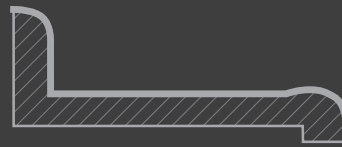

Pluto

A very durable countertop, finished with a 90 degree front edge. The raised front edge with an additional, no-drip bump conveniently prevents spillage. Pluto is made with water resistant plywood that will protect your countertop for years to come.



204-58 / BUTCHER BLOCK MAPLE

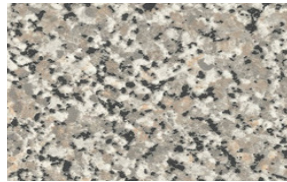

4550-01 / GRANITE



1573-60 / WHITE

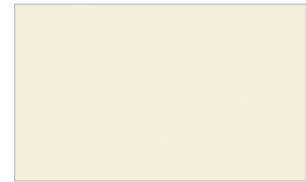

D30-60 / ALMOND



4925K-07 / CALCUTTA MARBLE

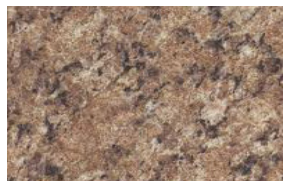

4724-52 / MILANO AMBER

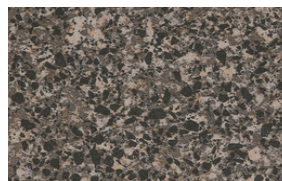

4551-01 / BLACKSTAR GRANITE

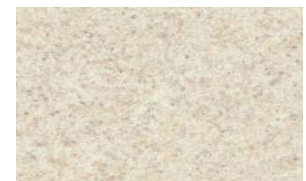

4762-60 / MYSTIQUE DAWN



7732-58 / BUTTERUM GRANITE



4726-52 / MILANO QUARTZ

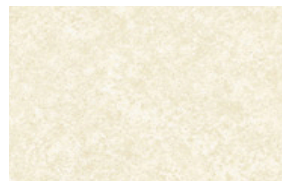

4166-60 / PAMPAS





Self Edge Countertops

CNC Cabinetry has the resources to produce custom self edge countertops in our extensive manufacturing facility. With customization options such as wood edge and bevel treatment, radius corners and template countertops, and many more options, we can satisfy all of your innovative kitchen designs. CNC's custom self-edge countertops are produced with the most efficient turnaround possible, while still maintaining competitive prices.

See our specbook for available colors





Our many design options allow you to choose your own accessories for a unique, customized look. You can double and triple stack crown moldings to create a distinctive ornamentation, try organizing your kitchen with unique cabinet storage and wire racking, or utilize glass doors with wine and plate racks to add diversity and definition. With options to bring out your personal style, and offering the fastest turnaround possible at competitive pricing, CNC Cabinetry is the clear choice for your home design needs.

Five Year Limited Warranty

CNC Cabinetry Inc. warrants to the original purchaser that all Concord, Country and Classic Collection Cabinetry will be free from defects in material and workmanship under normal use for five years from the time of purchase.

During this period of time, CNC Cabinetry Inc. will repair or replace at our option, any cabinet or component that proves to be defective in material and workmanship under proper installation and normal use. This warranty does not apply to any damage that has occurred due to normal wear, accident, misuse, or improper handling of the cabinetry. Cabinetry that is stored or placed in humid environment will not be covered under this warranty. This warranty does not apply to cabinetry that has been altered, modified, improperly installed or serviced by any unauthorized service agency. This warranty is limited to the replacement of defective parts only and does not include service, labor, or transportation charges

related to the removal or installation of the defective or replacement parts. This warranty does not apply to any products used in conjunction with the cabinetry, such as counter tops, appliances, or plumbing fixtures. Repair or replacement are subject to the current product offerings of styles and construction of CNC Cabinetry Inc. at that time. If a warranty claim is filed after a product becomes unavailable, CNC Cabinetry Inc. will replace that part with a part of the same or similar style based on availability. No dealer, agent, contractor, or installer has any right to change or extend the above warranty.

These warranty statements only, are the expressed warranties extended by CNC Cabinetry Inc. In lieu of any other warranties, this warranty shall constitute the entire liability of CNC Cabinetry Inc. All styles, finishes, hardware and specifications are also subject to change without prior notice.



Warehouse

303 Helen Street
South Plainfield, NJ 07080

Florida Warehouse

4501 Homerun Blvd. # 300
Davenport, Florida 33837



Headquarters

101 Kentile Road
South Plainfield, NJ 07080





Member

NKBA

— www.cnccabinetry.com

**America's
Best Value
In Cabinetry™**

www.cnccabinetry.com



Headquarters

101 Kentile Road
South Plainfield, NJ 07080

Florida Warehouse

4501 Homerun Blvd. # 300
Davenport, Florida 33837

T. 718-416-3853

F. 718-416-4077