

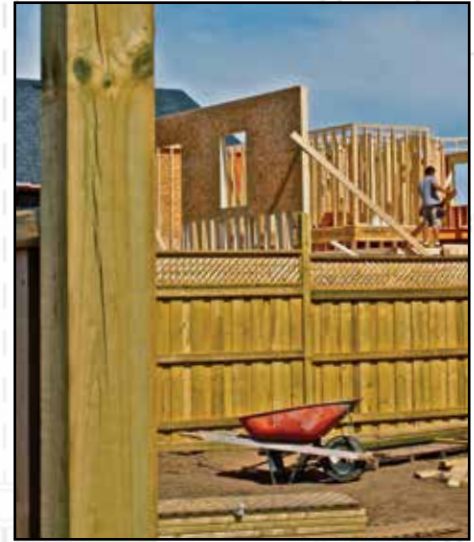

**Pro Solutions Designed to  
Fit into Every Project Plan.**



For more information, please visit the specialty website listed:



[www.grkfasteners.com](http://www.grkfasteners.com)



[www.redheadanchoring.com](http://www.redheadanchoring.com)



[www.tapcon.com](http://www.tapcon.com)



[www.ramset.com](http://www.ramset.com)



[www.backeronrockon.com](http://www.backeronrockon.com)

## Table of Contents

---

<b>SECTION 1:</b> <i>R4™ MULTI-PURPOSE FRAMING &amp; DECKING SCREWS</i>	4-5	<b>SECTION 9:</b> <i>TAPCON® CONCRETE SCREW ANCHORS</i>	20-21
<b>SECTION 2:</b> <i>RSS™ RUGGED STRUCTURAL SCREWS</i>	6-7	<b>SECTION 10:</b> <i>TAPCON+® CONCRETE SCREW ANCHORS TRUBOLT® CONCRETE WEDGE ANCHORS</i>	22-23
<b>SECTION 3:</b> <i>FIN/TRIM™ TRIM HEAD SCREWS</i>	8-9	<b>SECTION 11:</b> <i>RED HEAD® CONCRETE ANCHORS RED HEAD® A7+ ADHESIVE ANCHORS</i>	24-25
<b>SECTION 4:</b> <i>RT COMPOSITE™ TRIM HEAD SCREWS</i>	10-11	<b>SECTION 12:</b> <i>RAMSET® P.A.T. TOOLS &amp; ACCESSORIES</i>	26-27
<b>SECTION 5:</b> <i>PHEINOX™ STAINLESS STEEL SCREWS - 305 Stainless - 316 Marine Grade Stainless</i>	12-13	<b>SECTION 13:</b> <i>TEKS® METAL FASTENING SCREWS</i>	28-29
<b>SECTION 6:</b> <i>LOW PROFILE CABINET™ SCREWS</i>	14-15	<b>SECTION 14:</b> <i>CEMENT BOARD SCREWS, CBS STAR DRIVE BITS &amp; ACCESSORIES</i>	30-31
<b>SECTION 7:</b> <i>CALIBURN™ CONCRETE SCREWS TOP STAR™ SHIM SCREWS</i>	16-17	<b>SECTION 15:</b> <i>MERCHANDISERS &amp; DISPLAYS FASTENER TECHNICAL DATA</i>	32-41
<b>SECTION 8:</b> <i>MSS™ METAL SIDING SCREWS E-Z ANCHOR® MULTI-USE ANCHORS</i>	18-19	<b>SECTION 16:</b> <i>FASTENER TECHNICAL BULLETIN</i>	42-50



GRK's R4™ self-countersinking screw has a patented underhead with saw-blade like cutting teeth and six self-contained cutting pockets. Together they act similar to a circular saw-blade, transporting the drill dust away from the edge of the screw hole while cutting a perfectly clean hole into even the most brittle materials without cracking any surface treatment.

This design enhances the R4™'s versatility by allowing the fastener to countersink into even the hardest woods. The head of the screw closes the hole off with precision, leaving no damaged fibers around the head.

R4™ screws 3-1/8" and longer have a four threaded CEE Thread. This enlarges the screw hole for the non-threaded portion of the fastener, allowing the wood to settle easily. It increases the screw's drawing strength and reduces the friction on the screw shank that lowers the driving torque.

**GRK**  
FASTENERS™

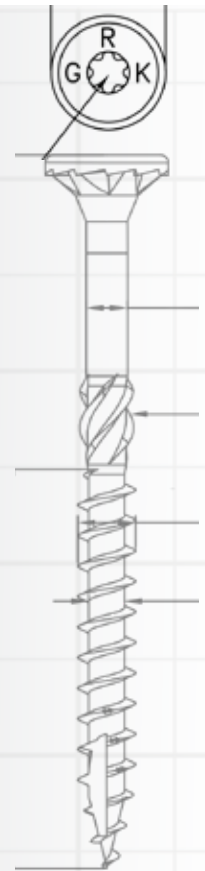

## R4™ MULTI-PURPOSE FRAMING & DECKING SCREWS

Faster Drive for Improved Productivity



AC257 Treated Lumber Approved

- **Fast Bite Tip:** Eliminates pre-drilling and provides a fast start for one-step installation.
- **W-Cut™:** Low torque, faster drive.
- **Precision Fit:** Reduces wobble between R4 screws and GRK bits for improved productivity.
- **Star Drive:** Zero stripping, with 6 points of contact.
- **Optimized Thread Length:** Improves clamping force for increased drawing power.
- **CEE Thread:** Enlarges hole to reduce splitting.
- **Cutting Teeth:** Cuts wood fiber & provides flush seating.
- **GRK Head Markings:** Easy identification of genuine GRK screws.
- **ESR-3201 Approved** for structural applications.
- **Climatek™ Coating is AC257 code approved** for use in treated lumber.
- For interior / exterior use in; wood, plastic, cement fiber board, particle board, sheet metal, wood decking and melamine.
- Also available in **PHEINOX™** 305 and 316 grade Stainless Steel.

	U.S. (Std.) Size (Dia. x Length)	Bulk Part No.	Bulk Box Qty.	Pro-Pak Part No.	Pro-Pak Pail Qty.	Handy-Pak Part No.	Handy-Pak MC Qty. / Screw Qty. (per EA)
T-15	#6 x 1-1/4"	00051†	13,000				
	#8 x 1-1/4"			01069†	1,300	02069†	20 / 100
T-15	#8 x 1-1/2"	00073†	6,500	01073†	1,000	02073†	20 / 100
	#8 x 1-3/4"			01075†	925	02075†	20 / 100
	#8 x 2"	00077	4,500	01077	850	02077	20 / 100
	#8 x 2-1/2"	00079	3,500	01079	650	02079	20 / 100
T-25	#9 x 1-1/4"	00091†	8,000				
	#9 x 1-1/2"	00095†	5,200	01095†	820	02095†	20 / 100
	#9 x 1-3/4"	00097†	4,500				
	#9 x 2"	00099	3,700	01099	690	103099	4 / 110
	#9 x 2-1/2"	00101	2,900	01101	575	103101	4 / 110
	#9 x 2-3/4"	00103	2,000	01103	480	02103	10 / 100
	#9 x 3-1/8"	00105	1,900	01105	425	103105	4 / 80
T-25	#10 x 2"	00131	3,200				
	#10 x 2-1/2"	00133	2,500	01133	470	103133	4 / 80
	#10 x 2-3/4"	00135	2,000				
	#10 x 3-1/8"	00137	1,500	01137	350	103137	4 / 70
	#10 x 3-1/2"	00139	1,200	01139	300	02139	10 / 50
	#10 x 4"	00141	1,000	01141	270	103141	4 / 50
	#10 x 4-3/4"	00143	800	01143	230	02143	10 / 50
T-25	#12/14 x 5-5/8"	00173	600			96089	4 / 50
	#12/14 x 6-3/8"	00177	1,000			02177	9 / 50
	#12/14 x 8"	00181	500			02181	9 / 50

R4™ CONTRACTOR PACKS ( XL BUCKETS )		
U.S. (std.)	Pt. No.	Quantity
#9 x 2"	120990	990
#9 x 2-1/2"	121010	900
#9 x 3-1/8"	121050	720
#10 x 3-1/8"	95200	630
#10 x 4"	121410	450



Some sizes available in **PHENOX™** hardened Stainless Steel; refer to Section 5. 2" bit included in Pro-Paks. 1" bit w/Handy-Paks. \*Does not come with the Zip-Tip™ feature. †Does not have the added CEE-THREAD™ feature.  
**NOTE:** Pro-Paks need to be ordered in multiples of two.

GRK's RSS™ screw is made of specially hardened steel to provide you with high tensile, torque and shear strength. The sharp threads and points bite instantly into the material (including hardwood), reducing the splitting effect due to smaller shanks.

RSS™ screws that are 3-1/8" and longer have CEE Threads which enlarge the screw hole for the non-threaded portion of the fastener, allowing the wood to settle easily and increases the screw's drawing strength. The CEE Thread also reduces the friction on the screw shank which can result in lowering the driving torque and the likelihood of splitting the wood. This is why the RSS™ screw is an efficient lag screw alternative.

Our round head with built-in shield (washer type head) has no sharp edges like conventional lag screws. The added shoulder (nominal diameter) underneath the washer has the ability to center the RSS™ screw in pre-drilled hardware like hinges and connector plates.

RSS™ JTS - Used for joists and trusses

**GRK**  
FASTENERS™



## RSS™ RUGGED STRUCTURAL SCREWS

Easy to Install Lag Alternative



- **Recessed Star Drive:** Zero Stripping, with 6 points of contact
- **CEE Thread:** Enlarges hole to reduce splitting
- **W-Cut™:** Low torque, faster drive
- **Zip-Tip™:** No pre-drilling, faster penetration
- **Washer Head:** for immense holding power
- **Cutting Pockets:** provide a clean hole and reduces splitting, and bore with precision.
- **ESR-2442 Approved** for structural application.
- **Case Hardened Steel:** for high tensile, torque and shear strength.
- **Climatek™ Coating is AC257** code approved for use in treated lumber.
- For interior / exterior use in; carrying beams, ledger boards, stair rails, deck posts, playground equipment and other professional applications.
- Also available in **PHEINOX™** 305 and 316 grade Stainless Steel.



AC257 Treated Lumber Approved





T-25

U.S. (Std.) Size (Dia. x Length)	Bulk Part No.	Bulk Box Qty.	Pro-Pak Part No.	Pro-Pak Pail Qty.	Handy-Pak Part No.	Handy-Pak MC Qty. / Screw Qty. (per EA)
#10 x 2-1/2"	<b>10133†</b>	1,000			<b>12133†</b>	10 / 50
#10 x 3-1/8"	<b>10137</b>	800	<b>11137</b>	236	<b>12137</b>	10 / 50



T-25

1/4" x 1-1/2"	<b>10151*†</b>	1,000			<b>12151*†</b>	20 / 50
1/4" x 2"	<b>10155*†</b>	800			<b>12155*†</b>	10 / 50
1/4" x 2-1/2"	<b>10157†</b>	700				
1/4" x 3-1/8"	<b>10161</b>	500			<b>12161</b>	10 / 50



T-30

5/16" x 2-1/2"	<b>10217†</b>	600			<b>12217†</b>	9 / 100
5/16" x 2-3/4"	<b>10219†</b>	500			<b>12219†</b>	2 / 100
5/16" x 3-1/8"	<b>10221</b>	500			<b>12221</b>	2 / 100
5/16" x 3-1/2"	<b>10223</b>	500			<b>12223</b>	2 / 100
5/16" x 4"	<b>10225</b>	400			<b>12225</b>	2 / 100
5/16" x 5-1/8"	<b>10231</b>	300			<b>12231</b>	9 / 50
5/16" x 6"	<b>10235</b>	300			<b>12235</b>	9 / 50



T-40

3/8" x 3-1/8"	<b>10273</b>	400				
3/8" x 4"	<b>10275</b>	400			<b>12275</b>	9 / 50
3/8" x 6"	<b>10281</b>	300			<b>12281</b>	2 / 50
3/8" x 7-1/4"	<b>10285</b>	200			<b>12285</b>	2 / 50
3/8" x 8"	<b>10287</b>	300			<b>12287</b>	2 / 50
3/8" x 10"	<b>10293</b>	300			<b>12293</b>	2 / 50
3/8" x 12"	<b>10299</b>	300			<b>12299</b>	2 / 50
3/8" x 14-1/8"					<b>12307</b>	2 / 50
3/8" x 16"	<b>10311</b>	100			<b>12311</b>	2 / 50

### RSS™ JTS - JOIST AND TRUSS SCREW



T-25

1/4" x 5"					<b>93735</b>	9 / 50
1/4" x 6-3/4"	<b>91743</b>	300			<b>93743</b>	9 / 50

### RSS™ MINI HANDY-PAK

U.S. (std.)	Pt. No.	MC Qty./ Screw Qty.
5/16" x 3-1/8"	<b>14221</b>	10 / 25
5/16" x 4"	<b>14225</b>	10 / 25
5/16" x 5-1/8"	<b>14231</b>	10 / 20
5/16" x 6"	<b>14235</b>	10 / 20

### RSS™ INDIVIDUALLY TAGGED

U.S. (std.)	Pt. No.	Qty./ Ctn.
5/16" x 3-1/8"	<b>96001</b>	1/50
5/16" x 4"	<b>96005</b>	1/50
5/16" x 5-1/8"	<b>96010</b>	1/50
5/16" x 6"	<b>96015</b>	1/40
3/8" x 8"	<b>96020</b>	1/25
3/8" x 10"	<b>96025</b>	1/25
3/8" x 12"	<b>96030</b>	1/20

Some sizes available in **PHEINOX™** hardened Stainless Steel; refer to Section 5.

**NOTE:** Pro-Paks need to be ordered in multiples of two. \*Does not come with the Zip-Tip™ feature.

†Does not have the added CEE-THREAD™ feature. 2" bit included in Pro-Paks. 1" bit with Handy-Paks.

GRK's Trim™ Head screws are an excellent choice for most fine carpentry applications, as well as window extension jambs, joining cabinets and more. Our Trim™ Head screws have the smallest screw head available; with screw lengths from 1-1/4" (30 mm) to 5" (125 mm).

Most material splitting is prevented because of the Trim™ Head screw's exceptionally small head and the W-Cut thread design.

Fin/Trim™ screws are also available in white finish to blend in with white wooden trim boards.





## FIN/TRIM™ FINISHING TRIM HEAD SCREWS

Install Right the First Time



- **Recessed Star Drive:** Zero Stripping, with 6 points of contact.
- **Trim Head:** for a clean finished look.
- **W-Cut™:** Low torque, faster drive.
- **Zip-Tip™:** No pre-drilling, faster penetration.
- **ESR-3201 Approved** for structural application.
- **Case Hardened Steel:** for high tensile, torque and shear strength.
- **Climatek™ Coating is AC257** code approved for use in treated lumber.
- For interior / exterior use.
- Available in **Climatek™** or white finish.
- Also available in **PHEINOX™** 305 and 316 grade Stainless Steel.



	U.S. (Std.) Size (Dia. x Length)	Bulk Part No.	Bulk Box Qty.	Pro-Pak Part No.	Pro-Pak Pail Qty.	Handy-Pak Part No.	Handy-Pak MC Qty. / Screw Qty. ( per EA )
 T-10	#8 x 1-1/4"					<b>17720</b>	20 / 100
	#8 x 1-1/2"	<b>15724</b>	6,500	<b>16724</b>	915	<b>17724</b>	20 / 100
	#8 x 2"	<b>15728</b>	4,500	<b>16728</b>	725	<b>17728</b>	20 / 100
	#8 x 2-1/2"	<b>15730</b>	3,500	<b>16730</b>	605	<b>17730</b>	20 / 100
	#8 x 2-3/4"					<b>17732</b>	20 / 100
	#8 x 3-1/8"	<b>15734</b>	2,500	<b>16734</b>	514	<b>17734</b>	10 / 100
 T-15	#9 x 4"	<b>15760</b>	1,000			<b>17760</b>	10 / 50
	#9 x 5"	<b>15766</b>	800			<b>17766</b>	10 / 50
<b>WHITE FIN / TRIM™</b>							
 T-10	#8 x 2"			<b>16828</b>	605	<b>17828</b>	20 / 100
	#8 x 2-1/2"			<b>16830</b>	505	<b>17830</b>	20 / 100

Some sizes available in **PHEINOX™** hardened Stainless Steel; refer to Section 5

**NOTE:** Pro-Paks need to be ordered in multiples of two. 2" bit included in Pro-Paks. 1" bit with Handy-Paks.

**Excellent for all of  
your trimwork and fine  
carpentry finishing.**



GRK has modified its innovative FIN/Trim™ Head screw to include reverse threading under the head of the fastener. This technology makes the RT Composite™ Trim Screw ideal for use in composite and cellular PVC trim.

Based on extensive tests, GRK has found that the reverse thread helps the screw head disappear beneath the surface of the classic wood composite material, reducing or eliminating the dimple that sometimes appears when using the FIN/Trim™ screw.

The reverse thread feature is available in RT Composite™ screws from 2" to 3-1/8" in length in both regular Climatek™ coating and in white Climatek™ coated finish to blend in with popular white exterior composite and cellular PVC trim.

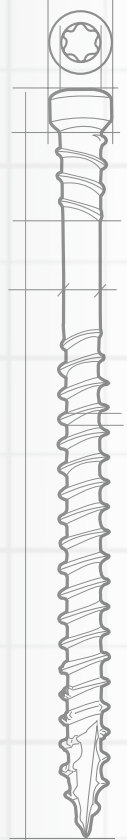

## RT COMPOSITE™ EXTERIOR TRIM SCREWS

Install Right the First Time





- **Recessed Star Drive:** Zero Stripping, with 6 points of contact.
- **Reverse Threads** eliminate mushrooming.
- **Trim Head:** for a clean finished look.
- **W-Cut™:** Low torque, faster drive.
- **Zip-Tip™:** No pre-drilling, faster penetration.
- **ESR-3201 Approved** for structural application.
- **Case Hardened Steel:** for high tensile, torque and shear strength.
- **Climatek™ Coating is AC257** code approved for use in treated lumber.
- For interior / exterior use in; exterior PVC trim (Azek,™ Klear,™ Koma™), no pre-drilling is necessary. Climatek™ coated screws work well with CAMO system.
- Available in **Climatek™** or white Climatek™ coated finish.
- Also available in **PHEINOX™** 305 and 316 grade Stainless Steel.



AC257 Treated Lumber Approved



	U.S. (Std.) Size (Dia. x Length)	Bulk Part No.	Bulk Box Qty.	Pro-Pak Part No.	Pro-Pak Pail Qty.	Handy-Pak Part No.	Handy-Pak MC Qty. / Screw Qty. (per EA)
 T-10	#8 x 2"			<b>16077</b>	725	<b>17077</b>	20 / 100
	#8 x 2-1/2"	<b>15079</b>	3,500	<b>16079</b>	605	<b>17079</b>	20 / 100
	#8 x 3-1/8"	<b>15083</b>	2,500	<b>16083</b>	514	<b>17083</b>	10 / 100
 T-15	#9 x 2-1/2"	<b>15101</b>	2,900	<b>16101</b>	408		
	#9 x 3-1/8"	<b>15105</b>	1,900	<b>16105</b>	348		
<b>WHITE RT COMPOSITE™</b>							
 T-10	#8 x 2"			<b>16628</b>	605	<b>17628</b>	20 / 100
	#8 x 2-1/2"			<b>16630</b>	505	<b>17630</b>	20 / 100
	#8 x 2-3/4"					<b>17632</b>	20 / 100
	#8 x 3-1/8"					<b>17634</b>	10 / 100

Some sizes available in **PHEINOX™** hardened Stainless Steel; refer to Section 5.

**NOTE:** Pro-Paks need to be ordered in multiples of two. 2" bit included in Pro-Paks. 1" bit with Handy-Paks.

**Supreme Drawing Power**  
is perfect for trimwork and  
deck construction.





**305 STAINLESS STEEL**  
Corrosion Resistance for Harsh Environments



**316 STAINLESS STEEL**  
Marine Grade Protection for Superior Corrosion Resistance

# PHEINOX™ STAINLESS STEEL SCREWS

PHEINOX™ 305 Stainless Steel screws are corrosion and stain resistant fasteners designed to withstand wet environments. PHEINOX™ 316 Stainless Steel screws are designed for coastal applications. GRK's patented R4, RSS, FIN/TRIM and RT composite screws are available in PHEINOX™ stainless steel.

GRK recommends PHEINOX™ 305 stainless steels screws for applications that require superior corrosion resistance in wet environments such as decks, boardwalks, pools, and hot tubs. PHEINOX™ 305 stainless is also recommended for use with cedar, red-wood and various other wood substrates that have higher acid content as well as for composite deck boards. PHEINOX™ 305 stainless steels screws are recommended for applications located more than 1 mile from the coast.

PHEINOX™ 316 stainless steels screws are recommended for applications exposed to salt water or located within 1 mile of the salt water shoreline.

The Zip-Tip™ feature of the screw allows a faster start and eliminates the need for pre-drilling. Hardened stainless steel provides superior strength and unmatched performance by maximizing torque and increasing bending yield.











**AC257 Treated Lumber Approved**



Applies to 305 stainless only



PHEINOX™ 305	PHEINOX™ 316 
<ul style="list-style-type: none"> <li>• For use in cedar, redwood and specialty hardwood</li> <li>• Corrosion resistance for harsh environments</li> <li>• Corrosion resistance for wet environments</li> <li>• Stain resistant in specialty wood</li> </ul>	<ul style="list-style-type: none"> <li>• For use within 1 mile of the coast</li> <li>• Marine-Grade protection for Superior corrosion resistance</li> <li>• Superior Corrosion resistance for coastal environments</li> <li>• Stain resistant in specialty wood</li> </ul>

	U.S. (Std.)Size (Dia.x Length)	Bulk Part No.	Bulk Box Qty.	Pro-Pak Part No.	Pro-Pak Pail Qty.	Handy-Pak Part No.	Handy-Pak MC Qty. / Screw Qty. (per EA)
	<b>R4™ SCREWS : PHEINOX™ 305</b>						
 T-25	#10 x 2-1/2" #10 x 2-3/4" #10 x 3-1/8" #10 x 4"	<b>25133</b>	2,500	<b>26133</b>	425	<b>27133</b>	10 / 100
		<b>25137</b>	1,500	<b>26137</b>	305	<b>27137</b>	10 / 100
	<b>RSS™ SCREWS: PHEINOX™ 305</b>						
 T-30	5/16" x 3-1/8" 5/16" x 4" 5/16" x 6"	<b>30221</b> <b>30225</b> <b>30235</b>	500 400 300			<b>32225</b>	2 / 100
	<b>RT COMPOSITE™ TRIM SCREWS: PHEINOX™ 305</b>						
 T-10	#8 x 2" #8 x 2-1/2" #9 x 2-1/2"	<b>35079</b>	3,500	<b>36077</b> <b>36079</b> <b>36101</b>	600 560 365	<b>37079</b>	20 / 100
 T-10	#8 x 2" White Hd.	<b>35628</b>	4,500				
	<b>FIN / TRIM™ SCREWS: PHEINOX™ 305</b>						
 T-10	#8 x 1-1/2" #8 x 2" #8 x 2-1/2" #8 x 3-1/8"			<b>36728</b> <b>36730</b> <b>36734</b>	600 560 385	<b>37724</b> <b>37728</b> <b>37730</b> <b>37734</b>	20 / 100 20 / 100 20 / 100 10 / 100
 T-15	#9 x 2-1/2"			<b>36752</b>	365		
	<b>R4™ SCREWS: PHEINOX™ 316</b>						
 T-25	#10 x 2-1/2" #10 x 3-1/8"					<b>37133</b> <b>37137</b>	10 / 100 10 / 100
	<b>FIN / TRIM™ SCREWS: PHEINOX™ 316</b>						
 T-10	#8 x 2-1/2"					<b>47730</b>	20 / 100

2" bit included in Pro-Paks. 1" bit with Handy-Paks. \*Does not come with the Zip-Tip™ feature.  
†Does not have the added CEE-THREAD™ feature.



GRK's Cabinet™ screws are designed specifically for use in cabinet construction and installation. Cabinet™ screws are manufactured in a #8 gauge (4 mm) diameter for universal size convenience.

These screws are thin enough to prevent most material splitting, while providing sufficient strength to guarantee a secure installation. The washer head design presses flush against any material surface.

The Cabinet screw can also be used for light duty framing applications where a smaller diameter shank is necessary, yet a need exists for drawing power delivered by the washer head.

White Cabinet Screws match perfectly with white cabinet frames without the need of sticker covers. Specialized Powder Coated heads will not chip while being driven in, allowing for a clean finish. They are ideally suited for a wide variety of interior applications including, closets & garage organizational systems.

**GRK**  
FASTENERS™

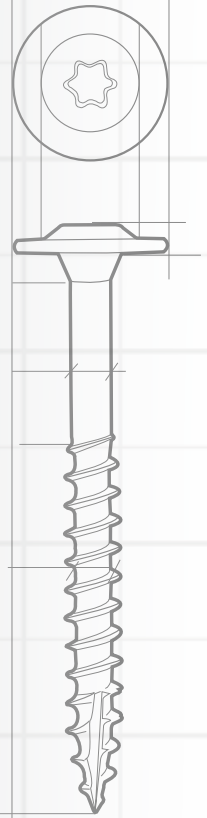

## LOW PROFILE CABINET™ SCREWS

Quick and Secure Installation



**AC257 Treated  
Lumber Approved**

- **Recessed Star Drive:** Zero Stripping, with 6 points of contact.
- **Washer Head:** Creates a flush, clean hold for a strong and secure installation.
- **W-Cut™:** Low torque, faster drive.
- **Zip-Tip™:** No pre-drilling, faster penetration.
- **Case Hardened Steel:** for high tensile, torque and shear strength.
- **Climatek™ Coating is AC257 code approved** for use in treated lumber.
- For interior / exterior use.
- **White Cabinet Screw:** For interior use only.



T-15

U.S. (Std.)Size (Dia.x Length)	Bulk Part No.	Bulk Box Qty.	Pro-Pak Part No.	Pro-Pak Pail Qty.	Handy-Pak Part No.	Handy-Pak MC Qty. / Screw Qty. (per EA)
#8 x 1-1/4"	<b>10069</b>	4,000	<b>11069</b>	1085	<b>12069</b>	20 / 100
#8 x 1-1/2"	<b>10073</b>	3,000	<b>11073</b>	930	<b>12073</b>	10 / 100
#8 x 1-3/4"	<b>10075</b>	2,000			<b>12075</b>	10 / 100
#8 x 2"	<b>10077</b>	2,000	<b>11077</b>	650	<b>12077</b>	10 / 100
#8 x 2-1/2"	<b>10079</b>	1,500	<b>11079</b>	563	<b>12079</b>	10 / 100
#8 x 2-3/4"					<b>12081</b>	10 / 100
#8 x 3-1/8"	<b>10083</b>	1,000	<b>11083</b>	400	<b>12083</b>	10 / 50

### WHITE LOW PROFILE™ CABINET SCREWS



T-15

#8 x 1-1/4"					<b>120680</b>	6 / 80
#8 x 1-1/2"					<b>120670</b>	6 / 80
#8 x 2-1/2"					<b>120660</b>	6 / 80

**NOTE:** Pro-Paks need to be ordered in multiples of two. 2" bit included in Pro-Paks.

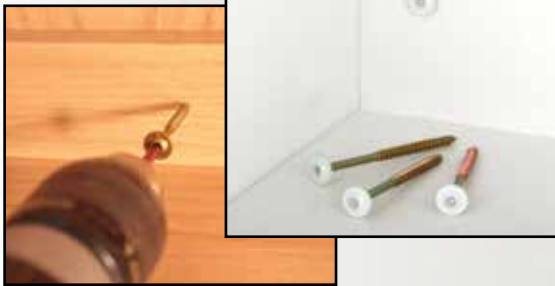

**Ideal for Cabinets...  
and so much more.  
Also excellent for a  
variety of interior or  
exterior jobs.**



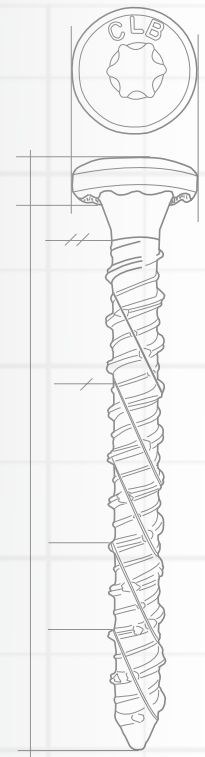

Cailburn™ Concrete screws are professionally engineered fasteners with a patented thread design for ease of driving the screw in concrete and similar applications.

- **Recessed Star Drive:** Zero Stripping, with 6 points of contact.
- **Aggressive Heavy duty threads** lock into concrete and can be removed and reinserted without screw damage.
- **ESR-3251** approved for use in anchoring into concrete.
- **Countersinking Bugle Head** locks wood to concrete for complete installation and effective anchoring.
- **Caliburn™ PH** pan head, which is ideal for an exposed finished look including installation of electrical boxes.
- **Caliburn™ XL** washer head design for superior holding power.
- **Climatek™ Coating is AC257** code approved for use in treated lumber.
- Ideal for use in anchoring to concrete or wood to concrete applications including basement framing and sheds.



# CALIBURN™ CONCRETE SCREWS

## Heavy Duty Concrete and Masonry Fastener

U.S. (Std.) Size (Dia. x Length)	Bulk Part No.	Bulk Box Qty.	Pro-Pak Part No.	Pro-Pak Pail Qty.	Handy-Pak Part No.	Handy-Pak MC Qty. / Screw Qty. (per EA)
 T-30 1/4" x 1-3/4" 1/4" x 2-1/4" 1/4" x 2-3/4" 1/4" x 3-1/2" 1/4" x 5"	55159	1,000	N/A	N/A	57153	10 / 50
					57156	10 / 50
					57159	10 / 50
					57163	10 / 50
					57171	10 / 50
<b>CALIBURN™ PH</b>						
 T-30 1/4" x 1-3/4" 1/4" x 2-1/4"			N/A	N/A	57828	10 / 50
					57831	10 / 50
<b>CALIBURN™ XL</b>						
 T-40 19/64" x 2-3/4" 19/64" x 3-1/2" 19/64" x 5"	55778	400	N/A	N/A	57774	10 / 25
					57778	10 / 25
					57785	10 / 25

1" bit included in Handy-Paks



**AC257 Treated Lumber Approved**



GRK's adjustable Top Star™ shim screw, is in fact a screw within a screw that allows you to install wooden doors or windows without the use of shims.

The quick and easy system reduces labor and allows for hassle free adjustment to ensure plumb installation.

- **Recessed Star Drive:** Zero Stripping, with 6 points of contact
- **4-point 3/8" diameter Threaded Sleeve** provides a secure hold in your wooden frame
- **Micro-Adjustments** allow for an absolutely plumb installation
- **Use with GRK's Top Star™ Crown and T-15 Star bit system.**
- **White Zinc Plated** finish for lasting durability.
- **For Shim Free installation** of wooden doors, windows, insulation, paneling, built-in wall units and cabinets.

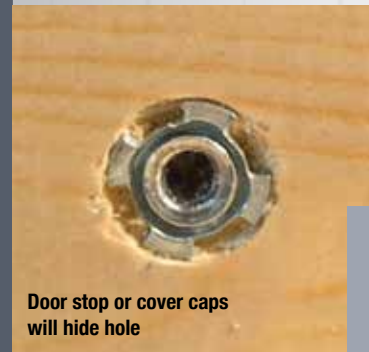
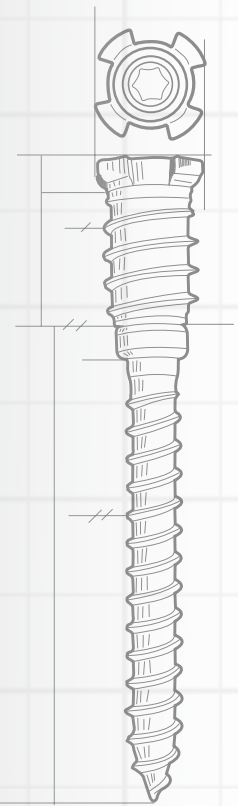

# TOP STAR™ ADJUSTABLE SHIM SCREWS

For Plumb Installation of Wooden Doors and Windows. No More Shims!

**The Complete Top Star™ System Includes:**

**BIT                      CROWN                      THREADED SLEEVE**



U.S. (Std.) Size (Dia. x Length)	Pro-Pak Part No.	Pro-Pak Box Qty.
3/8" x 2-1/2"	<b>20157</b>	100
3/8" x 3-1/8"	<b>20161</b>	100

**NOTE:** Pro-Paks need to be ordered in multiples of two.

*The Bit drives the Top Star™ into the material when the Crown and Bit are combined. Using the Bit without the Crown adjusts the distance.*

*The Threaded Sleeve moves independently from the Top Star™ unless locked by the Crown. When locked, the Top Star™ gets driven into the material.*

CROWN / BIT	Blister-Pak Part No.	Blister-Pak/Qty
 Includes: (1) Crown / Bit with each	<b>86465</b>	1

**NOTE:** Crown and Star bit system included in each bulk box. 5/16" drill bit not included.

*Unlocked, the installed Top Star™ is ready for levelling.*



The MSS™ was developed and patented based on the RSS™ model. This screw has an integrated washer-head and is complemented by a rubber washer below the screw head.

This feature also helps protect the washer from prolonged exposure to the sun for long lasting, secure siding installations.

- **White Color, Low Profile Head** produces a clean, finished look which is preferred for moldings, closet organizers and metal siding.
- **Washer Head** increases holding power.
- **Rubber Washer** seals drill hole from the elements.
- **W-Cut™ Thread Design** tiny saw blades reduce torque by cutting through the material.
- **ZIP-TIP™** for easy starts and no pre-drilling.
- For use in interior or exterior applications including metal siding, garage door trim and even closet organizers. Not for use with treated lumber.

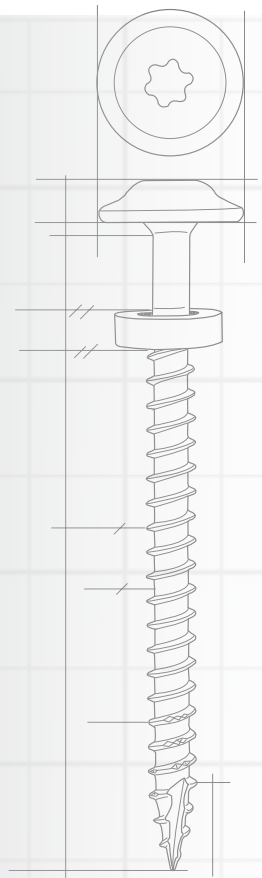

## MSS™ METAL SIDING SCREWS

Integrated Head Design with Powder Coating Finish

U.S. (Std.) Size (Dia. x Length)	Bulk Part No.	Bulk Box Qty.	Pro-Pak Part No.	Pro-Pak Pail Qty.	Handy-Pak Part No.	Handy-Pak MC Qty. / Screw Qty. (per EA)
#9 x 1-1/2"	40090	3,000			44090	10 / 100



1" bit included in Handy-Paks



**Self-tapping screws with integrated washer head, for fastening metal siding to a wooden framed structures.**

E-Z Anchors® are ideal for hanging accessories, signs, fixtures, and shelving units on drywall. Designed to self-drill flush into drywall for easy and fast installations. No pre-drilling necessary. The threads are formed to provide increased stability and a secure hold.

**E-Z Anchor® Twist-N-Lock** is designed for light to medium-duty applications. The audible click provides confirmation of the anchor being firmly set. Threads cut deeply to resist pull-out and provide a secure hold.

**E-Z Anchor® Stud Solver** is designed for light to medium-duty applications. Installs anywhere on a wall, even if you hit a wood stud behind the drywall. Threads cut deeply to resist pull-out and provide a secure hold.

**E-Z Anchor® Toggle Lock** is designed for heavy-duty drywall applications. The superior 1-piece assembly prevents losing extra pieces behind the wall. The toggle bar swivels easily during assembly to provide a secure hold.

**Buildex® Stucco Anchor** is designed for light to medium-duty applications in stucco. The zinc plating is designed to be durable in exterior and interior applications. Kits include a drill bit for installation.

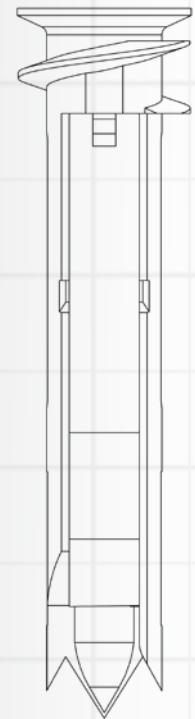

## E-Z Anchor® Multi-Use Anchors

### Heavy Duty Anchors for a Variety of Applications

U.S. (Std.) Size (Max Load)	Lg. Pack Part No.	Lg. Pack Qty.	Med. Pack Part No.	Med. Pack Qty.	Small Pack Part No.	Small Pack Qty.
<b>E-Z Anchor Twist-N-Lock Anchors</b>						
50 lbs.	25350	50	25200	25	11353	6
75 lbs.	25310	50	25210	20	11364	4
<b>E-Z Anchor Stud Solver Anchors</b>						
40 lbs.			25225	25	25125	4
50 lbs.	25316	50	25216	20	29503	5
<b>E-Z Anchor / E-Z Toggle Lock Anchor</b>						
100 lbs.	25320	25	25220	10	10006	2
<b>Buildex® Stucco Anchors</b>						
3/16" x 1-1/2" Hex Hd			31810	25	31710	4
3/16" x 1-1/2" Flat Hd			31820	25	31720	4
1/4" x 2-7/8"			31840	25	31740	4

- **No Pre-Drilling:** E-Z Anchor® Screws directly into drywall.
- **Self-Piercing Tip:** Provides smooth drive performance into drywall.
- **Flush Fit:** Installs flush against the wall to prevent items from wobbling.
- **Clean Finish:** Creates a small hole for easy installation, cleanup, and removal.
- **White Zinc Plated** finish for lasting durability.

**Warning:** Do not use Twist-N-Lock or Stud Solver anchors for ceiling applications. Do not use for mounting televisions. Load ratings are for items hung flush to the wall. Load ratings decrease when hanging items that project from the wall.

For decades, Tapcon products have enabled professionals to get their light to medium-duty concrete anchoring jobs done right the first time, every time. Designed to deliver 30% less torque and 20% more holding power, Tapcon anchors are the #1 choice of professionals.

Tapcon concrete screw anchors are designed to deliver superior holding power in all forms of masonry (concrete, CMU, and brick). The advanced WERCS threadform turns any anchoring job into a fast and easy process.

Offering everything from the anchors needed to fasten any fixture to concrete, to the drill bits that deliver a more precise hole and maximize holding power, to the Tapcon Pro Installation Kit that makes jobs faster and easier, Tapcon provides professionals with all the tools they need for confidence in a job done right.

**Tapcon**  
GENUINE Concrete Screw Anchors



## TAPCON® CONCRETE SCREW ANCHORS

Nothing Anchors Like Tapcon



- **Superior Holding Strength** for confidence in a job done right.
- **Corrosion-resistance and long-lasting performance** from the innovative Climaseal blue coating.
- **Advanced WERCS Threadform** reduces the installation torque & allows for use in a wider range of materials.
- **ICC-ES** approved for use in anchoring into concrete (ESR-2202).
- A long-standing reputation for quality, strength and ease of installation from industry professionals.

*With over one billion anchors sold, Tapcon concrete anchors deliver the ease of use, superior precision and unparalleled performance that professionals demand.*



U.S. (Std.) Size (Dia. x Length)	Bucket Part No.	Bucket Qty.	Lg. Clam Part No.	Lg. Clam Qty.	Med. Pack Part No.	Med. Pack Qty.	Sm. Pack Part No.	Sm. Pack Qty.
<b>PHILLIPS HEAD</b>								
3/16" x 1-1/4"	<b>24550</b>	225	<b>24350</b>	75	<b>24250</b>	25	<b>24150</b>	8
3/16" x 1-3/4"	<b>24555</b>	225	<b>24355</b>	75	<b>24255</b>	25	<b>24155</b>	8
3/16" x 2-1/4"	<b>24560</b>	225	<b>24360</b>	75	<b>24260</b>	25	<b>24160</b>	8
3/16" x 2-3/4"	<b>24565</b>	225	<b>24365</b>	75	<b>24265</b>	25	<b>24165</b>	8
1/4" x 1-3/4"			<b>24375</b>	75	<b>24275</b>	25	<b>24175</b>	8
1/4" x 2-1/4"			<b>24380</b>	75	<b>24280</b>	25	<b>24180</b>	8
1/4" x 2-3/4"	<b>24585</b>	150	<b>24385</b>	75	<b>24285</b>	25	<b>24185</b>	8
1/4" x 3-3/4"			<b>24395</b>	75	<b>24390</b>	25		
1/4" x 4"					<b>24397</b>	25		
<b>HEX HEAD</b>								
3/16" x 1-1/4"			<b>24300</b>	75	<b>24200</b>	25	<b>24100</b>	8
3/16" x 1-3/4"			<b>24305</b>	75	<b>24205</b>	25	<b>24105</b>	8
3/16" x 2-3/4"			<b>24310</b>	75	<b>24210</b>	25	<b>24110</b>	8
1/4" x 1-1/4"	<b>24515</b>	225	<b>24315</b>	75	<b>24215</b>	25	<b>24115</b>	8
1/4" x 1-3/4"	<b>24520</b>	225	<b>24320</b>	75	<b>24220</b>	25	<b>24120</b>	8
1/4" x 2-1/4"			<b>24325</b>	75	<b>24225</b>	25	<b>24125</b>	8
1/4" x 2-3/4"	<b>24530</b>	150	<b>24330</b>	75	<b>24230</b>	25	<b>24130</b>	8
1/4" x 3-1/4"			<b>24301</b>	75	<b>24335</b>	25	<b>24101</b>	8
1/4" x 3-3/4"			<b>24340</b>	75				
1/4" x 4"					<b>24345</b>	25		
<b>WHITE ULTRASHIELD TAPCON</b>								
3/16" x 3-1/4"			<b>24371</b>	75			<b>24171</b>	8
3/16" x 2-1/4"			<b>24372</b>	75			<b>24172</b>	8
3/16" x 2-3/4"			<b>24367</b>	75			<b>24167</b>	8
1/4" x 2-3/4"			<b>24388</b>	75	<b>24288</b>	25	<b>24188</b>	8
1/4" x 3-1/4"			<b>24391</b>	75				
1/4" x 3-3/4"			<b>24392</b>	75				
<b>410 STAINLESS STEEL TAPCON</b>								
3/16" x 1-3/4"							<b>26155</b>	8
3/16" x 2-3/4"							<b>26165</b>	8
1/4" x 1-3/4"							<b>26120</b>	8
1/4" x 2-3/4"							<b>26130</b>	8
<b>MAXI-SET TAPCON</b>								
1/4" x 2-1/4"			<b>24326</b>	50				
1/4" x 2-1/4" White			<b>24323</b>	50				
<b>TAPCON DRILL BITS</b>								
5/32" x 3-1/2"							<b>11256</b>	1
5/32" x 4-1/2"					<b>11249</b>	4	<b>11247</b>	1
5/32" x 5-1/2"							<b>11363</b>	1
3/16" x 3-1/2"							<b>11257</b>	1
3/16" x 4-1/2"					<b>11250</b>	4	<b>11248</b>	1
3/16" x 5-1/2"							<b>11362</b>	1
5/32" x 7" SDS							<b>11492</b>	1
3/16" x 7" SDS							<b>11491</b>	1
1/4" x 7" SDS							<b>11493</b>	1
3/8" x 8" SDS							<b>11494</b>	1
1/2" x 10" SDS							<b>11495</b>	1
<b>TAPCON PRO INSTALLATION KIT</b>								
Tapcon Pro Install Tool							<b>79012</b>	1



Ideal for projects that require heavy-duty holding power, Tapcon+ concrete screw anchors are the stronger, faster, and easier masonry anchoring solution. This heavy-duty screw anchor features a high-strength body that's built to resist both high wind and seismic tension and is ICC-ES approved for use in both cracked and un-cracked concrete.

Superior to wedge and sleeve anchors, Tapcon+ installs in less than half the time while delivering 20% more holding power and the flexibility to install closer to the edge of the concrete and closer to one another.

- **ICC-ES Approved** for use in uncracked & cracked concrete and seismic conditions (ESR-3699).
- **Heavy-Duty Holding Power** in all concrete conditions.
- **Flexibility** to install closer to the edge & closer together with confidence.
- A long-standing reputation for quality, strength and ease of installation from industry professionals.

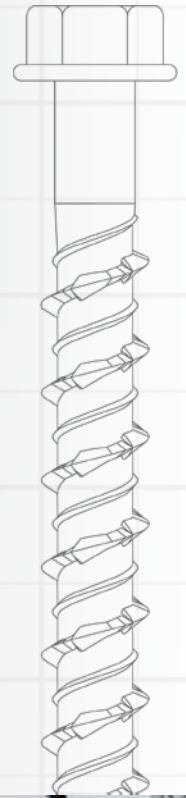

# TAPCON<sup>®</sup> CONCRETE SCREW ANCHORS

**Stronger. Faster. Easier.**

U.S. (Std.) Size (Dia. x Length)	Pro-Pak Part No.	Pro-Pak Qty.	Handy-Pak Part No.	Handy-Pak Pail Qty.	Part No.	Qty.
5/16" x 2-1/4"			<b>24292</b>	15	<b>24192</b>	4
5/16" x 3"			<b>24293</b>	15	<b>24193</b>	4
3/8" x 3"	<b>11413</b>	10			<b>50403</b>	2
3/8" x 4"	<b>11414</b>	10			<b>50404</b>	2
1/2" x 4"	<b>11420</b>	10			<b>50408</b>	2
1/2" x 6"	<b>11421</b>	10			<b>50426</b>	2



**ICC-ES ESR-3699**  
**2015 IBC**  
**Compliant**



Trubolt Wedge Anchors offer maximum strength and ultimate flexibility making them the PRO choice for heavy-duty anchoring. This wedge anchor features a high-strength body that is built to resist tension and shear loads, and it is code approved for use in uncracked concrete per ICC-ES ESR-2251.

Not only is Trubolt code recognized, but this wedge anchor offers a full line of diameter options and a variety of lengths. Trubolt wedge anchors are also available in both electrogalvanized and hot-dip galvanized finishes to perform in various applications. For additional application versatility, Trubolt wedge anchors are fully threaded to accommodate a greater range of fixture thicknesses. The wedge anchor's stainless steel clip provides extended corrosion resistance to ensure the long term integrity of connections.

- **ICC-ES Approved** for use in uncracked concrete ( ICC-ES-ESR-2251 ).
- **Heavy-Duty Holding Power** in concrete conditions.
- **Fully Threaded Anchor Design** for application versatility.
- **Stainless Steel Clip** provides additional corrosion protection.
- A long-standing reputation for quality, strength and ease of installation from industry professionals.



## TRUBOLT® WEDGE ANCHORS

### Maximum Strength for Heavy-Duty Concrete Anchoring

U.S. (Std.) Size (Dia. x Length)	Pro-Pak Part No.	Pro-Pak Qty.	Handy-Pak Part No.	Handy-Pak Pail Qty.	Poly-Bag Part No.	Poly-Bag Qty.
1/4" x 2-1/4"			<b>12377</b>	25	<b>50080</b>	1
3/8" x 2-1/4"	<b>12367</b>	50	<b>12015</b>	15	<b>50081</b>	1
3/8" x 3"	<b>03014</b>	50			<b>50082</b>	1
3/8" x 3-3/4"	<b>12370</b>	50	<b>12016</b>	15	<b>50083</b>	1
3/8" x 5"			<b>12022</b>	15	<b>50084</b>	1
1/2" x 2-3/4"					<b>50085</b>	1
1/2" x 3-3/4"	<b>12371</b>	25	<b>12017</b>	10	<b>50181</b>	1
1/2" x 4-1/4"	<b>12372</b>	25	<b>12020</b>	10	<b>50086</b>	1
1/2" x 5-1/2"	<b>12373</b>	25	<b>12019</b>	10	<b>50087</b>	1
1/2" x 7"					<b>50088</b>	1
5/8" x 5"	<b>12310</b>	10			<b>50089</b>	1
5/8" x 6"	<b>03041</b>	10				
5/8" x 7"	<b>03044</b>	10			<b>51030</b>	1
5/8" x 8-1/2"					<b>50305</b>	1
3/4" x 5-1/2"	<b>02992</b>	10			<b>51001</b>	1
3/4" x 10"						
1/2" x 5-1/2" HDG			<b>12021</b>	10	<b>50303</b>	1
1/2" x 7" HDG	<b>12029</b>	10			<b>50307</b>	1



As the company that invented concrete anchoring technology, Red Head holds a unique place in the history of construction and building. The Red Head brand has become synonymous with the anchoring product category it invented. That's why Red Head can help you get any job done right, from heavy-duty ceiling applications to light duty work in block and brick.

Our sleeve anchor line is our most versatile anchor with the ability to fasten in block, brick, masonry, and solid concrete.

For a lighter duty project, Poly-Set and Hammer-Set are great choices for block, brick and concrete and allow for quick and easy installation. For heavy-duty overhead applications, use our Drop-In anchors. Use the complete family of anchors and SDS bits to ensure precise hole depth and diameter when using our anchors.

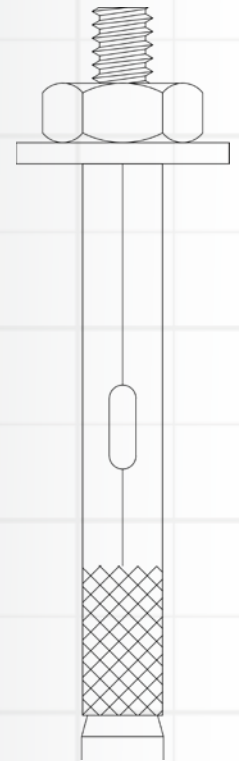

# RED HEAD® CONCRETE ANCHORS

## Versatile Anchoring Solutions for Construction & Building

U.S. (Std.) Size (Dia. x Length)	Pro-Pak Part No.	Pro-Pak Qty.	Handy-Pak Part No.	Handy-Pak Pail Qty.	Poly-Bag Part No.	Poly-Bag Qty.
<b>SLEEVE ANCHORS</b>						
1/4" x 2-1/4" Acorn Hd					50122	1
1/4" x 2-1/4" Threshold Hd					50123	1
1/4" x 3-1/8" Flat Hd					50121	1
5/16" x 1-1/2" Hex Hd					50112	1
5/16" x 2-1/2" Hex Hd					50113	1
3/8" x 1-7/8" Hex Hd					50114	1
3/8" x 3" Hex Hd	11281	50	11013	15	50115	1
1/2" x 2-1/4" Hex Hd					50116	1
1/2" x 3" Hex Hd	11283	25	11014	10	50117	1
1/2" x 4" Hex Hd	11285	25	11018	10	50118	1
5/8" x 4-1/4" Hex Hd					50119	1
5/8" x 6" Hex Hd					50120	1
<b>POLY-SET ANCHORS</b>						
1-1/4"			35220	50		
1-7/16"			35225	50		
<b>HAMMER-SET ANCHORS</b>						
1/4" x 1"	35300	75	35200	25		
1/4" x 1-1/2"	35303	50	35203	15		
1/4" x 2"	35305	50	35205	15		
<b>DROP-IN ANCHORS</b>						
3/8" Anchor					50125	1
1/2" Anchor					50126	1
3/8" Setting Tool					07499	1
1/2" Setting Tool					07501	1





For jobs requiring versatility, high performance, and efficiency, Red Head's A7+ Concrete Adhesive Anchor is the one anchoring solution that does it all. A7+ takes only 45 minutes to fully cure and can be used in challenging conditions like cold temperatures and water-filled holes. A7+ is also ICC-ES approved for cracked concrete and seismic building code requirements.

A7+ can also be used in any standard medium-duty caulk gun, eliminating the inconvenience of needing a special dispensing tool. Combine the simplicity of dispensing with the quick-curing product, and installation is fast, easy, and doesn't take time away from the rest of the project.

The A7+ concrete adhesive anchoring solution is a high-performing anchor that rivals other products on the market in both price and features. This high performance and efficiency allows for less time on the job and more productivity.

Providing code approved performance and a fast 45 minute cure time, Red Head A7+ is the concrete anchoring adhesive that delivers.



## RED HEAD® A7+ ADHESIVE ANCHORS

### High Strength Adhesive Anchoring Solution for Harsh Conditions



- **ICC-ES Approved** for use in cracked concrete and seismic conditions (ICC-ES ESR-3903).
- **Quick 45 Minute Cure Time** for fast installation.
- **Easy Dispensing** with a standard caulk gun, eliminating the need for any special tools.
- A successful cure in cold temperatures, as low as 14° F.
- Increased productivity with a successful cure in saturated concrete and water-filled holes.
- A long-standing reputation for quality, strength and ease of installation from industry professionals.



ICC-ES ESR-3903  
2015 IBC  
Compliant

U.S. (Std.) Size	Part No.	Qty.
9.5 oz. Cartridge	07111	1

Ramset is a leading line of powder actuated tools and fasteners for residential and commercial remodeling. As the developer of the very first powder actuated tool in 1948, Ramset has a history of reliability, innovation, and market-leading performance. Ramset has supplied more than a million tools to professional contractors specialty tradesmen and continues to deliver products that drive jobsite speed. Utilizing the whole line of Ramset tools, powder loads, and fasteners increases jobsite productivity and leads to a job done right.

From tools that display the market leading innovation, like Cobra+ and MasterShot, to the full range of drive pins and powder loads for your applications, you can be sure to find what you need with the Ramset family of products.



## RAMSET® TOOLS AND FASTENERS

Powder Actuated Tools for Residential & Commercial Remodeling.

- For use in solid concrete
- Drives jobsite speed through quick and efficient fastening
- Market leading tool innovations help you get the job done right
- The Powder Actuated Tool choice for PROs



Item / Tools	Part No.	Qty.
<b>HammerShot</b> .22 Caliber Single-Shot Powder Actuated Tool	<b>00022</b>	1
<b>TriggerShot</b> .22 Caliber Single-Shot Powder Actuated Tool	<b>40066</b>	1
<b>MasterShot</b> .22 Caliber Single-Shot Powder Actuated Tool	<b>40088</b>	1
<b>Cobra+</b> .27 Caliber Semi-Automatic Powder Actuated Tool	<b>16942</b>	1

U.S. (Std.)Size	Large Box Part No.	Large Box Quantity	Small Clam Part No.	Small Clam Quantity
<b>DRIVE PINS</b>				
.300 x 1/2"	<b>06171</b>	100		
.300 x 3/4"	<b>00747</b>	100		
.300 x 1"	<b>00759</b>	100		
.300 x 1-1/2"	<b>00774</b>	100		
.300 x 2"	<b>00780</b>	100		
.300 x 2-1/2"	<b>00786</b>	100	<b>00787</b>	25
.300 x 3"	<b>00794</b>	100		
.300 x 2-1/2" w/Ramguard	<b>09167</b>	100		

<b>WASHERED DRIVE PINS</b>				
.300 x 1" Washered Drive Pin	<b>00797</b>	100		
.300 x 1-1/2" Washered Drive Pin	<b>00803</b>	100	<b>00804</b>	25
.300 x 1-1/4" Washered Drive Pin	<b>00800</b>	100		
.300 x 2" Washered Drive Pin	<b>00806</b>	100		
.300 x 2-1/2" Washered Drive Pin	<b>00809</b>	100	<b>00810</b>	25
.300 x 2-1/2" Washered Drive Pin w/ Ramguard	<b>09173</b>	100		
.300 x 3" Washered Drive Pin	<b>07886</b>	100	<b>07887</b>	25
.300 x 3" Washered Drive Pin w/Ramguard	<b>09176</b>	100		

Caliber	Color	Type	Strip Load Part No.	Qty.	Single Shot Box Pt. #	Single Shot Box Qty.	Single Shot Blister Pt.#	Single Shot Blister Qty.
---------	-------	------	---------------------	------	-----------------------	----------------------	--------------------------	--------------------------

<b>POWDER LOADS</b>								
.22	Brown	Powder			<b>00594</b>	100		
.22	Green	Powder			<b>00601</b>	100		
.22	Yellow	Powder			<b>00607</b>	100	<b>50077</b>	25
.27	Green	Strip	<b>00652</b>	100				
.27	Yellow	Strip	<b>00667</b>	100				
.27	Red	Strip	<b>00682</b>	100				



Teks® fasteners are the leading choice of self-tapping screws for use in interior/exterior applications; including metal-to-metal, wood-to-metal, and roofing applications. Professionals are able to drill faster with less force even in heavy gauge metal. The self-tapping threads are designed to tap holes while providing superior holding power ensuring strong connections between materials.

Teks® fasteners are offered in sharp and drill points that easily penetrate light to heavy gauge metal and wood. Professionals no longer have to struggle when engaging their work surface.

Teks® fasteners are offered in a wide variety of head styles to meet professionals installation needs. No tool slippage or cam-outs even with old sockets and worn bits. Professionals can drill, tap, and fasten – all in one motion.



**Teks®**  
THE ORIGINAL



## TEKS® METAL FASTENERS

Pro Known. Pro Used. Pro Trusted.

- **Drive surface and recess:** Reduces cam-outs to prevent slipping during installation.
- **Drill Points:** Self-drills through light to heavy gauge metal with ease.
- **Sharp Points:** Self-pierces into light gauge metal to start drilling faster.
- **Self-Tapping Threads:** Taps their own threads to provide less effort when fastening into metal.
- **Corrosion Resistant Finish:** Protects the job's appearance with long lasting coating.
- **Neoprene Washer:** Roofing screws feature a neoprene washer that provides a waterproof seal.
- **Reamer Wings:** Winged screws self-drill into wood and engage metal to provide a secure hold.
- **Lath head:** Lath Screws feature a low-profile head for a semi-flush finish for virtually any application.

U.S. (Std.) Size (Dia. x Length)	Pro-Pak Part No.	Pro-Pak Pail Qty.	Handy-Pak Part No.	Handy-Pak Ctn. Size/Qty.
<b>TEKS® SELF-TAPPING SCREWS</b>				
<b>HEX WASHER HEAD / DRILL POINT ( METAL TO METAL )</b>				
8 x 1/2"	21322	450	21308	S/280
8 x 3/4"			21312	S/180
8 x 1"			21316	S/170
10 x 5/8"			21396	S/170
10 x 3/4"			21320	S/150
10 x 1"			21328	M/140
10 x 1-1/2"			21332	M/90
12 x 3/4"			21336	M/120
12 x 1"			21340	M/100
12 x 1-1/2"			21344	M/80
12 x 2"	21348	M/60		
12/14 x 2"	21820	M/60		
14 x 3/4"	21349	S/100		
14 x 1"	21351	S/60		
14 x 1-1/2"	21352	M/50		
14 x 2-1/2"	21358	120	21356	M/30
<b>HEX WASHER HEAD / SHARP POINT ( METAL TO METAL )</b>				
6 x 1/2"			21301	S/320
8 x 1-1/2"			21318	M/85
10 x 3/4"			21327	M/150
<b>PAN HEAD / DRILL POINT ( METAL TO METAL )</b>				
8 x 1/2"			21360	S/300
8 x 3/4"			21364	S/240
10 x 3/4"			21372	S/170
<b>PAN HEAD / SHARP POINT ( METAL TO METAL )</b>				
6 x 1/2"			21359	S/300
<b>PANCAKE HEAD / DRILL POINT ( METAL TO METAL )</b>				
10 x 5/8"			21376	S/190
<b>PHILLIPS FLAT HEAD / DRILL POINT W/REAMER WINGS ( WOOD TO METAL )</b>				
1/4-20 x 3"	21381	300	21378	M/40
10 x 1-7/16"			21380	S/100
12 x 2-3/4"			21386	200

U.S. (Std.) Size (Dia. x Length)	Pro-Pak Part No.	Pro-Pak Pail Qty.	Handy-Pak Part No.	Handy-Pak Ctn. Size/Qty.
<b>TEKS® ROOFING SCREWS</b>				
<b>HEX WASHER HEAD / SHARP POINT ( METAL TO WOOD )</b>				
9 x 1"	21401	360	21400	M/120
9 x 1-1/2"	21406	400	21404	M/100
9 x 2-1/2"			21407	M/60
<b>HEX WASHER HEAD / DRILL POINT ( METAL TO METAL )</b>				
12 x 3/4"			21408	M/90
12 x 1"	21418	400	21412	M/80
12 x 1-1/2"	21422	300		
12 x 2"	21427	150	21416	M/50
<b>TEKS® LATH SCREWS</b>				
<b>MODIFIED TRUSS HEAD / SHARP POINT ( METAL TO METAL )</b>				
8 x 1/2"	21506	600	21500	S/260
8 x 3/4"			21504	S/200
8 x 1"	21510	510	21508	S/170
8 x 1-1/4"			21512	M/140
8 x 1-5/8"			21516	M/120
8 x 2"			21518	M/100
8 x 2-1/2"			21519	M/80
<b>MODIFIED TRUSS HEAD / DRILL POINT ( METAL TO METAL )</b>				
8 x 1/2"	21525	600	21520	S/260
8 x 3/4"			21524	S/200
8 x 1"	21530	510	21528	S/170
8 x 1-1/4"			21532	M/140
8 x 1-5/8"			21536	M/120
8 x 2"			21538	M/100
8 x 2-1/2"			21540	M/80

Pro-Paks and Handy-Paks must be ordered in eaches but in Master Carton Quantities.



Hex Washer Head



Flat Head



Pan Head



Modified Truss Head

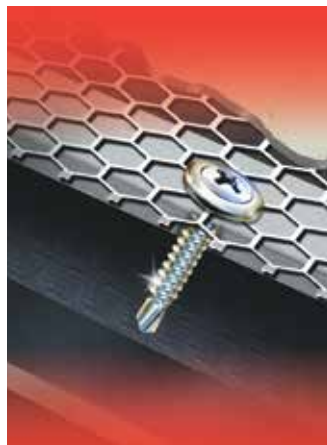
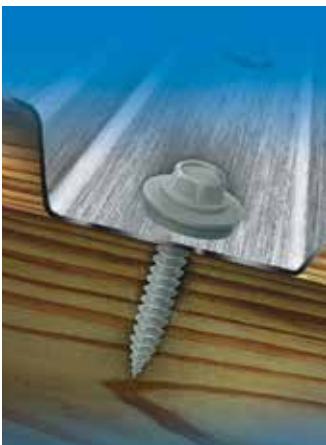

Backer-On® cement screws are designed for attaching Hardie-Backer® cement board and Rock-On® cement board screws are designed for attaching Durock® cement board to wood or light gauge steel studs. The patented serrated head design countersinks for a flush finish even at angle, providing a smooth surface for tile installation. The T-25 Star Drive recess provides Stikfit™ for one-handed installation. Climacoat corrosion resistant finish prevents rust from bleeding into grout. Making it perfect for use in high moisture areas such as bathrooms and kitchens.

Backer-On® and Rock-On® cement board screws comply with ANSI standards for cement board installation as specified by cement board manufacturers. Cement board manufacturers require ANSI compliance in order to remain eligible for warranty.

- **Serrated head:** Designed to drive flush even at an angle.
- **Star drive with T-25 bit:** provides Stikfit™ for easy one-handed installation and eliminates cam-outs.
- **Hi-Lo / Single Threads:** starts quickly and drives smooth in cement boards.
- **Sharp points:** Offers immediate pick-up and eliminates the need to pre-drill.
- **Climacoat finish:** Corrosion resistant for preventing rust from bleeding into tile.



# BACKER-ON® ROCK-ON® CEMENT BOARD SCREWS

BACKER-ON® / ROCK-ON® Patented Serrated Head for Flush Seating

U.S. (Std.) Size (Dia.x Length)	Pro-Pak Part No.	Pro-Pak Pail Qty.	Handy-Pak Part No.	Handy-Pak Ctn. Size/Qty.
<b>BACKER-ON® SCREWS</b>				
#9 x 1-1/4"	<b>23406</b>	750	<b>23401</b>	M/185
#9 x 1-5/8"	<b>23416</b>	575	<b>23411</b>	M/140
#9 x 2-1/4"			<b>23421</b>	M/100
<b>ROCK-ON® SCREWS</b>				
#9 x 1-1/4"	<b>23306</b>	750	<b>23301</b>	M/185
#9 x 1-5/8"	<b>23316</b>	575	<b>23311</b>	M/140
#9 x 2-1/4"			<b>23321</b>	M/100

2" T25 Star Drive bit included in Backer-On and Rock-On handy-paks and Pro-paks.



<b>BACKER-ON® / ROCK-ON® StikFit Bit</b>		
SIZE POINT	PART NO.	CARDER QUANTITY / PER PACK
#T-25 2"	<b>24000</b>	( 2 ) StikFit Bits

The T-25 StikFit Bits modified tip eliminates wobble and offers one-handed installation only for Backer-On/Rock-On cement board screws. The bits are made with S2 modified steel for long lasting bit life.

**Pro Tip:** Standard roofing nails, dry wall screws, and other alternatives to cement board screws are typically not specified by cement board manufacturers and not ANSI compliant.

## Star Drive Bits, Crown / Bit



Bit Size	Bit Color	Fits	Bulk Part No.	Bulk Box Qty.	Carded Part No.	Carded Qty/per pack
T-10 2" T-10 3"	yellow yellow	Trim™ Head #8	86419	25	187419 87421	2 2
T-15 2" T-15 3"	red red	R4™ Screw #6 & 8 Trim™ Head #9 Cabinet™ Screw	86427	25	187427 87429	2 2
T-20 2"	purple		86435	25	187435	2
T-25 2" T-25 3"	green green	R4™ #9,10 & 12 RSS™ #10 & 1/4" MSS™ #9	86443	25	187443 87445	2 2
T-30 2" T-30 3"	black black	RSS™ Structural Screw 5/16" Caliburn™ & Caliburn PH™	86451	25	187451 87453	2 2
T-40 2"	blue	Caliburn XL™ Screws RSS™ Structural Screw 3/8"	86459	25	187459	2
CROWN / BIT						
		TOP STAR™			86465	1

# High Impact Merchandisers Designed to Drive Sales

Displays are free with qualifying order.

## Rolling Rack:

GRK5432 Formerly #89001-GRK  
(includes header)

Ideal for secondary placement. Can be moved around retail space. Holds Pro-Paks, Handy-Paks, Blister-Paks and/or open stock in bins.



## Universal Display:

GRK# 99900  
(includes header)

Ideal for end-cap with large selection of GRK product.





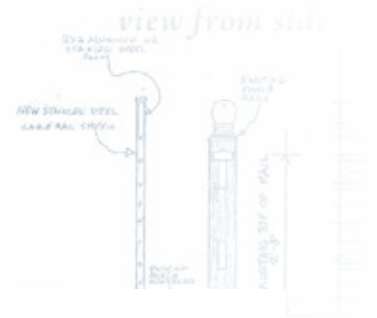

# FASTENER TECHNICAL DATA

## RSS™

TABLE 1—RSS™ FASTENER SPECIFICATIONS

FASTENER DESIGNATION N	LENGTH <sup>1</sup> (inches)	THREAD LENGTH <sup>2</sup> (inches)	MINOR THREAD DIAMETER (inch)	SHANK DIAMETER (inch)	OUTSIDE THREAD DIAMETER (inch)	NOMINAL BENDING YIELD STRENGTH <sup>3</sup> F <sub>yb</sub> (psi)	ALLOWABLE STEEL STRENGTH		
							TENSILE (lbf)	SHEAR (lbf)	
RSS	1/4 x 2 1/2"	2 3/8	1 1/2	0.152	0.169	0.236	170,400	1112	754
	1/4 x 2 3/4"	2 3/4	1 3/4						
	1/4 x 3 1/8"	3 1/8	2						
	1/4 x 3 1/2"	3 1/2	2 3/8						
	5/16 x 2 1/2"	2 3/8	1 1/2	0.167	0.195	0.276	190,900	1415	982
	5/16 x 2 3/4"	2 3/4	1 3/4						
	5/16 x 3 1/8"	3 1/8	2 1/8						
	5/16 x 3 1/2"	3 1/2	2 1/2						
	5/16 x 4"	3 7/8	2 3/4						
	5/16 x 5 1/8"	5	3 1/2						
	5/16 x 6"	5 7/8	3 7/8						
	3/8 x 3 1/8"	3 1/8	2 1/8						
3/8 x 4"	3 7/8	2 3/4							
3/8 x 5 1/8"	5 1/8	3 1/2							
3/8 x 6"	5 7/8	4							
3/8 x 7 1/4"	7	4 1/2							
3/8 x 8"	7 7/8	4 3/8							
3/8 x 10"	9 3/4	5							
3/8 x 12"	11 7/8	5 7/8							
3/8 x 14 1/8"	14 1/8	5 7/8	0.152	0.171	0.240	172,600	1051	666	
LPS	1/4 x 8"	7 7/8							2 7/8
LTF	3/8 x 8"	7 7/8	3 7/8	0.191	0.219	0.311	167,600	1714	1094
	3/8 x 10"	9 7/8	3 7/8						
	3/8 x 12"	11 3/4	3 7/8						
RSS PHEinox	1/4 x 2 1/2"	2 3/8	1 1/2	0.152	0.169	0.236	111,400	628	546
	1/4 x 3 1/8"	3 1/8	2						
	5/16 x 2 1/2"	2 3/8	1 5/8	.167	0.195	0.276	118,300	806	668
	5/16 x 3 1/8"	3 1/8	2 1/8						
	5/16 x 4"	3 7/8	2 1/2						
	5/16 x 5 1/8"	5 1/8	3 3/8						
5/16 x 6"	5 7/8	3 7/8	0.152	0.171	0.240	226,300	1104	769	
JTS	1/4 x 3 7/8"	3 7/8							1 3/8
1/4 x 5"	5	1 5/8							
	1/4 x 6 3/4"	6 3/4	1 1/2						

For SI: 1 inch = 25.4 mm; 1 psi = 6.9 kPa; 1 lbf = 4.4 N.

<sup>1</sup>The length of fasteners is measured from the underside of the head to bottom of the tip. See Figure 1.

<sup>2</sup>Length of thread includes tip. See Figure 1.

<sup>3</sup>Bending yield strength determined in accordance with ASTM F1575 using the minor thread diameter.

<sup>4</sup>See Figure 1 for additional dimensional information.

# RSS™

TABLE 2—RSS™ REFERENCE WITHDRAWAL (W) AND PULL-THROUGH (P) DESIGN VALUES<sup>1</sup>

FASTENER DESIGNATION	THREAD LENGTH (inches)	W (lbf/in.) <sup>2</sup>		P (lbf) <sup>3</sup>		WET SERVICE FACTOR, C <sub>M</sub>	
		For Specific Gravities of:		For Specific Gravities of:			
		0.42 ≤ G < 0.55	0.55 ≤ G < 0.67	0.42 ≤ G < 0.55	0.55 ≤ G < 0.67		
RSS	1/4 x 2 1/2"	151	186	165	275	0.70	
	1/4 x 2 3/4"						
	1/4 x 3 1/8"						
	1/4 x 3 1/2"						
	5/16 x 2 1/2"	165	227	207	418		
	5/16 x 2 3/4"						
	5/16 x 3 1/8"						
	5/16 x 3 1/2"						
	5/16 x 4"	180	259	196	351		
	5/16 x 5 1/8"						
	5/16 x 6"						
	3/8 x 3 1/8"						
	3/8 x 4"						
	3/8 x 5 1/8"						
	3/8 x 6"						
3/8 x 7 1/4"							
3/8 x 8"							
3/8 x 10"							
3/8 x 12"							
3/8 x 14 1/8"							
3/8 x 16"							
LPS	1/4 x 8"	2 7/8	128	201	136	395	0.52
LTF	3/8 x 8"	3 7/8	163	216	202	373	0.70
	3/8 x 10"	3 7/8					
	3/8 x 12"	3 7/8					
PHEinox	1/4 x 2 1/2"	1 1/2	134	187	162	306	0.70
	1/4 x 3 1/8"	2					
	5/16 x 2 1/2"	1 5/8	136	202	199	254	
	5/16 x 3 1/8"	2 1/8					
	5/16 x 4"	2 1/2					
	5/16 x 5 1/8"	3 3/8					
5/16 x 6"	3 7/8						
JTS	1/4 x 3 3/8"	1 3/8	152	191	154	372	0.68
	1/4 x 5"	1 5/8					
	1/4 x 6 3/4"	1 1/2					

For SI: 1 inch = 25.4 mm; 1 lbf = 4.4 N.

<sup>1</sup>Values must be multiplied by all applicable adjustment factors, in accordance with the NDS. When the fasteners are used in wet service conditions, the wet service factors shown in the table are applicable.

<sup>2</sup>Tabulated reference withdrawal design values are in pounds per inch of thread penetration into the side grain of the main member, and must be multiplied by the thread length embedded in the member in order to get the total withdrawal design value in pounds. Length of CEE threads must not be included in the withdrawal value determination.

<sup>3</sup>Tabulated pull-through design values are based on a minimum side member thickness of 3/4 inch.

These figures are only offered as a guide and are not reduce by any safety factor.  
For safety factor requirements in your area, contact your local building official, architect or engineer.

**TABLE 3—RSS™ REFERENCE LATERAL DESIGN VALUES (Z) FOR SINGLE SHEAR (TWO-MEMBER) CONNECTIONS<sup>1</sup>**  
 [For Sawn Lumber with Both Members of Identical Specific Gravity]

FASTENER DESIGNATION	SIDE MEMBER THICKNESS, t (inches)	FASTENER PENETRATION INTO MAIN MEMBER, p (inches)	REFERENCE LATERAL DESIGN VALUE, Z (lbf) FOR SPECIFIC GRAVITIES OF:				WET SERVICE FACTOR, C <sub>w</sub>	
			0.42 ≤ G < 0.55		0.55 ≤ G < 0.67			
			Parallel to Grain, Z <sub>∥</sub>	Perpendicular to Grain, Z <sub>⊥</sub>	Parallel to Grain, Z <sub>∥</sub>	Perpendicular to Grain, Z <sub>⊥</sub>		
RSS	1/4 x 2 1/2"	3/4	153	137	175	175	0.70	
	1/4 x 2 3/4"	3/4						2
	1/4 x 3 1/8"	3/4						2 3/8
	1/4 x 3 1/2"	3/4	2 3/4	168	133	214		178
	5/16 x 2 1/2"	3/4	1 5/8					
	5/16 x 2 3/4"	3/4	2					
	5/16 x 3 1/8"	3/4	2 3/8					
	5/16 x 3 1/2"	3/4	2 3/4	239	236	333		257
	5/16 x 4"	1 1/2	2 3/8					
	5/16 x 5 1/8"	1 1/2	3 1/2	265	299	472		289
	5/16 x 6"	2	3 7/8					
	3/8 x 3 1/8"	3/4	2 3/8	188	156	251		220
	3/8 x 4"	1 1/2	2 3/8					
	3/8 x 5 1/8"	1 1/2	3 5/8	224	205	274		264
	3/8 x 6"	2	3 7/8					
	3/8 x 7 1/4"	2 3/4	4 1/4	423	291	593		304
	3/8 x 8"	3 1/2	4 3/8					
	3/8 x 10"	3 1/2	6 1/4					
3/8 x 12"	3 1/2	8 3/8						
3/8 x 14 1/8"	3 1/2	10 5/8						
3/8 x 16"	3 1/2	12 1/8						
LPS	1/4 x 8"	5	249	257	358	219	0.62	
LTF	3/8 x 8"	4	433	315	556	402	0.70	
	3/8 x 10"	6						
	3/8 x 12"	8						
PHEInox	1/4 x 2 1/2"	3/4	162	134	215	185	0.70	
	1/4 x 3 1/8"	3/4						2 3/8
	5/16 x 2 1/2"	3/4	151	149	181	175		
	5/16 x 3 1/8"	3/4						2 3/8
	5/16 x 4"	1 1/2	249	229	337	272		
	5/16 x 5 1/8"	1 1/2						3 5/8
5/16 x 6"	2	302	340	449	358			
JTS	1/4 x 3 3/8"	1 3/4	157	168	217	217	0.70	
	1/4 x 5"	1 3/4	168	221	241	237		
	1/4 x 6 3/4"	1 3/4						5

For S<sub>E</sub>: 1 inch = 25.4 mm ; 1 lbf = 4.4 N.

<sup>1</sup>Values must be multiplied by all applicable adjustment factors, in accordance with the NDS. When the fasteners are used in wet service conditions, the wet service factors shown in the table are applicable.

These figures are only offered as a guide and are not reduce by any safety factor.  
 For safety factor requirements in your area, contact your local building official, architect or engineer.

# FASTENER TECHNICAL DATA

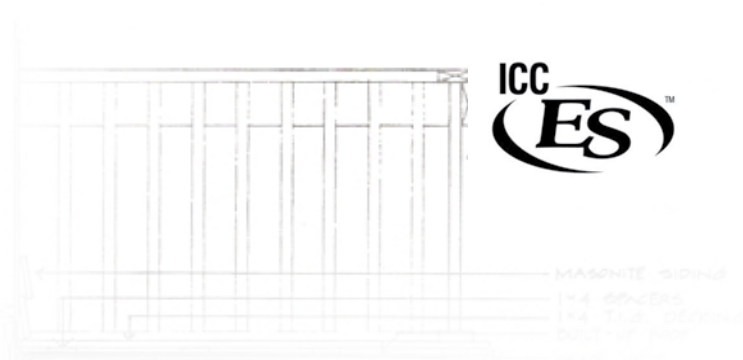

## RSS™

TABLE 4 - CONNECTION GEOMETRY

CONNECTION GEOMETRY / CRITERIA	DIAMETERS <sup>1</sup>	RSS, LPS, JTS & PHEINOX 1/4" NOMINAL DIAMETER (inches)	RSS & PHEINOX 5/16" NOMINAL DIAMETER (inches)	RSS & LTF 3/8" NOMINAL DIAMETER (inches)
Minimum Edge Distance				
Loading Parallel to Grain	8	1 1/2	1 5/8	1 7/8
Loading Perpendicular to grain, Loaded Edge	8	1 1/2	1 5/8	1 7/8
Loading Perpendicular to grain, Unloaded Edge	8	1 1/2	1 5/8	1 7/8
Minimum End Distance				
Tension Load Parallel to Grain	15	2 5/8	3	3 3/8
Compression Load Parallel to Grain	10	1 3/4	2	2 1/4
Load Perpendicular to Grain	10	1 3/4	2	2 1/4
Spacing (Pitch) Between Fasteners in a Row				
Parallel to Grain	15	2 5/8	3	3 3/8
Perpendicular to Grain	10	1 3/4	2	2 1/4
Spacing (Gage) Between Rows of Fasteners				
In-Line	5	7/8	1	1 1/8
Staggered	2.5	1/2	1/2	5/8
Minimum Penetration into Main Member For Single Shear Connections	6	1 1/8	1 1/4	1 3/8

For SI: 1 inch = 25.4 mm

<sup>1</sup> Diameter is the shank diameter as specified in Table 1.

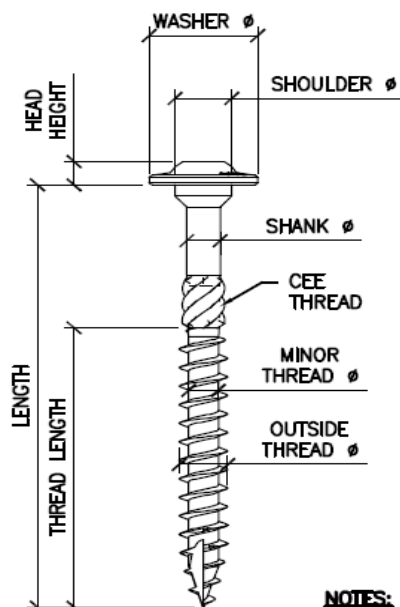

SCREW TYPE	HEAD STAMP	WASHER Ø ± 0.020	HEAD HEIGHT ± 0.010	SHOULDER Ø ± 0.010	CEE THREAD <sup>2</sup>
RSS 1/4 (6.0mm)		0.533	0.110	0.244	LENGTH ≥ 3/8"
RSS 5/16 (7.0mm)		0.620	0.157	0.301	LENGTH ≥ 3/8"
RSS 3/8 (8.0mm)		0.689	0.181	0.364	LENGTH ≥ 3/8"
LTF 3/8 (8.0mm)		0.688	0.181	0.364	LENGTH ≥ 3/8"
LPS 1/4 (6.0mm)		0.535	0.090	0.244	NO
JTS 1/4 (6.3mm)		0.534	0.090	0.244	LENGTH ≥ 5"

**NOTES:**

- SEE TABLE 1 FOR OVERALL LENGTH, THREAD LENGTH, SHANK DIAMETER, OUTSIDE THREAD DIAMETER AND MINOR THREAD DIAMETER.
- CEE THREAD ON SCREWS WITH LENGTHS GREATER THAN OR EQUAL TO THOSE INDICATED. NOT USED FOR CALCULATIONS.

**FIGURE 1 – FASTENER DIMENSIONS**

# FASTENER TECHNICAL DATA

## R4™, Trim™



TABLE 1A—CARBON STEEL FASTENER SPECIFICATIONS

FASTENER DESIGNATION	OVERALL LENGTH <sup>1</sup> (inches)	THREAD LENGTH <sup>2</sup> (inches)	HEAD DIAMETER (inch)	HEAD RECESS	ROOT DIAMETER (inch)	SHANK DIAMETER (inch)	OUTSIDE THREAD DIAMETER (inch)	BENDING YIELD STRENGTH <sup>3</sup> F <sub>y</sub> (psi)	ALLOWABLE STEEL STRENGTH		
									Tensile (lbf)	Shear (lbf)	
R4	9x2"	2	1 1/4	0.329	Star drive T-25	0.112	0.128	0.173	158,800	627	428
	9x2 1/2"	2 1/2	1 1/2								
	9x2 3/4"	2 3/4	1 5/8								
	9x3 1/4"	3 1/4	1 7/8 (2 1/4)	0.368	Star drive T-25	0.124	0.142	0.193	143,590	846	542
	10x2 1/2"	2 1/2	1 1/2								
	10x2 3/4"	2 3/4	1 5/8								
	10x3 1/4"	3 1/4	1 7/8 (2 1/4)								
	10x3 1/2"	3 1/2	2 (2 1/2)								
	10x4"	3 3/4	2 1/2								
	10x4 1/4"	4 1/4	3	0.439	Star drive T-25	0.148	0.171	0.234	134,280	1134	655
	12x4 1/4"	4 1/4	3								
	12x5 1/4"	5 1/4	3								
	12x6 1/4"	6 1/4	3								
12x7 1/4"	7 1/4	3									
12x8"	7 3/4	3									
12x10"	9 3/4	3									
12x12"	11 3/4	3									
FIN/TRIM	8x2 1/2"	2 1/2	1 1/2	0.197	Star drive T-10	0.100	0.111	0.156	148,410	499	360
	8x2 3/4"	2 3/4	1 5/8								
	8x3 1/4"	3 1/4	2 1/2	0.230	Star drive T-15	0.112	0.128	0.175	147,280	576	425
	9x2 1/2"	2 1/2	1 1/2								
	9x2 3/4"	2 3/4	1 5/8								
9x3 1/4"	3 1/4	2 1/2									

TABLE 1B—PHEINOX™ FASTENER SPECIFICATIONS

FASTENER DESIGNATION	OVERALL LENGTH <sup>1</sup> (inches)	THREAD LENGTH <sup>2</sup> (inches)	HEAD DIAMETER (inch)	DRIVER SIZE	ROOT DIAMETER (inch)	SHANK DIAMETER (inch)	OUTSIDE THREAD DIAMETER (inch)	BENDING YIELD STRENGTH <sup>3</sup> F <sub>y</sub> (psi)	ALLOWABLE STEEL STRENGTH		
									Tensile (lbf)	Shear (lbf)	
R4	9x2"	2	1 1/4	Star drive T-25	0.112	0.128	0.173	113,340	467	334	
	10x2 1/2"	2 1/2	1 1/2								
	10x2 3/4"	2 3/4	1 5/8	0.368	Star drive T-25	0.124	0.142	0.193	170,220	490	424
	10x3 1/4"	3 1/4	1 7/8 (2 1/4)								
	10x4"	3 3/4	2 1/2								
FIN/TRIM, RT COMPOSITE	8x2 1/2"	2 1/2	1 1/2	Star drive T-10	0.100	0.111	0.156	117,540	350	267	
	8x2 3/4"	2 3/4	1 5/8								
	8x3 1/4"	3 1/4	2 1/2								
	9x2 1/2"	2 1/2	1 1/2	Star drive T-15	0.112	0.128	0.175	66,340	394	319	
	9x2 3/4"	2 3/4	1 5/8								
	9x3 1/4"	3 1/4	2 1/2								

For SI: 1 inch = 25.4 mm; 1 psi = 6.9 kPa.

<sup>1</sup>Overall length of fastener is measured from the top of the head to bottom of the tip. See Figure 1.

<sup>2</sup>Length of thread includes tip. Where two thread lengths are shown, the first refers to thread length of screws marked with "GRK" on the fastener head, and the one in parentheses refers to screws which do not have this marking on the head. See detailed illustrations in Figure 1.

<sup>3</sup>Bending yield strength determined in accordance with ASTM F1575 using the root diameter.

# FASTENER TECHNICAL DATA

## R4™, Trim™

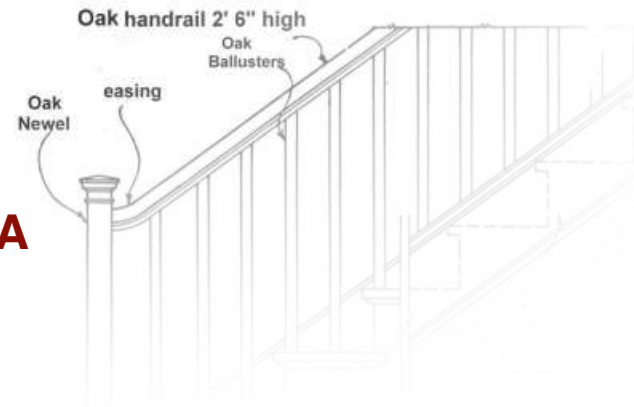

TABLE 2A— REFERENCE WITHDRAWAL DESIGN VALUES (W) FOR CLIMATEK™ COATED FASTENERS<sup>1,2</sup>

FASTENER DESIGNATION	THREAD LENGTH <sup>3</sup> (inches)	W (lbf/in.) FOR SPECIFIC GRAVITIES (SG) OF:			
		SG ≥ 0.67 <sup>4</sup>	0.58 ≥ SG ≥ 0.55	0.55 > SG ≥ 0.49	0.49 > SG ≥ 0.42
R4	9x2"	179	221	172	124
	9x2 1/2"				
	9x3"				
	9x3 1/2"				
	10x2 1/2"	249	228	155	133
	10x2 3/4"				
	10x3"				
	10x3 1/2"				
	10x4"	255	217	209	141
	10x4 1/2"				
	12x4 1/2"				
	12x5 1/2"				
12x6 1/2"					
12x7 1/2"					
12x8"					
12x10"					
12x12"	175	n/a	n/a	n/a	
8x2 1/2"					
8x3 1/2"					
8x4"					
FIN/RTM	9x2 1/2"	221	n/a	n/a	n/a
	9x2 3/4"				
	9x3 1/2"				

For SI: 1 inch = 25.4 mm; 1 lbf/in = 178 N/m.

<sup>1</sup>Tabulated reference withdrawal design values (W) are in pounds per inch of thread penetration into side grain of main member.  
<sup>2</sup>Values must be multiplied by applicable adjustment factors, in accordance with the NDS, and must be multiplied by the length of thread penetration in the main member, including tip.  
<sup>3</sup>Where two thread lengths are shown, the first refers to thread length of screws marked with "GRK" on the fastener head, and the second refers to screws which do not have this marking on the head.  
<sup>4</sup>Pilot holes equal to 70% of the root diameter of the screw are required, and the tabulated values are applicable to connections subject to tension load only, due to differing pilot hole requirements for lateral connections.

TABLE 3A— REFERENCE PULL-THROUGH DESIGN VALUES (P) FOR CLIMATEK™ COATED FASTENERS<sup>1</sup>

FASTENER DESIGNATION	MINIMUM SIDE MEMBER THICKNESS (inch)	P (lbf) FOR SPECIFIC GRAVITIES (SG) OF:			
		SG ≥ 0.67 <sup>2</sup>	0.58 ≥ SG ≥ 0.55	0.55 > SG ≥ 0.49	0.49 > SG ≥ 0.42
R4	9x2"	162	119	107	83
	9x2 1/2"				
	9x3"				
	9x3 1/2"				
	10x2 1/2"	275	140	126	103
	10x2 3/4"				
	10x3"				
	10x3 1/2"				
	10x4"	407	176	171	126
	10x4 1/2"				
	12x4 1/2"				
	12x5 1/2"				
12x6 1/2"					
12x7 1/2"					
12x8"					
12x10"					
12x12"	61	n/a	n/a	n/a	
8x2 1/2"					
8x3 1/2"					
8x4"					
FIN/RTM	9x2 1/2"	94	n/a	n/a	n/a
	9x2 3/4"				
	9x3 1/2"				

For SI: 1 inch = 25.4 mm; 1 lbf = 4.45 N.

<sup>1</sup>Values must be multiplied by applicable adjustment factors, in accordance with the NDS.  
<sup>2</sup>Pilot holes equal to 90% of the root diameter of the screw are required, and the tabulated values are applicable to connections subject to tension load only.

TABLE 2B — REFERENCE WITHDRAWAL DESIGN VALUES (W) FOR PHEINOX™ STAINLESS STEEL FASTENERS<sup>1,2</sup>

FASTENER DESIGNATION	THREAD LENGTH <sup>3</sup> (inches)	W (lbf/in.) FOR SPECIFIC GRAVITIES (SG) OF:			
		SG ≥ 0.67 <sup>4</sup>	0.58 ≥ SG ≥ 0.55	0.55 > SG ≥ 0.49	0.49 > SG ≥ 0.42
R4	9x2"	213	215	179	125
	10x2 1/2"				
	10x2 3/4"	123	240	193	144
	10x3 1/2"				
	10x4"				
FIN/RTM RT COMPOSITE	8x2 1/2"	106	n/a	n/a	n/a
	8x3 1/2"				
	9x2 1/2"	115	n/a	n/a	n/a
	9x2 3/4"				
	9x3 1/2"				
	9x4"				

For SI: 1 inch = 25.4 mm; 1 lbf/in = 178 N/m.

<sup>1</sup>Tabulated reference withdrawal design values (W) are in pounds per inch of thread penetration into side grain of main member.  
<sup>2</sup>Values must be multiplied by applicable adjustment factors, in accordance with the NDS, and must be multiplied by the length of thread penetration in the main member, including tip.  
<sup>3</sup>Where two thread lengths are shown, the first refers to thread length of screws marked with "GRK" on the fastener head, and the second refers to screws which do not have this marking on the head.  
<sup>4</sup>Pilot holes equal to 70% of the root diameter of the screw are required, and the tabulated values are applicable to connections subject to tension load only, due to differing pilot hole requirements for lateral connections.

TABLE 3B— REFERENCE PULL-THROUGH DESIGN VALUES (P) FOR PHEINOX™ STAINLESS STEEL FASTENERS<sup>1</sup>

FASTENER DESIGNATION	MINIMUM SIDE MEMBER THICKNESS (inch)	P (lbf) FOR SPECIFIC GRAVITIES (SG) OF:			
		SG ≥ 0.67 <sup>2</sup>	0.58 ≥ SG ≥ 0.55	0.55 > SG ≥ 0.49	0.49 > SG ≥ 0.42
R4	9x2"	184	119	107	83
	10x2 1/2"				
	10x2 3/4"	220	140	126	103
	10x3 1/2"				
	10x4"				
FIN/RTM RT COMPOSITE	8x2 1/2"	70	n/a	n/a	n/a
	8x3 1/2"				
	9x2 1/2"	124	n/a	n/a	n/a
	9x2 3/4"				
	9x3 1/2"				
	9x4"				

For SI: 1 inch = 25.4 mm; 1 lbf = 4.45 N.

<sup>1</sup>Values must be multiplied by applicable adjustment factors, in accordance with the NDS.  
<sup>2</sup>Pilot holes equal to 90% of the root diameter of the screw are required, and the tabulated values are applicable to connections subject to tension load only.



# FASTENER TECHNICAL DATA

## R4™, Trim™



**TABLE 4A— REFERENCE LATERAL DESIGN VALUES (Z) FOR WOOD-TO-WOOD CONNECTIONS USING CLIMATEK™ COATED FASTENERS<sup>1</sup>**

FASTENER DESIGNATION	SIDE MEMBER THICKNESS (inch)	MINIMUM MAIN MEMBER PENETRATION (inches)	Z (lbf) FOR SPECIFIC GRAVITIES (SG) OF:				
			SG ≥ 0.67 <sup>2</sup>	0.58 ≥ SG ≥ 0.55	0.55 > SG ≥ 0.49	0.49 > SG ≥ 0.42	
R4	9x2"	3/4	1 1/4	175	103	89	75
	9x2 1/2"						
	9x2 3/4"						
	9x3 1/8"						
	10x2 1/2"	3/4	1 3/4	203	121	97	95
	10x2 3/4"						
	10x3 1/8"						
	10x3 1/2"						
	10x4"						
	10x4 3/4"	3/4	4	242	122	119	110
	12x4 3/4"						
	12x5 1/8"						
	12x6 1/8"						
	12x7 1/4"						
12x8"							
12x10"							
12x12"							
FIN/TRIM	8x2 1/2"	3/4	1 3/4	84	—	—	—
	8x2 3/4"						
	8x3 1/8"						
	9x2 1/2"	3/4	1 3/4	104	—	—	—
	9x2 3/4"						
	9x3 1/8"						

For SI: 1 inch = 25.4 mm; 1 lbf = 4.45 N.

<sup>1</sup>Values must be multiplied by applicable adjustment factors, in accordance with the NDS.

<sup>2</sup>Pilot holes equal to 90% of the root diameter of the screw are required, and the tabulated values are applicable to connections subject to lateral load only, due to differing pilot hole requirements for tension connections.

**TABLE 4B— REFERENCE LATERAL DESIGN VALUES (Z) FOR WOOD-TO-WOOD CONNECTIONS USING PHEINOX™ STAINLESS STEEL FASTENERS<sup>1</sup>**

FASTENER DESIGNATION	SIDE MEMBER THICKNESS (inch)	MINIMUM MAIN MEMBER PENETRATION (inches)	Z (lbf) FOR SPECIFIC GRAVITIES (SG) OF:				
			SG ≥ 0.67 <sup>2</sup>	0.67 > SG ≥ 0.55	0.55 > SG ≥ 0.49	0.49 > SG ≥ 0.42	
R4	9x2"	3/4	1 1/4	212	128	110	87
	10x2 1/2"	3/4	1 3/4	235	135	110	102
	10x2 3/4"						
	10x3 1/8"						
	10x4"						
FIN/TRIM	8x2 1/2"	3/4	1 3/4	78	—	—	—
	8x2 3/4"						
	8x3 1/8"						
	9x2 1/2"	3/4	1 3/4	108	—	—	—
	9x2 3/4"						
9x3 1/8"							
RT COMPOSITE	8x2 1/2"	3/4	1 3/4	107	—	—	—
	8x2 3/4"						
	8x3 1/8"						
	9x2 1/2"	3/4	1 3/4	151	—	—	—
	9x2 3/4"						
9x3 1/8"							

For SI: 1 inch = 25.4 mm; 1 lbf = 4.45 N.

<sup>1</sup>Values must be multiplied by applicable adjustment factors, in accordance with the NDS.

<sup>2</sup>Pilot holes equal to 90% of the root diameter of the screw are required, and the tabulated values are applicable to connections subject to lateral load only, due to differing pilot hole requirements for tension connections.

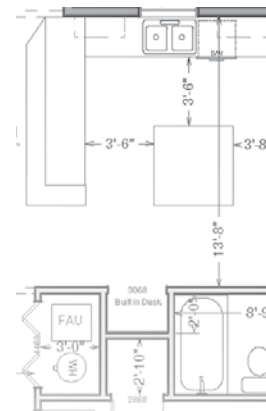

# FASTENER TECHNICAL DATA

## R4™, Trim™

TABLE 5—CONNECTION GEOMETRY REQUIREMENTS<sup>1,2</sup>

CONDITION		MINIMUM DISTANCE OR SPACING (inches)			
		D = 0.111"	D = 0.128-0.134"	D = 0.142"	D = 0.171"
End distance	Loading toward end	2	2	2 <sup>1</sup> / <sub>8</sub>	2 <sup>5</sup> / <sub>8</sub>
	Loading away from end	1 <sup>1</sup> / <sub>8</sub>	1 <sup>1</sup> / <sub>4</sub>	1 <sup>3</sup> / <sub>8</sub>	1 <sup>3</sup> / <sub>4</sub>
	Loading perpendicular to grain	NA <sup>3</sup>	NA <sup>3</sup>	NA <sup>3</sup>	NA <sup>3</sup>
Edge distance	Loading parallel to grain	1	1	1 <sup>1</sup> / <sub>8</sub>	1 <sup>3</sup> / <sub>8</sub>
	Loading perpendicular to grain	NA <sup>3</sup>	NA <sup>3</sup>	NA <sup>3</sup>	NA <sup>3</sup>
Spacing between fasteners in a row	Loading parallel to grain	1 <sup>3</sup> / <sub>4</sub>	2	2 <sup>1</sup> / <sub>8</sub>	2 <sup>5</sup> / <sub>8</sub>
	Loading perpendicular to grain	NA <sup>3</sup>	NA <sup>3</sup>	NA <sup>3</sup>	NA <sup>3</sup>
Spacing between rows	In-line rows	<sup>5</sup> / <sub>8</sub>	<sup>5</sup> / <sub>8</sub>	<sup>3</sup> / <sub>4</sub>	<sup>7</sup> / <sub>8</sub>
	Staggered rows <sup>4</sup>	<sup>1</sup> / <sub>4</sub>	<sup>3</sup> / <sub>8</sub>	<sup>3</sup> / <sub>8</sub>	<sup>3</sup> / <sub>8</sub>

For SI: 1 inch = 25.4 mm.

<sup>1</sup>End distances, edge distances and screw spacing must be sufficient to prevent splitting of the wood, or as required by this table, whichever is the more restrictive. See Section 4.2.

<sup>2</sup>The term *D* is the shank diameter, as specified in Table 1.

<sup>3</sup>Loading perpendicular to grain is outside the scope of this evaluation report.

<sup>4</sup>Values for spacing between staggered rows apply where screws in adjacent rows are offset by half of the spacing between screws in a row.

TABLE 6—EXPOSURE CONDITIONS FOR FASTENERS WITH INTENDED USE AND LIMITATIONS OF RECOGNITION

EXPOSURE CONDITION	TYPICAL APPLICATIONS	RECOGNITION LIMITATIONS
<b>Corrosion Resistance of Fasteners</b>		
1	Treated wood in dry use applications	Limited to use where equilibrium moisture content of the chemically treated wood meets the dry service conditions as described in the NDS.
3	General construction	Limited to freshwater and chemically treated wood exposure, i.e., no saltwater exposure.

### R4

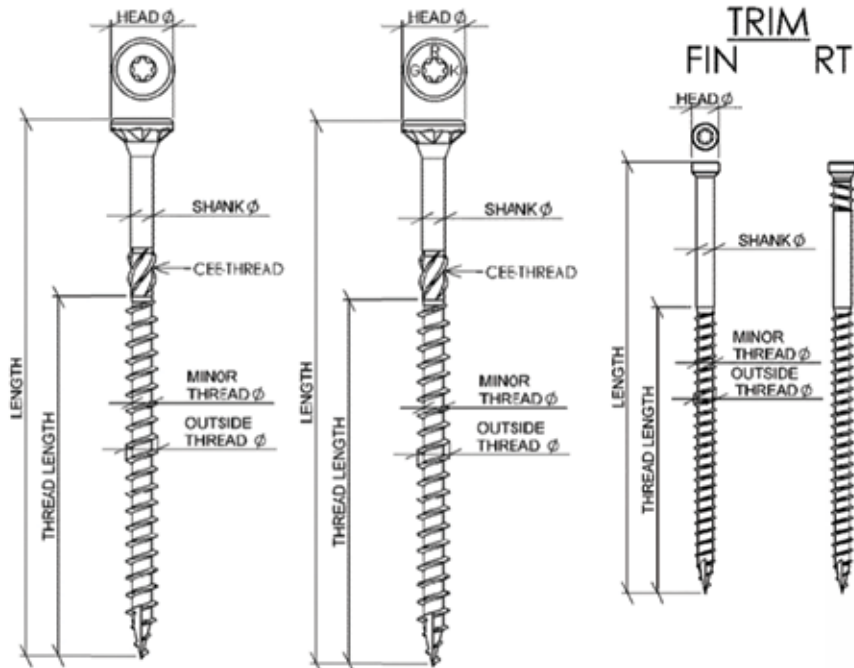





# FASTENER TECHNICAL DATA

## Caliburn™ XL



FOOTING SCHEDULE	
HOUSE WALLS	20
DECKS & PORCHES	18
BEARING WALL	20
GARAGE WALL	18

Min 2 #4 Rebar Horizontal  
on undisturbed or compacted

INSULATION SCHEDULE	
Ceilings	
Wall above grade	

TABLE 1—GRK CALIBURN XL 7.5 SCREW ANCHORS INSTALLATION SPECIFICATIONS

ANCHOR PROPERTY / SETTING INFORMATION	SYMBOL	UNITS	NOMINAL ANCHOR SIZE	
			<sup>19</sup> / <sub>64</sub> INCH (7.5 mm)	
Nominal anchor diameter	$d_a [d_o]^1$	in. (mm)	0.295 (7.5)	
Minimum diameter of hole clearance in fixture	$d_h$	in. (mm)	<sup>5</sup> / <sub>16</sub> (7.9)	
Nominal drill bit diameter	$d_{bit}$	mm	6	
Bit tolerance range	-	mm	6.15 to 6.40	
Maximum impact torque power rating	$T_{impact-max}$	ft-lb. (Nm)	33 (45)	
Screw length	$L$	in. (mm)	3.62 (92)	4.92 (125)
Minimum nominal embedment depth	$h_{nom}$	in. (mm)	2.76 (70)	3.35 (85)
Length of thread	$l_{gew}$	in. (mm)	2.83 (72)	3.43 (87)
Minimum member thickness	$h_{min}$	in. (mm)	4.33 (110)	5.32 (135)
Minimum edge distance	$c_{min} = c_{ac}$	in. (mm)	5.67 (144)	5.67 (144)
Minimum spacing distance	$s_{min}$	in. (mm)	7.56 (192)	7.56 (192)
Minimum hole depth	$h_o$	in. (mm)	3.35 (85)	3.94 (100)

For SI: 1 inch = 25.4 mm, 1 ft-lb = 1.356 N-m.

<sup>1</sup>The notation in brackets is for the 2006 IBC.

### Note:

For safety factor requirements in your area, contact your local building official, architect or engineer. Testing was performed according to ASTM standard E-488-96. **The Caliburn™ XL is on the ICC Report ESR-3251.** For most current information and specifications visit our website: [www.grkfasteners.com](http://www.grkfasteners.com).

## Roof Joist or Roof Truss to Top Plate or Stud Connection

Table 1 Allowable Design Loads for Roof Joist or Roof Truss to Top Plate Connections

Load Type	Screw Type	Wood Species		
		SP (Southern Pine)	DFL (Douglas Fir Larch)	SPF (Spruce Pine Fir)
Allowable Uplift in lbs	Ø3/8 RSS	1230	1017	717
Allowable Shear / Lateral in lbs		528	480	393
Allowable Uplift in lbs	# 12 R4	873	722	509
Allowable Shear / Lateral in lbs		352	322	273
Allowable Uplift in lbs	Ø1/4 LPS/RSS	562	465	328
Allowable Shear / Lateral in lbs		242	221	188

FIGURE 1 Typical Connection Details

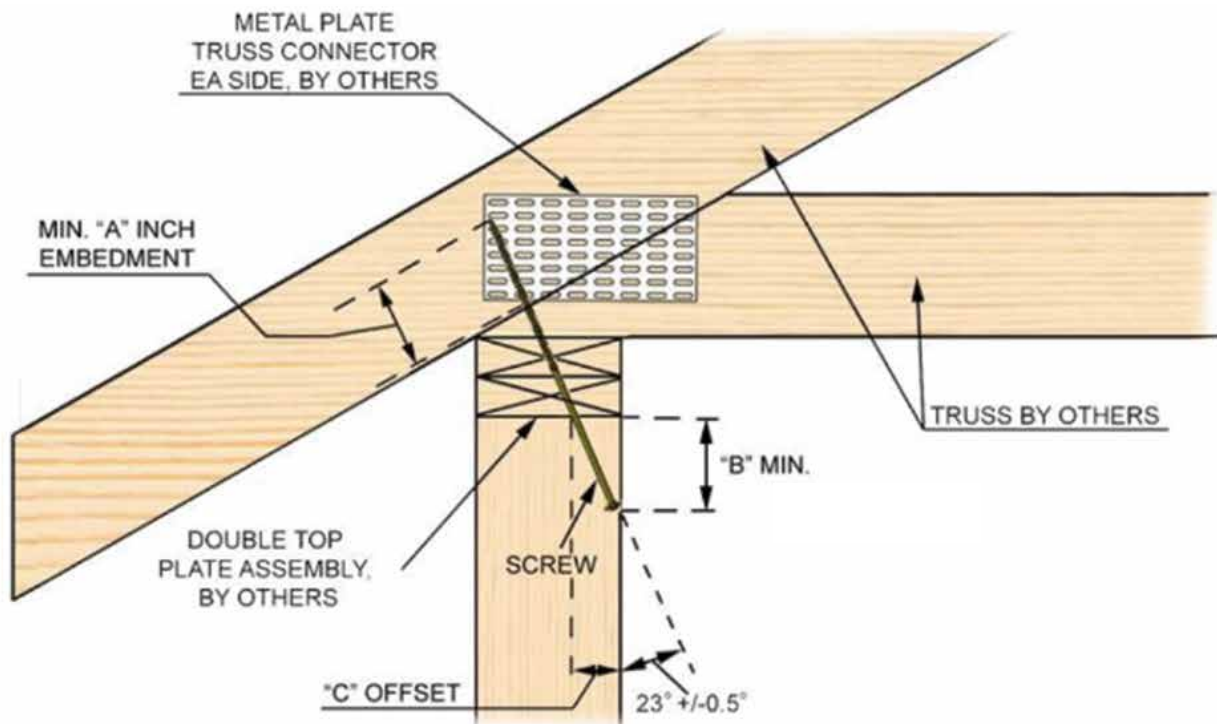

## Multiple Sawn Lumber & Engineered Wood Beams

Table 1 MFR Lumber G=0.5

JTS Screw	# of Screw rows	Fastener Spacing in inches	Allowable Face Mounted Loads Per Foot (PLF)												
			Assembly per Table 3												
			A	B	C	D	E	F							
¼ x 3-3/8"	2	24	212	X	X	X	X	X	X						
	2	16	318												
	2	12	424												
	3	24	318												
	3	16	477												
¼ x 5"	2	24	212	X	X	238	X	X							
	2	16	318						357						
	2	12	424							476					
	3	24	318								357				
	3	16	477									536			
3	12	636	714												
¼ x 6-3/4"	2	24		212	X	X	255	238							
	2	16		318					383	357					
	2	12		424							510		476		
	3	24		318								383		357	
	3	16	477	575											536
	3	12	636												

Note: 1. Applied load from joist are assumed to be uniform  
2. Fastener capacity is based on fastener spacing, not joist spacing

Table 2 Sawn Lumber with Varying Specific Gravity values

RSS	# of Screw rows	Fastener Spacing in inches	Allowable Face Mounted Loads Per Foot (PLF)			
			S.Pine G=0.55	D.Fir G=0.50	SPF G=0.42	Assembly per Table 3
¼ x 2-3/4"	2	24	190	165	127	G
	2	16	285	248	191	
	2	12	380	330	254	
	3	24	285	248	191	
	3	16	428	372	286	
	3	12	570	495	381	
5/16 x 4"	2	24	257	214	210	H
	2	16	386	321	315	
	2	12	514	428	420	
	3	24	386	321	315	
	3	16	578	482	473	
	3	12	771	642	630	
5/16 x 6"	2	24	257	214	210	I
	2	16	386	321	315	
	2	12	514	428	420	
	3	24	386	321	315	
	3	16	578	482	473	
	3	12	771	642	630	

Note: 1. Applied load from joist are assumed to be uniform  
2. Fastener capacity is based on fastener spacing, not joist spacing

Table 3 Assembly Types (Cutting Plane 'A-A' per Fig.3)

MFR Lumber		
A	B	C
2 x 1-3/4"	3 x 1-3/4"	4 x 1-3/4"
D	E	F
1 x 1-3/4" to 3-3/8"	2 x 3-1/2"	1-3/4" ES of 3- 1/2"
Sawn Lumber		
G	H	I
2 x 1-1/2"	3 x 1-1/2"	4 x 1-1/2"

Note: Load should be applied to the face w/the screw head

**ABBREVIATIONS:**

- D.Fir = Douglas Fir-Larch
- ES = each side
- H. Fir = Hem -Fir
- JTS = Joist and Truss Screw
- MFR = Manufactured structural composite lumber
- PLF = Pounds per linear foot
- RSS = Rugged Structural Screw
- SPF = Spruce-Pine-Fir
- S.Pine = Southern Pine
- tm = Thickness of main member
- ts = Thickness of side member
- TYP = Typical
- o.c. = on center

Minimum Spacing Geometry - perpendicular to grain loading

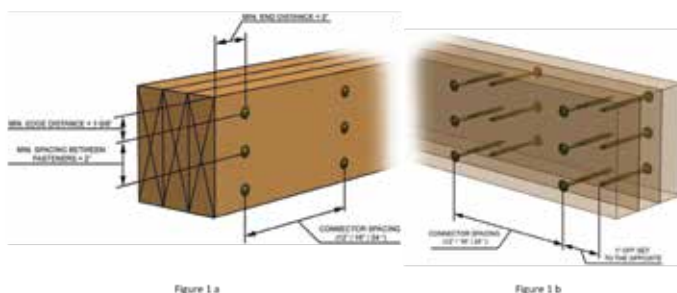

Multi-Ply Beam with One Face Loaded

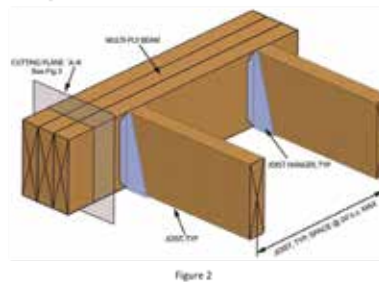

Cutting Plane 'A-A'

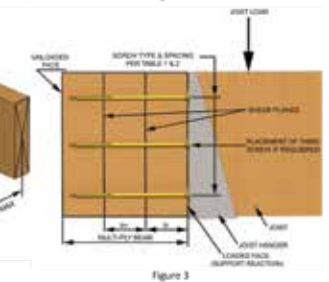

### Multi-Ply Beams w/loads on Both Faces

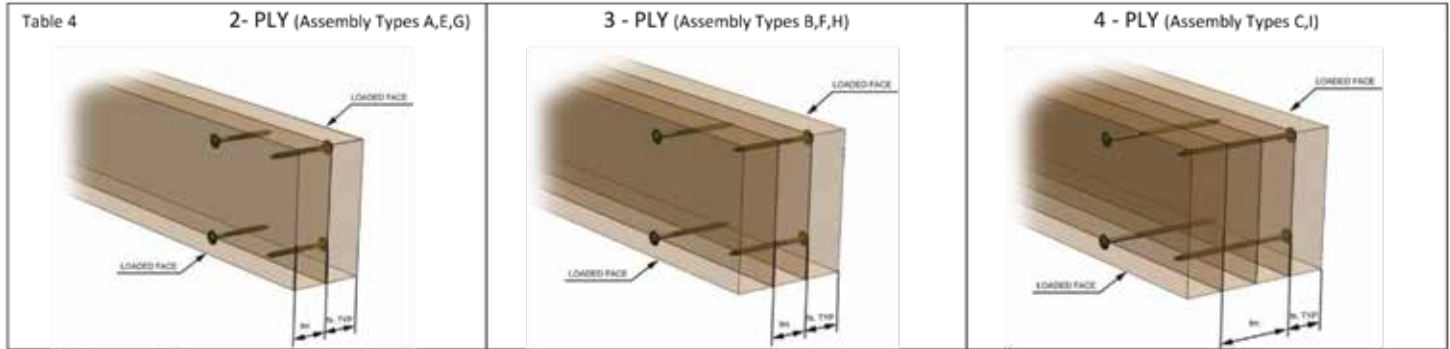

Note: 1. See Tables 1 & 2 for load carrying capacity.  
 2. RSS/JTS screws shall be sized to penetrate laminations from both sides.

### Multi-Ply Beam Point Load

Table 5 MFR Lumber G=0.5

JTS Screw	# Screws	Max Point Load to One Side of Member **					
		A	B	C	D	E	F
1/4 x 3-3/8"	4	848					
	6	1272					
	8	1696					
1/4 x 5"	4		848		952		
	6		1272		1428		
	8		1696		1904		
1/4 x 6-3/4"	4			848		1020	952
	6			1272		1530	1428
	8			1696		2040	1904

Table 6 Sawn Lumber with Varying Specific Gravity values

RSS	# Screws	Max Point Load to One Side of Member **				Assembly
		S.Pine G=0.55	D.Fir G=0.50	SPF G=0.42		
1/4 x 2-3/4"	4	760	660	508	G	
	6	1140	990	762		
	8	1520	1320	1016		
5/16 x 4"	4	1028	856	840	H	
	6	1542	1284	1260		
	8	2056	1712	1680		
5/16 x 6"	4	1028	856	840	I	
	6	1542	1284	1260		
	8	2056	1712	1680		

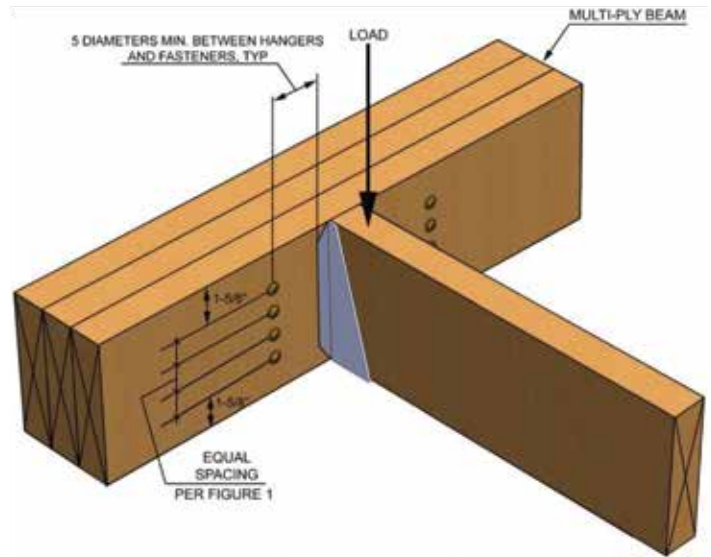

Figure 5

\*\* Note when applying loads on both faces of built up beam, screws determined from table 5 & 6 shall be installed on both sides 1" offset for rows on opposite face.

### Multi-Ply Beam Top-Loaded

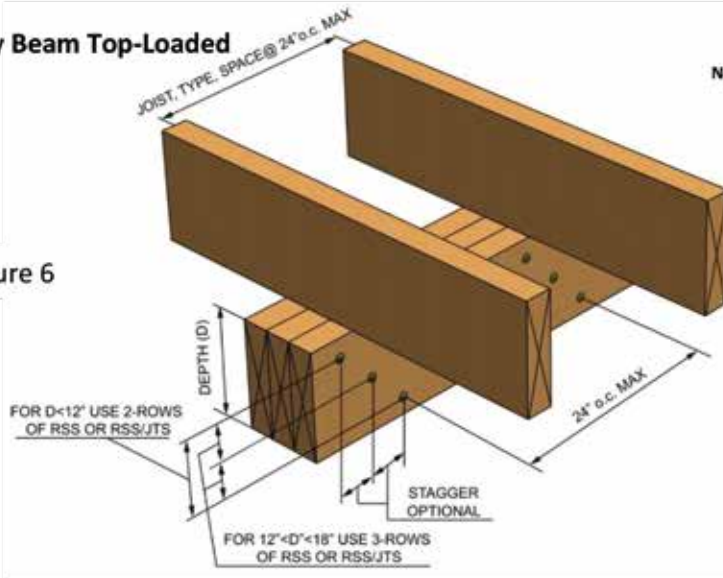

Figure 6

Note: 1. Load must be applied evenly across entire beam width. Otherwise, use connection for side-loaded beams.  
 2. RSS/JTS screw shall be sized to penetrate through all plies  
 3. For beams with 4 or more plies, install screws on both faces 1" offset between rows on opposite faces.

For ICC Report ESR-2442, please visit:  
[www.icc-es.org/reports/pdf-files/icc-es/ESR-2442.pdf](http://www.icc-es.org/reports/pdf-files/icc-es/ESR-2442.pdf)

# Ledger Board: Structural Screw

Table 1

RSS 5/16 x 4"			Joist span				
			6 ft	8 ft	10 ft	12 ft	14 ft
Live load (psf)	Wood Species	Screw Shear Capacity (lb/ft)	Screw Spacing in inches				
40	G= 0.42 / SPF	182	14	10	8	7	6
40	G = 0.50 / DF-PSL-LVL-LSV	213	17	12	10	8	7
40	G = 0.55 / SP	252	20	15	12	10	8
60	G= 0.42 / SPF	182	10	7	6	5	4
60	G = 0.50 / DF-PSL-LVL-LSV	213	12	9	7	6	5
60	G = 0.55 / SP	252	14	10	8	7	6

NOTE: 1. Deck Dead Load = 10 psf

Table 2 (wet-use in- service)

RSS 5/16 x 4"			Joist span				
			6 ft	8 ft	10 ft	12 ft	14 ft
Live load (psf)	Wood Species	Screw Shear Capacity (lb/ft)	Screw Spacing in inches/ <u>wet-use in- service</u>				
40	G= 0.42 / SPF	127	10	7	6	5	4
40	G = 0.50 / DF-PSL-LVL-LSV	150	12	9	7	6	5
40	G = 0.55 / SP	176	14	10	8	7	6
60	G= 0.42 / SPF	127	7	5	4	3	3
60	G = 0.50 / DF-PSL-LVL-LSV	150	8	6	5	4	3
60	G = 0.55 / SP	176	10	7	6	5	4

NOTE: 1. Deck Dead Load = 10 psf

Table 3

PHEINOX RSS 5/16 x 4"(Stainless steel)			Joist span				
			6 ft	8 ft	10 ft	12 ft	14 ft
Live load (psf)	Wood Species	Screw Shear Capacity (lb/ft)	Screw Spacing in inches				
40	G= 0.42 / SPF	151	12	9	7	6	5
40	G = 0.50 / DF-PSL-LVL-LSV	187	14	11	8	7	6
40	G = 0.55 / SP	204	16	12	9	8	6
60	G= 0.42 / SPF	151	8	6	5	4	3
60	G = 0.50 / DF-PSL-LVL-LSV	187	10	8	6	5	4
60	G = 0.55 / SP	204	11	8	6	5	4

NOTE: 1. Deck Dead Load = 10 psf

Table 4 (wet-use in- service)

PHEINOX RSS 5/16 x 4"(Stainless steel)			Joist span				
			6 ft	8 ft	10 ft	12 ft	14 ft
Live load (psf)	Wood Species	Screw Shear Capacity (lb/ft)	Screw Spacing in inches/ <u>wet-use in- service</u>				
40	G= 0.42 / SPF	106	8	6	5	4	3
40	G = 0.50 / DF-PSL-LVL-LSV	131	10	7	6	5	4
40	G = 0.55 / SP	143	11	8	6	5	4
60	G= 0.42 / SPF	106	6	4	3	3	2
60	G = 0.50 / DF-PSL-LVL-LSV	131	7	5	4	3	3
60	G = 0.55 / SP	143	8	6	4	4	3

NOTE: 1. Deck Dead Load = 10 psf

Table 5 Wood Species Specific Gravities

Species	Specific Gravity (G)
Spruce-Pine Fir (SPF)	G = 0.42
Hem-Fir (HF)	G = 0.43
Douglas Fir Larch (DFL)	G = 0.50
Parallel Strand Lumber (PSL)	G = 0.50
Laminated Veneer Lumber (LVL)	G = 0.50
Laminated Strand Lumber (LSL)	G = 0.50
Southern Pine (SP)	G = 0.55

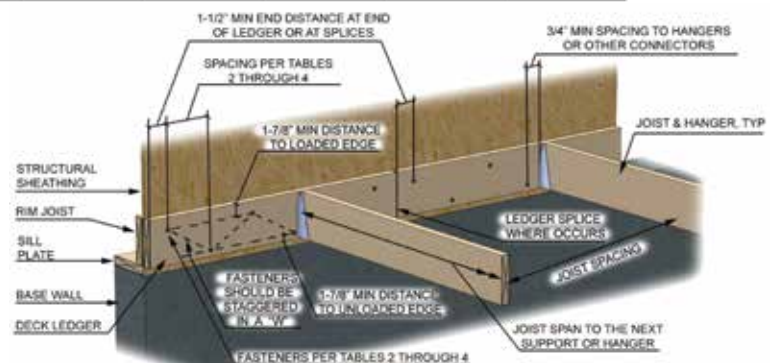

**TABLE 2—TENSION STRENGTH DESIGN INFORMATION FOR TAPCON® SCREW ANCHOR<sup>1</sup>**

CHARACTERISTIC	SYMBOL <sup>5</sup>	UNITS	NOMINAL ANCHOR DIAMETER (inch) <sup>4</sup>	
			<sup>3</sup> / <sub>16</sub>	<sup>1</sup> / <sub>4</sub>
Head Style	—	—	Hex Head/ Phillips Head	Hex Head/ Phillips Head
Drill bit specification		in.	<sup>5</sup> / <sub>32</sub> Tapcon® Bit	<sup>3</sup> / <sub>16</sub> Tapcon® Bit
Anchor category	1, 2 or 3	—	1	1
Effective embedment depth	$h_{ef}$	in.	1.50	1.50
Minimum concrete member thickness	$h_{min}$	in.	4	4
Critical edge distance	$c_{ac}$	in.	4	4
<b>Data for Steel Strength in Tension</b>				
Minimum specified yield strength	$f_y$	psi	100,000	100,000
Minimum specified ultimate strength	$f_{uta} (f_{ud})^5$	psi	125,000	125,000
Effective tensile stress area	$A_{se}$	in <sup>2</sup>	0.0147	0.0241
Steel strength in tension	$N_{sa}$	lbf	2,025	3,800
Strength reduction factor $\phi$ for tension, steel failure modes <sup>2</sup>	$\phi_{sa}$	—	0.65	0.65
<b>Data for Concrete Breakout Strength in Tension</b>				
Effectiveness factor -uncracked concrete	$k_{unscr}$	—	24	24
Modification factor for cracked and uncracked concrete <sup>3</sup>	$\psi_{c,N} (\psi_c)^4$	—	1.0	1.0
Strength reduction factor $\phi$ for tension, concrete failure modes, Condition B <sup>3</sup>	$\phi_{cb}$	—	0.65	0.65
<b>Data for Pullout Strength in Tension</b>				
Pullout strength, uncracked concrete	$N_{p,unscr}$	lbf	590	795
Strength reduction factor $\phi$ for tension, pullout failure modes, Condition B <sup>3</sup>	$\phi_p$	—	0.65	0.65
<b>Additional Anchor Data</b>				
Axial stiffness in service load range in uncracked concrete	$\beta_{unscr}$	lbf/in	317,000	467,000

For SI: 1 inch = 25.4 mm, 1 ft-lbf = 1.356 N-m.

**TABLE 3—SHEAR STRENGTH DESIGN INFORMATION FOR TAPCON® SCREW ANCHOR<sup>1</sup>**

CHARACTERISTIC	SYMBOL <sup>5</sup>	UNITS	NOMINAL ANCHOR DIAMETER (inch) <sup>4</sup>	
			<sup>3</sup> / <sub>16</sub>	<sup>1</sup> / <sub>4</sub>
Head Style	—	—	Hex Head/Phillips Head	Hex Head/Phillips Head
Drill bit specification		in.	<sup>5</sup> / <sub>32</sub> Tapcon® Bit	<sup>3</sup> / <sub>16</sub> Tapcon® Bit
Anchor category	1, 2 or 3	—	1	1
Effective embedment depth	$h_{ef}$	in.	1.50	1.50
Minimum concrete member thickness	$h_{min}$	in.	4	4
Critical edge distance	$c_{ac}$	in.	4	4
<b>Data for Steel Strengths in Shear</b>				
Minimum specified yield strength	$f_y$	psi	100,000	100,000
Minimum specified ultimate strength	$f_{uta} (f_{ud})^4$	psi	125,000	125,000
Effective shear stress area	$A_{se}$	in <sup>2</sup>	0.0147	0.0241
Steel strength in shear - static	$V_{sa}$	lbf	715	1,300
Strength reduction factor $\phi$ for shear, steel failure modes <sup>2</sup>	$\phi_{sa}$	—	0.60	0.60
<b>Data for Concrete Breakout and Concrete Pryout Strengths in Shear</b>				
Nominal Outside diameter (shank)	$d_s (d_o)^4$	in.	0.15	0.19
Load bearing length of anchor	$\ell_e$	—	1.50	1.50
Coefficient for Pryout Strength	$\kappa_{cp}$	—	1.0	1.0
Strength reduction factor for shear, concrete breakout <sup>3</sup>	$\phi_{cb}$	—	0.70	0.70
Strength reduction factor for shear, pryout <sup>3</sup>	$\phi_{cp}$	—	0.70	0.70

For SI: 1 inch = 25.4 mm, 1 ft-lbf = 1.356 N-m.

TABLE 1—INSTALLATION INFORMATION FOR TAPCON+ SCREW ANCHORS

CHARACTERISTIC	SYMBOL	UNITS	NOMINAL ANCHOR DIAMETER (inch)					
			1/4		3/8		1/2	
Head Style	—	—	Hex Head		Hex Head		Hex Head	
Nominal Outside diameter (Shank)	$d_s, d_o$	in.	0.25		0.38		0.50	
Nominal Outside diameter (threads)	—	in.	0.33		0.46		0.59	
Drill bit specification	$d_{bit}$	in.	1/4 Tapcon+ Bit	1/4 Tapcon+ Bit	1/4 ANSI Bit	3/8 ANSI Bit	1/2 ANSI Bit	
Minimum base plate clearance hole diameter	$d_b$	in.	Not applicable <sup>2</sup>		3/8	1/2	5/8	
Maximum installation torque <sup>6</sup>	$T_{inst, max}$	ft-lbf	Not applicable <sup>4</sup>		20	50	70	
Maximum Impact Wrench Torque Rating	$T_{impact, max}$	ft-lbf	Not applicable <sup>4</sup>		115	200	345	
Effective embedment depth	$h_{ef}$	in.	1.67	1.45	1.78	1.32	2.17	3.02
Minimum nominal embedment depth <sup>5</sup>	$h_{nom}$	in.	2 1/4	2	2 1/2	2	3	4
Minimum hole depth	$h_{hole}$	in.	2 1/2	2 1/4	2 3/4	2 1/4	3 1/4	4 1/4
Minimum concrete member thickness	$h_{min}$	in.	4	4	4	4	6	
Critical edge distance	$c_{ac}$	in.	2 1/2	2 1/2	4 1/2	3	4	5
Minimum edge distance	$c_{min}$	in.	1 1/2	1 1/2	1 1/2	2 1/2	1 3/4	2 1/2
Minimum spacing	$s_{min}$	in.	3	3	3	3	3 1/2	3

For SI: 1 inch = 25.4 mm, 1 ft-lbf = 1.356 N-m.



TABLE 2—TENSION STRENGTH DESIGN INFORMATION FOR TAPCON+ SCREW ANCHORS

CHARACTERISTIC	SYMBOL	UNITS	NOMINAL ANCHOR DIAMETER (inch)						
			1/4		3/8		1/2		
Head Style	—	—	Hex Head		Hex Head		Hex Head		
Drill bit specification		in.	1/4 Tapcon+ Bit	1/4 Tapcon+ Bit	1/4 ANSI Bit	3/8 ANSI Bit	1/2 ANSI Bit		
Anchor category	1, 2 or 3	—	1	1	2	1	1		
Effective embedment depth	$h_{ef}$	in.	1.45 <sup>1</sup>		1.45	1.78	1.32	2.17	3.02
Minimum concrete member thickness	$h_{min}$	in.	4		4	4	4	6	
Critical edge distance	$c_{ac}$	in.	2 1/2		2 1/2	4 1/2	3	4	5
Data for Steel Strength in Tension									
Minimum specified yield strength	$f_y$	psi	Not applicable		100,000	100,000	100,000		
Minimum specified ultimate strength	$f_u (f_{ut})^5$	psi	Not applicable		125,000	125,000	125,000		
Effective tensile stress area	$A_{st}$	in <sup>2</sup>	Not applicable		0.0470	0.098	0.1850		
Steel strength in tension	$N_{st}$	lbf	1,822 <sup>7</sup>		5,900	12,250	23,125		
Strength reduction factor $\phi$ for tension, steel failure modes <sup>2</sup>	$\phi_s$	—	0.65		0.65	0.65	0.65		
Data for Concrete Breakout Strength in Tension									
Effectiveness factor - uncracked concrete	$k_{con}$	—	24	24	27	30			
Effectiveness factor - cracked concrete	$k_{cr}$	—	17	17	17	17			
Modification factor for cracked and uncracked concrete <sup>3</sup>	$\psi_{c,1} (\psi_c)^3$	—	1.0		1.0	1.0	1.0		
Strength reduction factor $\phi$ for tension, concrete failure modes, Condition B <sup>1</sup>	$\phi_b$	—	0.65	0.65	0.55	0.65	0.65		
Data for Pullout Strength in Tension									
Pullout strength, uncracked concrete	$N_{p,uncr}$	lbf	2,107		2,107	See Footnote 4	See Footnote 4		
Pullout strength, cracked concrete	$N_{p,cr}$	lbf	857		857	1,837	See Footnote 4		
Pullout strength for seismic loads	$N_{p,se}$	lbf	857		857	1,677	See Footnote 4		
Strength reduction factor $\phi$ for tension, pullout failure modes, Condition B <sup>1</sup>	$\phi_p$	—	0.65		0.65	0.55	0.65	See Footnote 4	
Additional Anchor Data									
Axial stiffness in service load range in uncracked concrete	$\beta_{uncr}$	lbf/in	385,000		385,000	600,000	600,000		
Axial stiffness in service load range in cracked concrete	$\beta_{cr}$	lbf/in	225,000		225,000	365,000	365,000		

For SI: 1 inch = 25.4 mm, 1 ft-lbf = 1.356 N-m.

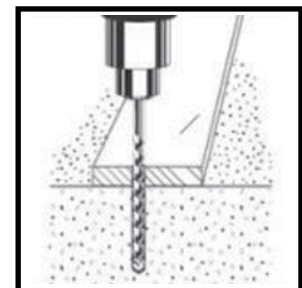

1

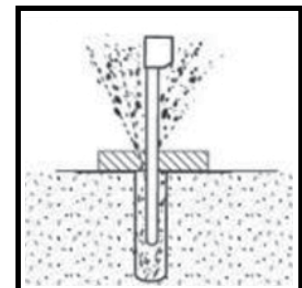

2

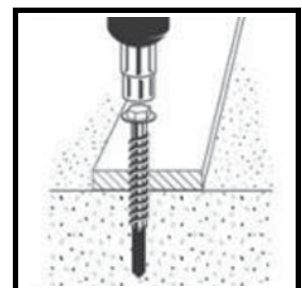

3

TABLE 3—SHEAR STRENGTH DESIGN INFORMATION FOR TAPCON+ SCREW ANCHORS

CHARACTERISTIC	SYMBOL	UNITS	NOMINAL ANCHOR DIAMETER (inch)					
			1/4	1/4	3/8	1/2		
Head Style	—	—		Hex Head	Hex Head	Hex Head		
Drill bit specification		in.	1/4 Tapcon+ Bit	1/4 Tapcon+ Bit	1/4 ANSI Bit	3/8 ANSI Bit	1/2 ANSI Bit	
Anchor category	1, 2 or 3	—	1	1	2	1	1	
Minimum effective embedment depth	$h_{ef}$	in.	1.45 <sup>6</sup>	1.45	1.78	1.32	2.17	3.02
Minimum concrete member thickness	$h_{min}$	in.	4	4	4	4	6	
Critical edge distance	$c_{ac}$	in.	2 1/2	2 1/2	4 1/2	3	4	5
<b>Data for Steel Strengths in Shear</b>								
Minimum specified yield strength	$f_y$	psi	Not applicable	100,000	100,000	100,000		
Minimum specified ultimate strength	$f_{usa} (f_{ud})^4$	psi	Not applicable	125,000	125,000	125,000		
Effective shear stress area	$A_{se}$	in <sup>2</sup>	Not applicable	0.047	0.098	0.185		
Steel strength in shear - static	$V_{sa}$	lbf	905 <sup>7</sup>	2,045	3,621	12,610		
Steel strength in shear - seismic	$V_{sa,eq}$		Not applicable <sup>5</sup>	1,350	2,920	9,300		
Strength reduction factor $\phi$ for shear, steel failure modes <sup>2</sup>	$\phi_{sa}$	—	0.60	0.60	0.60	0.60		
<b>Data for Concrete Breakout and Concrete Pryout Strengths in Shear</b>								
Nominal Outside diameter (shank)	$d_s (d_o)^4$	in.	0.25	0.25	0.38	0.50		
Load bearing length of anchor	$\ell_e$	—	1.67	1.45	1.78	1.32	2.17	3.02
Coefficient for Pryout Strength	$\kappa_{cp}$	—	1.0	1.0	1.0	1.0		2.0
Strength reduction factor for shear, concrete breakout <sup>3</sup>	$\phi_{cb}$	—	0.70	0.70	0.70	0.70		
Strength reduction factor for shear, pryout <sup>3</sup>	$\phi_{cp}$	—	0.70	0.70	0.70	0.70		

For SI: 1 inch = 25.4 mm, 1 ft-lbf = 1.356 N-m.

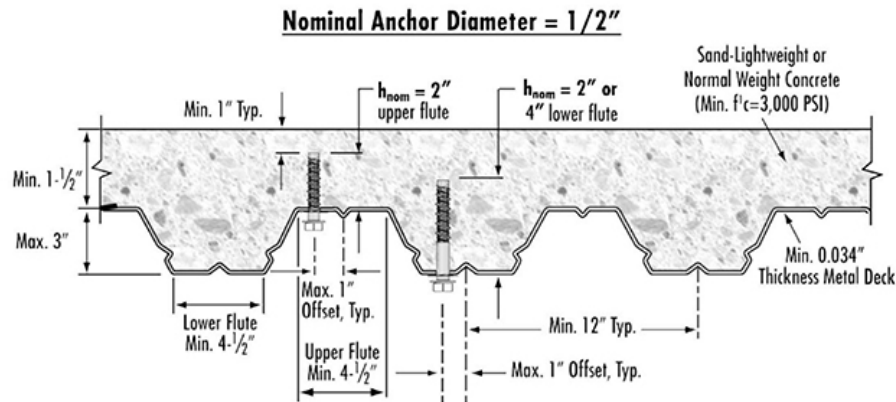

FIGURE 6—TAPCON+ SCREW ANCHOR LOCATED IN THE SOFFIT OF CONCRETE OVER STEEL DECK FLOOR AND ROOF ASSEMBLIES (1 inch = 25.4 mm)



**TABLE 2—CONCRETE BREAKOUT DESIGN INFORMATION FOR U.S. CUSTOMARY UNIT THREADED ROD <sup>(1)</sup>**

CHARACTERISTIC	SYMBOL	UNITS	NOMINAL ROD DIAMETER (inch)						
			$\frac{3}{8}$	$\frac{1}{2}$	$\frac{5}{8}$	$\frac{3}{4}$	$\frac{7}{8}$	1	$1\frac{1}{4}$
Effectiveness factor for uncracked concrete	$k_{uncr}$	-	24	24	24	24	24	24	24
Effectiveness factor for cracked concrete	$k_{cr}$	-	17	17	17	17	17	17	17
Minimum concrete thickness	$h_{min}$	in.	$h_{ef} + 1\frac{1}{4}$			$h_{ef} + 2d_o$			
Anchor embedment depth - minimum	$h_{ef,min}$	in.	$2\frac{3}{8}$	$2\frac{3}{4}$	$3\frac{1}{8}$	$3\frac{1}{2}$	$3\frac{1}{2}$	4	5
Minimum spacing	$s_{min}$	in.	$1\frac{5}{16}$	$1\frac{1}{2}$	$2\frac{1}{2}$	3	$3\frac{1}{2}$	4	5
Minimum edge distance	$c_{min}$	in.	$1\frac{5}{16}$	$1\frac{1}{2}$	$2\frac{1}{2}$	3	$3\frac{1}{2}$	4	5
Critical edge distance	$c_{ce}$	in.	See Section 4.1.10 of this report						
Strength reduction factor for tension, concrete failure mode <sup>1</sup>	$\phi$	Cond. B	0.65	0.65	0.65	0.65	0.65	0.65	0.65
Strength reduction factor for shear, concrete failure mode <sup>1</sup>	$\phi$	Cond. B	0.70	0.70	0.70	0.70	0.70	0.70	0.70

For SI: 1 inch = 25.4mm, 1 lbf = 4.45N, 1ft-lbf = 1.356 N-M, 1 psi = 0.006895 MPa.

**TABLE 3—RED HEAD EPCON A7+ ADHESIVE ANCHOR BOND STRENGTH DESIGN INFORMATION FOR U.S. CUSTOMARY UNIT THREADED ROD <sup>(1,4)</sup>**

CHARACTERISTIC	SYMBOL	UNITS	NOMINAL ROD DIAMETER (inch)							
			$\frac{3}{8}$	$\frac{1}{2}$	$\frac{5}{8}$	$\frac{3}{4}$	$\frac{7}{8}$	1	$1\frac{1}{4}$	
Anchor embedment depth - minimum	$h_{ef}$	in.	$2\frac{3}{8}$	$2\frac{3}{4}$	$3\frac{1}{8}$	$3\frac{1}{2}$	$3\frac{1}{2}$	4	5	
Anchor embedment depth - maximum	$h_{ef}$	in.	$7\frac{1}{2}$	10	$12\frac{1}{2}$	15	$17\frac{1}{2}$	20	25	
Temperature Range A <sup>2</sup>	Characteristic Bond Strength for Uncracked Concrete	$T_{k,uncr}$	psi	1,770	1,770	1,770	1,770	1,490	1,490	1,490
	Characteristic Bond Strength for Cracked Concrete	$T_{k,cr}$	psi	1,060	790	860	890	695	655	585
Temperature Range B <sup>3</sup>	Characteristic Bond Strength for Uncracked Concrete	$T_{k,uncr}$	psi	1,275	1,275	1,275	1,275	1,080	1,080	1,080
	Characteristic Bond Strength for Cracked Concrete	$T_{k,cr}$	psi	765	570	620	640	500	475	420
Continuous Inspection	Strength Reduction Factor - Dry Concrete	$\phi_{dry, ci}$	-	0.65	0.65	0.65	0.65	0.65	0.65	0.65
	Strength Reduction Factor - Water-Saturated Concrete	$\phi_{sat, ci}$	-	0.65	0.65	0.65	0.65	0.65	0.65	0.65
	Strength Reduction Factor - Water-Filled Holes	$\phi_{wf, ci}$	-	0.65	0.65	0.65	0.65	0.65	0.65	0.65
	Strength Reduction Factor - Submerged Concrete	$\phi_{sub, ci}$	-	0.65	0.55	0.55	0.65	0.65	0.55	0.65
Periodic Inspection	Strength Reduction Factor - Dry Concrete	$\phi_{dry, pi}$	-	0.55	0.55	0.55	0.55	0.55	0.55	0.65
	Strength Reduction Factor - Water-Saturated Concrete	$\phi_{sat, pi}$	-	0.65	0.65	0.65	0.65	0.65	0.65	0.65
	Strength Reduction Factor - Water-Filled Holes	$\phi_{wf, pi}$	-	0.65	0.65	0.65	0.65	0.65	0.65	0.65
	Strength Reduction Factor - Submerged Concrete	$\phi_{sub, pi}$	-	0.65	0.45	0.45	0.65	0.55	0.45	0.65
Reduction factor for seismic tension	$\alpha_{N,seis}$	-	0.89	0.75	0.76	0.66	0.77	0.80	0.80	

For SI: 1 inch = 25.4mm, 1 lbf = 4.45N, 1ft-lbf = 1.356 N-M, 1 psi = 0.006895 MPa.

TABLE 2—ITW RED HEAD TRUBOLT WEDGE ANCHOR INSTALLATION INFORMATION

	SYMBOL	UNITS	NOMINAL ANCHOR DIAMETER (in.)					
			1/4		3/8		1/2	
Anchor outer diameter	$d_a$	in. (mm)	0.25 (6.4)		0.375 (9.5)		0.5 (12.7)	
Nominal carbide bit diameter	$d_{bit}$	in. (mm)	1/4		3/8		1/2	
Effective embedment depth	$h_{ef}$	in. (mm)	1 1/2 (38)	2 (51)	1 3/4 (44)	2 5/8 (67)	1 7/8 (48)	3 3/8 (86)
Nominal Embedment depth	$h_{nom}$	in. (mm)	1 3/4 (44)	2 1/4 (57)	2 1/4 (57)	3 1/8 (79)	2 1/2 (64)	4 (102)
Minimum hole depth	$h_o$	in. (mm)	2 (51)	2 1/2 (64)	2 1/2 (64)	3 3/8 (86)	2 3/4 (70)	4 1/4 (108)
Minimum concrete member thickness	$h_{min}$	in. (mm)	4 (102)		4 (102)	5 (127)	5 (127)	6 (152)
Critical edge distance	$c_{ac}$	in. (mm)	2 5/8 (67)	3 (76)	2 5/8 (67)	5 1/4 (133)	3 3/4 (95)	6 3/4 (171)
Minimum edge distance	$c_{min}$	in. (mm)	1 3/4 (44)	1 1/2 (38)	2 1/4 (57)	2 (51)	3 3/4 (95)	3 3/4 (95)
Minimum anchor spacing	$s_{min}$	in. (mm)	1 3/4 (44)	1 1/2 (38)	2 1/4 (57)	2 (51)	3 3/4 (95)	3 3/4 (95)
Installation torque	$T_{inst}$	ft-lb (N-m)	4 (5)		25 (34)		55 (75)	
Reference (attachment) hole diameter	$d_h$	in. (mm)	5/16 (7.9)		7/16 (11.1)		9/16 (14.3)	

TABLE 3—ITW TRUBOLT WEDGE ANCHOR DESIGN INFORMATION<sup>2,3</sup>

DESIGN INFORMATION	SYMBOL	UNITS	NOMINAL ANCHOR DIAMETER					
			1/4		3/8		1/2	
Anchor O.D.	$d_a$	in. mm	0.250 6.4		0.375 9.5		0.500 12.7	
Effective min. embedment	$h_{ef}$	in. mm	1 1/2 38	2 51	1 3/4 44	2 1/2 67	1 1/2 48	3 3/8 86
Minimum member thickness	$h_{min}$	in. mm	4 102		4 102	5 127	5 127	6 152
Installation Torque	$T_{inst}$	ft-lb N-m	4 5		25 34		55 75	
Critical edge distance	$c_{ac}$	in. mm	2 5/8 67	3 76	2 5/8 67	5 1/4 133	3 3/4 95	6 3/4 171
Minimum edge distance	$c_{min}$	in. mm	1 3/4 44	1 1/2 38	2 1/4 57	2 51	3 3/4 95	3 3/4 95
Minimum anchor spacing	$s_{min}$	in. mm	1 3/4 44	1 1/2 38	2 1/4 57	2 51	3 3/4 95	3 3/4 95
Min. hole depth in concrete	$h_o$	in. mm	2 51	2 1/2 64	2 1/2 64	3 3/8 86	2 3/4 70	4 1/4 108
Min. Specified Yield Strength	$f_y$	lb/in <sup>2</sup> N/mm <sup>2</sup>	55,000 379					
Min. Specified Ultimate Strength	$f_u$	lb/in <sup>2</sup> N/mm <sup>2</sup>	75,000 517					
Effective tensile stress area	$A_{st,t}$	in <sup>2</sup> mm <sup>2</sup>	0.032 20.5		0.078 50.0		0.142 91.5	
Effective shear stress area	$A_{st,v}$	in <sup>2</sup> mm <sup>2</sup>	0.032 20.5		0.078 50.0		0.142 91.5	
Steel strength in tension	$N_{st,t}$	lb kN	2385 10.6		5815 25.9		10645 47.3	
Steel strength in shear	$V_{st}$	lb kN	1430 6.4		2975 13.2		4450 19.8	
Pullout strength, uncracked concrete	$N_{con}$	lb kN	See Table 4					

TABLE 3—ITW TRUBOLT WEDGE ANCHOR DESIGN INFORMATION<sup>2,3</sup>

DESIGN INFORMATION	SYMBOL	UNITS	NOMINAL ANCHOR DIAMETER					
			1/4		3/8		1/2	
Anchor O.D.	$d_a$	in. mm	0.250 6.4		0.375 9.5		0.500 12.7	
Anchor Category			1					
Effectiveness factor $k_{con}$ , uncracked concrete <sup>3</sup>			24					
Coefficient for pryout strength	$k_{pr}$	-	1.0	1.0	1.0	2.0	1.0	2.0
Axial stiffness in service load range	$\beta$	lb/in kN/mm	14,651 2.6	9,385 1.6	17,515 3.1	26,424 4.6	32,483 5.7	26,136 4.6
Coefficient of variation for axial stiffness in service load range			34	47	28	45	17	33
Strength reduction factor for tension, steel failure modes	$\phi$	—	0.75					
Strength reduction factor for shear, steel failure modes	$\phi$	—	0.65					
Strength reduction factor for tension, concrete failure modes, Condition B <sup>1</sup>	$\phi$	—	0.65					
Strength reduction factor for shear, concrete failure modes, Condition B <sup>1</sup>	$\phi$	—	0.70					

For SI: 1 inch = 25.4 mm, 1 lbf = 4.45 N, 1 psi = 0.006895 MPa. For pound-inch units: 1 mm = 0.03937 inch.

TABLE 4—ITW TRUBOLT WEDGE ANCHOR PULLOUT STRENGTH,  $N_{con}$ <sup>1,2</sup>

NOMINAL ANCHOR DIAMETER (in.)	EFFECTIVE EMBEDMENT DEPTH (in.)	CONCRETE COMPRESSIVE STRENGTH			
		$f_c = 2,500$ psi	$f_c = 3,000$ psi	$f_c = 4,000$ psi	$f_c = 6,500$ psi
1/4	1 1/2	1,392	1,525	1,610	1,822
	2	1,706	1,869	1,947	2,151
3/8	1 1/2	2,198	2,408	2,621	3,153
	2 1/2	3,469	3,800	3,936	4,275
1/2	1 1/2	2,400	2,629	3,172	4,520
	3 1/2	4,168	4,520	4,520	4,520

For SI: 1 inch = 25.4 mm, 1 lbf = 4.45 N, 1 psi = 0.006895 MPa.

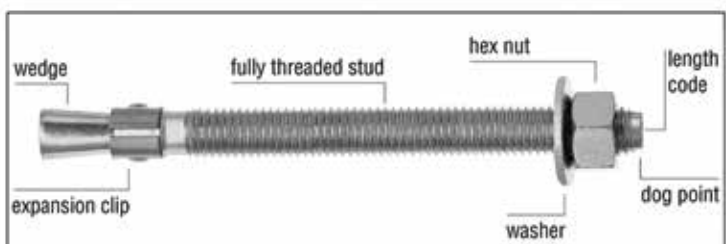
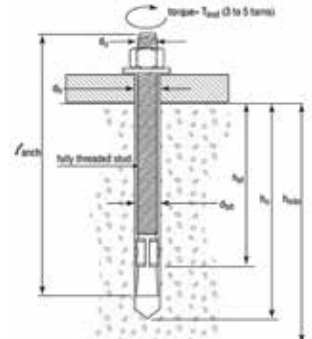

FIGURE 1—ITW RED HEAD TRUBOLT WEDGE ANCHOR





## **LIABILITY AND WARRANTIES**

GRK Fasteners™ is a distributor of commercial grade fasteners. Conformance to “IFI” specifications is formally requested from our suppliers. The parts that we supply are quality inspected by independent labs.

We maintain lot traceability on all products listed in this catalog as long as they are in their original bulk boxes. Certifications are maintained on all fasteners.

**Hydrogen Embrittlement:** We require our platers and suppliers of plated fasteners to bake case hardened parts to “IFI” specifications. However, this process does not guarantee that hydrogen embrittlement will not still be present after baking or that it will not occur at a later date while in service. Specialized testing or a substitute part may be required, depending on the application.

**Liability:** Claims against GRK Fasteners™ shall be limited to a refund or credit for the price billed or paid for faulty or incorrect merchandise. Seller shall not be responsible for buyer's manufacturing costs, labor, alternate purchases, extra freight, replating, plating, lost profit, good will, recall costs, or other incidental or consequential damages.

**Warranties:** GRK Fasteners™ (“GRK”) warrants to the first retail purchaser that its Climatek™ coated and PHEINOX™ stainless steel screws will not rust under normal environmental conditions when used in accordance with the recommendations listed in GRK's Screw Selection Guide for the life of the project. This warranty is not transferable. Visit [www.grkfasteners.com](http://www.grkfasteners.com) for more information.

**Mechanical Fastening Warranty:** (Includes Tapcon, Red Head, Ramset, Teks, Rock-On, Backer-On, and E-Z Ancor). ITW Brands warrants that this product is free from defects in material and workmanship. ITW Brands’ sole liability for any breach of this warranty shall be to replace this product or refund the purchase price.

**Refunds:** In order to receive a refund, the customer must return to us at least 50 of the defective screws (including screw heads) for verification.

THERE ARE NO UNDERSTANDINGS, AGREEMENTS, REPRESENTATIONS OR ADDITIONAL WARRANTIES, EXPRESSED OR IMPLIED (INCLUDING ANY REGARDING WARRANTIES OF MERCHANTABILITY OR FITNESS FOR A PARTICULAR PURPOSE), NOT SPECIFIED HEREIN, RESPECTING ANY SALE OF PRODUCTS BY GRK FASTENERS™, (TO THE EXTENT PERMITTED BY LAW).



**BACKER-ON. ROCK-ON.**



ITW Construction  
Residential & Renovation  
155 Harlem Ave., Building N3E  
Glenview, IL 60025

