

BOSTITCH®



TOOLS & FASTENERS CATALOGUE



FIRST CLASS TOOLS & FASTENERS

BOSTITCH - world class knowledge & experience in construction...

Since 1896, BOSTITCH has been designing and manufacturing tools and fasteners for a wide variety of applications and industries.

With over 500 million fasteners made every day, BOSTITCH is one of the largest manufacturers of nailing & stapling tools and fasteners in the world.

We are dedicated to delivering the highest standards of products and support to the construction industry. To achieve this, we make sure that we listen to our customers' needs and design and manufacture the finest products for today's building materials and applications.

To make sure our tools match our reputation, we go to extremes to ensure that every tool bearing our name is more than capable of providing years of safe, reliable and trouble free service.

THE REASSURANCE OF GLOBAL LEADERSHIP

BOSTITCH is part of the **Stanley Black & Decker** organisation, the global leader in tool manufacture across a wide range of industries.

No company on earth has a stronger or more compelling history of delivering the hardworking, innovative and powerful tools that help professionals around the world keep working.

- \$11 billion value on worldwide markets
- Global recognition with an outstanding portfolio of global brands
- Recognised as among the top 10 global innovators
- No.1 for worldwide tool manufacture with outstanding quality control

To find out how your business can benefit from BOSTITCH expertise, call our sales team or visit the website:

AUSTRALIA

Tel: 1800 338 002

www.bostitchtools.com.au

NEW ZEALAND

Tel: 0800 4782 6539

www.bostitchtools.co.nz



Trade Range

4-23



FRAMING NAILERS

5-7

COIL NAILERS

8-11

**PINNERS, BRADDERS &
FINISH NAILERS**

12-16

CONSTRUCTION STAPLERS

17-21

MANUAL TACKERS

22-23

Industrial Range

24-33



**HEAVY DUTY FRAMING &
TRUSS TOOLS**

25

PACKAGING TOOLS

26-29

INDUSTRIAL STAPLERS

30-31

C-RING & SPENAX TOOLS

32-33

Office Products

34-35



TRADE RANGE

Rugged and powerful tools and fasteners for every job on site.

From framing and studwork to finish and trim, the **BOSTITCH** trade range of tools and fasteners is designed to deliver, whatever the task.

Our advanced tool designs are the result of dedicated research with feedback from real users, making them firm favourites with tradesmen. Innovative features like fastener lockouts and selectable triggers give versatility, increased productivity and a professional finish - every time.

The range includes specialist tools for flooring installations, detailed woodworking and high-volume joist hanger installations as well as a wide range of tools for general construction fixing such as:

● Framing ● Sub flooring ● Stud work ● Panelling ● Architraves ● Skirting ● Flooring ...and more

As well as a wide range of tools, the **BOSTITCH** fastener range includes a wide range of finishes and profiles giving you the ideal fastener for the job.

FRAMING NAILERS (pages 5-7)

Includes framing nailers for both Wire-Weld and Paper-Tape collated fasteners, a positive-placement nailer for joist hangers and the compact palm nailer.

COIL NAILERS (pages 8-11)

Ranges from the compact and lightweight N66C to the heavy duty N89C which can drive up to 90mm fasteners.

PINNERS, BRADDERS & FINISH NAILERS (pages 12-16)

Ideal for a wide range of second fix applications, from detailed trim and beading to door sets and panelling.

CONSTRUCTION STAPLERS (pages 17-21)

From the specialist MIIFS flooring tool to heavy duty S4 and S5 staplers, these staplers provide fast reliable stapling for construction.

MANUAL TACKERS (pages 22-23)









Includes manual squeeze and hammer tackers for rapid installation of waterproof membranes and sheet materials.



FRAMING NAILERS



FRAMING NAILER FEATURES

-  **28°** Fastener collation angle
-  **ST** Sequential trip trigger for safer operation
-  **360°** adjustable exhaust for comfort and safety
-  **Mg** Magnesium body for lighter weight
-  **HF** Steel frame protectors for added protection against damage
-  Exposed nail tip for easy nail placement and accurate fitting of joist hangers
-  Nail lockout to prevent dry firing
-  Compact magazine, for easy access between joists
-  Magnetic locating tip to hold the nail in position

WW 28° F28WW 28° FRAMING NAILER

This 28° stick nailer drives Wire-Weld nails up to 90mm. It includes a lightweight yet tough magnesium housing and steel frame protectors.

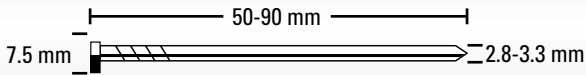

Tool Features



i For compatible fasteners, see page 7

PT 33° F33PT 33° FRAMING NAILER

Drives up to 90mm Paper-Tape nails with a lightweight magnesium body making it comfortable for use all day.

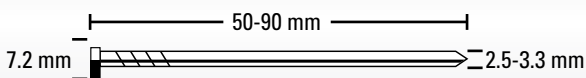

Tool Features



i For compatible fasteners, see page 7

FRAMING NAILERS

PT-MC

MCN150 CONNECTING NAILER

The award winning StrapShot™ MCN150 is the most advanced pneumatic positive placement nailer on the market. The compact StrapShot™ is designed to work where other nailers can't.

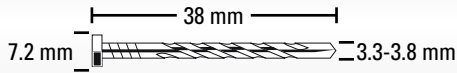

Tool Features



i For compatible fasteners, see page 7

BULK

PN50 PALM NAILER

Compact palm nailer designed for rapid driving of metal connecting nails and loose nails up to 8 mm head diameter.



Tool Features



i For compatible fasteners, see page 7



FRAMING NAILERS

FRAMING NAILERS FASTENER RANGE

SKU	FINISH	LENGTH (MM)	DIAMETER (MM)	PROFILE	QTY PER BOX
PT 28 28° PAPER-TAPE FRAMING NAILS					
S75P306P-3M	BRIGHT	75	3.06	SMOOTH	3000
WW 28 28° WIRE-WELD FRAMING NAILS					
S50P306	BRIGHT	50	3.06	SMOOTH	2000
S65P306	BRIGHT	65	3.06	SMOOTH	2000
S65R306	BRIGHT	65	3.06	RING	2000
S75P306-3M	BRIGHT	75	3.06	SMOOTH	3000
S75R306-3M	BRIGHT	75	3.06	RING	3000
S90P333	BRIGHT	90	3.33	SMOOTH	2000
S100P333	BRIGHT	100	3.33	SMOOTH	2000
S75P306-GAL-3M	GALV	75	3.06	SMOOTH	3000
S90P333-GAL	GALV	90	3.33	SMOOTH	2000
PT 33 33° PAPER-TAPE FRAMING NAILS					
SP75X306-3M	BRIGHT	75	3.06	SMOOTH	3000
SR75X306-3M	BRIGHT	75	3.06	RING	3000
SP90X333-3M	BRIGHT	90	3.33	SMOOTH	3000
SP50X287-3M-HDG	HDG	50	2.87	SMOOTH	3000
SP75X306-3MHDG	HDG	75	3.06	SMOOTH	3000
BRT 21 BRT FRAMING NAILS					
S38-130B	BRIGHT	130	3.8	SMOOTH	1250
PT-MC PAPER-TAPE METAL CONNECTING NAILS					
PT-MC13115G-1M	GALV	38	3.3	SMOOTH	1000
BULK BULK IMPACT / LOOSE NAILS					
BN45S287-15KG	BRIGHT	45	2.86	SCREW	6245
BN57S306-15KG	BRIGHT	57	3.06	SCREW	4360

COIL NAILERS



COIL NAILER FEATURES



Fastener collation angle



Steel frame protectors for added protection against damage



Contact trip trigger for rapid nailing



Rear exhaust directs air away from the operator



Dial-A-Depth for easy depth of drive adjustments



Protective guard prevents flying dust and debris



360° adjustable exhaust for comfort and safety



Twist adjust mechanism fast nail size changes



Impact resistant canister for added durability



Includes utility hook for convenient storage on site

N F N66C-1 COIL NAILER

The high capacity N66C-1 coil nailer has a tough, resilient housing that is made from light weight materials, ideal for prolonged use.

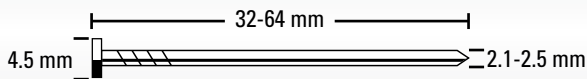

Tool Features



i For compatible fasteners, see page 11

N N70CB-1 COIL NAILER

The N70 was a firm favourite with pallet and fencing manufacturers due to its dependability and power. This new and improved version has been updated for even better performance.

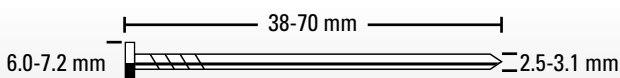

Tool Features



i For compatible fasteners, see page 11

N

F

N75C-1 COIL NAILER

Perfect for high-volume nailing of wall and roof sheathing, the N75C-1 coil nailer includes user friendly features designed to increase productivity and maximise comfort.

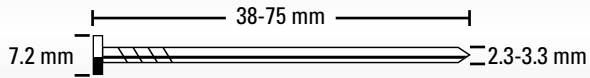

Tool Features



2.13 kg

i For compatible fasteners, see page 11

N

N80CB-1ML COIL NAILER

Designed for extended use in pallet manufacture, the N80CB drives a wide range of nail lengths reliably and consistently.

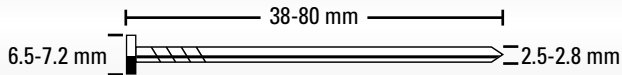

Tool Features



3.9 kg

i For compatible fasteners, see page 11



COIL NAILERS

N N89C-1 COIL NAILER

This tool offers a real alternative to heavier and larger tools. Despite its compact design, it can still drive up to 90mm length ring shank fasteners.

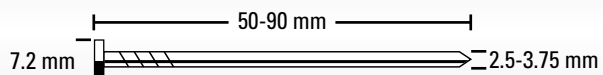

Tool Features



3.6 kg

i For compatible fasteners, see page 11

N N100C-1 COIL NAILER

The N100C offers the ultimate driving power and reliability and is ideally suited to demanding manufacturing lines where durability is paramount.

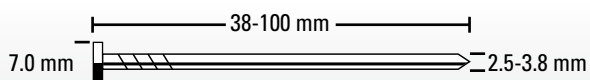

Tool Features



4.8 kg

i For compatible fasteners, see page 11



COIL NAILERS FASTENER RANGE

SKU	FINISH	LENGTH (MM)	DIAMETER (MM)	PROFILE	QTY PER BOX
N N SERIES WIRE-WELD COIL NAILS					
AC27R210	BRIGHT	27	2.1	RING	16800
AC32R210	BRIGHT	32	2.1	RING	16800
AC38R210	BRIGHT	38	2.1	RING	16800
AC38P210	BRIGHT	38	2.1	SMOOTH	16800
AC38R250	BRIGHT	38	2.5	RING	9900
AC45R210	BRIGHT	45	2.1	RING	16800
AC45P210	BRIGHT	45	2.1	SMOOTH	16800
AC45R250	BRIGHT	45	2.5	RING	6600
AC50R210	BRIGHT	50	2.1	RING	16800
AC50R250	BRIGHT	50	2.5	RING	6600
AC50S250	BRIGHT	50	2.5	SCREW	6600
AC50S250-LC7.5M	BRIGHT	50	2.5	SCREW	5000
AC50P250	BRIGHT	50	2.5	SMOOTH	6600
AC57R250	BRIGHT	57	2.5	RING	6600
AC57R287	BRIGHT	57	2.87	RING	6000
AC57S287	BRIGHT	57	2.87	SCREW	6000
AC57S287-6M	BRIGHT	57	2.87	SCREW	6000
AC57S287-LC7.5M	BRIGHT	57	2.87	SCREW	7500
AC64R250	BRIGHT	64	2.5	RING	6600
AC64R287	BRIGHT	64	2.87	RING	6000
AC64S287	BRIGHT	64	2.87	SCREW	6000
AC75S287	BRIGHT	75	2.87	SCREW	6000
AC75P287	BRIGHT	75	2.87	SMOOTH	6000
AC75R306	BRIGHT	75	3.06	RING	5400
AC75P306	BRIGHT	75	3.06	SMOOTH	5400
AC75P306-LC	BRIGHT	75	3.06	SMOOTH	6000
AC80P306	BRIGHT	80	3.06	SMOOTH	2700
AC83S306	BRIGHT	83	3.06	SCREW	2700
AC90P306	BRIGHT	90	3.06	SMOOTH	2700
AC90P333	BRIGHT	90	3.33	SMOOTH	2700
AC90P333-LC-3M	BRIGHT	90	3.33	SMOOTH	3000
AC100S333	BRIGHT	100	3.33	SCREW	2700
AC100P333	BRIGHT	100	3.33	SMOOTH	2700
AC100P333-LC	BRIGHT	100	3.33	SMOOTH	3000
AC25P180-GAL	GALV	24	1.8	SMOOTH	16200
C4DCSBALG	GALV	35	2.5	HELIX	3600
AC35R250-BD-GAL	GALV	35	2.5	RING	9900
AC35P250-GAL	GALV	35	2.5	SMOOTH	9000
AC45R250-GAL	GALV	45	2.5	RING	6600
AC45P250-GAL	GALV	45	2.5	SMOOTH	6600
AC50R250-GAL	GALV	50	2.5	RING	6600
AC50P250-GAL	GALV	50	2.5	SMOOTH	6600
AC64R287-GAL	GALV	64	2.87	RING	6000
AC64S287-GAL	GALV	64	2.87	SCREW	6000
F F SERIES PLASTIC COLLATED COIL NAILS					
FAP27V5	GALV	27	2.5	SCREW	6000
FAP32V5	GALV	32	2.5	SCREW	6000
FAP32V9	GALV	32	2.9	FLUTED	6000
FAP38V5	GALV	38	2.5	SCREW	6000
ACDH50R250-GAL	GALV	50	2.5	RING	1600
ACDH50S250-GAL	GALV	50	2.5	SCREW	1600
ACDH65R270-GAL	GALV	65	2.7	RING	1600
ACDH65S270-GAL	GALV	65	2.7	SCREW	1600
ACDH50R250-SS	STAINLESS	50	2.5	RING	1600
ACDH50S250-SS	STAINLESS	50	2.5	SCREW	1600
ACDH65R270-SS	STAINLESS	65	2.7	RING	1600
ACDH65S270-SS	STAINLESS	65	2.7	SCREW	1600

PINNERS, BRADDERS & FINISH NAILERS



PINNERS, BRADDERS & FINISH NAILERS FEATURES



Fastener collation angle



Variable power control for precise adjustments in the depth of drive



SmartPoint™ for improved visibility and no marring



Rear exhaust directs air away from work area and the user



Secondary safety trigger allows staples to be driven without touching the wood



Oil free engine ensures low maintenance and eliminates oil stains on the workpiece



Selectable trigger system switches between sequential and contact trip



Dial-A-Depth for adjusting the depth of drive quickly and easily



Sequential trip trigger for safer operation



Integrated air blower allows users to quickly and easily clear away debris

HP

HP118K 23GA PINNER

The HP118K is a lightweight small gauge pinner and is perfect for fine mouldings (avoiding marking of the job), beading or even for tacking work in place while the glue dries.

12-25 mm
23 Gauge

0.98 kg



Tool Features



i For compatible fasteners, see page 16



PINNERS, BRADDERS & FINISH NAILERS

C-1

BT1855K 18GA BRADDER

The BT1855 tool is the most feature-packed brad nailer on the market and comes complete with a host of innovations to meet the demands of today's construction users.

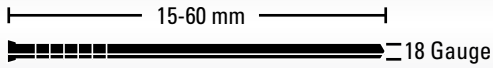

Tool Features



i For compatible fasteners, see page 16

C-1

BT1855SP-A 18GA SMARTPOINT™ BRADDER*

This **SmartPoint™** tool is the most feature-packed brad nailer on the market and comes complete with a host of innovations to meet the demands of today's construction users.

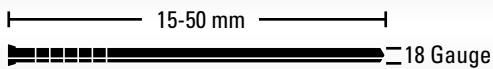

Tool Features



*Available late 2016

i For compatible fasteners, see page 16



PINNERS, BRADDERS & FINISH NAILERS

C

FN1664K 16GA FINISH NAILER

1.7 kg

The FN1664K has a lightweight magnesium body, no-nail lockout, rear exhaust and selectable trigger and comes complete with 1000 fasteners and heavy duty carry case.

32-64 mm
16 Gauge

Tool Features



i For compatible fasteners, see page 16

C

FN1664SP-A 16GA SMARTPOINT™ FINISH NAILER*

1.8 kg

The FN1664SP-A finish nailer is not only oil-free, minimising maintenance, but is also fitted with the innovative SmartPoint™ system for improved access and easier working.

25-64 mm
16 Gauge

Tool Features



*Available late 2016

i For compatible fasteners, see page 16



PINNERS, BRADDERS & FINISH NAILERS

AS-DA

DA1564K 15GA FINISH NAILER

1.8 kg

The compact design and angled magazine of the DA1564K finishing nailer gives you easy access to even the smallest corners, making it the perfect tool for finishing almost all construction applications.

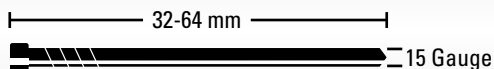

Tool Features



i For compatible fasteners, see page 16

AS-DA

DA1564SP-A 15GA SMARTPOINT™ FINISH NAILER*

2.1 kg

The **SmartPoint™** nose and angled magazine of the DA1564SP-A nailer gives you easy access to even the smallest corners, making it the perfect tool for finishing almost all construction applications.

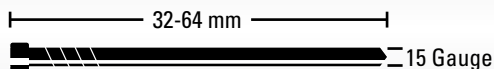

Tool Features



*Available late 2016

i For compatible fasteners, see page 16

FN15

N62FNK-2 15GA FINISH NAILER

1.8 kg

The N62FNK-2 is incredibly light weight yet it can be used with the hardest of woods. The oil-free tool design requires only minimal maintenance.

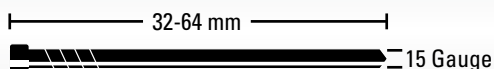

Tool Features



i For compatible fasteners, see page 16

PINNERS, BRADDERS & FINISH NAILERS

SECOND FIX NAILING FASTENER RANGE

SKU	FINISH	LENGTH (MM)	GAUGE	DIAMETER (MM)	PROFILE	QTY PER BOX
HP HP SERIES HEADLESS PINS						
PT-2312-3M	BRIGHT	12	23 GAUGE	0.64	SMOOTH	3000
PT-2319-3M	BRIGHT	19	23 GAUGE	0.64	SMOOTH	3000
PT-2325-3M	BRIGHT	25	23 GAUGE	0.64	SMOOTH	3000
C-1 C-1 SERIES BRAD NAILS						
C-115	BRIGHT	15	18 GAUGE	1.3	SMOOTH	5000
C-120	BRIGHT	20	18 GAUGE	1.3	SMOOTH	5000
C-125	BRIGHT	25	18 GAUGE	1.3	SMOOTH	5000
C-130	BRIGHT	30	18 GAUGE	1.3	SMOOTH	5000
BT1335B	BRIGHT	34	18 GAUGE	1.3	SMOOTH	3000
BT1340B	BRIGHT	39	18 GAUGE	1.3	SMOOTH	2000
BT1350B	BRIGHT	50	18 GAUGE	1.3	SMOOTH	2000
C C SERIES STRAIGHT FINISH NAILS						
C25	BRIGHT	25	16 GAUGE	1.54	SMOOTH	2500
C32	BRIGHT	32	16 GAUGE	1.54	SMOOTH	2500
C38	BRIGHT	38	16 GAUGE	1.54	SMOOTH	2500
C45	BRIGHT	45	16 GAUGE	1.54	SMOOTH	2500
C50	BRIGHT	50	16 GAUGE	1.54	SMOOTH	2500
C64-S	BRIGHT	64	16 GAUGE	1.54	SMOOTH	2500
AS-DA AS-DA SERIES 35° ANGLED FINISH NAILS						
AS-DA15-GAL	GALV	32	15 GAUGE	1.76	SMOOTH	3000
AS-DA17	BRIGHT	38	15 GAUGE	1.76	SMOOTH	3000
AS-DA19	BRIGHT	45	15 GAUGE	1.76	SMOOTH	3000
AS-DA21	BRIGHT	50	15 GAUGE	1.76	SMOOTH	3000
AS-DA23	BRIGHT	57	15 GAUGE	1.76	SMOOTH	3000
AS-DA25	BRIGHT	63	15 GAUGE	1.76	SMOOTH	3000
FN15 FN15 SERIES 25° ANGLED FINISH NAILS						
FN1520	BRIGHT	32	15 GAUGE	1.82	SMOOTH	3655
FN1524	BRIGHT	38	15 GAUGE	1.82	SMOOTH	3655
FN1528	BRIGHT	44	15 GAUGE	1.82	SMOOTH	3655
FN1532	BRIGHT	50	15 GAUGE	1.82	SMOOTH	3655
FN1540	BRIGHT	64	15 GAUGE	1.82	SMOOTH	3655
FN16 FN16 SERIES 25° ANGLED FINISH NAILS						
FN1620	GALV	31	16 GAUGE	1.53	SMOOTH	5000
FN1624	GALV	38	16 GAUGE	1.53	SMOOTH	5000
FN1628	GALV	44	16 GAUGE	1.53	SMOOTH	5000
FN1632	GALV	50	16 GAUGE	1.53	SMOOTH	5000
T T SERIES FINISH NAILS						
BFG22/38	GALV	38	14 GAUGE	2.2	SMOOTH	1000
BFG22/45	GALV	45	14 GAUGE	2.2	SMOOTH	1000
BFG22/50	GALV	50	14 GAUGE	2.2	SMOOTH	1000
BFG25/50	GALV	50	13 GAUGE	2.5	SMOOTH	1000
BFG25/65	GALV	65	13 GAUGE	2.5	SMOOTH	1000

CONSTRUCTION STAPLERS



CONSTRUCTION STAPLER FEATURES



Secondary safety trigger allows staples to be driven without touching the wood



Anti slip bumpers- helps prevent damage



Contact trip trigger for rapid nailing



Fastener lockout system prevents dry firing & reworking



Selectable trigger system switches between sequential and contact trip



Oil free engine ensures low maintenance and eliminates oil stains on the workpiece



Variable power control for precise adjustments in the depth of drive



Dial-A-Depth for adjusting the depth of drive quickly and easily



Rear exhaust directs air away from work area and the user



Anti-jam magazine- for faster throughput



Lightweight yet strong aluminium housing



Button cap tool for fastening sheet materials

BCS15

MIIFS FLOORING STAPLER

Built to drive staples accurately and quickly, this pneumatic flooring stapler is perfect for laying large areas of flooring. It features a contoured foot to fit snugly on to the boards, positioning the tool for an extremely accurate and neat result.

BCS-15 Series

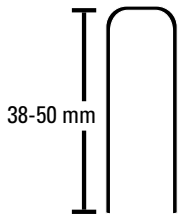

Tool Features



i For compatible fasteners, see page 21



HFM-3 Mallet



Includes a soft replaceable face to protect flooring and tool and a jacketed graphite handle adds strength and durability while providing the feel of wood.



CONSTRUCTION STAPLERS

71 21671B WIDE CROWN STAPLER

Lightweight, compact tool with robust build quality for rapid wide-crown stapling. Includes power adjustment for precision fastening.

0.8 kg

71 Series

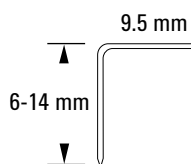

Tool Features



i For compatible fasteners, see page 21

80 21680B WIDE CROWN STAPLER

Lightweight, compact tool with robust build quality for rapid wide-crown stapling. Includes power adjustment for precision fastening.

0.8 kg

80 Series

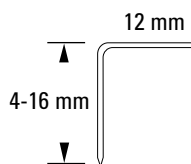

Tool Features



i For compatible fasteners, see page 21



CONSTRUCTION STAPLERS

SX

SX1838K CONSTRUCTION STAPLER

1.36 kg

With user-friendly features such as Dial-A-Depth for quick countersinking adjustments and a selectable trigger system, the SX1838 stapler will make light work of construction applications.

SX Series

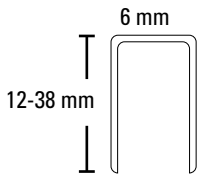

Tool Features



i For compatible fasteners, see page 21

SL

SL1838BC BUTTON CAP STAPLER

1.8 kg

Button cap tools are the perfect solution for fastening flexible linings. The caps spread the load preventing pull through and ensuring a strong fixing.

SL Series

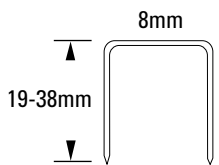

Tool Features

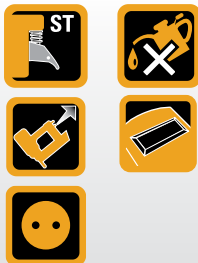

i For compatible fasteners, see page 21



CONSTRUCTION STAPLERS

S5 538S5-1 HEAVY DUTY S5 STAPLER

1.8 kg

Features an adjustable power control for variable fastener penetration and a rear exhaust for user comfort.

S5 Series

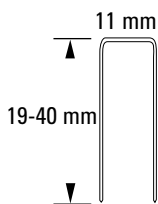

Tool Features

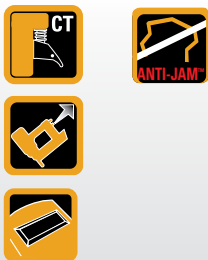

i For compatible fasteners, see page 21

S4 650S4-1 HEAVY DUTY S4 STAPLER

2 kg

Features Dial-a-Depth power control for variable fastener penetration and 360° exhaust for a cleaner working environment. Two models available for S4 and S5 staples.

S4 Series

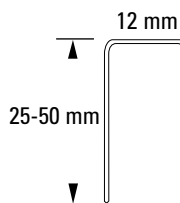

Tool Features

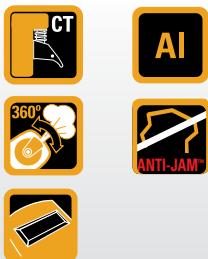

i For compatible fasteners, see page 21

S5 650S5-1 HEAVY DUTY S5 STAPLER

2 kg

Features Dial-a-Depth power control for variable fastener penetration and 360° exhaust for a cleaner working environment. Two models available for S4 and S5 staples.

S5 Series

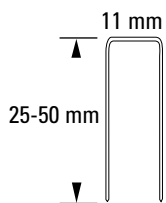

Tool Features

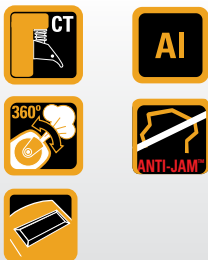

i For compatible fasteners, see page 21

CONSTRUCTION STAPLERS

STAPLING FASTENER RANGE

SKU	FINISH	LENGTH (MM)	CROWN WIDTH (MM)	PROFILE	QTY PER BOX
BCS15 BCS15 SERIES FLOORING STAPLES					
BCS1512-1M	GALV	38	12.5	SMOOTH	1000
BCS1514-1M	GALV	45	12.5	SMOOTH	1000
BCS1514-5M	GALV	45	12.5	SMOOTH	5014
BCS31 BCS31 SERIES FOR BCAR COIL SPRING					
BCS31-5M	GALV	19	10	SMOOTH	5000
BCS31P-TAPE	BRIGHT	19	10	SMOOTH	29184
BCS32 BCS32 SERIES STAPLES					
BCS32-5M	GALV	22	6	SMOOTH	5000
SX SX SERIES STAPLES					
SX5035-12MM	GALV	12	6	SMOOTH	5000
SX5035-16MM	GALV	16	6	SMOOTH	5000
SX5035-18MM5M	GALV	18	6	SMOOTH	5000
SX5035-22MM	GALV	22	6	SMOOTH	5000
SX5035-25MM	GALV	25	6	SMOOTH	5000
SX5035-30MM5M	GALV	30	6	SMOOTH	5000
SX5035-32MM5M	GALV	32	6	SMOOTH	5000
SX5035-35MM5M	GALV	35	6	SMOOTH	5000
SL SL STAPLES MEDIUM DUTY STAPLES					
SL50353/4G	GALV	19	8	SMOOTH	5000
SL50351G	GALV	25	8	SMOOTH	5000
SL50351-1/8G	GALV	28	8	SMOOTH	3000
SL503535Z	GALV	35	8	SMOOTH	5000
SB CAPS CAPS & COMBO PACKS					
SB-CAPS	-	-	-	-	10000 (Caps Only)
CAPPAK-5M	GALV	25	8	SMOOTH	5000 (Caps & Staples)
71 71 SERIES STAPLES					
71/08-10M	BRIGHT	8	9.5	SMOOTH	10000
71/10-10M	BRIGHT	10	9.5	SMOOTH	10000
71/12-10M	BRIGHT	12	9.5	SMOOTH	10000
80 80 SERIES STAPLES					
80/6	GALV	6	12	SMOOTH	10000
80/8	GALV	8	12	SMOOTH	10000
80/10	GALV	10	12	SMOOTH	10000
80/12	GALV	12	12	SMOOTH	10000
80/14	GALV	14	12	SMOOTH	10000
80/6SS-10M	STAINLESS	6	12	SMOOTH	10000
80/10SS-10M	STAINLESS	10	12	SMOOTH	10000
S4 S4 SERIES					
BCS4-1219	GALV	19	12	SMOOTH	12320
BCS4-1225	GALV	25	12	SMOOTH	9520
BCS4-1232	GALV	32	12	SMOOTH	7140
BCS4-1238	GALV	38	12	SMOOTH	6720
BCS4-1245	GALV	45	12	SMOOTH	5320
BCS4-1250	GALV	50	12	SMOOTH	5040
S5 S5 SERIES STAPLES					
BCS5-1132	GALV	32	11	SMOOTH	8400
BCS5-1138	GALV	38	11	SMOOTH	6860
BCS5-1145	GALV	45	11	SMOOTH	5880

MANUAL TACKERS

SP19 P3-CHROME TACKER

Lightweight, versatile plier for use with the SP1906 staple range, available in chrome. Perfect for light duty office use and packing applications such as for florists.

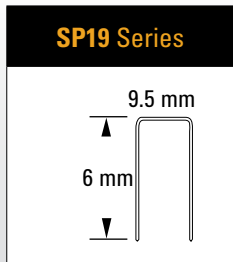

i For compatible fasteners, see page 23

STCR 5019 T6-8 TACKER

The T6-8 series is precision engineered with an easy-grip handle, steel nose plate and rugged construction to make this tool powerful yet simple to use.

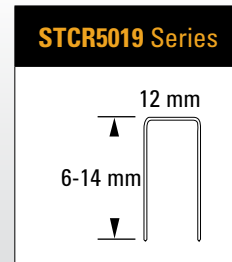

i For compatible fasteners, see page 23

STCR 5019 H30-8 HAMMER TACKER

The H30-8 includes a die cast frame and hardened steel components for extreme durability. Ideal for despatch labels and general tacking.

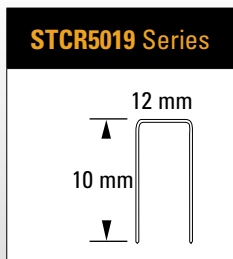

i For compatible fasteners, see page 23

STCR 5019 PC2K HAMMER TACKER

Perfectly balanced with an ergonomic design, the PC2K makes light work of slam tacking jobs. Ideal for case lining and insulation.

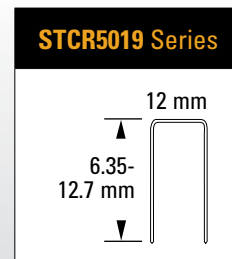

i For compatible fasteners, see page 23





P6C-8 / P6C-8P TACKERS

Lightweight squeeze tacker ideal for small carton lids, polythene bag sealing, card topped bags, card/padded envelopes and general stapling. P6C-8P includes pointed tip for penetrating box sides.



P6C-8P

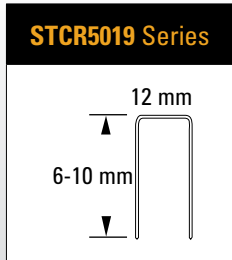

i For compatible fasteners, see below

MANUAL TACKERS FASTENER RANGE

SKU	FINISH	LENGTH (MM)	CROWN WIDTH (MM)	PROFILE	QTY PER BOX
STCR5019 SERIES POWERCROWN STAPLES					
STCR50191/4-1M	BRIGHT	6	12	SMOOTH	1000
STCR50191/4-6M	BRIGHT	6	12	SMOOTH	6000
STCR50193/8-1M	BRIGHT	9	12	SMOOTH	1000
STCR50193/8-5M	BRIGHT	9	12	SMOOTH	5000
STCR50191/2-1M	BRIGHT	12	12	SMOOTH	1000
STCR50191/2-4M	BRIGHT	12	12	SMOOTH	4032
STCR50199/16-1	BRIGHT	14	12	SMOOTH	1000
STCR50199/16-4	BRIGHT	14	12	SMOOTH	4032
SP19 SERIES STAPLES					
SP191/4	BRIGHT	6	9.5	SMOOTH	5000

HIGH POWER STAPLING.

The unique shape of Bostitch PowerCrown staples gives you more penetration with less effort.

Available in a wide range of lengths they are ideally suited to fastening paper, card and light plastics such as end caps, carded and uncarded bag tops, trays and small boxes.

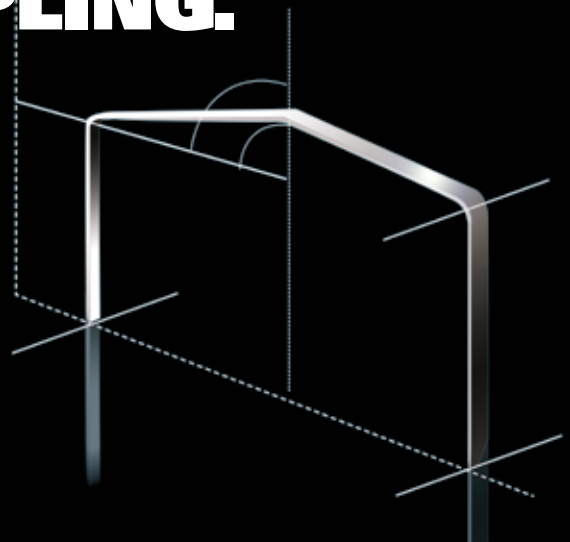

INDUSTRIAL RANGE

Industrial fastening experience that's second to none...

This range of professional fixings solutions reflects our continued innovation and dedication to product development across a variety of industrial sectors.

Efficient working with minimal downtime is the goal for any business, so to make sure our tools match our reputation, we go to extremes to ensure that every tool bearing our name is more than capable of providing years of safe, reliable and trouble free service.

HEAVY DUTY FRAMING & TRUSS TOOLS (page 25)

Includes a heavy duty coil nailer and corrugated fastener tool for industrial framing manufacturing and corner jointing.

PACKAGING TOOLS (pages 26-29)

Top and bottom sealing tools are designed to offer dependable performance in light, medium or high volume packaging environments.

The range also includes tools and fasteners for both general and specialised packaging applications, including sealing header cards, postal tubes, bags and wrapping.

INDUSTRIAL STAPLERS (pages 30-31)

Our tool and fastener range covers all types of frame manufacture for furniture and construction. The heavy duty staples maintain the shape and structure of materials by reducing twisting and deforming compared to using nails.

C-RING & SPENAX TOOLS (pages 32-33)

The **BOSTITCH** range of ringers and fasteners provides rings suitable for budget construction through to pocket sprung and flat border wire fastening.



HEAVY DUTY FRAMING & TRUSS TOOLS

N F N100C-1 COIL NAILER

The N100C offers the ultimate driving power and reliability and is ideally suited to demanding manufacturing lines where durability is paramount.



Tool Features



i For compatible fasteners, see page 11

CF CF15-2 CORRUGATED STAPLER

Lateral grip from the corrugated fastener is ideal for the bracing of frame joints or mitres. The fastener can be used to repair or reinforce splits along the grain.

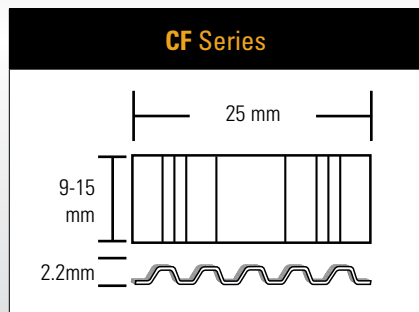

Tool Features



i For compatible fasteners, see below

CORRUGATED FASTENER RANGE

SKU	FINISH	LENGTH (MM)	DIAMETER (MM)	PROFILE	QTY PER BOX
CF CF SERIES					
CF375-2000	BRIGHT	10	2.5	SMOOTH	2000
CF500-1750	BRIGHT	12	2.5	SMOOTH	1750



PACKAGING TOOLS



PACKAGING TOOL FEATURES



Pneumatic tool reduces fatigue in busy packing environments



Includes hand pad for comfortable operation



Manual tool - no air supply required



150mm jaw depth for easy stapling away from the edge



Mounting lug for wire support, reducing user fatigue



Uses PowerCrown staples for greater power



Mounting lug for wire support, reducing user fatigue

PACKAGING TOOL SELECTOR

APPLICATION		TOP SEALING		BOTTOM SEALING	GENERAL PACKAGING		
STAPLE TYPE		ROLL	STICK	STICK	STICK	STICK	STICK
MODEL		D62ADC	DS-3522	F84-138	P51-10B	P51-5B	JB600
Staple Family							
Crown Width		35mm	35mm	35mm	12.7mm	12.7mm	12.7mm
Board Type / Staple Length	Single Wall	16-19mm	15-19mm	15-19mm	6-16mm	6-16mm	6-10mm
	Double Wall	19mm	19mm	19mm	16mm	16mm	10mm



SWC D62ADC CARTON CLOSER

The D62ADC is a pneumatic top sealer built for larger volumes and heavy applications where a wider wire gauge is needed, these tools are the largest 'roll' tools in the range.

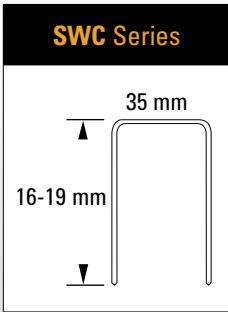

Tool Features



i For compatible fasteners, see page 29

SW7437 DS-3522 CARTON CLOSER

The DS-3522 is a pneumatic top sealer built for larger volumes and is ideal for despatch lines, providing a consistent clinch with minimal effort.

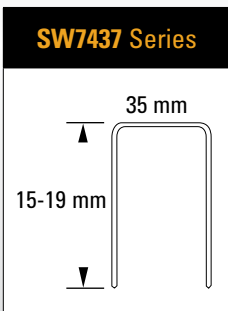

Tool Features



i For compatible fasteners, see page 29

SW7437 F84-138 BOTTOM SEALER

Designed for stapling the bottom of cartons by using a fixed anvil post, these foot-operated tools are a vital part of a productive packing line.

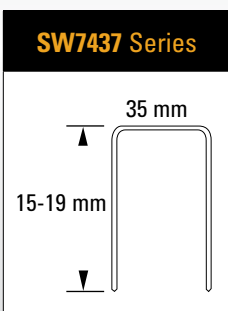

Tool Features



i For compatible fasteners, see page 29

PACKAGING TOOLS

SB103020

P51-10B PLIER

SB5019

P51-5B PLIER

2 kg

The versatile P51 Series pliers are compact and lightweight pneumatic pliers with a deep jaw depth of 150mm. They can be used across a wide variety of applications, from carton lids to storage tubes.

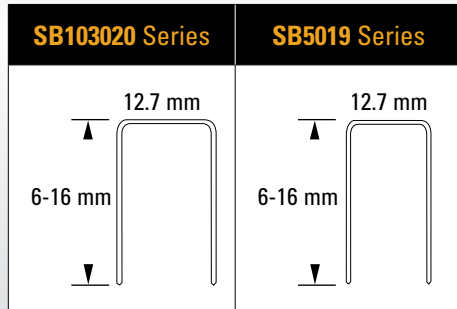

Tool Features



i For compatible fasteners, see page 29

STCR 5019

JB600 PLIER

1 kg

Pneumatic squeeze tacker designed for repetitive fastening. Ideal for tube and pack endcaps, small carton lids, polythene bag sealing, and card topped bags.

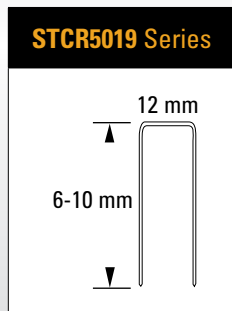

Tool Features



i For compatible fasteners, see page 23



PACKAGING FASTENER RANGE

SKU	FINISH	LENGTH (MM)	CROWN WIDTH (MM)	PROFILE	QTY PER BOX
SWC SWC SERIES CARTON STAPLES					
SW1C-16MM	BRIGHT	16	35	SMOOTH	24000
SW1C-18MM	BRIGHT	18	35	SMOOTH	24000
SW4C-19MM	BRIGHT	19	35	SMOOTH	24000
SB103020 SB103020 SERIES CARTON STAPLES					
SB1030203/82.9	BRIGHT	9	12.7	SMOOTH	2900
SB1030201/22M	BRIGHT	13	12.7	SMOOTH	2100
SB1030205/82.5	BRIGHT	15	12.7	SMOOTH	2490
SB5019 SB5019 SERIES CARTON STAPLES					
SB50193/8-8M	GALV	10	12.7	SMOOTH	8000
SB50191/2-6M	GALV	13	12.7	SMOOTH	6000
SW7437 SW7437 SERIES CARTON STAPLES					
SW74375/8	BRIGHT	15	35	SMOOTH	2400
SW74373/4	BRIGHT	19	35	SMOOTH	2400
SW9040 SW9040 SERIES CARTON STAPLES					
SW90405/8	BRIGHT	15	35	SMOOTH	2000
SW90407/8	BRIGHT	22	35	SMOOTH	2000



INDUSTRIAL STAPLERS



INDUSTRIAL STAPLER FEATURES



Contact trip trigger for rapid stapling



Adjustable power control ensures controlled fastener penetration



Rear exhaust directs air away from the operator



Anti-jam magazine for minimal downtime



Anti slip bumpers prevent damage



360° adjustable exhaust for comfort and safety



Mounting lug- for wire support, reducing user fatigue



Aluminium housing for durability and light weight

SL

S32SL-1 STAPLER

1.1 kg

The S32SL-1 features a compact, well-balanced and lightweight design and is also extremely durable, ensuring a long service life even in the toughest of work environments.

SL Series

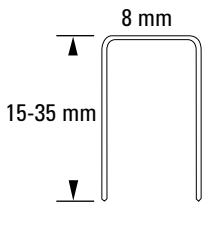

Tool Features

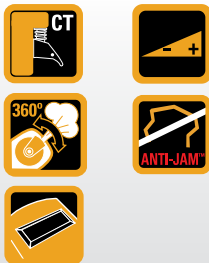

i For compatible fasteners, see page 31

S2

438S2R-1 STAPLER

S4

438S4-1 STAPLER

1.8 kg

The 438 series includes models to drive either S2 or S4 staples depending on the required crown width needed for the application.

S2 Series

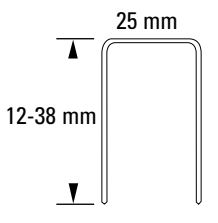

S4 Series

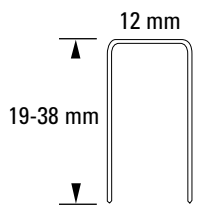

Tool Features

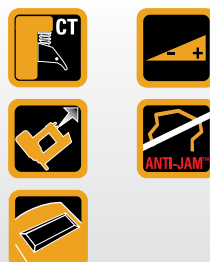

i For compatible fasteners, see page 31

INDUSTRIAL STAPLERS

S4

750S4-1 STAPLER

S5

750S5-1 STAPLER

2.4 kg

With a compact nose and Dial-a-Depth adjustment, this tool is ideally suited to heavy duty framing applications. Two models available for S5 and S4 staples.

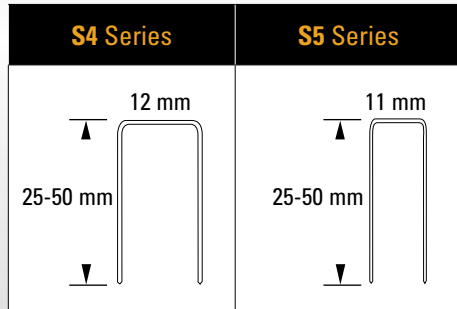

Tool Features

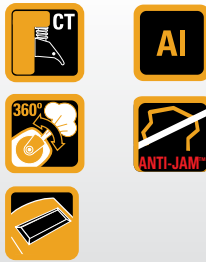

i For compatible fasteners, see below

STAPLING FASTENER RANGE

SKU	FINISH	LENGTH (MM)	CROWN WIDTH (MM)	PROFILE	QTY PER BOX
S4 SL STAPLES MEDIUM DUTY STAPLES					
SL50353/4G	GALV	19	8	SMOOTH	5000
SL50351G	GALV	25	8	SMOOTH	5000
SL50351-1/8G	GALV	28	8	SMOOTH	3000
SL503535Z	GALV	35	8	SMOOTH	5000
S5 S5 SERIES HEAVY DUTY STAPLES					
BCS5-1132	GALV	32	11	SMOOTH	8400
BCS5-1138	GALV	38	11	SMOOTH	6860
BCS5-1145	GALV	45	11	SMOOTH	5880
S4 S4 SERIES HEAVY DUTY STAPLES					
BCS4-1219	GALV	19	12	SMOOTH	12320
BCS4-1225	GALV	25	12	SMOOTH	9520
BCS4-1232	GALV	32	12	SMOOTH	7140
BCS4-1238	GALV	38	12	SMOOTH	6720
BCS4-1245	GALV	45	12	SMOOTH	5320
BCS4-1250	GALV	50	12	SMOOTH	5040
S2 S2 SERIES HEAVY DUTY STAPLES					
BCS2-2516-7M	GALV	16	25	SMOOTH	6720
BCS2-2519	GALV	19	25	SMOOTH	6160
BCS2-2525	GALV	25	25	SMOOTH	4480
BCS2-2532-3M	GALV	32	25	SMOOTH	3360
BCS2-2538	GALV	38	25	SMOOTH	3080

C-RING & SPENAX TOOLS

The range includes two ring types and which one to use will depend on the application:





- **C Rings** - these close evenly and tightly around the product making a secure closure that tends to size itself to the application. Typically, C Rings are used in automotive seating, bagging and wire fencing.
- **D rings** - these have sharper angles and, when closed, form a triangle that tends to fit more loosely around the application. They are ideally suited to bedding and upholstery applications.

To select the right tool for your application:

1. Measure the total distance across the wires when put together making an allowance for either a 'tight' or 'loose' finished clinch.
2. Find the ring with a minimum or maximum closure closest to your need using the table opposite.



TOOL TO RING SIZE GUIDE

TOOL	P7	SC761	SC760	SC742	SC7E	SC7C	SC50T	TR203
Tool Weight 	0.35kg	2.9kg	2.9kg	3.2kg	2.9kg	2.9kg	6.5kg	1.6kg
Ring Open Size 	17 mm	12.5mm	12.5mm	19mm	19mm	19mm	38mm	19mm
Ring Closure Size Min. 	11.1 mm	5.6mm	5.6mm	8.7mm	10.7mm	8.7mm	23.5mm	9.5mm
Ring Closure Size Max. 	7 mm	4.8mm	3.2mm	4.8mm	7.9mm	4.8mm	14.3mm	6.3mm
Rings Part No.	RING 616	RING 516 *	RING 16 *	RING 15	RING 11	RING SR15		

C-RING & SPENAX TOOLS

P7 MANUAL C-RINGER



These manual tools are quick and easy to use and are ideal for quick repairs and installations off-site.



SC SERIES C-RINGERS



Aluminium bodied C ringer with a air return mechanism.



TR SERIES D-RINGERS

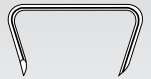

Aluminium bodied D ringer with a spring return mechanism.

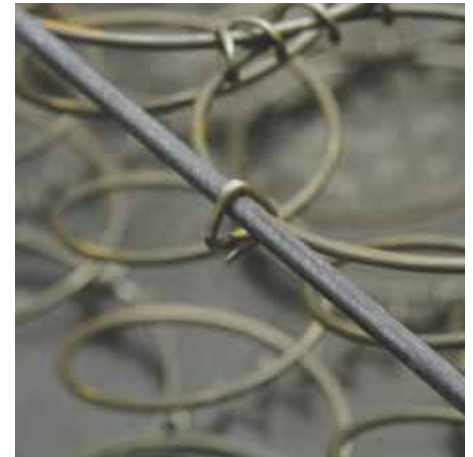

C & D RING FASTENER RANGE

SKU	FINISH	RING SIZE (MM)	DIAMETER (MM)	PROFILE	QTY PER BOX
RING 11 RING 11 SERIES C RINGS					
RING11AL40	ALU	14-38	2.3 (11GA)	SMOOTH	38
RING11RG40	GALV	14-38	2.3 (11GA)	SMOOTH	38
RING11SS40	STAINLESS	14-38	2.3 (11GA)	SMOOTH	38
RING11GLF40	GALV	14-38	2.3 (11GA)	SMOOTH	38
RING 15 RING 15 SERIES C RINGS					
RING15G100P	GALV	5-19	1.8 (15GA)	SMOOTH	2000
RING15SS100B	STAINLESS	5-19	1.8 (15GA)	SMOOTH	2000
RING 616 RING 616 SERIES C RINGS					
RING616G50	GALV	7-17	1.6 (16GA)	SMOOTH	1300
RING SR15 RING SR15 SERIES D RINGS					
RINGSR15	BRIGHT	6-19	1.8 (15GA)	SMOOTH	1300

*For details of RING 516 and RING 16 fasteners please contact customer services.

OFFICE PRODUCTS

BOSTITCH has been at the forefront of fastening since 1914, when the first desk stapler was introduced and since the development of the classic **B8**, the **BOSTITCH** range has increased to satisfy the ever changing demands of office products.

Choose from desk staplers using standard 26/6 staples to heavy duty staplers such as the B310HDS that can staple up to 130 sheets at once.



STCR 2115 **B8R-BLACK STAPLER**

The B8 has been the office workhorse for many years and includes a steel base and reversible staple remover.



i For compatible fasteners, see page 35

26/6 **B440LR STAPLER**

Includes a long reach neck document guide for accurately stapling documents and booklets.



i For compatible fasteners, see page 35

26/6 **B440-BLACK STAPLER**

The B440 features all metal construction and a dual clinch system for permanent or temporary stapling.



i For compatible fasteners, see page 35

26/6 **B660-BLACK STAPLER**

The B660 office stapler allows for both conventional or outward clinch and can staple up to 30 sheets at once.



i For compatible fasteners, see page 35

26/6 **626-BLK-PP STAPLING KIT**

This desktop stapler kit includes a stapler, a pinch style staple remover, and 5,000 standard staples.

The stapler can easily staple up to 20 sheets and opens flat for bulletin board tacking or craft use.



i For compatible fasteners, see page 35

SB35 **B310HDS STAPLER**

A durable heavy-duty stapler able to staple up to 130 sheets at a time with innovative No-Jam™ technology to eliminate frustrating staple jams.

Includes an adjustable staple guide for consistent, accurate staple placement.



i For compatible fasteners, see page 35

**STCR
2115**

0-2245 PLIER

Perfect for everyday tasks, the handy plier format is easy to use and reload.



i For compatible fasteners, see below

T10

T10CS TACKER

Multi purpose tacker, ideal for posters and noticeboards.



i For compatible fasteners, see below

G27W STAPLE REMOVER

Nickel-plated heavy duty staple remover for carton staples and thick stacks of paper.



G2K STAPLE REMOVER

Office staple remover with integrated magnet for a clean operation.



OFFICE PRODUCTS FASTENER RANGE

SKU	FINISH	LENGTH (MM)	PROFILE	QTY PER BOX
26/6 26/6 SERIES STAPLES				
26/6	BRIGHT	6	SMOOTH	5000
SB35 SB35 SERIES STAPLES				
SB351/4-1M	BRIGHT	6	SMOOTH	1000
SB353/8-1M	BRIGHT	10	SMOOTH	1000
SB351/2-1M	BRIGHT	13	SMOOTH	1000
SB355/8-1M	BRIGHT	16	SMOOTH	1000
SCCR25 SCCR25 SERIES STAPLES				
SCCR25-10MM	BRIGHT	10	SMOOTH	5000
SCCR253/8	GALV	10	SMOOTH	5000
STCR2115 STCR2115 SERIES STAPLES				
STCRP21151/4	BRIGHT	6	SMOOTH	5000
STCR21153/8	BRIGHT	10	SMOOTH	5000
T10 T10 SERIES STAPLES				
SP6DK	BRIGHT	6	SMOOTH	1000
SP8DK	BRIGHT	8	SMOOTH	1000
SP10DK	BRIGHT	10	SMOOTH	1000

BOSTITCH ONLINE

Visit the website to find out more about the BOSTITCH range of construction, industrial and office products as well as comprehensive technical specifications and the full range of tools and fasteners.



WHERE TO BUY

Find your nearest
BOSTITCH dealer

COMPARATORS

Choose the ideal tool
for the job

LATEST

Find news and
events in your area

DOWNLOADS

Tool documents
and literature

To find out more visit www.bostitchtools.com.au or www.bostitchtools.co.nz

TOOLS | FASTENERS | SPECIFICATIONS | LOCAL DEALERS AND MORE

Authorised distributor

AU

Bostitch Australia
810 Whitehorse Road,
Box Hill,
Victoria, 3128
Australia

Tel: 1800 338 002

www.bostitchtools.com.au

NZ

Bostitch New Zealand
39 Business Parade North,
Highbrook, 2013,
Auckland
New Zealand

Tel: 0800 4782 6539

www.bostitchtools.co.nz

All tool data shown is for comparative purposes only. Full Health & Safety technical data is available on request. Features and specifications subject to modification without notice.