

BOSHART INDUSTRIES

Telephone: 1-519-595-4444 - Toll Free: 1-800-561-3164

Fax: 1-519-595-4380 - www.boshart.com

SECTION 11 PITLESS ADAPTERS, WELL CAPS & WELL SEALS

PRODUCT LINE	PAGE
Pitless Adapters	1
Stainless Steel Pitless Adapters	1
Industrial Pitless	5
Well Caps	7
Well Seals	12
Gromet Kits	14
PVC Well Seal Air Vent	14
Zinc Plated Steel Air Vent	14

BOSHART INDUSTRIES

Telephone: 1-519-595-4444 - Toll Free: 1-800-561-3164

Fax: 1-519-595-4380 - www.boshart.com

11-1
April 27/20

NO LEAD BRONZE PITLESS ADAPTERS

PART NO.	MAKE	SIZE	DROP PIPE SIZE	CASING SIZE	HOLE SAW SIZE	WORKING LOAD-lbs	SHIPPING WGT-lbs	QUANTITY CTN	LIST PRICE-A
PA-800NL	BII	1"	1"	5" - 12"	1-3/4"	900	2.91	16	98.66
JR-S-10NL	DICKEN	1"	1"	4-1/2" - 12"	1-3/4"	1500	3.00	12	151.82
PA-100NL *	BII	1"	1"	5" - 12"	1-3/4"	2000	2.95	16	103.45
P-100NL	SEALWELL	1"	1"	5" - 12"	1-3/4"	2000	3.25	16	124.85
LD-S-10NL	DICKEN	1"	1"	5" - 12"	1-3/4"	2000	4.50	12	234.80
PA-125NL *	BII	1-1/4"	1-1/4"	5" - 12"	2-1/8"	2000	4.90	10	180.40
LD-S-12NL	DICKEN	1-1/4"	1-1/4"	5" - 12"	2-1/8"	2000	5.50	8	371.24
PA-200NL *	BII	2"	2"	5-5/8" - 12"	3-1/8"	5000	14.25	4	457.24
S-20NL	DICKEN	2"	2"	5-5/8" - 12"	3-1/8"	5000	14.25	4	738.82

Note: 1-1/2" Pitless Adapter available in stainless steel (P-150-SS) *



LISTED PAS-97 (2012)

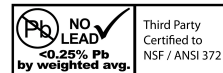

PRESSURIZED PITLESS ADAPTERS

- For installations requiring a pressurized point of attachment. A small hole between the internal and external gaskets ensures positive pressure at the seal to the well casing. Pressurized pitless are stamped with a "P" on the top of the slide portion of the pitless for identification after installation
- Approved for use in the State of Illinois

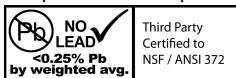

LISTED PAS-97 (2012)



PART NO.	SIZE	DROP PIPE CONNECTION	WELL CASING SIZE RANGE	HOLE SAW SIZE	WORKING LOAD-lbs	SHIPPING WGT-lbs	QUANTITY CTN	LIST PRICE-A
PA-100-PNL *	1"	1"	5" - 12"	1-3/4"	2000	2.95	16	176.36
PA-125-PNL *	1-1/4"	1-1/4"	5" - 12"	2-1/8"	2000	4.90	10	257.91

STAINLESS STEEL PITLESS ADAPTERS

- #304 Stainless Steel
- Large gasket for more efficient sealing on casing
- Chamfered slide for easy installation



LISTED PAS-97 (2012)



PART NO.	MAKE	SIZE	DROP PIPE SIZE	CASING SIZE	HOLE SAW SIZE	WORKING LOAD-lbs	SHIPPING WGT-lbs	QUANTITY CTN	LIST PRICE-A
P-800-SS	BII	1"	1"	5" - 12"	1-3/4"	6000	2.65	18	96.72
P-100-SS *	BII	1"	1"	5" - 12"	1-3/4"	6000	3.25	18	138.40
P-125-SS *	BII	1-1/4"	1-1/4"	5" - 12"	2-1/8"	6000	4.90	8	196.88
P-150-SS *	BII	1-1/2"	1-1/2"	5" - 12"	2-1/2"	6000	9.42	4	394.80
P-200-SS *	BII	2"	2"	5" - 12"	3-1/8"	6000	13.30	4	504.79



TAPPED PITLESS ADAPTERS - FOR UNDERGROUND TANKS / DIRTY WATER

- 1-1/4" and 2" Tapped Pitless are for dirty water applications. The 1/4" FPT tapping provides a means to connect a 1/4" pipe to the pitless to allow easy removal of the pitless unit and pump. The pipe is guided by a rail/guide system that aligns the pitless elbow with the pitless slide when reinstalling (railing or guide system not included).

PART NO.	SIZE	TAPPING	QUANTITY CTN	LIST PRICE-A
1-1/4" units are used with grinder pumps				
PA-125-TNL	1-1/4" Bronze	1/4"	10	257.91
P-125-SS-T	1-1/4" Stainless Steel	1/4"	8	230.14
2" units are used with all other sewage pumps				
PA-200-TNL	2" Bronze	1/4"	4	522.77
P-200-SS-T	2" Stainless Steel	1/4"	4	573.69



Also Available:

- 1" Tapped Pitless are for underground water well tank installations. The 1/4" FPT tapping provides a means to connect poly tubing to the pressure switch which is located near the buried tank.
- | PART NO. | SIZE | TAPPING | QUANTITY CTN | LIST PRICE-A |
|------------|--------------------|---------|--------------|--------------|
| PA-800-TNL | 1" Bronze | 1/4" | 16 | 168.12 |
| P-100-SS-T | 1" Stainless Steel | 1/4" | 16 | 208.26 |

BOSHART INDUSTRIES

11-2
April 27/20

Telephone: 1-519-595-4444 - Toll Free: 1-800-561-3164
Fax: 1-519-595-4380 - www.boshart.com

CONCRETE TILE PITLESS ADAPTER

Manufactured to the same specifications as a PA-100NL & PA-125NL pitless adapter with an extended shank to allow the pitless slide to be installed through a cement casing with a maximum thickness of 3" .
1-1/4" Pitless are ideal for sewage disconnects for grinder pumps in cement tanks.



PART NO.	SIZE	DROP PIPE CONNECTION	CONCRETE TILE SIZE RANGE	HOLE SAW SIZE	WORKING LOAD-lbs	SHIPPING WGT-lbs	QUANTITY		LIST PRICE-A
							CTN	CASE	
PA-100-CTNL	1"	1"	12" - 48"	1-3/4"	2000	4.2	12		158.37
PA-125-CTNL	1-1/4"	1-1/4"	12" - 48"	2-1/8"	2000		10		288.71

DOUBLE DROP PIPE PITLESS ADAPTER

PART NO.	MAKE	DROP PIPE SIZE	CASING SIZE	HOLE SAW SIZE	WORKING LOAD-lbs	SHIPPING WGT-lbs	QUANTITY		LIST PRICE-A
							CTN	CASE	
LD-2XNL	DICKEN	1" & 1-1/4"	4 1/2" - 12"	1-3/4" & 2-1/8"	2000	11.56	6		581.26
PA-2XNL *	BII	1" & 1-1/4"	4 1/2" - 12"	1-3/4" & 2-1/8"	2000	8.60	6		367.22



LISTED PAS-97 (2012)

DICKEN "WRAP AROUND" FOR PVC CASING

PART NO.	CASING SIZE		DROP PIPE SIZE	WORKING LOAD-lbs	SHIPPING WGT-lbs	QUANTITY		LIST PRICE-A
	I.D.	O.D.				CTN	CASE	
CW-4-10-WANL	4"	4-1/2"	1"	2000	4.75	6		405.44
CW-4.5-10-WANL	4-1/2"	5"	1"	2000	6.25	6		439.60
CW-5-10-WANL	5"	5-9/16"	1"	2000	6.50	6		447.29



DICKEN "CLEAR WAY" FOR STEEL CASING

PART NO.	CASING SIZE		DROP PIPE SIZE	WORKING LOAD-lbs	SHIPPING WGT-lbs	QUANTITY		LIST PRICE-A
	I.D.	O.D.				CTN	CASE	
CW-4-10NL	4"	4-1/2"	1"	2000	4.75	6		356.33
CW-5-10NL	4-1/2"	5"	1"	2000	4.75	6		367.23
	5"	5-9/16"						
CW-6-10NL	5-5/8"	6"	1"	2000	6.0	6		429.20
	6"	6-5/8"						



BOSHART INDUSTRIES

Telephone: 1-519-595-4444 - Toll Free: 1-800-561-3164

Fax: 1-519-595-4380 - www.boshart.com

11-3
April 27/20

BRONZE WIRE SPUDS

PART NO.	DESCRIPTION	CTN/ CASE	LIST PRICE-A
WS-100	1" FPT - Use 1-3/4" Hole Saw	Bulk	79.46



PITLESS INSTALLATION - HOLE SAWS & ACCESSORIES

- High speed steel cutting edge is electron-beam welded to a tough alloy back
- Cuts clean, accurate holes in virtually any machinable material
- Knockout holes allow easy removal of cores
- Available in diameters from 9/16" to 6"

PART NO.	DESCRIPTION	USE TO INSTALL	LIST PRICE-A
28-HS114	1-1/4" Hole Saw	- - -	30.18
28-HS134	1-3/4" Hole Saw	1" Pitless	39.70
28-HS178	1-7/8" Hole Saw	- - -	39.70
28-HS218	2-1/8" Hole Saw	1-1/4" Pitless	49.41
28-HS214	2-1/4" Hole Saw	- - -	49.41
28-HS238	2-3/8" Hole Saw	- - -	49.41
28-HS212	2-1/2" Hole Saw	1-1/2" Pitless	51.35
28-HS234	2-3/4" Hole Saw	- - -	51.35
28-HS318	3-1/8" Hole Saw	2" Pitless	54.36
28-HSPD	Pilot Drill	- - -	12.80

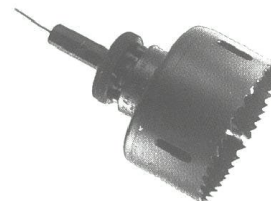

7/16" HEX SHANK QUICK CHANGE ARBOR

- Hex shank prevents slippage in chuck
- Provides fast interchanging of hole saws without arbor removal from chuck
- Pin drive feature
- For hole saws 1-1/4" to 6" diameter

PART NO	DESCRIPTION	LIST PRICE-A
28-HSA	7/16" Hex shank quick change	53.21



SILICONE LUBRICANT

- Retains its consistency and properties over a temperature range of -50°C to 200°C (-55°F to 390°F)
- Highly water repellent and resistant to oxidation
- Mild chemical barrier coating
- Retains paste-like consistency and will not soften or flow
- NSF H-1 Registered Product

PART NO	SIZE	LIST PRICE-A
P-LUBE	4 oz (113 g) Plastic Tube	29.41



BOSHART INDUSTRIES

11-4
April 27/20

Telephone: 1-519-595-4444 - Toll Free: 1-800-561-3164
Fax: 1-519-595-4380 - www.boshart.com

MAASS "J" SERIES PITLESS ADAPTERS

- Water contacts only 304 stainless steel and bronze, to eliminate rust, corrosion, and electrolysis in the water system.
- Durable cast steel housing
- Tapered 8° slip fitting for easy installation and removal of bronze insert
- No obstruction left in well casing when brass insert is pulled
- Designed for shallow or deep settings and high working pressures



Cutting Guides available to cut holes in casing with Torch. Cutting guides not listed in the catalogue. Call Sales Rep for price and delivery.

PART NO.	CONNECTION		WELL CASING SIZE O.D.	WORKING LOAD - lbs	WEIGHT	LIST PRICE-A
	OUTLET	DROP				
09-4J1.25NL	1-1/4"	1-1/4"	4" - 5"	5,000	7.0	394.28
09-4J1.5NL	1-1/2"	1-1/2"	4" - 5"	5,000	8.5	523.63
09-5J2NL	2"	2"	5"	6,000	12.0	757.81
09-6J1.5NL	1-1/2"	1-1/2"	6" or larger	5,000	8.5	523.63
09-6J2NL	2"	2"	6" or larger	5,000	12.0	757.81
09-6J2.5NL	2-1/2"	2-1/2"	6" or larger	8,000	18.0	1374.45
09-8J3NL	3"	3"	8" or larger	10,000	32.0	2383.77
09-10J4NL	4"	4"	10" or larger	16,000	50.0	3403.00

NOTE: The weight of the pump, pipe and water column should not exceed the working load of the adapter nor the NPT joint strength of the pipe.

CLAMP-ON TYPE MAASS "JC" SERIES PITLESS ADAPTERS

- Durable cast steel housing and has two steel lips resting on the wall of the well casing to support the pitless adapter in position
- 8° bronze locking type wedge with an o-ring forced against non-magnetic type 304 stainless steel flange nipple
- Cast steel housing will have a neoprene gasket for sealing the housing to the outside of the well casing and the housing will be held in place with two 304 stainless steel straps and stainless steel hardware

PART NO.	CONNECTION		ADAPTER HOUSING SIZE	WELL CASING O.D.	WORKING LOAD - lbs	WEIGHT	LIST PRICE-A
	OUTLET	DROP					
09-4JC1NL	1"	1"	4"	4-1/2"	4,000	11	377.08
09-5ODJC1NL	1"	1"	5" O.D.	4.950" -5"	4,000	11	387.37
09-5JC1NL	1"	1"	5"	5 9/16"	4,000	11	387.37
09-6ODJC1NL	1"	1"	6" O.D.	5.9 to 6"	4,000	11.75	408.34
09-6JC1NL	1"	1"	6"	6-5/8"	4,000	11.75	408.56
09-7JC1NL	1"	1"	7"	7"	4,000	12	569.45
09-4JC1.25NL	1-1/4"	1-1/4"	4"	4-1/2"	4,000	11.75	462.49
09-5ODJC1.25NL	1-1/4"	1-1/4"	5" O.D.	4.95" to 5"	4,000	11.25	484.24
09-5JC1.25NL	1-1/4"	1-1/4"	5"	5-9/16"	4,000	11.25	484.24
09-6ODJC1.25NL	1-1/4"	1-1/4"	6" O.D.	5.9" to 6"	4,000	12.75	489.72
09-6JC1.25NL	1-1/4"	1-1/4"	6"	6-5/8"	4,000	12.75	489.72
09-7JC1.25NL	1-1/4"	1-1/4"	7"	7"	4,000	13	614.28

NOTE: The weight of the pump, pipe and water column should not exceed the working load of the adapter nor the NPT joint strength of the pipe.

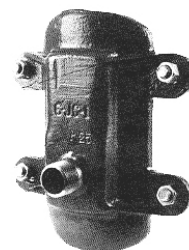

Ideal for use on either plastic or steel well casing.

MODEL JX1 - PITLESS BURY UNITS



Pitless Bury Units available.

"J" Series Pitless - Factory welded to casing. Units can be threaded or plain end and made for any bury depth (specify when ordering). Contact your Sales Representative for detailed spec sheets.

BOSHART INDUSTRIES

Telephone: 1-519-595-4444 - Toll Free: 1-800-561-3164

Fax: 1-519-595-4380 - www.boshart.com

11-5

October 29/15

BII INDUSTRIAL PITLESS

Both ductile iron and stainless steel industrial pitless are provided with numerous features as standard equipment, which you will find listed below. This will make the BII Industrial Pitless the most versatile on the market. The BII design allows for the installer to purchase and field install additional accessories and equipment later on without any specialized fabrication / welding with significant cost savings for the installer.

Features

- Flanged Casing Connections
- ASA Class 150 Flanged Discharge Connection
- Sealable through Pipe Connections for Flowing Wells
- Pressure Zone Tapped for Sampling Faucet
- Baked Epoxy Coating (NSF 61 Certified)

Industrial Pitless

- Includes Housing and Spool

SIZE	EPOXY COATED DUCTILE IRON PART NO.	LIST PRICE-A	304 STAINLESS STEEL PART NO.	LIST PRICE-A
8"	IPD08	POR	IPS08	POR
10"	IPD10	POR	IPS10	POR
12"	IPD12	POR	IPS12	POR

Industrial Pitless Kits

- Includes Industrial Pitless and Cast Iron Cap

SIZE	EPOXY COATED DUCTILE IRON KIT PART NO.	LIST PRICE-A	304 STAINLESS STEEL KIT PART NO.	WELL CAP PART NO.	LIST PRICE-A
8"	IPD08-KIT	POR	IPS08-KIT	WTCL-C10	POR
10"	IPD10-KIT	POR	IPS10-KIT	WTCL-C12	POR
12"	IPD12-KIT	POR	IPS12-KIT	WTCL-C14	POR



Epoxy Coated Ductile Iron



304 Stainless Steel

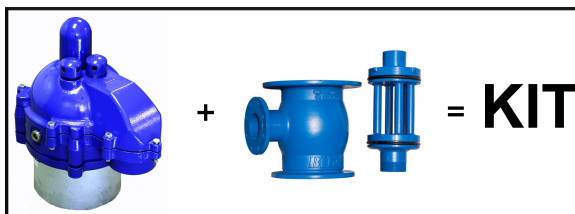

BII INDUSTRIAL PITLESS UNIT

The BII Industrial Pitless Units are designed and precision-machined for heavy duty municipal and industrial water well installations.

All Pitless Units are hydrostatic pressure tested at the factory and shipped complete with a BII WTCL Series Premium Watertight Well Cap. Upper casing barrels, torque arrestor / hold-down assemblies are optional.

BOSHART INDUSTRIES

11-6

Telephone: 1-519-595-4444 - Toll Free: 1-800-561-3164

Fax: 1-519-595-4380 - www.boshart.com

BII INDUSTRIAL PITLESS UNIT

- A - **Locking Watertight Sanitary Well Cap**
- See section 11 for detailed information.
- B - **Screened Air Vent** - Screened Air Vent threads into a 2" FPT port in top of well cap. The screen is 60-mesh, stainless steel with large open area and is protected by a dome shaped cover.
- C - **Access Port** - 1-1/2" MPT cap plug aligns with one of the five through passages in the spool for easy alignment of a probe tube.
- D - **Access Port** - 2" MPT cap plug aligns with pressure chamber tapping in the spool top plate for installation of a sampling faucet as required.
- E - **Cable Seal** - Stainless steel cable seals are available to seal the well chamber from the conduit to ensure no contamination enters the well through the conduit. They are also watertight and vermin proof.
- F - **Access Ports** - The middle ring is equipped with two additional 1" FPT accessory ports to allow for installation of additional accessories such as air line test blocks, chlorinators or auxiliary sensor cables.
- G - **Conduit Connection** - Large 4" FPT connection.
- H - **Conduit Splitter** - 4" MPT bushing splits the large conduit into two smaller conduit connections (1) 2" FPT for power cable and (1) 1" FPT typically used to run a transducer wire in a separate conduit to eliminate interference.
- I - **Upper Barrel** - Available by special order without significant delay. It is supplied with black paint finish. Total upper barrel length (UB), bury depth (BD) and above ground dimension (AG) must be specified. All Upper Barrels are supplied with 24" of casing above ground.
- J - **Torque Arrestor / Hold-Down Assembly** - Optional - 6 bolts secure the spool to prevent spool from both vertical and rotational movement due to up thrust and or pump start-up torque.
- K - **Lift-Out Connection** - All units are supplied with FPT connections.
- L - **Spool** - Five through holes serve as pressure equalization passages in addition to access for pump cables, airlines, controls, chlorination equipment, testing and measurement equipment.
- M - **Spool Drop Pipe Connection** - Drop pipe connections are FPT standard. API threading is available by special order.
- N - **Discharge Housing** - Globe design provides excellent flow and precision machined O-ring seats ensure a positive seal. Ductile housings are epoxy coated inside and out; stainless steel housings are coated on the outside only.
- O - **Upper Barrel Connection** - All Industrial Pitless are equipped with raised face flanges as standard equipment for a quick and easy attachment to an ASA Class 150 flanged upper barrel casing.
- P - **Discharge Connection** - All Industrial Pitless are supplied with ASA Class 150 raised face flanges. Various adapters to pipelines are available by special order.
- Q - **Well Casing Connection** - All Industrial Pitless are equipped with raised face flanges as standard equipment for a quick easy attachment to ASA Class 150 raised face flanges that are equal in size to the well casing. Weld neck or quick connect casing flanges are available as an option.
- R - **Well Casing**
- S - **Check Valve(s)** - A wide range of high quality check valves are available in both ductile iron and stainless steel, traditional and specially designed checks for VFD pumps are in stock.
- T - **Drop / Riser Pipe**

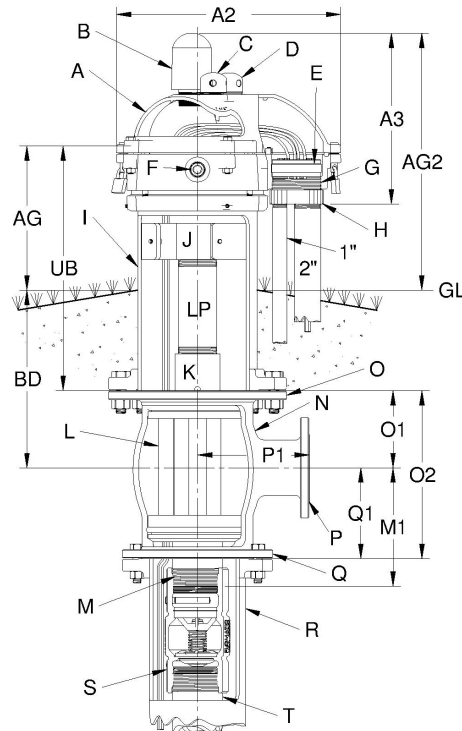

Bury Depth (BD) - Bury depth is from the center of the discharge line to ground level (GL).

Ground Level (GL) - The final ground level / grade must be determined in order to determine the appropriate cut-off point for the well casing prior to installation. The grade must slope away from the well casing for proper drainage. Always refer to local regulations for well installations.

Above Grade / Ground Level (AG) - This dimension must be determined prior to production of the upper barrel.

Refer to local regulations and AHJ's for well installation. All Upper Barrels are supplied with 24" of casing above ground.

BOSHART INDUSTRIES

Telephone: 1-519-595-4444 - Toll Free: 1-800-561-3164

Fax: 1-519-595-4380 - www.boshart.com

11-7
April 27/20

WCC SERIES BII CONDUIT WELL CAPS

ALUMINUM CONDUIT CAPS

- Heavy duty design for added durability
- Designed to provide extra clearance for pump cable
- Three stainless steel set screws for secure fit to well casing
- One stainless steel set screw to secure conduit pipe
- A well log is provided inside each cap to record installation data/specifications



PART NO.	CASING SIZE (IN)		CONDUIT PIPE SIZE	UNIT WGT - lbs	QTY CASE	LIST PRICE-A
	I.D.	O.D.				
WCC-A04	4"	4-1/2"	1"	1.25		21.02
WCC-A045	4-1/2"	5"	1"	1.20		24.79
WCC-A05	5"	5-9/16"	1"	1.40		26.08
WCC-A056	5-5/8"	6"	1"	1.50		29.95
WCC-A06	6"	6-5/8"	1"	1.75		28.47
WCC-A066	6-5/8"	7"	1"	1.80		31.28
WCC-A08	8"	8-5/8"	1"	2.50		57.96
WCC-A10	10"	10-3/4"	1"	3.00		111.23



WCCL SERIES BII ALUMINUM LOCKING CONDUIT CAPS

- Stainless steel set screws
- Locking feature provides a secure/tamper-proof installation

PART NO.	CASING SIZE (IN)		CONDUIT PIPE SIZE	UNIT WGT - lbs	QTY CASE	LIST PRICE-A
	I.D.	O.D.				
WCCL-A06	6"	6-5/8"	1"	2.0		28.61



Note: Locks not included.
For illustration purposes only.

CC SERIES CAST IRON CONDUIT CAPS

- Heavy cast iron construction
- Quick installation
- Blue painted finish
- Packaged individually



PART NO.	CASING SIZE (IN)		CONDUIT PIPE SIZE	QUANTITY		CTN/CASE SHIPPING WGT - lbs	LIST PRICE-A
	I.D.	O.D.		CTN	CASE		
CC-6-CI	6, 6-1/4"	6-5/8"	1"	12		5/35	39.95



WCP SERIES BII PLAIN WELL CAPS

ALUMINUM PLAIN CAPS

- Heavy duty design for added durability
- Uses three stainless steel set screws for secure fit to well casing
- A well log is provided inside each cap to record installation data/specifications

PART NO.	CASING SIZE (IN)		CONDUIT PIPE SIZE	UNIT WGT - lbs	QTY CASE	LIST PRICE-A
	I.D.	O.D.				
PC-4	4"	4-1/2"	1"	0.87		36.83
PC-566	5-5/8"	UPPER 6"	1"	1.87		73.53
(2-STEP)	6"	LOWER 6-5/8"	1"			
WCP-A06	6"	6-5/8"	1"	1.50		25.45
PC-66	6-5/8"	7"	1"	2.19		78.33



WCP Series



PC Series "Dicken"
(1 set screw only)

PERSONALIZED CAPS are available. Please contact your Sales Rep for further information and delivery.

BOSHART INDUSTRIES

11-8
April 27/20

Telephone: 1-519-595-4444 - Toll Free: 1-800-561-3164
Fax: 1-519-595-4380 - www.boshart.com

WTC SERIES BII WATERTIGHT WELL CAPS - FOR STEEL OR PVC WELL CASING

- Easy to install, easy access for maintenance
- Vermin proof with large screened air vents
- Greater clearance for submersible pump cable
- Stainless steel hardware
- O-ring system ensures reliable watertight seal between well casing and retainer ring
- A second O-ring is used to seal cover and retainer ring, a positive compression seal is achieved by tightening 4 bolts
- Grounding terminal with bolt provided
- A well log is provided inside each cap to record installation data/specifications



PART NO.	CASING SIZE (IN)		CONDUIT CONNECTION	AIR VENTS	UNIT WGT - lbs	QTY CASE	LIST PRICE-A
	I.D.	O.D.					
ALUMINUM							
WTC-A04	4"	4-1/2"	1" FPT	(2) 3/4"	3.00	16	55.66
WTC-A05	5"	5-9/16"	1" FPT	(2) 3/4"	3.25	12	60.98
WTC-A06	6"	6-5/8"	1" FPT	(2) 3/4"	4.00	12	66.47
WTC-A06-BLUE	6"	6-5/8"	1" FPT	(2) 3/4"	4.00	12	76.51
WTC-A06-12	6"	6-5/8"	1-1/4" FPT	(2) 3/4"	4.00	12	68.47
WTC-A06-12-BLUE	6"	6-5/8"	1-1/4" FPT	(2) 3/4"	4.00	12	78.80
WTC-PA06 *	6"	6 5/8"	1" FPT	(2) 3/4"	2.50	12	61.14
CAST IRON - Durable Blue Powder Coat Paint							
WTC-C06	6"	6-5/8"	1" FPT	(2) 3/4"	9.5	6	86.27
WTC-C06-12	6"	6-5/8"	1-1/4" FPT	(2) 3/4"	9.5	6	88.86



WTC Series



WTC-A06-BLUE
(Durable Powder Coat Paint)



*WTC-PA06
(PVC cover c/w Alum. lower ring for steel casing)



WTC-C06
(Durable Powder Coat Paint)

8, 10 and 12" available in locking style only, see WTCL series, Page 11-10

WTC-G SERIES BII WATERTIGHT CAPS FOR PVC WELL CASING

- Same design as the above WTC Series but with exception that the lower ring is plastic which can be solvent welded directly to PVC well casing
- Durable UV stabilized, high impact ABS



PART NO.	CASING SIZE (IN)		CONDUIT CONNECTION	AIR VENTS	UNIT WGT - lbs	QTY CASE	LIST PRICE-A
	I.D.	O.D.					
WTC-G-P0625-06 *	6" or 6-1/4"	6-5/8" or 6.9"	1" FPT	(2) 3/4"	1.93	12	45.24
WTC-G-P0625	6-1/4"	6.90"	1" FPT	(2) 3/4"	1.75	12	40.90
WTC-G-AP0625-06 *	6" or 6-1/4"	6-5/8" or 6.9"	1" FPT	(2) 3/4"	2.93	12	56.41
WTC-G-AP0625	6-1/4"	6.90"	1" FPT	(2) 3/4"	2.75	12	52.08

* New models of well caps for 6-5/8" well casing are now available. These caps are the 6-1/4" well caps for 6.9" O.D. casing shipped with a Part No. WCCA-G0625-G06 6.9" X 6-5/8" well cap casing adapter included. The reducing adapter is not glued into the well cap so that the end user has the flexibility to use the cap for either a 6.9" O.D. or a 6-5/8" O.D. casing. This also gives the option to reduce inventories for those customers who have both casing sizes in their territory, ensuring they never end up at a job site with the wrong size well cap.



WTC-G-P0625
ABS top with
ABS glue-on
lower ring



WTC-G-AP0625
Aluminum top with
ABS glue-on lower
ring



WTC-G-P0625-06
consists of
WTC-G-P0625 well cap
plus a
WCCA-G0625-G06 ring
WTC-G-AP0625

WELL CAP CASING ADAPTER

PART NO	SIZE	UNIT WGT-lbs	QTY CTN	LIST PRICE-A
WCCA-G0625-G06	6.9" X 6-5/8"	0.175	12	2.89

Well cap casing adapters (reducer rings) can be purchased separately if desired. If an account would prefer the option of stocking the 6-1/4" well caps for 6.9" O.D. well casing and selling the rings as a separate component. The rings are individually bagged and include installation information.



WCCA-G0625-G06 ring
glued on a 6-5/8"
casing

BOSHART INDUSTRIES

Telephone: 1-519-595-4444 - Toll Free: 1-800-561-3164

Fax: 1-519-595-4380 - www.boshart.com

11-9
April 27/20

WTMLC SERIES BII LOCKING WATERTIGHT WELL CAPS - FOR STEEL OR PVC WELL CASING

ALUMINUM WATERTIGHT LOCKING CAPS

- Easy to install, easy access for maintenance
- Vermin proof with large screened air vents
- Stainless steel hardware
- O-ring system to ensure reliable seal to casing
- A second O-ring is used to seal cover and retainer ring, a positive compression seal is achieved by tightening a single set screw on a specially designed tapered surface ensuring a positive seal
- Locking feature provides a secure/tamper-proof installation
- Grounding terminal with bolt provided
- A well log is provided inside each cap to record installation data/specifications



Note:
Locks not included.
For illustration
purposes only.

PART NO.	CASING SIZE (IN)		CONDUIT CONNECTION	AIR VENTS	UNIT WGT - lbs	QTY CASE	LIST PRICE-A
	I.D.	O.D.					
WTMLC-A04	4"	4-1/2"	1" FPT	(2) 3/4"	3.26	20	63.01
WTMLC-A045	4-1/2"	5"	1" FPT	(2) 3/4"	3.55	16	66.94
WTMLC-A045-BLUE	4-1/2"	5"	1" FPT	(2) 3/4"	3.55	16	76.98
WTMLC-A05	5"	5-9/16"	1" FPT	(2) 3/4"	3.70	16	69.78
WTMLC-A05-BLUE	5"	5-9/16"	1" FPT	(2) 3/4"	3.70	16	79.93
WTMLC-A056-BLUE	5-5/8"	6"	1" FPT	(2) 3/4"	3.92	16	83.92
WTMLC-A06	6"	6-5/8"	1" FPT	(2) 3/4"	3.95	12	73.65
WTMLC-A06-BLUE	6"	6-5/8"	1" FPT	(2) 3/4"	3.95	12	85.28
WTMLC-A06-12	6"	6-5/8"	1-1/4" FPT	(2) 3/4"	3.95	12	75.10
WTMLC-A066	6-5/8"	7"	1" FPT	(2) 3/4"	3.53	12	91.51

WTMLC-G SERIES BII LOCKING WATERTIGHT WELL CAPS - FOR STEEL OR PVC WELL CASING

LOCKING CAPS - ALUMINUM COVER WITH GLUE-ON ABS RING

PART NO.	CASING SIZE (IN)		CONDUIT CONNECTION	AIR VENTS	UNIT WGT - lbs	QTY CASE	LIST PRICE-A
	I.D.	O.D.					
WTMLC-G-AP04	4"	4.500"	1" FPT	(2) 3/4"	2.03	20	51.25
WTMLC-G-AP045	4-1/2"	4.950"	1" FPT	(2) 3/4"	2.18	16	54.03
WTMLC-G-AP05	5"	5.563"	1" FPT	(2) 3/4"	2.36	16	55.70
WTMLC-G-AP0625	6-1/4"	6.900"	1" FPT	(2) 3/4"	2.40	12	62.88

* A well cap for 6-5/8" well casing is now available. These caps are the 6-1/4" well caps for 6.9" O.D. casing shipped with a Part No. WCCA-G0625-G06 6.9" X 6-5/8" well cap casing adapter included. The reducing adapter is not glued into the well cap so that the end user has the flexibility to use the cap for either a 6.9" O.D. or a 6-5/8" O.D. casing. This also gives the option to reduce inventories for those customers whom have both casing sizes in their territory, ensuring they never end up at a job site with the wrong size well cap.



WTMLC-G-AP0625-06 consists of WTMLC-G-AP0625 well cap plus a WCCA-G0625-G06 ring

WELL CAP CASING ADAPTER

PART NO	SIZE	UNIT WGT-lbs	QTY		LIST PRICE-A
			CTN	CASE	
WCCA-G0625-G06	6.9" X 6-5/8"	0.175	12		2.89

Well cap casing adapters (reducer rings) can be purchased separately if desired. If an account would prefer the option of stocking the 6-1/4" well caps for 6.9" O.D. well casing and selling the rings as a separate component. The rings are individually bagged and include installation information.



WCCA-G0625-G06 ring glued on a 6-5/8" casing

BOSHART INDUSTRIES

11-10
April 27/20

Telephone: 1-519-595-4444 - Toll Free: 1-800-561-3164
Fax: 1-519-595-4380 - www.boshart.com

WTCC SERIES WATERTIGHT LOCKING CAPS - CAST IRON

- Rugged cast iron construction with durable blue powder coat paint finish
- Vermin Proof design c/w two large stainless steel screened vents
- Locking feature provides a secure / tamper proof installation
- Wide gasket provides a positive compression seal between the well casing and cap as well as the cap cover and retainer ring, compression is achieved by tightening 5 bolts
- Deep, forgiving pocket designed for sealing unevenly cut casing - gasket will seal as far as 1-1/2" from the top of the casing
- Increased clearance for the pump cable



PART NO.	CASING SIZE (IN)		CONDUIT CONNECTION	AIR VENTS	UNIT WGT - lbs	QTY CASE	LIST PRICE-A
	I.D.	O.D.					
WTCC-6-CI	6" , 6-1/4"	6-5/8"	1" FPT	(1) 1/2"	10.5	6	92.39
WTCC-6-CI-12	6" , 6-1/4"	6-5/8"	1-1/4" FPT	(1) 1/2"	10.5	6	102.12
WTCC-66-CI	6-5/8"	7"	1-1/4" FPT	(2) 3/4"	11.18	6	115.42



8" , 10" , 12" WTCL SERIES BII WATERTIGHT LOCKING WELL CAPS

ALUMINUM WATERTIGHT LOCKING CAPS

- Easy to install, easy access for maintenance
- Vermin proof with large screened air vents
- Stainless steel hardware
- O-ring system to ensure reliable seal to casing
- A second O-ring is used to seal cover and retainer ring, a positive compression seal is achieved by tightening 6 bolts
- Locking feature provides a secure/tamper-proof installation
- Grounding terminal with bolt provided
- A well log is provided inside each cap to record installation data/specifications



Note:
Locks not included.
For illustration purposes only.

PART NO.	CASING SIZE (IN)		CONDUIT CONNECTION	AIR VENTS	UNIT WGT - lbs	QTY CASE	LIST PRICE-A
	I.D.	O.D.					
WTCL-A08	8"	8-5/8"	1-1/4" FPT	(2) 3/4"	5.25	8	143.37
WTCL-A10	10"	10-3/4"	1-1/4" FPT	(2) 3/4"	6.00	5	345.07
WTCL-A12	12"	12-3/4"	1-1/4" FPT	(2) 3/4"	6.50	5	429.23



PREMIUM WATERTIGHT CAST IRON LOCKING CAP - FOR STEEL OR PVC WELL CASING

- Absolutely the EASIEST & FASTEST heavy duty well cap to install, easy to access well for maintenance.
- Only tools required are (2) 9/16" wrenches, (1) 5/32" Allen Wrench.
- Three Piece Heavy Duty design, cast from high quality grey cast iron, with a durable blue powder coat paint, which is baked to ensure superior quality.
- All hardware is Stainless Steel for maximum corrosion resistance (No Plated Fasteners)
- Thick soft SBR rubber gasket ensures a positive watertight compression seal to the well casing, the cap has a deep socket to ensure the gasket seals down from the top edge of the well casing.
- Top cover is sealed to the lower assembly by compressing a soft, thick durable SBR gasket, cover can easily be removed without disturbing the seal to the well casing, or interfering with the wiring or conduit.
- Large 2" FPT conduit connection provides lots of room for heavy gauge submersible pump cables.
- Large 2" mushroom vent cap with SS screen is included to ensure the cap is Vermin Proof.
- Replacement of the vent with a standard 2" MPT thread plug quickly converts this vented well cap into a truly watertight cap where and when required.
- Caps are supplied with a ground bolt and two tongue ring terminal connectors. Three S.S. grounding set screws bond the well cap to the well casing (steel)
- Locking feature provides a secure / tamper proof design, simply insert a pad lock thru the S.S. locking pin.
- Personalization is available by means of an engraved aluminum plate which is affixed by drive rivets.

PART NO.	CASING SIZE (IN)		CONDUIT CONNECTION	AIR VENTS	UNIT WGT - lbs	QTY CASE	LIST PRICE-A
	I.D.	O.D.					
WTCL-C08	8"	8-5/8"	2" FPT	(1) 2" MVC	32.04		872.05



LISTED PAS-97 (2012)

BOSHART INDUSTRIES

Telephone: 1-519-595-4444 - Toll Free: 1-800-561-3164

Fax: 1-519-595-4380 - www.boshart.com

11-11
April 27/20

PREMIUM WATERTIGHT CAST IRON CAP WITH SCREENED AIR VENT

Features:

- Provides easy access to the well without interfering with seal to casing or conduit and wiring.
- Large 4" FPT conduit connection
- Locking feature provides a **secure / tamper proof design**.
- Easily converts to 100% water proof design by replacing the vent with a plug.
- Comes with 2 lockable accessory ports.
- Caps are **supplied with a grounding terminal and the metal cap is bonded to the steel casing with 3 set screws**.
- Two 1" FPT Ports are provided for field installation of accessories.

Construction:

- Three Piece Heavy Duty design
- High quality grey cast iron castings
- Durable blue powder coat paint, which is baked to ensure superior quality finish.
- Thick heavy duty SBR Gaskets.
- All hardware is Stainless Steel for maximum corrosion resistance

PART NO.	CASING SIZE (IN) I.D. O.D.	CONDUIT CONNECTION	AIR VENTS (sq in)/Mesh	UNIT WGT - lbs	QTY CASE	LIST PRICE-A
WTCL-C10	10.02" 10-3/4"	4" FPT	10.5 / 60	90		3003.71
WTCL-C12	12" 12-3/4"	4" FPT	10.5 / 60	110		3456.93
WTCL-C14	13.18" 14"	4" FPT	10.5 / 60	120		3708.26



Stop tab allows for easy & accurate positioning of lower assembly (see back)



PREMIUM WATERTIGHT CAST IRON WELL CAP ACCESSORIES

Conduit Adapter

- Converts 4" FPT conduit connection on 10" , 12" & 14" WTCL-C series well cap in to two conduit connections (1) 2" FPT and (1) 1" FPT allowing the separation of the power cable from other sensor wiring which maybe subject to interference if run beside the power cable in a single large conduit pipe.
- Heavy duty Cast Iron construction, with durable blue powder coat paint to match well caps

PART NO.	WELL CAP CONNECTION	CONDUIT CONNECTION	CTN	QUANTITY CASE	LIST PRICE-A
WTCL-CA40-2010	4" MPT	2" FPT x 1" FPT	12		167.19

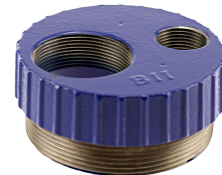

Cable Seal Assembly

- Provides a watertight / vermin proof barrier between the conduit piping and the well chamber of the well cap
- Stainless steel plates (top & bottom) along with stainless hardware provide maximum corrosion resistance
- Compressible SBR rubber gasket provides a positive seal to the well cap pocket and the pump power cables, available in 5 cable hole sizes to accommodate #14 AWG thru 4/0 pump cable.

4 WIRE SEAL PART NO.	OUTSIDE DIAMETER	CABLE RANGE DIAMETER	PUMP CABLE CAN.	AWG U.S.A.	LIST PRICE-A
WTCL-CS40-312-4					478.41
WTCL-CS40-437-4					478.43
WTCL-CS40-563-4					478.43
WTCL-CS40-700-4					478.43



Note: For a cable seal assembly to use with 3 wire pump cable, change part number suffix to -3 (ie: WTCL-CS40-315-3)

Vent Cap

- Heavy duty cast iron construction
- 60 mesh stainless steel screen
- 2" MPT thread, comes with cotter key to lock vent in place

PART NO.	WELL CAP SIZE	LIST PRICE-A
WTCL-VC-08	8"	35.82
WTCL-VC-1014	10" , 12" , & 14"	78.66



Locking Pin

- 304 S.S. locking pin for accessory ports on 10" , 12" & 14" WTCL-C series well cap
- 5/16" diameter hole for lock

PART NO.	SIZE	LIST PRICE-A
WTCL-CLP	0.55" dia x 4.375" length	21.53



Depth Tester Kit

- Please contact your Sales Rep for product details and pricing

PART NO.	LIST PRICE-A
----------	--------------

Water Sampling Valve Kit

- Please contact your Sales Rep for product details and pricing

PART NO.	LIST PRICE-A
WSVK05-12	802.14



BOSHART INDUSTRIES

11-12
March 30/20

Telephone: 1-519-595-4444 - Toll Free: 1-800-561-3164
Fax: 1-519-595-4380 - www.boshart.com

SEAL WELL PLASTIC WELL SEALS

- Allows for larger conduit cables and will have a consistent design for the entire line.
- Heavy duty construction, made from UV stabilized ABS material c/w soft 3/4" thick Buna N rubber gasket and zinc plated hardware.
- All seals complete with grommet kit which have both round and slotted gaskets for twisted or parallel pump cables, produced from very soft rubber which compresses easily when the conduit bushing is tightened.
- Option for a split well seals & stainless steel hardware available in all sizes
- To order split well seals, please add the letter S to the Part No.
Example: To order the split version of WSP40, please order as WSP40S. Please contact your Sales Rep for pricing.
- To order seals with SS hardware, please add the letters -SH to the end of Part No.
Example: For Part No. WSP4010, order as WSP4010-SH or WSP4010S-SH (split c/w SS bolts).



Please contact your Sales Rep for pricing.

PLASTIC SUBMERSIBLE PUMP WELL SEALS - SINGLE HOLE

PART NO	WELL CASING I.D.	DROP PIPE SIZE	VENT SIZE	CONDUIT SIZE	WGT lbs	QTY CASE	LIST PRICE-A
WSP4010	4"	1"	1/2"	3/4"	1.476	16	25.44
WSP4012	4"	1-1/4"	1/2"	3/4"	1.402	16	25.23
WSP4015	4"	1-1/2"	1/2"	3/4"	1.375	16	25.21
WSP4020 *	4"	2"	1/2"	3/4"	1.126	16	23.51
WSP4210	4-1/4"	1"	1/2"	3/4"	1.506	16	25.99
WSP4212	4-1/4"	1-1/4"	1/2"	3/4"	1.440	16	25.80
WSP4215	4-1/4"	1-1/2"	1/2"	3/4"	1.405	16	25.76
WSP4220	4-1/4"	2"	1/2"	3/4"	1.156	16	24.02
WSP5010	5"	1"	1/2"	1"	2.154	8	32.02
WSP5012	5"	1-1/4"	1/2"	1"	2.098	8	32.15
WSP5015	5"	1-1/2"	1/2"	1"	2.028	8	32.05
WSP5020	5"	2"	1/2"	1"	1.898	8	31.74
WSP5210	5-1/4"	1"	1/2"	1"	2.200	8	32.84
WSP5212	5-1/4"	1-1/4"	1/2"	1"	2.144	8	POR
WSP5215	5-1/4"	1-1/2"	1/2"	1"	2.074	8	POR
WSP5220	5-1/4"	2"	1/2"	1"	1.944	8	POR
WSP6010	6"	1"	1/2"	1"	2.788	8	36.25
WSP6012	6"	1-1/4"	1/2"	1"	2.690	8	36.18
WSP6015	6"	1-1/2"	1/2"	1"	2.688	8	36.03
WSP6020	6"	2"	1/2"	1"	2.484	8	35.64
WSP6210	6-1/4"	1"	1/2"	1"	2.854	8	36.78
WSP6212	6-1/4"	1-1/4"	1/2"	1"	2.756	8	36.72
WSP6215	6-1/4"	1-1/2"	1/2"	1"	2.754	8	36.58
WSP6220	6-1/4"	2"	1/2"	1"	2.550	8	36.19



* Note: The 4" x 2" well seals have raised supports which the drop pipe fitting rests on, this keeps the fittings above the nuts and conduit bushing making it possible to incorporate a 3/4" cable hole which is larger than any other 4" x 2" on the market.

PLASTIC JET PUMP WELL SEALS - DOUBLE HOLE

PART NO	WELL CASING I.D.	DROP PIPE SIZE	VENT SIZE	CONDUIT SIZE	WGT lbs	QTY CASE	LIST PRICE-A
WSP401210	4"	1-1/4" x 1"	1/2"	-	1.292	16	23.33
WSP421210	4-1/4"	1-1/4" x 1"	1/2"	-	1.322	16	23.87
WSP501210	5"	1-1/4" x 1"	1/2"	-	1.988	8	30.23
WSP521210	5-1/4"	1-1/4" x 1"	1/2"	-	2.034	8	POR
WSP601210	6"	1-1/4" x 1"	1/2"	-	2.716	8	34.13
WSP601212	6"	1-1/4" x 1-1/4"	1/2"	-	2.372	8	33.98
WSP621210	6-1/4"	1-1/4" x 1"	1/2"	-	2.782	8	34.68
WSP621212	6-1/4"	1-1/4" x 1-1/4"	1/2"	-	2.438	8	34.54



PLASTIC WELL SEALS - BLANK

PART NO	WELL CASING I.D.	DROP PIPE SIZE	VENT SIZE	CONDUIT SIZE	WGT lbs	QTY CASE	LIST PRICE-A
WSP40	4"	Blank	1/2"	3/4" (W/Plug)	1.566	16	25.54
WSP42	4-1/4"	Blank	1/2"	3/4" (W/Plug)	1.596	16	26.09
WSP50	5"	Blank	1/2"	1" (W/Plug)	2.230	8	32.35
WSP52	5-1/4"	Blank	1/2"	1" (W/Plug)	2.276	8	33.18
WSP60	6"	Blank	1/2"	1" (W/Plug)	2.886	8	36.31
WSP62	6-1/4"	Blank	1/2"	1" (W/Plug)	2.952	8	36.87



BOSHART INDUSTRIES

Telephone: 1-519-595-4444 - Toll Free: 1-800-561-3164

Fax: 1-519-595-4380 - www.boshart.com

11-13
April 27/20

CAST IRON WELL SEAL - SINGLE DROP PIPE - SUBMERSIBLE PUMP

PART NO	GROMMET KIT INCLUDED	WELL CASING I.D.	DROP PIPE SIZE	VENT SIZE	CONDUIT SIZE	WGT lbs	QTY CASE	LIST PRICE-A
WS2010		2"	1"	-	-	1	1	105.81
WS2012	Yes	2"	1-1/4"	-	-	1	1	99.83
WS3010	Yes	3"	1"	1/8"	3/8"	2	1	82.23
WS3012	Yes	3"	1-1/4"	3/8"	3/8"	2	1	82.23
WS4010	Yes	4"	1"	1/2"	3/4"	3-1/4	1	50.78
WS4012	Yes	4"	1-1/4"	1/2"	3/4"	3	1	50.78
WS4015	Yes	4"	1-1/2"	1/2"	3/4"	2-3/4	1	69.82
WS4020	Yes	4"	2"	1/2"	3/4"	2-1/2	1	69.82
WS4210	Yes	4-1/4"	1"	1/2"	3/4"	3-1/4	1	68.11
WS4212	Yes	4-1/4"	1-1/4"	1/4"	3/4"	3	1	68.11
WS4510	Yes	4-1/2"	1"	1/2"	1/2"	5	6	69.11
WS4512	Yes	4-1/2"	1-1/4"	1/2"	1/2"	5	6	67.26
WS5010	Yes	5"	1"	1/2"	1"	5-1/2	1	102.95
WS5012	Yes	5"	1-1/4"	1/2"	1"	5-1/4	1	104.31
WS5015	Yes	5"	1-1/2"	1/2"	1"	5	6	70.96
WS5020	Yes	5"	2"	1/2"	1"	4-1/2	1	104.31
WS5510	Yes	5-5/8"	1"	1/2"	3/4"	7	1	118.40
WS5512	Yes	5-5/8"	1-1/4"	1/2"	3/4"	7	1	134.17
WS6010	Yes	6"	1"	1/2"	1"	8-1/4	1	82.76
WS6012	Yes	6"	1-1/4"	1/2"	1"	9	1	91.62
WS6015	Yes	6"	1-1/2"	1/2"	1"	7	1	120.54
WS6020	Yes	6"	2"	1/2"	1"	7-1/4	1	120.54
WS6030 *	Yes	6"	3"	1/2"	1"	6	1	140.96
WS6210	Yes	6-1/4"	1"	1/2"	1"	8-1/2	1	82.76
WS6212	Yes	6-1/4"	1-1/4"	1/2"	1"	8	1	91.62
WS6215	Yes	6-1/4"	1-1/2"	1/2"	1"	7	1	206.65
WS6220	Yes	6-1/4"	2"	1/2"	1"	7-1/2	1	120.54



Clamp-Over Style Well Seal

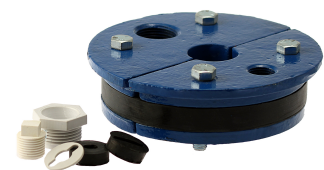

Well Seal Modification available, please call for price and delivery

* Seal is Solid Plate

CAST IRON BLANK WELL SEALS

PART NO	GROMMET KIT INCLUDED	WELL CASING I.D.	VENT SIZE	CONDUIT SIZE	LIST PRICE-A
WS40 *	No	4"			95.41
WS50	Yes	5"	1/2"	1"	100.47
WS60 *	Yes	6"	1/2"	1"	114.97
WS62 *	Yes	6-1/4"	1/2"	1"	114.97

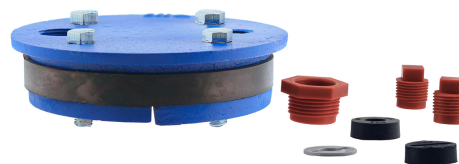

* Seal is solid plate

BOSHART INDUSTRIES

11-14
April 27/20

Telephone: 1-519-595-4444 - Toll Free: 1-800-561-3164
Fax: 1-519-595-4380 - www.boshart.com

CAST IRON/STEEL WELL SEAL - DOUBLE HOLE - JET PUMP

PART NO	GROMMET KIT INCLUDED	WELL CASING I.D.	DROP PIPE SIZE	VENT SIZE	WGT lbs	QTY CASE	LIST PRICE-A
WS301007	No	3"	1" x 3/4"	1/4"	2	1	80.68
WSS351210 *	No	3-1/2"	1-1/4" x 1"	1/2"	3	1	84.17
WSS401010 *	No	4"	1" x 1"	1/2"	4	1	159.55
WS401210	No	4"	1-1/4" x 1"	1/2"	2-3/4	1	56.64
WS401212	No	4"	1-1/4" x 1-1/4"	1/2"	4	1	75.97
WS421210	No	4-1/4"	1-1/4" x 1"	1/2"	2-3/4	1	67.09
WS451210	No	4-1/2"	1-1/4" x 1"	1/2"	5	1	602.80
WS501210	No	5"	1-1/4" x 1"	1/2"	5	1	102.43
WSS501212 *	No	5"	1-1/4" x 1-1/4"	1/2"	6	1	159.44
WS551210	No	5-5/8"	1-1/4" x 1"	1/2"	7	6	94.26
WS601210	No	6"	1-1/4" x 1"	1/2"	7-3/4	1	94.19
WS601212	No	6"	1-1/4" x 1-1/4"	1/2"	7-1/2	1	115.15
WSS601512 *	No	6"	1-1/2" x 1-1/4"	1/2"	9	1	130.94
WS621210	No	6-1/4"	1-1/4" x 1"	1/2"	8	1	94.19
WS621212	No	6-1/4"	1-1/4" x 1-1/4"	1/2"	8	1	115.15
WSS621512 *	No	6-1/4"	1-1/2" x 1-1/4"	1/2"	9	1	165.77



Well Seal Modification available, please call for price and delivery
* Seal is manufactured from steel plate - solid top plate design

GROMMET KITS

PART NO	DESCRIPTION	LIST PRICE-A
WS-GK-07	3/4" Wire hole grommet kit	4.74
WS-GK-10	1" Wire hole grommet kit	4.83



PVC WELL SEAL AIR VENT

- Eight 0.04" slits, four on each side

PART NO	DESCRIPTION	QUANTITY CTN	LIST PRICE-A
WS-V05	1/2" MPT x 5" Length	500	5.78



ZINC PLATED STEEL AIR VENT

- Fabricated from 1/2" zinc steel pipe
- 40 Mesh Stainless Steel vermin proof screen included
- Use for water well ventilation
- Approximate overall dimensions: Height= 12-7/8" x Width= 7-3/4"



PART NO.	SIZE	QTY	LIST PRICE-A
WS-V05-G	1/2"		19.89

BOSHART INDUSTRIES

Telephone: 1-519-595-4444 - Toll Free: 1-800-561-3164

Fax: 1-519-595-4380 - www.boshart.com

11-15

April 27/20

BII™ STEEL SANITARY WELL SEALS

- Single drop pipe hole (submersible pump seal)
- Solid, high strength steel top & bottom plates made from A36 hot rolled steel
- Steel plates are powder coated for durable finish
- Soft extra thick 1" rubber gaskets for positive sealing
- Zinc plated steel bolts • Individually boxed
- Large pump cable / wire holes for easy installation
- For the Eye Bolt option, add -EB to the end of the part no. Please contact your Sales Rep for pricing.



PART NO.	NOMINAL SIZE	GASKET O.D.	FITS CASING I.D.	DROP PIPE SIZE	VENT SIZE	CONDUIT SIZE-FPT	TOP PLATE	MAX LOAD	QUANTITY CTN	WEIGHT EACH-LBS	LIST PRICE-A
WSS3510	3-1/2"	3.51"	3-1/2"	1"	1/2"	1/2"	1/2"		16	3.00	91.66
WSS4010	4"	3.95"	4" - 4-1/4"	1"	1/2"	3/4"	3/16	2100	12	2.00	47.80
WSS4012	4"	3.95"	4" - 4-1/4"	1-1/4"	1/2"	3/4"	3/16	2100	12	2.00	57.48
WSS4015	4"	3.95"	4" - 4-1/4"	1-1/2"	1/2"	3/4"	3/16	2100	12	2.00	57.48
WSS4020 *	4"	3.95"	4" - 4-1/4"	2"	1/2"	3/4"	3/16	2100	12	2.00	74.21
WSS4510	4-1/2"	4.20"	4-1/4" - 4-1/2"	1"	1/2"	3/4"	3/16	2100	6	2.2	121.98
WSS4512	4-1/2"	4.20"	4-1/4" - 4-1/2"	1-1/4"	1/2"	3/4"	3/16	2100	6	2.0	121.98
WSS4515	4-1/2"	4.20"	4-1/4" - 4-1/2"	1-1/2"	1/2"	3/4"	3/16	2100	6	1.9	121.98
WSS4520	4-1/2"	4.20"	4-1/4" - 4-1/2"	2"	1/2"	1/2"	3/16	2100	6	1.8	148.10
WSS5010	5"	4.95"	5" - 5-1/4"	1"	1/2"	1"	3/16	1500	12	2.75	55.04
WSS5012	5"	4.95"	5" - 5-1/4"	1-1/4"	1/2"	1"	3/16	1500	12	2.75	55.04
WSS5015	5"	4.95"	5" - 5-1/4"	1-1/2"	1/2"	1"	3/16	1500	12	2.75	55.04
WSS5020	5"	4.95"	5" - 5-1/4"	2"	1/2"	1"	3/16	1500	12	2.75	55.04
WSS6010	6"	5.95"	6" - 6-1/4"	1"	1/2"	1"	3/16	1100	8	4.00	69.29
WSS6012	6"	5.95"	6" - 6-1/4"	1-1/4"	1/2"	1"	3/16	1100	8	4.00	69.29
WSS6015	6"	5.95"	6" - 6-1/4"	1-1/2"	1/2"	1"	3/16	1100	8	4.00	69.29
WSS6020	6"	5.95"	6" - 6-1/4"	2"	1/2"	1"	3/16	1100	8	4.00	69.29
WSS6010HD	6"	5.95"	6" - 6-1/4"	1"	1/2"	1"	3/8	9000	8	4.00	109.49
WSS6012HD	6"	5.95"	6" - 6-1/4"	1-1/4"	1/2"	1"	3/8	9000	8	4.00	110.09
WSS6015HD	6"	5.95"	6" - 6-1/4"	1-1/2"	1/2"	1"	3/8	9000	8	4.00	109.70
WSS6020HD	6"	5.95"	6" - 6-1/4"	2"	1/2"	1"	3/8	9000	8	4.00	110.02
WSS6030HD *	6"	5.95"	6" - 6-1/4"	3"			3/8	9000	8	4.00	147.60
WSS6210	6-1/4"	6.20"	6-1/4"	1"	1/2"	1"	3/16	1100	8	4.00	69.29
WSS6212	6-1/4"	6.20"	6-1/4"	1-1/4"	1/2"	1"	3/16	1100	8	4.00	69.29
WSS6215	6-1/4"	6.20"	6-1/4"	1-1/2"	1/2"	1"	3/16	1100	8	4.00	69.29
WSS6220	6-1/4"	6.20"	6-1/4"	2"	1/2"	1"	3/16	1100	8	4.00	69.29
WSS7010	7"	6.585"	7"	1"	1/2"	1-1/4"	3/8	2000	6	6.00	143.24
WSS7012	7"	6.585"	7"	1-1/4"	1/2"	1-1/4"	3/8	2000	6	6.00	143.11
WSS7015	7"	6.585"	7"	1-1/2"	1/2"	1-1/4"	3/8	9000	6	7.00	143.11
WSS7020	7"	6.585"	7"	2"	1/2"	1-1/4"	3/8	9000	6	7.00	142.85
WSS7030	7"	6.585"	7"	3"	1/2"	1-1/4"	3/8	9000	6	7.00	144.30
WSS8010	8"	7.95"	8" - 8-1/4"	1"	1/2"	1-1/4"	3/8	6900	4	7.25	142.07
WSS8012	8"	7.95"	8" - 8-1/4"	1-1/4"	1/2"	1-1/4"	3/8	6900	4	7.25	142.07
WSS8015	8"	7.95"	8" - 8-1/4"	1-1/2"	1/2"	1-1/4"	3/8	6900	4	7.25	141.99
WSS8020	8"	7.95"	8" - 8-1/4"	2"	1/2"	1-1/4"	3/8	6900	4	7.25	141.86
WSS8025	8"	7.95"	8" - 8-1/4"	2-1/2"	1/2"	1-1/4"	3/8	6900	4	7.25	173.64
WSS8030	8"	7.95"	8" - 8-1/4"	3"	1/2"	1-1/4"	1/2	12000	4	7.25	212.33
WSS8040	8"	7.95"	8" - 8-1/4"	4"	1/2"	1-1/4"	5/8	27000	4	7.25	252.61
WSS10010	10"	9.95"	10"	1"	1/2"	1-1/4"	3/8	2800	3	17.00	256.56
WSS10012	10"	9.95"	10"	1-1/4"	1/2"	1-1/4"	3/8	2800	3	17.00	256.83
WSS10015	10"	9.95"	10"	1-1/2"	1/2"	1-1/4"	3/8	2800	3	17.00	257.95
WSS10020	10"	9.95"	10"	2"	1/2"	1-1/4"	3/8	2800	3	17.00	252.08
WSS10025	10"	9.95"	10"	2-1/2"	1/2"	1-1/4"	5/8	16500		17.00	439.45
WSS10030	10"	9.95"	10"	3"	1/2"	1-1/4"	5/8	16500	3	17.00	361.38
WSS10040	10"	9.95"	10"	4"	1/2"	1-1/4"	5/8	16500	3	17.00	354.33
WSS10050	10"	9.95"	10"	5"	1/2"	1"	3/4	34000	3	17.00	312.53
WSS10060	10"	9.95"	10"	6"	1/2"	1"	3/4	34000	3	17.00	370.08
WSS12012	12"	11.95"	12"	1-1/4"	1/2"	1-1/4"	3/8	2800	2	26.00	318.07
WSS12015	12"	11.95"	12"	1-1/2"	1/2"	1-1/4"	3/8	2800	2	26.00	318.35
WSS12020	12"	11.95"	12"	2"	1/2"	1-1/4"	1/2	6600	2	26.00	368.04
WSS12030	12"	11.95"	12"	3"	1/2"	1-1/4"	5/8	12000	2	26.00	442.46
WSS12040	12"	11.95"	12"	4"	1/2"	1-1/4"	5/8	12000	2	26.00	443.19
WSS12050	12"	11.95"	12"	5"	1/2"	1-1/4"	3/4	22000	2	26.00	453.21
WSS12060	12"	11.95"	12"	6"	1/2"	1-1/4"	3/4	22000	2	26.00	453.40

* **Note:** The 4" x 2" and 6" x 3" HD well seals have raised supports which the drop pipe fitting rests on. This keeps the fittings above the nuts and conduit bushing, making it possible to incorporate a 3/4" cable hole on the 4" x 2" and 1" cable hole on the 6" x 3" which is larger than the others on the market.

BOSHART INDUSTRIES

Telephone: 1-519-595-4444 - Toll Free: 1-800-561-3164

Fax: 1-519-595-4380 - www.boshart.com

11-16

April 27/20