

TEDDICO
ELECTRICAL PRODUCTS

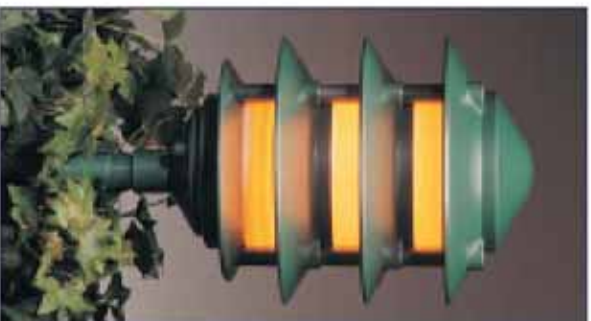

**Weatherproof
Electrical
Products**



www.teddicobwf.com

CORPORATE STATEMENT

As Manufacturers of Outdoor Weatherproof Electrical Products, it is BWF/M. Stephens' goal to provide our Customers with quality products at competitive prices - backed by the highest level of commitment and service available in this industry.

We provide a broad range of electrical fittings and weatherproof products to the market, and are committed to total Customer satisfaction by meeting or exceeding expectations for quality, on-time delivery, and friendly, knowledgeable Customer service.

The vision of M. Stephens is to achieve this by being more responsive, more flexible, faster, easier and more profitable to do business with than our competitors. Every element of our on-going business strategies will be aimed at accomplishing this vision.



Weatherproof Electrical Products



Outlet Boxes

1



Covers

2



Lampholders and
Accessories

3



Garden Lighting

4



Vaportight

5



Conduit Bodies

6



Service Entrance Heads,
Electrical Fittings,
Replacement Parts & Accessories

7

For over 50 years, BWF/M. Stephens has been a leader in the die casting industry. With the full line of outdoor weatherproof products, BWF/M. Stephens is committed to offering the high quality and customer service expected from the BWF/M. Stephens name.

ONE GANG WEATHERPROOF OUTLET BOXES - DIE CAST METAL

BWF Product Benefits & Features

- Rugged, seamless, die-cast construction that prevents moisture entry
- Reinforced connector outlets provide a secure mechanical installation
- State of the art powder coat finish for maximum durability
- Closure plugs, ground screw and mounting lugs included
- Complete installation instructions included with each product

Applications

- For use in branch circuit wiring in wet, damp or dry locations
- May be used as a weatherproof junction box, or as a housing for receptacles, switches and GFCI's

One Gang Outlet Box with 3 Threaded Outlets

4 9/16" x 2 13/16" x 2", closure plugs, ground screw and mounting lugs included

BWF#	Unit UPC	Unit Cubic	Outlets	Description	Color	Case Qty.	Case Weight
Show Pak							
B-5V	18021-6	18.3"	3-1/2"	Grey	20	11.6	
B-5AV	18520-4	18.3"	3-1/2"	Bronze	20	11.6	
B-5WV	18720-8	18.3"	3-1/2"	White	20	11.6	
B-75V	18031-5	18.3"	3-3/4"	Grey	20	11.4	
B-75AV	52886-5	18.3"	3-3/4"	Bronze	20	11.4	
B-75WV	52885-8	18.3"	3-3/4"	White	20	11.4	
B-100V	27100-6	18.3"	3-1"	Grey	20	11.2	
Blister Carded							
1503-1	01503-7	97.3"	3-1/2"	Grey	6	3.9	
1503AB-1	18523-5	97.3"	3-1/2"	Bronze	6	3.9	
1503W-1	50000-7	97.3"	3-1/2"	White	6	3.9	
1753-1	01753-6	97.3"	3-3/4"	Grey	6	3.9	
1753AB-1	18533-4	97.3"	3-3/4"	Bronze	6	3.9	
1753W-1	50005-2	97.3"	3-3/4"	White	6	3.9	

Deep, One Gang Outlet Box with 3 Threaded Outlets

4 9/16" x 2 13/16" x 2 5/8", closure plugs, ground screw and mounting lugs included

BWF#	Unit UPC	Unit Cubic	Outlets	Description	Color	Case Qty.	Case Weight
Show Pak							
DB-5V	38006-7	23.8	3-1/2"	Grey	12	10	
DB-75V	27105-1	23.8	3-3/4"	Grey	12	10	
DB-100V	27108-2	23.8	3-1"	Grey	12	10	

One Gang Outlet Box with 4 Threaded Outlets

4 9/16" x 2 13/16" x 2", closure plugs, ground screw and mounting lugs included

BWF#	Unit UPC	Unit Cubic	Outlets	Description	Color	Case Qty.	Case Weight
Show Pak							
B5-2V	18041-4	18.3"	4-1/2"	Grey	20	12.1	
B5-2AV	27111-2	18.3"	4-1/2"	Bronze	20	12.1	
B5-2WV	18044-5	18.3"	4-1/2"	White	20	12.1	
B75-2V	18051-3	18.3"	4-3/4"	Grey	20	12.1	
B75-2AV	27113-6	18.3"	4-3/4"	Bronze	20	12.1	
B75-2WV	27114-3	18.3"	4-3/4"	White	20	12.1	
Blister Carded							
1504-1	01504-4	97.3"	4-1/2"	Grey	6	4.0	
1504AB-1	18543-3	97.3"	4-1/2"	Bronze	6	4.0	
1504W-1	50010-6	97.3"	4-1/2"	White	6	4.0	
1754-1	01754-3	97.3"	4-3/4"	Grey	6	4.0	



B5-2V



One Gang Outlet Box with 5 Threaded Outlets

4 9/16" x 2 13/16" x 2", closure plugs, ground screw and mounting lugs included

BWF#	Unit UPC	Unit Cubic	Outlets	Description	Color	Case Qty.	Case Weight
Show Pak							
B5-22V	18061-2	18.3"	5-1/2"	Grey	20	12	
B5-22AV	27115-0	18.3"	5-1/2"	Bronze	20	12	
B5-22WV	27116-7	18.3"	5-1/2"	White	20	12	
B75-22V	18071-1	18.3"	5-3/4"	Bronze	20	11.4	
B75-22AV	27117-4	18.3"	5-3/4"	White	20	11.4	
B75-22WV	27118-1	18.3"	5-3/4"	White	20	11.4	
B5-22XV	18081-0	18.3"	5-1/2" X	Grey	20	12	
B75-22XV	27121-1	18.3"	5-3/4" X	Grey	20	12	
B100-22XV	27124-2	18.3"	5-1" X	Grey	20	12	



B5-22V

Deep, One Gang Outlet Box with 5 Threaded Outlets

4 9/16" x 2 13/16" x 2 5/8", closure plugs, ground screw and mounting lugs included

BWF#	Unit UPC	Unit Cubic	Outlets	Description	Color	Case Qty.	Case Weight
Show Pak							
DB-5-22XV	27127-3	23.8	5-1/2" X	Grey	12	10	
DB-75-22XV	27130-3	23.8	5-3/4" X	Grey	12	10	
DB-100-22XV	27133-4	23.8	5-1" X	Grey	12	10	



X-Type

TWO GANG WEATHERPROOF OUTLET BOXES – DIE CAST METAL

BWF Product Benefits & Features

- Rugged, seamless, die-cast construction that prevents moisture entry
- Reinforced connector outlets provide a secure mechanical installation
- State of the art powder coat finish for maximum durability
- Closure plugs, ground screw and mounting lugs included
- Complete installation instructions included with each product

Applications

- For use in branch circuit wiring in wet, damp or dry locations
- May be used as a weatherproof junction box, or as a housing for receptacles, switches and GFCIs



DB-5-22XV

Two Gang Outlet Box with 3 Threaded Outlets

4 9/16" x 4 5/8" x 2", closure plugs, ground screw and mounting lugs included

BWF#	Unit UPC	Unit Cubic	Outlets	Description	Color	Case Qty.	Case Weight
Show Pak							
TGB-5V	19000-0	30.5"	3-1/2"	Grey	12	13	
TGB-75V	19016-1	30.5"	3-3/4"	Grey	12	13	
TGB-100V	27147-1	30.5"	3-1"	Grey	12	13	
TGB-100AV	27148-8	30.5"	3-1"	Bronze	12	13	
TGB-100WV	27149-5	30.5"	3-1"	White	12	13	
Bliester Carded							
2503-1	02503-6	117.3"	3-1/2"	Grey	6	8	
2503AB-1	19508-1	117.3"	3-1/2"	Bronze	6	8	



TGB-5V





TWO GANG WEATHERPROOF OUTLET BOXES – DIE CAST METAL

Two Gang Outlet Box with 4 Threaded Outlets

4-9 / 16" x 4-5 / 8" x 2", closure plugs, ground screw and mounting lugs included

BWF#	Unit UPC 0-87115	Unit Cubic	Outlets	Description	Color	Case Qty.	Case Weight
Show Pak							
TGB-54V	19026-0	30.5"	4-1/2"	Grey	Grey	12	13
TGB75-4V	27152-5	30.5"	4-3/4"	Grey	Grey	12	13
Blister Carded							
2504-1	02504-3	117.3"	4-1/2"	Grey	Grey	6	7
2504AB-1	19527-2	117.3"	4-1/2"	Bronze	Bronze	6	7
2504W-1	50025-0	117.3"	4-1/2"	White	White	6	7

Two Gang Outlet Box with 5 Threaded Outlets

4-9 / 16" x 4-5 / 8" x 2", closure plugs, ground screw and mounting lugs included

BWF#	Unit UPC 0-87115	Unit Cubic	Outlets	Description	Color	Case Qty.	Case Weight
Show Pak							
TGB-55V	19047-5	30.5"	5-1/2"	Grey	Grey	12	13
TGB75-5V	19056-7	30.5"	5-3/4"	Grey	Grey	12	13
TGB-55XV	27165-5	30.5"	5-1/2" X	Grey	Grey	12	13
TGB75-5XV	27168-6	30.5"	5-3/4" X	Grey	Grey	12	13
TGB100-5XV	27171-6	30.5"	5-1" X	Grey	Grey	12	13

Deep, Two Gang Outlet Box with 5 Threaded Outlets

4-9 / 16" x 4-5 / 8" x 2-5 / 8", closure plugs, ground screw and mounting lugs included

BWF#	Unit UPC 0-87115	Unit Cubic	Outlets	Description	Color	Case Qty.	Case Weight
DTB-5V	38028-9	40.3	5-1/2"	Grey	Grey	6	7
DTB-75V	27183-9	40.3	5-3/4"	Grey	Grey	6	7
DTB-100V	27186-0	40.3	5-1"	Grey	Grey	6	7

Two Gang Outlet Box with 6 "X" Type Threaded Outlets

4-9 / 16" x 4-5 / 8" x 2", closure plugs, ground screw and mounting lugs included

BWF#	Unit UPC 0-87115	Unit Cubic	Outlets	Description	Color	Case Qty.	Case Weight
Show Pak							
TGB-56XV	27174-7	30.5"	6-1/2" X	Grey	Grey	12	13
TGB75-6XV	27177-8	30.5"	6-3/4" X	Grey	Grey	12	13

Two Gang Outlet Box with 7 Threaded Outlets

4-9 / 16" x 4-5 / 8" x 2", closure plugs, ground screw and mounting lugs included

BWF#	Unit UPC 0-87115	Unit Cubic	Outlets	Description	Color	Case Qty.	Case Weight
Show Pak							
TGB-57V	27159-4	30.5	7-1/2"	Grey	Grey	12	13
TGB-77V	27162-4	30.5	7-3/4"	Grey	Grey	12	13

Two Gang Outlet Box with 7 "X" Type Threaded Outlets

STD: 4-9 / 16" x 4-5 / 8" x 2",

DEEP: 4-9 / 16" x 4-5 / 8" x 2-5 / 8", closure plugs, ground screw & mounting lugs included

BWF#	Unit UPC 0-87115	Unit Cubic	Outlets	Description	Color	Case Qty.	Case Weight
Show Pak							
TGB-57XV	27178-5	30.5	7-1/2" X	Grey	Grey	12	13
TGB-77XV	27179-2	30.5	7-3/4" X	Grey	Grey	12	13
DTB75-7XV	27192-1	40.3	7-3/4" X, Deep	Grey	Grey	6	7
DTB100-7XV	27195-2	40.3	7-1" X, Deep	Grey	Grey	6	7



TGB-54V



DTB-5V



DTB-75V



**TGB-56XV
"X" TYPE**



DTB-75-7XV



ROUND WEATHERPROOF OUTLET BOXES – DIE CAST METAL

BWF Product Benefits & Features

- Rugged, seamless, die-cast construction that prevents moisture entry
- Reinforced connector outlets provide a secure mechanical installation
- State of the art powder coat finish for maximum durability
- Closure plugs, ground screw and mounting lugs included
- Complete installation instructions included with each product

Applications

- For use in branch circuit wiring in wet, damp or dry locations
- May be used as a weatherproof junction box, or as a housing for receptacles, switches and GFCIs

Round Outlet Box with 5 Threaded Outlets

4-9 / 16" x 4-5 / 8" x 2", closure plugs, ground screw and mounting lugs included

BWF#	Unit UPC 0-87115	Unit Cubic	Outlets	Description	Color	Case Qty.	Case Weight
Show Pak							
RB-5V	2006-2	16.5	5-1/2"	Grey	16	12	
RB-5AV	20565-0	16.5	5-1/2"	Bronze	16	12	
RB-5WV	20765-4	16.5	5-1/2"	White	16	12	
RB-7V	27200-3 1	6.5	5-3/4"	Grey	16	12	
Blister Carded							
3505-1	03505-9	117.3	5-1/2"	Grey	6	5	
3505AB-1	20568-1	117.3	5-1/2"	Bronze	6	5	
3505W-1	50030-4	117.3	5-1/2"	White	6	5	



RB-5CGV



RB-5V



Round Outlet Box with 5 Threaded Outlets

4-9 / 16" x 4-5 / 8" x 2", cover, screws, closure plugs, ground screw, gasket & mounting lugs included

BWF#	Unit UPC 0-87115	Unit Cubic	Outlets	Description	Color	Case Qty.	Case Weight
Show Pak							
RB-5CGV	27208-9	16.5	5-1/2"	Grey	16	12	
RB-7GV	27211-9	16.5	5-3/4"	Grey	16	12	

EXTENSIONS & EXTENSION ADAPTERS – DIE CAST METAL

One Gang Box Extension

4-9 / 16" x 2-13 / 16" x 1", gasket & mounting screws included

BWF#	Unit UPC 0-87115	Unit Cubic	Outlets	Description	Color	Case Qty.	Case Weight
Show Pak							
EXR-1V	35007-7	10	1"	Grey	24	7	
EXR-1WV	2737-2	10	1"	White	24	7	
Blister Carded							
10XR-1	01013-1	65	1"	Grey	6	2	
10XRAB-1	35503-4	65	1"	Bronze	6	2	
10XRW-1	50165-3	65	1"	White	6	2	



EXR-1V



One Gang Box Extension Adapter – Flanged

5-1 / 4" x 3-1 / 2" x 1-1 / 2", closure plugs, mounting screws & gasket included

BWF#	Unit UPC 0-87115	Unit Cubic	Outlets	Description	Color	Case Qty.	Case Weight
Show Pak							
EXF5-2V	35011-4	13.3	4-1/2"	Grey	12	7	
EXF75-2V	27140-2	13.3	4-3/4"	Grey	12	8	
EXF75-2WV	27142-6	13.3	4-3/4"	White	12	8	
Blister Carded							
10XF-1	01011-7	76	4-1/2"	Grey	6	4	
10XFAB-1	35513-3	76	4-1/2"	Bronze	6	4	
10XFW-1	50170-7	76	4-1/2"	White	6	4	

EXF5-2V



EXR-2V

EXTENSIONS & EXTENSION ADAPTERS – DIE CAST METAL

Two Gang Outlet Box Extension

4-9 / 16" x 4-5 / 8" x 1", gasket & mounting screws included

BWF#	Unit UPC 0-87-115	Unit Cubic	Outlets	Description	Color	Case Qty.	Case Weight
EXR-2V	35008-4	16.3	1"		Grey	12	4
EXR-2NV	27198-3	16.3	1"		Bronze	12	4

Round Outlet Box Extension with 4 Threaded Outlets

4-9 / 16" x 4-5 / 8" x 2", closure plugs, mounting screws & gasket included

BWF#	Unit UPC 0-87-115	Unit Cubic	Outlets	Description	Color	Case Qty.	Case Weight
EX-5V	35030-5	18.3	4-1/2"		Grey	18	10
EX-7V	27205-8	18.3	4-3/4"		Grey	18	10

SWIMMING POOL JUNCTION BOXES – METAL/PLASTIC

Swimming Pool Junction Boxes with 3 Threaded Outlets

4-9 / 16" x 4-5 / 8" x 2", gasket included

BWF#	Unit UPC 0-87-115	Unit Cubic	Outlets	Description	Color	Case Qty.	Case Weight
PB-50	26005-5	22	3-1/2"		Brass	10	15
PB-75	34010-8	22	3-3/4"		Brass	10	15
PB-100	34015-3	22	2-3/4"1-1"		Brass	10	15



PB-50

For use with installation of underwater pool lights.

For connecting to 120V or low voltage below normal water level of the pool.

Complies with the latest NEC, UL and CSA standards. Solid brass wiring platform with grounding post and 3 ground terminals - use with metallic or PVC conduit.

NOTE: To achieve watertight installation, reference is made to the 1999 National Electrical Code (NEC) Article 680-20(b)(2) which states "The end of the flexible-cord jacket and the flexible-cord conductor terminals within a fixture shall be covered with, or encapsulated in, a suitable potting compound to prevent the entry of water into the fixture through the cord or its conductors. In addition, the grounding connection within a fixture shall be similarly treated to protect such connection from the deteriorating effect of pool water" in the event of water entry into the fixture." Article 680-21 Exception (a), which states "An approved potting compound is used to fill the box to prevent the entrance of moisture."

OUTSIDE DIMENSIONS

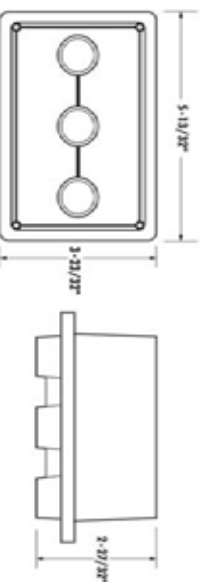

NPE Conduit Hub		A	B	C
BWF#				
PB-50		1/2"	1/2"	1/2"
PB-75		3/4"	3/4"	3/4"
PB-100		3/4"	1"	3/4"

OUTSIDE DIMENSIONS

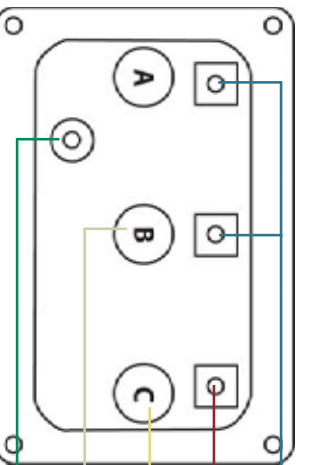

- Grounding Post for flexible cord ground wire
- Grounding Post for attaching grounding conductor from feed wire
- Use Hub "C" for entry of feed wiring
- Use Hub "B" for entry of flexible cord from pool light
- Compression Grounding Post for bonding wire (if required)

ONE GANG BOX & EXTENSION DRAWINGS

Single Gang Boxes – Standard & Deep Dimensions and Cubic Inches

BWF#	Hub Size	A	B	C	D	E	F	G	H	J	Cubic Inches
B-5V	1/2"	4-9/16"	2-13/16"	2"	5/8"	3-3/16"	3-1/2"	3-1/4"	1-7/8"	-	18.3"
B-75V	3/4"	4-9/16"	2-13/16"	2"	5/8"	3-3/16"	3-1/2"	3-1/4"	1-7/8"	-	18.3"
B-100V	1"	4-9/16"	2-13/16"	2"	5/8"	3-3/16"	3-1/2"	3-1/4"	1-7/8"	-	18.3"
DB-5V	1/2"	4-9/16"	2-13/16"	25/8"	3/4"	3-3/16"	3-1/2"	3-1/4"	1-7/8"	-	23.8"
DB-75V	3/4"	4-9/16"	2-13/16"	25/8"	3/4"	3-3/16"	3-1/2"	3-1/4"	1-7/8"	-	23.8"
DB-100V	1"	4-9/16"	2-13/16"	25/8"	3/4"	3-3/16"	3-1/2"	3-1/4"	1-7/8"	-	23.8"
B5-2V	1/2"	4-9/16"	2-13/16"	2"	5/8"	3-3/16"	3-1/2"	3-1/4"	1-7/8"	1-1/2"	18.3"
B5-2V	3/4"	4-9/16"	2-13/16"	2"	5/8"	3-3/16"	3-1/2"	3-1/4"	1-7/8"	1-1/2"	18.3"
B5-22V	1/2"	4-9/16"	2-13/16"	2"	5/8"	3-3/16"	3-1/2"	3-1/4"	1-7/8"	1-1/2"	18.3"
B5-22V	3/4"	4-9/16"	2-13/16"	2"	5/8"	3-3/16"	3-1/2"	3-1/4"	1-7/8"	1-1/2"	18.3"
B5-22XV	1/2"	4-9/16"	2-13/16"	2"	5/8"	3-3/16"	3-1/2"	3-1/4"	1-7/8"	-	18.3"
B5-22XV	3/4"	4-9/16"	2-13/16"	2"	5/8"	3-3/16"	3-1/2"	3-1/4"	1-7/8"	-	18.3"
B100-22XV	1"	4-9/16"	2-13/16"	2"	5/8"	3-3/16"	3-1/2"	3-1/4"	1-7/8"	-	18.3"
DB-5-22XV	1/2"	4-9/16"	2-13/16"	2-5/8"	3/4"	3-3/16"	3-1/2"	3-1/4"	1-7/8"	-	23.8"
DB-75-22XV	3/4"	4-9/16"	2-13/16"	2-5/8"	3/4"	3-3/16"	3-1/2"	3-1/4"	1-7/8"	-	23.8"
DB-100-22XV	1"	4-9/16"	2-13/16"	2-5/8"	3/4"	3-3/16"	3-1/2"	3-1/4"	1-7/8"	-	23.8"

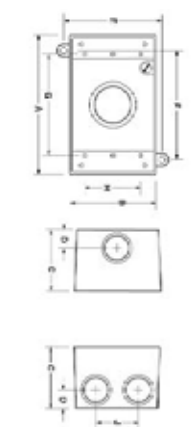

Extensions and Extension Adapters are used to provide additional capacity needed for NEC box fill requirements. Adapters allow installer to add "take-offs" to new boxes and/or devices.

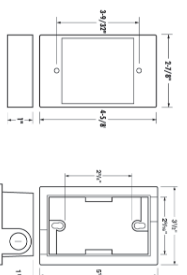

TWO GANG BOX & EXTENSION DRAWINGS

Two Gang Boxes – Standard & Deep Dimensions and Cubic Inches

BWF#	Hub Size	A	B	C	D	E	F	G	H	J	K	L	Cubic Inches
TGB-5V	1/2"	4-9/16"	4-5/8"	2"	5/8"	5"	3-7/8"	3-11/16"	3-3/4"	-	-	3-1/4"	30.5"
TGB-75V	3/4"	4-9/16"	4-5/8"	2"	5/8"	5"	3-7/8"	3-11/16"	3-3/4"	-	-	3-1/4"	30.5"
TGB-100V	1"	4-9/16"	4-5/8"	2"	5/8"	5"	3-7/8"	3-11/16"	3-3/4"	-	-	3-1/4"	30.5"
TGB-54V	1/2"	4-9/16"	4-5/8"	2"	5/8"	5"	3-7/8"	3-11/16"	3-3/4"	1-1/2"	-	3-1/4"	30.5"
TGB-54V	3/4"	4-9/16"	4-5/8"	2"	5/8"	5"	3-7/8"	3-11/16"	3-3/4"	1-1/2"	-	3-1/4"	30.5"
TGB-55V	1/2"	4-9/16"	4-5/8"	2"	5/8"	5"	3-7/8"	3-11/16"	3-3/4"	1-1/2"	-	3-1/4"	30.5"
TGB-55V	3/4"	4-9/16"	4-5/8"	2"	5/8"	5"	3-7/8"	3-11/16"	3-3/4"	1-1/2"	-	3-1/4"	30.5"
TGB-55XV	1/2"	4-9/16"	4-5/8"	2"	5/8"	5"	3-7/8"	3-11/16"	3-3/4"	-	-	3-1/4"	30.5"
TGB-55XV	3/4"	4-9/16"	4-5/8"	2"	5/8"	5"	3-7/8"	3-11/16"	3-3/4"	-	-	3-1/4"	30.5"
TGB100-5XV	1"	4-9/16"	4-5/8"	2"	5/8"	5"	3-7/8"	3-11/16"	3-3/4"	-	-	3-1/4"	30.5"
DTB-5V	1/2"	4-9/16"	4-5/8"	2-5/8"	3/4"	5"	3-7/8"	3-11/16"	3-3/4"	1-1/2"	-	3-1/4"	40.3"
DTB-75V	3/4"	4-9/16"	4-5/8"	2-5/8"	3/4"	5"	3-7/8"	3-11/16"	3-3/4"	1-1/2"	-	3-1/4"	40.3"
DTB-100V	1"	4-9/16"	4-5/8"	2-5/8"	3/4"	5"	3-7/8"	3-11/16"	3-3/4"	1-1/2"	-	3-1/4"	40.3"
TGB-56XV	1/2"	4-9/16"	4-5/8"	2"	5"	3-7/8"	3-11/16"	3-3/4"	1-1/2"	-	3-1/4"	30.5"	
TGB75-6XV	3/4"	4-9/16"	4-5/8"	2"	5"	3-7/8"	3-11/16"	3-3/4"	1-1/2"	-	3-1/4"	30.5"	
TGB-77V	3/4"	4-9/16"	4-5/8"	2"	5"	3-7/8"	3-11/16"	3-3/4"	-	1-1/2"	3-1/4"	40.3"	
DTB-57XV	1/2"	4-9/16"	4-5/8"	2-5/8"	3/4"	5"	3-7/8"	3-11/16"	3-3/4"	1-1/2"	-	3-1/4"	40.3"
DTB75-7XV	3/4"	4-9/16"	4-5/8"	2-5/8"	3/4"	5"	3-7/8"	3-11/16"	3-3/4"	1-1/2"	-	3-1/4"	40.3"
DTB100-7XV	1"	4-9/16"	4-5/8"	2-5/8"	3/4"	5"	3-7/8"	3-11/16"	3-3/4"	1-1/2"	-	3-1/4"	40.3"

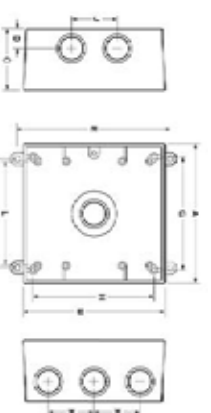

Extensions and Extension Adapters are used to provide additional capacity needed for NEC box fill requirements. Adapters allow installer to add "take-offs" to new boxes and/or devices.

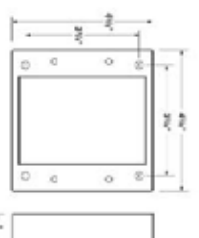

ROUND BOX & EXTENSION DRAWINGS

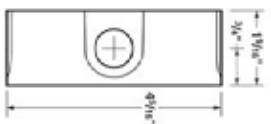
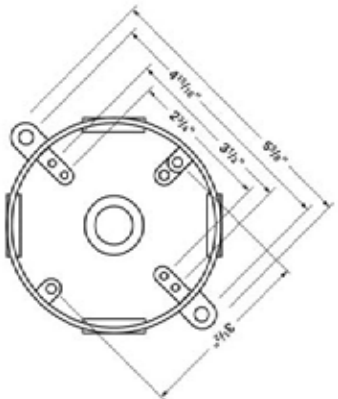

Extensions and Extension Adapters are used to provide additional capacity needed for NEC box fill requirements. Adapters allow installer to add "take-offs" to new boxes and/or devices.

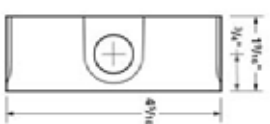
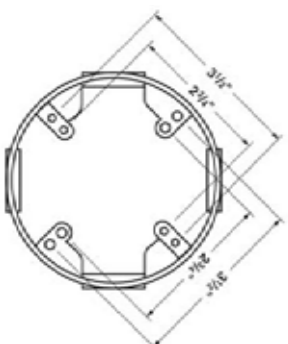

ONE GANG WEATHERPROOF BLANK COVERS – STAMPED STEEL

BWF Product Benefits & Features

- Rugged, seamless construction that prevents moisture entry
- State of the art powder coat finish for maximum durability
- Includes installation hardware, gasket and instructions

Steel One Gang Blank Cover

4 9/16" x 2 13/16", stamped steel cover, gasket & screws included



BWF#	Unit UPC 0-87115	Unit Cubic	Outlets	Description Color	Case Qty.	Case Weight
------	---------------------	---------------	---------	----------------------	--------------	----------------

Show Pak

BC-1V	29005-2	N/A	Blank	Grey	42	4
BC-1W	29505-7	N/A	Blank	Bronze	42	4
BC-1WW	29705-1	N/A	Blank	White	42	4

Blister Carded

711-1	00711-7	17.2	Blank	Grey	12	2
711AB-1	29509-5	17.2	Blank	Bronze	12	2
711W-1	50105-9	17.2	Blank	White	12	2

BC-1V



BC-1XV



Steel One Gang Blank Cover, "X" Type

4 9/16" x 2 13/16", stamped steel cover, gasket & screws included

BWF#	Unit UPC 0-87115	Unit Cubic	Outlets	Description Color	Case Qty.	Case Weight
------	---------------------	---------------	---------	----------------------	--------------	----------------

Show Pak

BC-1XV	27231-7	N/A	Blank X	Grey	42	5
--------	---------	-----	---------	------	----	---

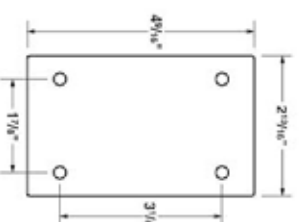
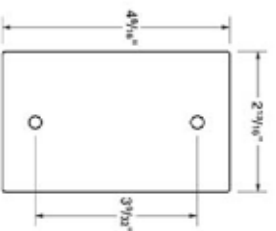

WEATHERPROOF “WHILE-IN-USE” RECEPTACLE COVERS

BWF PRODUCT BENEFITS & FEATURES

- Choose from high-impact polycarbonate construction or heavy duty die cast covers for more severe applications, such as schools and commercial buildings
- Both meet NEC Article 410-57(b). The code requires receptacles be protected in outdoor or other wet locations with the cord set plugged in, unless the receptacle is attended.
- All covers are shipped with gasket, mounting screws, base and cover assembly, two inserts and complete “easy-to-install” instructions.
- Covers may be mounted to a box or device.
- When security is important, there are covers available with a lockable hasp.
- Flexibility in the field: covers combined with one of the 26 rotating, snap-in, inserts will meet any installation requirement.

COMPLIANCES

- UL Listed - CSA Certified
- NEMA 3R rated



APPLICATIONS

- Where weatherproof protection is required while an outlet is in use, such as; bug zappers, holiday lighting, low voltage lighting, soda machines, portable spas, engine block heater, irrigation pond pumps, etc.



MEETS 2002 NEC 406.8(B) (1) Receptacles installed outdoors in a wet location must have an enclosure that is weatherproof when you insert the attachment plug.



HIGH IMPACT CLEAR POLYCARBONATE “WHILE-IN-USE” COVERS

gasket, mounting screws, base & cover assembly, 2 inserts included

PACKAGE TYPE	BWF No.	Unit UPC 0-87115	Description	Depth	Color	Case QTY	Case WT
SHOW PAK	WT1100C*	00100-9	1 gang vertical/horizontal	2 1/4"	Clear	5	3
	WT1100WC*	31175-7	1 gang horizontal/vertical	2 1/4"	Clear	5	3
	WT1150C	00101-6	1 gang vertical/horizontal	4 3/4"	Clear	5	4.25
	WT1220C*	00200-6	2 gang	2 1/4"	Clear	5	8
	WT202Y*	00201-3	2 gang	3 1/8"	Clear	5	8

*With lockable hasp

HEAVY DUTY DIE CAST METAL “WHILE-IN-USE” COVERS

gasket, mounting screws, base & cover assembly, 2 inserts included

PACKAGE TYPE	BWF No.	Unit UPC 0-87115	Description	Depth	Color	Case QTY	Case WT
SHOW PAK	WT1010HMC*	34018-4	1 gang horizontal	3 1/8"	Grey	4	5
	WT100VMV*	34017-7	1 gang vertical	3 1/8"	Grey	4	5
	WT1030MC*	34019-1	2 gang	3 1/8"	Grey	2	3.5

*With lockable hasp



ONE GANG WEATHERPROOF RAISED COVERS – DIE CAST METAL

One Gang Rectangular Lampholder Cover – One 1/2" Hole

4 9/16" x 2 13/16" x 1 1/16", gasket & screws included

BWF#	Unit UPC 0-87115	Unit Cubic	Outlets	Description	Color	Case Qty.	Case Weight
Show Pak							
RC-1V	28036-7	N/A	1-1/2"	1-1/2"	Grey	20	6
RC-1AV	52880-3	N/A	1-1/2"	1-1/2"	Bronze	20	6
RC-1WV	52879-7	N/A	1-1/2"	1-1/2"	White	20	6
Blister Carded							
811-1	00811-4	51.6	1-1/2"	1-1/2"	Grey	12	5
811AB-1	28542-3	51.6	1-1/2"	1-1/2"	Bronze	12	5
811W-1	50095-3	51.6	1-1/2"	1-1/2"	White	12	5



RC-1V

One Gang Rectangular Lampholder Cover – Three 1/2" Holes

4 9/16" x 2 13/16" x 1 1/16", gasket, screws and closure plugs included

BWF#	Unit UPC 0-87115	Unit Cubic	Outlets	Description	Color	Case Qty.	Case Weight
Show Pak							
RC-3V	28056-5	N/A	3-1/2"	3-1/2"	Grey	20	6
RC-3AV	28555-3	N/A	3-1/2"	3-1/2"	Bronze	20	6
RC-3WV	28755-7	N/A	3-1/2"	3-1/2"	White	20	6
Blister Carded							
813-1	00813-8	51.6	3-1/2"	3-1/2"	Grey	12	4
813AB-1	28566-9	51.6	3-1/2"	3-1/2"	Bronze	12	4
813W-1	50100-4	51.6	3-1/2"	3-1/2"	White	12	4



RC-3V

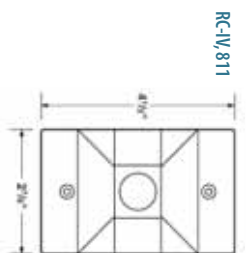

RC-1V,811

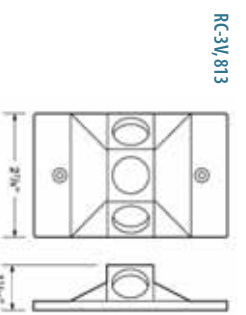

RC-3V,813

One Gang Cover for Horizontal GFCI Devices

Self closing cover, gasket & screws included

BWF#	Unit UPC 0-87115	Unit Cubic	Outlets	Description	Color	Case Qty.	Case Weight
Show Pak							
FG-1DCV	25006-3	N/A	Horiz GFCI	Horiz GFCI	Grey	24	12
FG-1DCAV	25505-1	N/A	Horiz GFCI	Horiz GFCI	Bronze	24	12
FG-1DCWV	25705-5	N/A	Horiz GFCI	Horiz GFCI	White	24	2
Blister Carded							
511H-1	05114-1	43	Horiz GFCI	Horiz GFCI	Grey	6	3
511HAB-1	25508-2	43	Horiz GFCI	Horiz GFCI	Bronze	6	3
511HW-1	50065-6	43	Horiz GFCI	Horiz GFCI	White	6	3



FG-1DCV
CLOSED



OPEN

ONE GANG WEATHERPROOF COVERS – DIE CAST METAL

Horizontal GFCI Kit Includes:

Rectangular 3-hole box, self closing GFCI cover, GFCI receptacle, hardware & instructions

BWF#	Unit UPC 0-871115	Unit Cubic	Outlets	Description	Color	Case Qty.	Case Weight
Clamshell Kit							
GFBK-C-1	41201-0	149		Horiz GFCI Kit	Grey	10	18
GFBKAB-C-1	41202-7	149		Horiz GFCI Kit	Bronze	10	18
GFBKW-C-1	41203-4	149		Horiz GFCI Kit	White	10	18
GFBKB-C-1	41204-1	149		Horiz GFCI Kit	Black	10	18
Display Box Kit							
GFBK	41200-3	130		Horiz GFCI Kit	Grey	10	17
GFBKAB	41205-8	130		Horiz GFCI Kit	Bronze	10	17
GFBKW	50220-9	130		Horiz GFCI Kit	White	10	17
GFBKB	50221-6	130		Horiz GFCI Kit	Black	10	17



GFBK-C

One Gang Cover for Vertical GFCI Devices

Self closing cover, gasket & screws included

BWF#	Unit UPC 0-871115	Unit Cubic	Outlets	Description	Color	Case Qty.	Case Weight
Show Pak							
FGV-IDCV	25012-4	N/A		Vertical GFCI	Grey	24	12
FGV-IDCANV	25510-5	N/A		Vertical GFCI	Bronze	24	12
FGV-IDCWV	25710-9	N/A		Vertical GFCI	White	24	12
Blister Carded							
511V-1	05115-8	43		Vertical GFCI	Grey	6	3
511WB-1	25513-6	43		Vertical GFCI	Bronze	6	3
511WW-1	50070-0	43		Vertical GFCI	White	6	3



FGV-1DC

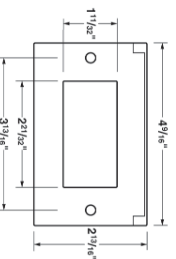

GFCI: Ground Fault Circuit Interrupter or "Shock Protection" outlet stops the flow of electricity at the outlet. Required by the National Electrical Code (NEC) for wet or damp locations, inside or out.

One Gang Vertical Cover for Duplex Receptacles, Switches or Combination Devices

Self closing cover, gasket & screws included

BWF#	Unit UPC 0-871115	Unit Cubic	Outlets	Description	Color	Case Qty.	Case Weight
Show Pak							
FC-61V	22095-0	N/A		Vertical	Grey	24	8
FC-61AV	52884-1	N/A		Vertical	Bronze	24	8
FC-61WV	52883-4	N/A		Vertical	White	24	8



FC-61V



ONE GANG WEATHERPROOF COVERS – DIE CAST METAL

One Gang Vertical Cover for a Single Receptacle or Switch

Self closing cover, gasket & screws included



FC-71V



FCL-71V

BWF#	Unit UPC 0-87115	Unit Cubic	Description Outlets	Color	Case Qty.	Case Weight
Show Pak						
FC-71V	23007-2	N/A	Vertical	Grey	24	8
FC-71AV	27240-9	N/A	Vertical	Bronze	24	8
FC-71WV	27241-6	N/A	Vertical	White	24	8
FCL-71V (Locking)	27255-3	N/A	Vertical	Grey	24	8
SO-71V	27246-1	N/A	Vert Stay Open	Grey	24	8
Blister Carded						
4171-1	04171-5	51.6	Vertical	Grey	6	2
4171AB-1	23508-4	51.6	Vertical	Bronze	6	2
4171W-5-1	0040-3	51.6	Vertical	White	6	2

One Gang Horizontal Cover for a Single Receptacle or Switch

Self closing cover, gasket & screws included



FC-71HV

BWF#	Unit UPC 0-87115	Unit Cubic	Description Outlets	Color	Case Qty.	Case Weight
Show Pak						
FC-71HV	27242-3	N/A	Horizontal	Grey	24	8
FC-71HAV	27243-0	N/A	Horizontal	Bronze	24	8
FC-71HWV	27244-7	N/A	Horizontal	White	24	8

--	--	--	--

ONE GANG WEATHERPROOF COVERS – DIE CAST METAL

One Gang Horizontal Cover for a Duplex Receptacle or Switch

Self closing cover, gasket & screws included

BWF#	Unit UPC 0-87115	Unit Cubic	Outlets	Description	Color	Case Qty.	Case Weight
Show Pak							
FC-81V	23015-7	N/A	Horizontal	Horizontal	Grey	24	10
FC-81AV	23510-7	N/A	Horizontal	Horizontal	Bronze	24	10
FC-81WV	23710-1	N/A	Horizontal	Horizontal	White	24	10
SO-81V	27249-2	N/A	Horiz Stay Open	Horiz Stay Open	Grey	24	9
SO-81AV	27250-8	N/A	Horiz Stay Open	Horiz Stay Open	Bronze	24	9
SO-81WV	27251-5	N/A	Horiz Stay Open	Horiz Stay Open	White	24	9
Blister Carded							
4181-1	04181-4	51.6	Horizontal	Horizontal	Grey	12	5
4181AB-1	23521-3	51.6	Horizontal	Horizontal	Bronze	12	5
4181W-1	50045-8	51.6	Horizontal	Horizontal	White	12	5



FC-81V



FC-81RV



BWF#	Unit UPC 0-87115	Unit Cubic	Outlets	Description	Color	Case Qty.	Case Weight
Show Pak							
FC-81RV	23019-5	N/A	w/Receptacle	w/Receptacle	Grey	18	12
FC-81RAV	27245-4	N/A	w/Receptacle	w/Receptacle	Bronze	18	12
FC-81RWV	23018-8	N/A	w/Receptacle	w/Receptacle	White	18	12
Blister Carded							
4181R-1	41813-5	45	w/Receptacle	w/Receptacle	Grey	6	4
4181RAB-1	23526-8	45	w/Receptacle	w/Receptacle	Bronze	6	4
4181RW-1	50050-2	45	w/Receptacle	w/Receptacle	White	6	4

One Gang Horizontal Cover for a Duplex Receptacle

Self closing cover, receptacle, gasket & screws included

BWF#	Unit UPC 0-87115	Unit Cubic	Cover	Description	Color	Case Qty.	Case Weight
Clamshell Kit							
B81RK-C-1	08137-7	149	Duplex Kit	Duplex Kit	Grey	10	14
B81RKAB-C-1	08138-4	149	Duplex Kit	Duplex Kit	Bronze	10	14
B81RKW-C-1	08139-1	149	Duplex Kit	Duplex Kit	White	10	14
B81RK8-C-1	08140-7	149	Duplex Kit	Duplex Kit	Black	10	14
Display Box Kit							
B81RK	08130-8	130	Duplex Kit	Duplex Kit	Grey	10	14
B81RKAB	08136-0	130	Duplex Kit	Duplex Kit	Bronze	10	14
B81RKW	50210-0	130	Duplex Kit	Duplex Kit	White	10	14
B81RK8	08135-3	130	Duplex Kit	Duplex Kit	Black	10	14

Double Outlet Kit Includes:

Rectangular 3 hole box, self closing duplex cover, duplex receptacle, hardware & instructions



B81RK-C



ONE GANG WEATHERPROOF COVERS – DIE CAST METAL

One Gang Power Outlet Cover for Single Receptacle; 20A, 30A, 50A

Self closing cover, gasket & screws included

BWF#	Unit UPC 0-87115	Unit Cubic	Opening	Description	Color	Case Qty.	Case Weight
Show Pak							
P0-50V	26006-2	20A-50A	2.125"		Grey	24	15
P0-17V	27269-0	30A	1.750"		Grey 2	4	15
P0-16V	27272-0	20A & 30A	1.625"		Grey	24	15
P0-14V	27275-1	STD	1.438"		Grey	24	15



PO-50V

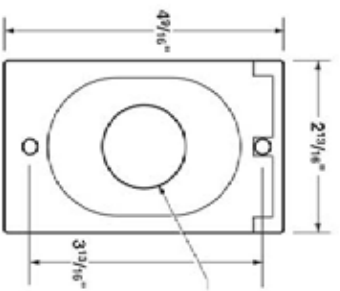

Power Outlet Covers

P0-50V=2.125"D
P0-17V=1.750"D
P0-16V=1.625"D
P0-14V=1.485"D

Dimensional cover drawing for:

FC-81V, 50-81V, 4181, FC-81RV,
4181R, BB1RK-C, BB1RK

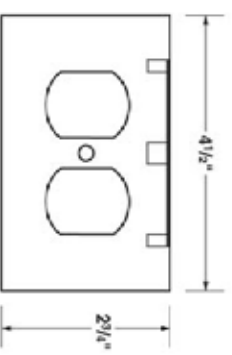

ONE GANG WEATHERPROOF TOGGLE SWITCH COVERS – DIE CAST METAL

One Gang Toggle Switch Cover for One 10A or 20A Switch

Gasket & screws included



TS-1V

FVC-261V

Left & Right Lids Lock

BWF#	Unit UPC 0-87115	Unit Cubic	Switch	Description	Color	Case Qty.	Case Weight
Show Pak							
TS-1V	27281-2	N/A	N/A		Grey	20	5

ONE GANG WEATHERPROOF TOGGLE SWITCH COVERS - DIE CAST METAL

One Gang Toggle Switch Cover with Switch

Gasket & screws included

BWF#	Unit UPC 0-871115	Unit Cubic	Switch	Description	Color	Case Qty.	Case Weight
Show Pak							
TS-11V	27012-2	N/A	15A/single pole	Grey	18	10	
TS-11AV	27284-3	N/A	15A/single pole	Bronze	18	10	
TS-11WV	27011-5	N/A	15A/single pole	White	18	10	
TS-13V	27016-0	N/A	15A/3 way	Grey	18	10	
TS-15V	27287-4	N/A	20A/single pole	Grey 18	18	10	
TS-15AV	27288-1	N/A	20A/single pole	Bronze	18	10	
TS-15WV	27289-8	N/A	20A/single pole	White	18	10	
Blister Carded							
611-1	00611-0	108	15A/single pole	Grey	6	2	
611AB-1	27512-7	108	15A/single pole	Bronze	6	2	
611W-1	50075-5	108	15A/single pole	White	6	2	
613-1	00613-4	108	15A/3 way	Grey	6	3	
613AB-1	50081-6	108	15A/3 way	Bronze	6	3	
613W-1	50080-9	108	15A/3 way	White	6	3	

Dimensional cover drawing for:
TS-11V, TS-11V, TS-13V, TS-15V, 611, 613

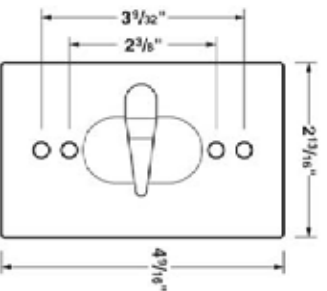

TWO GANG WEATHERPROOF COVERS - STAMPED STEEL

Two Gang Blank Cover

Stamped steel cover, gasket & screws included

BWF#	Unit UPC 0-871115	Unit Cubic	Cover	Description	Color	Case Qty.	Case Weight
Show Pak							
BC-2V	29010-6	N/A	Blank	Grey	24	3	
BC-2AV	27290-4	N/A	Blank	Bronze	24	3	
BC-2WV	27291-1	N/A	Blank	White	24	3	
Blister Carded							
722-1	00722-3	54	Blank	Grey	12	2	
722AB-1	29516-3	54	Blank	Bronze	12	2	
722W-1	50110-3	54	Blank	White	12	2	

Two Gang Cover for 1 GFCI Receptacle & 1 Single Switch or Receptacle

Die cast self closing cover, gasket & screws included

BWF#	Unit UPC 0-871115	Unit Cubic	Cover	Description	Color	Case Qty.	Case Weight
Show Pak							
FGV-291V	27292-8	N/A	Two Gang	Grey	18	9	



TS-11V



- All BWF switch covers are made of rugged, die cast metal construction.
- For use when weatherproof protection is required for an "on-off" type switch.



BC-2V



FGV-291V



TWO GANG WEATHERPROOF COVERS – DIE CAST METAL

Two Gang Cover for 1 GFCI Receptacle & 1 Duplex Receptacle, Switch or Combination Device

Die cast self closing cover, gasket & screws included



FGV-261V

BWF#	Unit UPC 0-87115	Unit Cubic	Cover	Description	Color	Case Qty.	Case Weight
Show Pak							
FGV-261V	27295-9	N/A	Two Gang	Two Gang	Grey	18	9
FGV-261AV	27296-6	N/A	Two Gang	Two Gang	Bronze 1	8	9

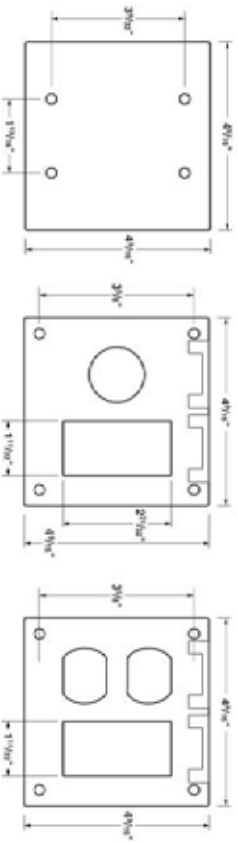

Two Gang Cover for 2 GFCI Receptacles

Self closing cover, gasket & screws included



FGV-2DCV

BWF#	Unit UPC 0-87115	Unit Cubic	Cover	Description	Color	Case Qty.	Case Weight
Show Pak							
FGV-2DCV	25031-5	N/A	Two Gang	Two Gang	Grey	18	9

Two Gang Cover for 1 GFCI Receptacle & 1 10A/20A Switch

Self closing, gasket & screws included



FGV-TS1V

BWF#	Unit UPC 0-87115	Unit Cubic	Cover	Description	Color	Case Qty.	Case Weight
Show Pak							
FGV-TS1V	25040-7	N/A	Two Gang	Two Gang	Grey	18	9

Two Gang Cover for 2 Duplex Receptacles, Switches or Combination Devices

Self closing cover, gasket & screws included



FC-261AV

BWF#	Unit UPC 0-87115	Unit Cubic	Cover	Description	Color	Case Qty.	Case Weight
Show Pak							
FC-261V	24011-8	N/A	Two Gang	Two Gang	Grey	18	10
FC-261AV	27303-1	N/A	Two Gang	Two Gang	Bronze	18	10
Blister Carded							
4261-1	04261-3	65	Two Gang	Two Gang	Grey	6	4
4261AB-1	24512-0	65	Two Gang	Two Gang	Bronze	6	4
4261W-1	50060-1	65	Two Gang	Two Gang	White	6	4

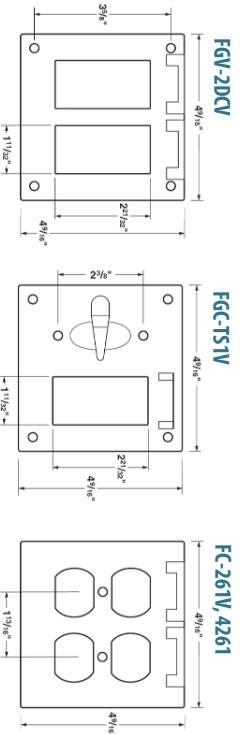

TWO GANG WEATHERPROOF COVERS – DIE CAST METAL

Universal Duplex Cover, Fits 1 Gang, 2 Gang & Round Boxes

Gasket & screws included

BWF#	Unit UPC 0-877115	Unit Cubic	Cover	Description	Color	Case Qty.	Case Weight
Show Pak							
FC-271V	27305-5	N/A	Universal	Universal	Grey	18	10



FC-271V

Two Gang Cover for 2 Single Receptacles and/or Switches

gasket & screws included

BWF#	Unit UPC 0-877115	Unit Cubic	Cover	Description	Color	Case Qty.	Case Weight
Show Pak							
FC-281V	24000-2	N/A	Two Gang	Two Gang	Grey	18	10
Blister Carded							
4281 -1	04281-1	65	Two Gang	Two Gang	Grey	6	4
4281AB-1	24502-1	65	Two Gang	Two Gang	Bronze	6	4
4281W-1	50055-7	65	Two Gang	Two Gang	White	6	4



FC-281V

Left & Right Lids Lock

Two Gang Cover for 1 Single Receptacle or Switch & 1 Duplex Receptacle, Switch or Combination Device

Gasket & screws included

BWF#	Unit UPC 0-877115	Unit Cubic	Cover	Description	Color	Case Qty.	Case Weight
Show Pak							
FC-291V	24716-2	N/A	Two Gang	Two Gang	Grey	18	11



FC-291V

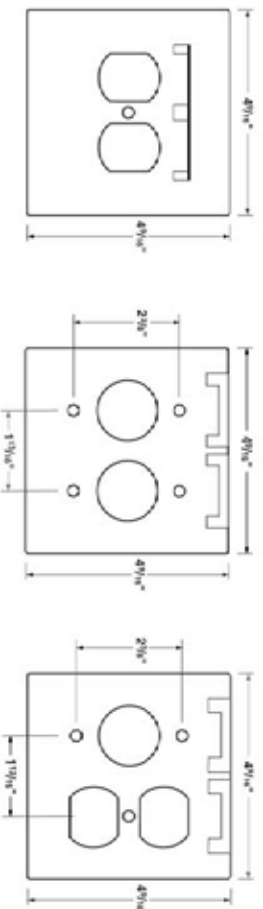



TWO GANG WEATHERPROOF COVERS – DIE CAST METAL

Two Gang Power Outlet Cover for Single Receptacle; 20A, 30A, 50A, 60A

Die cast self closing cover, gasket & screws included



TPO-50V

BWF#	Unit UPC	Unit Cubic	Opening	Description	Color	Case Qty.	Case Weight
Show Pak							
TPO-50V	26740-5	20A-50A	2.125"		Grey	24	9
TPOL-50V (Locking)	27321-5	20A-50A	2.125"		Grey	24	9
TPO-60V	27324-6	30A-60A	2.64"		Grey	24	9
TPOL-60V (Locking)	27327-7	30A-60A	2.64"		Grey	24	9
TPO-17V	27330-7	30A	1.75"		Grey	24	9

Two Gang Toggle Switch Cover for 2 15A-20A Switches

Stamped aluminum cover, gasket & screws included



TS-2V

BWF#	Unit UPC	Unit Cubic	Opening	Description	Color	Case Qty.	Case Weight
Show Pak							
TS-2V	27040-5	N/A	N/A		Grey	24	11

Power Outlet Covers:

- TPO-50V = 2.125"D
- TPOL-50V = 2.125"D
- TPO-60V = 2.64"D
- TPOL-60V = 2.64"D
- TPO-17V = 1.75"D

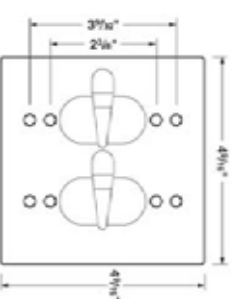
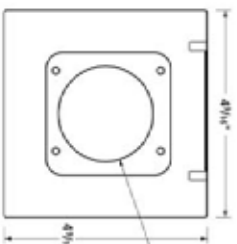

TS-2V



TS-21V

Two Gang Toggle Switch Cover with 2 Switches

Stamped aluminum cover, gasket & screws included

BWF#	Unit UPC	Unit Cubic	Switch	Description	Color	Case Qty.	Case Weight
Show Pak							
TS-21V	27040-5	N/A		(2)15A Single Pole	Grey	18	16
TS-25V	27345-1	N/A		(2)20A Single Pole	Grey	18	16

Two Gang Toggle Switch & Receptacle Cover for 1 Switch & 1 Single Receptacle

Die cast cover, gasket & screws included

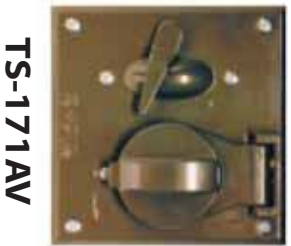

TS-171AV

BWF#	Unit UPC	Unit Cubic	Switch	Description	Color	Case Qty.	Case Weight
Show Pak							
TS-171AV	27349-9	N/A	N/A		Bronze	24	16
TS-171WV	27350-5	N/A	N/A		White	24	16

Two Gang Toggle Switch & Receptacle Cover for 1 Switch & 1 Duplex Receptacle

Die cast cover, gasket & screws included



TS-161V

BWF#	Unit UPC	Unit Cubic	Switch	Description	Color	Case Qty.	Case Weight
Show Pak							
TS-161V	27351-2	N/A	N/A		Grey	24	16
TS-161AV	27352-9	N/A	N/A		Bronze	24	16
TS-21V, TS-25V							
TS-171V							
TS-161V							

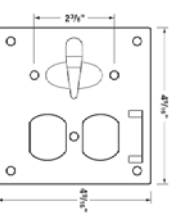
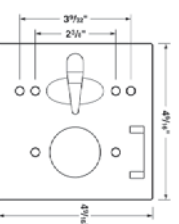
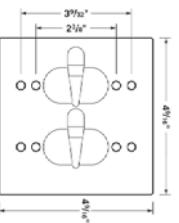

ROUND WEATHERPROOF COVERS – DIE CAST METAL

Ceiling Outlet Cover, 5" O.D., Flat with Beveled Edge

Stamped aluminum cover with mounting screws

BWF#	Unit UPC 0-87115	Unit Cubic	Cover	Description	Color	Case Qty.	Case Weight
Show Pak							
CC-3WV	27356-7	N/A		for 3" box	White	50	8
CC-4WV	27359-8	N/A		for 4" box	White	50	8



CC-3WV

Stamped aluminum covers, gasket & screws included

BWF#	Unit UPC 0-87115	Unit Cubic	Cover	Description	Color	Case Qty.	Case Weight
Show Pak							
RBCV	20100-3	N/A		Blank	Grey	50	10
RBCAV	52882-7	N/A		Blank	Bronze	50	10
RBCWV	52881-0	N/A		Blank	White	50	10



RBCV

Round Lampholder Cover, One 1/2" Hole, 4-1/2" Diameter

Die cast cover, gasket & screws included

BWF#	Unit UPC 0-87115	Unit Cubic	Cover	Description	Color	Case Qty.	Case Weight
Show Pak							
CR-1V	28006-0	N/A		1-1/2"	Grey	24	10
CR-1AV	52877-3	N/A		1-1/2"	Bronze	24	10
CR-1WV	52876-6	N/A		1-1/2"	White	24	10
Blister Carded							
931-1	00931-9	78		1-1/2"	Grey	6	2
931AB-1	28512-6	78		1-1/2"	Bronze	6	2
931W-1	50085-4	78		1-1/2"	White	6	2



CR-1V

Round Lampholder Cover, Three 1/2" Holes, 4-1/2" Diameter

Closure plugs, gasket & screws included

BWF#	Unit UPC 0-87115	Unit Cubic	Cover	Description	Color	Case Qty.	Case Weight
Show Pak							
CR-3V	28026-8	N/A		3-1/2"	Grey	24	10
CR-3AV	28525-6	N/A		3-1/2"	Bronze	24	10
CR-3WV	28725-0	N/A		3-1/2"	White	24	10
Blister Carded							
933-1	00933-3	78		3-1/2"	Grey	6	3
933AB-1	28532-4	78		3-1/2"	Bronze	6	3
933W-1	50090-8	78		3-1/2"	White	6	3



DS-1V

Automatic Door Operated Light Switch

Switch in "ON" when door is open

BWF#	Unit UPC 0-87115	Unit Cubic	Switch	Description	Color	Case Qty.	Case Weight
Show Pak							
DS-1V	09005-8	N/A		Automatic	Metal	24	2.5

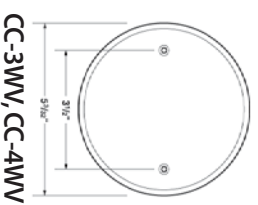

CC-3WV, CC-4WV

Additional knock-outs provided for mounting to 3-1/2" round box

CR-1V, 931

RBCV



LAMP HOLDERS – DIE CAST METAL

BWF Product Benefits & Features

- Rugged, seamless die-cast construction that prevents moisture entry
- State of the art powder coat finish for maximum durability
- Locking swivel knuckle allows positive lamp positioning and pin-point directional aiming
- Lampholders supplied with porcelain sockets, internal gaskets, extra long wire leads, hardware and installation instructions

Applications

- For exterior or interior lighting
- For safety and security, light walkways, driveways and doorways

Die Cast Lampholder

Porcelain socket & internal gasket included

BWF#	Unit UPC 0-87115	Unit Cubic	Type	Description	Color	Case Qty.	Case Weight
Bulk							
HU-1	30015-7	N/A	Unfinished		Metal	50	25
Show Pak							
H-1V	30006-5	N/A	with leads		Grey	27	14
H-1AV	30505-3	N/A	with leads		Bronze	27	14
H-1WV	30705-7	with leads	White		27	14	
Blister Cased							
1001-1	01001-8	86	with leads		Grey	6	4
1001AB-1	30156-7	86	with leads		Bronze	6	4
1001W-1	50115-8	86	with leads		White	6	4

Die Cast Lampholder with External Gasket

Porcelain socket & internal gasket included

BWF#	Unit UPC 0-87115	Unit Cubic	Type	Description	Color	Case Qty.	Case Weight
Show Pak							
HG-100V	27370-3	N/A	H1 w/gasket		Grey	27	15
HG-100AV	27371-0	N/A	H1 w/gasket		Bronze	27	15
HG-100WV	27372-7	N/A	H1 w/gasket		White	27	15

Die Cast Lampholder with Attached 5-1/2" Hood

Porcelain socket & internal gasket included

BWF#	Unit UPC 0-87115	Unit Cubic	Type	Description	Color	Case Qty.	Case Weight
Bulk							
H-90	31005-7	248	5-1/2" Hood		Grey	6	6
H-90AB	31505-2	248	5-1/2" Hood		Bronze	6	6
H-90W	31705-6	248	5-1/2" Hood		White	6	6
Display Packaging							
HH55	04455-6	248	5-1/2" Hood		Grey	6	7
HH55AB	31507-6	248	5-1/2" Hood		Bronze	6	7
HH55W	50120-2	248	5-1/2" Hood		White	6	7
HH55B	31506-9	248	5-1/2" Hood		Black	6	7

Die Cast Lampholder with Attached 5-1/8" Contemporary Hood

Porcelain socket & internal gasket included

BWF#	Unit UPC 0-87115	Unit Cubic	Type	Description	Color	Case Qty.	Case Weight
Bulk							
H-92	31022-4	248	Contemporary		Grey	6	7
H-92AB	31522-9	248	Contemporary		Bronze	6	7
H-92W	50131-8	248	Contemporary		White	6	7
Display Packaging							
HH75	04475-4	248	Contemporary		Grey	6	7
HH75AB	31523-6	248	Contemporary		Bronze	6	7
HH75W	50130-1	248	Contemporary		White	6	7

All BWF incandescent lampholders use one 150 Watt maximum standard base floodlight bulb. Bulbs not included.

H1V

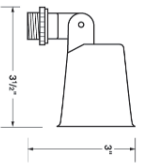

H-92



H-90



H-1V



HG-100V



H-90, HH55

H-92, HH75



LAMP HOLDERS – DIE CAST METAL

Slip Fitter Pole Top Adapters

For use with troughs or boxes

BWF#	Unit UPC 0-87115	Unit Cubic	Type	Description	Color	Case Qty.	Case Weight
A-20	39020-2	40	1/2" NPT	Metal		10	4



A-20

Two Lamp Swivel Light with Deep Ceiling Plate

Deep ceiling plate, 2 adjustable lampholders, porcelain sockets & internal gaskets

BWF#	Unit UPC 0-87115	Unit Cubic	Type	Description	Color	Case Qty.	Case Weight
Boxed							
SVLD-2	31136-8	125		Deep Box	Grey	8	14
SVLD-2AB	31537-3	125		Deep Box	Bronze	8	14
SVLD-2W	31737-7	125		Deep Box	White	8	14



Round One Lamp Floodlight Includes:

1 lampholder with porcelain socket, round cover, gaskets & screws

BWF#	Unit UPC 0-87115	Unit Cubic	Type	Description	Color	Case Qty.	Case Weight
Show Pak							
LHC-1V	31025-5	N/A		RD 1 Lamp	Grey	8	7.5
LHC-1W	31525-0	N/A		RD 1 Lamp	Bronze	8	7.5
LHC-1WV	31725-4	N/A		RD 1 Lamp	White	8	7.5
Blister Carded							
93101-1	66599-7	175		RD 1 Lamp	Grey	6	6
93101AB-1	31526-71	75		RD 1 Lamp	Bronze	6	6
93101W-1	50135-6	175		RD 1 Lamp	White	6	6
93101B-1	31527-4	175		RD 1 Lamp	Black	6	6

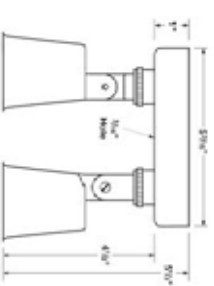

SVLD-2

Round Two Lamp Floodlight Includes:

2 lampholders with porcelain sockets, 3 hole round cover, gaskets & screws

BWF#	Unit UPC 0-87115	Unit Cubic	Type	Description	Color	Case Qty.	Case Weight
Show Pak							
LHC-2V	31035-4	N/A		RD 2 Lamp	Grey	8	10.5
LHC-2W	31535-9	N/A		RD 2 Lamp	Bronze	8	10.5
LHC-2WV	31735-3	N/A		RD 2 Lamp	White	8	10.5
Blister Carded							
93102-1	66600-0	192		RD 2 Lamp	Grey	6	9
93102AB-1	31531-1	192		RD 2 Lamp	Bronze	6	9
93102W-1	50140-0	192		RD 2 Lamp	White	6	9
93102B-1	31530-4	192		RD 2 Lamp	Black	6	9



LHC-1V



LHC-2V

Round Two Lamp Floodlight Kit Includes:

2 lampholders with porcelain sockets, 3 hole round cover, 5 hole round box, gaskets & screws

BWF#	Unit UPC 0-87115	Unit Cubic	Type	Description	Color	Case Qty.	Case Weight
Clamshell Kit							
ZHRBK-C-1	02437-4	220		RD 2 Lamp Kit	Grey	10	21
ZHRBKAB-C-1	02438-1	220		RD 2 Lamp Kit	Bronze	10	21
ZHRBKW-C-1	02439-8	220		RD 2 Lamp Kit	White	10	21
ZHRKB-C-1	02440-4	220		RD 2 Lamp Kit	Black	10	21
Display Packaging							
ZHRBK	02430-5	180		RD 2 Lamp Kit	Grey	10	23
ZHRBKAB	02436-7	180		RD 2 Lamp Kit	Bronze	10	23
ZHRBKW	50190-5	180		RD 2 Lamp Kit	White	10	23
ZHRKB	02435-0	180		RD 2 Lamp Kit	Black	10	23



ZHRBK



LAMP HOLDERS – DIE CAST METAL

Rectangular One Lamp Floodlight Includes:

1 lampholder with porcelain socket, 1 hole rectangular cover, gaskets & screws



LHR-1V

BWF#	Unit UPC 0-87115	Unit Cubic	Type	Description	Color	Case Qty.	Case Weight
Show Pak							
LHR-1V	31055-2	N/A	RT 1 Lamp	RT 1 Lamp	Grey	8	6.5
LHR-1AV	31555-7	N/A	RT 1 Lamp	RT 1 Lamp	Bronze	8	6.5
LHR-1WV	31755-1	N/A	RT 1 Lamp	RT 1 Lamp	White	8	6.5

Rectangular Two Lamp Floodlight Includes:

2 lampholders with porcelain sockets, 3 hole rectangular cover, plug, gaskets & screws



LHR-2V

BWF#	Unit UPC 0-87115	Unit Cubic	Type	Description	Color	Case Qty.	Case Weight
Show Pak							
LHR-2V	31065-1	N/A	RD 2 Lamp	RD 2 Lamp	Grey	8	10
LHR-2AV	31565-6	N/A	RD 2 Lamp	RD 2 Lamp	Bronze	8	10
LHR-2WV	31765-0	N/A	RD 2 Lamp	RD 2 Lamp	White	8	10

Rectangular Two Lamp Floodlight Kit Includes:

2 lampholders w/porcelain sockets, 3 hole rectangular cover, 3 hole rectangular box, gaskets & screws



2HBKC

BWF#	Unit UPC 0-87115	Unit Cubic	Type	Description	Color	Case Qty.	Case Weight
Clamshell Kit							
2HBK-C-1	02401-5	309	RT 2 Lamp Kit	RT 2 Lamp Kit	Grey	10	20
2HBKAB-C-1	02402-2	309	RT 2 Lamp Kit	RT 2 Lamp Kit	Bronze	10	20
2HBKW-C-1	02403-9	309	RT 2 Lamp Kit	RT 2 Lamp Kit	White	10	20
2HBKB-C-1	02404-6	309	RT 2 Lamp Kit	RT 2 Lamp Kit	Black	10	20
Display Box Kit							
2HBK	02400-8	180	RT 2 Lamp Kit	RT 2 Lamp Kit	Grey	10	20
2HBKAB	02406-0	180	RT 2 Lamp Kit	RT 2 Lamp Kit	Bronze	10	20
2HBKW	50185-11	80	RT 2 Lamp Kit	RT 2 Lamp Kit	White	10	20
2HBKB	02405-3	180	RT 2 Lamp Kit	RT 2 Lamp Kit	Black	10	20

Rectangular Three Lamp Floodlight Kit Includes:

3 lampholders w/porcelain sockets, 3 hole rectangular cover, 3 hole rectangular box, gaskets & screws



LHR-3V

BWF#	Unit UPC 0-87115	Unit Cubic	Type	Description	Color	Case Qty.	Case Weight
Show Pak							
LHR-3AV	27393-2	N/A	RT 3 Lamp	RT 3 Lamp	Bronze	8	13
LHR-3WV	27394-9	N/A	RT 3 Lamp	RT 3 Lamp	White	8	13

Contemporary Two Lamp Floodlight Kit Includes:

2 lampholders, 3 hole rectangular cover, 3 hole rectangular box, gaskets & screws



2H75K

BWF#	Unit UPC 0-87115	Unit Cubic	Type	Description	Color	Case Qty.	Case Weight
Display Box Kit							
2H75KW	50215-5	547	RT 2 Lamp Kit	RT 2 Lamp Kit	White	6	19
2H75KB	24755-1	547	RT 2 Lamp Kit	RT 2 Lamp Kit	Black	6	19

Every BWF Kit is a complete weatherproof installation. All hardware and components are included, making additional purchases unnecessary. Each kit includes illustrated, easy-to-install instructions.



SECURITY LIGHTING – DIE CAST METAL

BWF has a complete line of Security Lighting and Photoelectric components and replacement parts. Automatic night switches will effectively light and protect an area from dusk until dawn. They are used for sunset activated control of night lighting and may be used for many applications, such as: porch lights; garden lights, post lanterns, barn lights, loading dock areas, industrial sites and outdoor signage. A built in time delay prevents operation triggered by auto headlamps or other temporary light flashes.

Rectangular Two Lamp Security Light Includes:

2 lampholders w/porcelain sockets, 3 hole rectangular cover with photoelectric eye, gaskets & screws

BWF#	Unit UPC 0-87115	Unit Cubic	Outlets	Description	Color	Case Qty.	Case Weight
Clamshell Kit							
SL-2C-1	50147-9	309	RT 2 Lamp Kit	Grey	10	19	
SL-2BC-1	50151-6	309	RT 2 Lamp Kit	Black	10	19	
Display Box Kit							
SL-2	00782-7	180	RT 2 Lamp Kit	Grey	10	21	
SL-2B	50146-2	180	RT 2 Lamp Kit	Black	10	21	



SL-2

CHROME PLATED CLAMP-ON GUARD – FOR BULB PROTECTION

Clamp-on Guard – Chrome Plated

Fits H-1 lampholders for floodlight bulb protection

BWF#	Unit UPC 0-87115	Unit Cubic	Type	Description	Color	Case Qty.	Case Weight
Clamshell Kit							
GD-100V	31169-6	N/A	Clamp		Chrome	5	2.5



GD-100V



Lights will automatically come on at dusk



Avoid accidents and intrusions by brightly illuminating walkways and driveways.



Deter crime by brightly lighting areas that might otherwise attract a potential burglar.



GARDEN LIGHTING – DIE CAST METAL

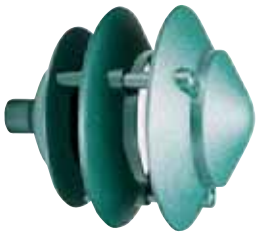

P-3

Incandescent: 75W max,
Bulb not included



P-4

Incandescent: 75W max,
Bulb not included



Isolux Curve

Wattage	Multiplier	Wattage	Multiplier
150	1.0	50	.27
75	.68	40	.26
60	.44	25	.13

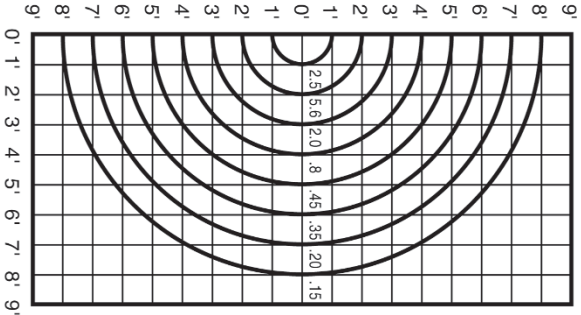

Photometrics:

Based on lamp center 24" above ground. Based on 100 Watt A-19 inside frosted 1750 lumen lamp. For other wattage see table above.



BWF Product Benefits & Features

- Rugged, seamless, die-cast construction that does not allow moisture entry
- State of the art powder coat finish for maximum durability
- Includes screw-in clear glass globe, 5" for 3-Tier, 7" for 4-Tier lights

Applications

- For accent lighting along walkways, driveways, • Lighting around pools, patios and garden areas terraces and porches • Accent shrubbery and landscaping

Three Tier Louver Light with 5" Glass Globe

1/2" NPT base, 110/120V 75 Watt Max

BWF#	Unit UPC 0-87115	Pipe Size	Type	Description	Color	Case Qty.	Case Weight
Boxed							
P-3	33005-5	333	3 Tier	Green	Green	6	18
P-3AB	33510-4	333	3 Tier	Bronze	Bronze	6	18
P-3W	33705-4	333	3 Tier	White	White	6	18
P-3B	33010-9	333	3 Tier	Black	Black	6	18
LL3	00883-1	347	3 Tier	Green	Green	6	18

Four Tier Louver Light with 7" Glass Globe

1/2" NPT base, 110/120V 100 Watt Max

BWF#	Unit UPC 0-87115	Pipe Size	Type	Description	Color	Case Qty.	Case Weight
Boxed							
P-4	33015-4	333	4Tier	Green	Green	6	22
P-4AB	33515-9	333	4Tier	Bronze	Bronze	6	22
P-4W	33706-1	333	4Tier	White	White	6	22
P-4B	33020-8	333	4Tier	Black	Black	6	22
LL4	00884-8	347	4Tier	Green	Green	6	23

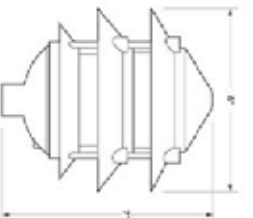

P-3

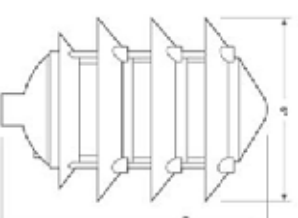

P-4

GARDEN LIGHTING – DIE CAST METAL

Portable SpikeLite

1 - H-1 lampholder with external gasket, 7" ground spike, 6 ft 18/3 cord w/molded plug

BWF#	Unit UPC	Unit	Type	Description	Color	Case Qty.	Case Weight
Show Pak							
SP-1V	27309-4	N/A	H-1 w/Spike/Cord	Grey	Grey	6	7
SP-1GV	31193-1	N/A	H-1 w/Spike/Cord	Green	Green	6	7
Bulk Pallet							
SP-1	33130-4	N/A	H-1 w/Spike/Cord	Grey	Grey	80	90
SP-1G	31194-8	N/A	H-1 w/Spike/Cord	Green	Green	80	90



SP-1V

Replacement Parts and Accessories for Garden Lighting

BWF#	Unit UPC	Unit	Type	Description	Color	Case Qty.	Case Weight
Boxed							
G-5	33085-7	N/A	5" Globe	Clear Glass	Clear Glass	40	32
G-7	33090-1	N/A	6" Globe	Clear Glass	Clear Glass	32	33
Show Pak							
MGSV	21030-2	N/A	7" Ground spike	Grey	Grey	18	6



G-5



G-7



MGSV



VAPORTIGHT FIXTURES – INCANDESCENT

Pendant Fixtures

1/2" & 3/4" NPT base, 110/120V, fully enclosed & gasketed



VPKG-11

BWF#	Unit UPC 0-87115	Hub Size	Wattage	Description	Color	Case Qty.	Case Weight
Boxed							
VPKG-11L	14020-3	1/2"	75	Lexan® Clear	Clear	6	10
VPKG-21L	14025-8	3/4"	75	Lexan® Clear	Clear	6	10
VPKG-11	14030-2	1/2"	100	Glass Clear	Clear	6	13
VPKG-21	14035-7.3	1/4"	100	Glass Clear	Clear	6	13
VPKG-12L	14220-7	1/2"	100	Lexan® Clear	Clear	1	2.1
VPKG-22L	14225-2	3/4"	100	Lexan® Clear	Clear	1	2.1
VPKG-12	14230-6	1/2"	200	Glass Clear	Clear	1	3.6
VPKG-22	14235-1	3/4"	200	Glass Clear	Clear	1	3.6

Pendant Fixtures with Guard

1/2" & 3/4" NPT base, 110/120V, fully enclosed & gasketed



VPKG-11-G

BWF#	Unit UPC 0-87115	Hub Size	Wattage	Description	Color	Case Qty.	Case Weight
Boxed							
VPKG-11-G	14040-1	1/2"	100	Glass Clear	Clear	6	16
VPKG-11-G	14039-5	1/2"	100	Glass Clear	Clear	6	20
VPKG-21-G	14045-6	3/4"	100	Glass Clear	Clear	6	16
VPKG-21-G	14044-9	3/4"	100	Glass Clear	Clear	6	20
VPKG-12-G	14240-5	1/2"	200	Glass Clear	Clear	1	4.1
VPKG-22-G	14245-0	3/4"	200	Glass Clear	Clear	1	4.1

VAPORTIGHT FIXTURES – INCANDESCENT

Surface Mount Fixtures for Round or Octagonal Boxes

Fits all 3-1/2" and 4" round boxes, 1/2" & 3/4" NPT base, 110/120V, fully enclosed & gasketed

BWF#	Unit UPC 0-87115	Hub Size	Wattage	Description	Color	Case Qty.	Case Weight
Boxed							
VPAG-01L	14050-0	3-1/2 & 4"	75	Lexan® Clear	Clear	6	7
VPAG-01	14055-5	3-1/2 & 4"	100	Glass Clear	Clear	6	10
VPAG-02L	14250-4	3-1/2 & 4"	100	Lexan® Clear	Clear	1	1.5
VPAG-02	14255-9	3-1/2 & 4"	200	Glass Clear	Clear	1	3.0

Surface Mount Fixtures for Round or Octagonal Boxes

Fits all 3-1/2" and 4" round boxes, 1/2" & 3/4" NPT base, 110/120V, fully enclosed & gasketed

BWF#	Unit UPC 0-87115	Hub Size	Wattage	Description	Color	Case Qty.	Case Weight
Boxed							
VPAG-01L	14050-0	3-1/2 & 4"	75	Lexan® Clear	Clear	6	7
VPAG-01	14055-5	3-1/2 & 4"	100	Glass Clear	Clear	6	10
VPAG-02L	14250-4	3-1/2 & 4"	100	Lexan® Clear	Clear	1	1.5
VPAG-02	14255-9	3-1/2 & 4"	200	Glass Clear	Clear	1	3.0



VPKG-11-CG

VPAG-01-G



VPAG-01-CG

G = Wire Guard CH = Cast Guard

Fits all 3-1/2" and 4" round boxes, 1/2" & 3/4" NPT base, 110/120V, fully enclosed & gasketed

BWF#	Unit UPC 0-87115	Hub Size	Wattage	Description	Color	Case Qty.	Case Weight
Boxed							
VPAG-01-G	14060-9	3-1/2 & 4"	100	Glass Clear	Clear	6	18
VPAG-01-CG	14059-3	3-1/2 & 4"	100	Glass Clear	Clear	6	20
VPAG-02-G	14260-3	3-1/2 & 4"	200	Glass Clear	Clear	1	3.5

INCANDESCENT: 75W, 100W, 200W, see individual products, bulb not included.

IMPORTANT:

- Vaportight fixtures are not for use in hazardous locations.
- Fixtures supplied with glass globes are furnished with "Clear" Lexan globes. See page 31 for glass globes.
- Standard Lexan® fixtures have "Clear" Lexan globes. To order any of those fixtures with Red, White, Amber or Green globes, add the suffix "R", "W", "A" or "G" to the catalog number. See page 31 for Lexan® globes.

LEXAN® is a registered trademark of General Electric Co.

Box Mounted Fixture for Wall or Ceiling

Four sided holes taped, 1/2" & 3/4" NPT base, 110/120V, fully enclosed & gasketed, 3 plugs

BWF#	Unit UPC 0-87115	Box Size	Wattage	Description	Color	Case Qty.	Case Weight
Boxed							
VPXG-11L	14065-4	1/2"	75	Lexan® Clear	Clear	6	10
VPXG-21L	14070-8	3/4"	75	Lexan® Clear	Clear	6	10
VPXG-11	14075-3	1/2"	100	Glass Clear	Clear	6	13
VPXG-21	14080-7	3/4"	100	Glass Clear	Clear	6	13
VPXG-12L	14265-8	1/2"	100	Lexan® Clear	Clear	1	1.9
VPXG-22L	14270-2	3/4"	100	Lexan® Clear	Clear	1	2.1
VPXG-12	14275-7	1/2"	200	Glass Clear	Clear	1	3.6
VPXG-22	14280-1	3/4"	200	Glass Clear	Clear	1	3.6



VPXG-11



VPXG-11-G



VAPORTIGHT FIXTURES – INCANDESCENT

Box Mounted Fixture for Wall or Ceiling with Guard

Four sided holes taped, 1/2" & 3/4" NPT base, 110/120V, fully enclosed & gasketed, 3 plugs



VPXG-11-CG



VPG-01



VPG-01-G



VWG-01-CG

G = Wire Guard CH = Cast Guard

BWF#	Unit UPC 0-87115	Box Size	Wattage	Description	Color	Case Qty.	Case Weight
Boxed							
VPXG-11-G	14085-2	1/2"	100	Glass Clear	Glass Clear	6	16
VPXG-11-CG	14086-9	1/2"	100	Glass Clear	Glass Clear	6	20
VPXG-21-G	14090-6	3/4"	100	Glass Clear	Glass Clear	6	16
VPXG-21-CG	14092-0	3/4"	100	Glass Clear	Glass Clear	6	20
VPXG-12-G	14285-6	1/2"	200	Glass Clear	Glass Clear	1	4.2
VPXG-22-G	14286-3	3/4"	200	Glass Clear	Glass Clear	1	4.2

Wall Mount Fixture with Right Angle Bracket

For use with 4" box, 110/120V, fully enclosed & gasketed

BWF#	Unit UPC 0-87115	Box Size	Wattage	Description	Color	Case Qty.	Case Weight
Boxed							
VWG-01L	14011-1	4"	75	Lexan® Clear	Glass Clear	1	2.0
VWG-01	14021-0	4"	100	Glass Clear	Glass Clear	1	2.8
VWG-02L	14287-0	4"	100	Lexan® Clear	Lexan® Clear	1	2.4
VWG-02	14288-7	4"	200	Glass Clear	Glass Clear	1	3.7

Wall Mount Fixture with Right Angle Bracket with Guard

For use with 4" box, 110/120V, fully enclosed & gasketed

BWF#	Unit UPC 0-87115	Box Size	Wattage	Description	Color	Case Qty.	Case Weight
Boxed							
VWG-01-G	14031-9	4"	100	Glass Clear	Glass Clear	1	3.2
VWG-01-CG	14032-6	4"	100	Glass Clear	Glass Clear	1	4.1
VWG-02-G	14289-4	4"	200	Glass Clear	Glass Clear	1	4.2

INCANDESCENT: 75W, 100W, 200W, see individual products, bulb not included.

IMPORTANT:

- Vaportight fixtures are not for use in hazardous locations.
- Fixtures supplied with glass globes are furnished with "Clear" glass. See page 31 for glass globes.
- Standard Lexan® fixtures have "Clear" Lexan globes. To order any of those fixtures with Red, White, Amber or Green globes, add the suffix "R," "W," "A" or "G" to the catalog number. See page 31 for Lexan® globes.

LEXAN® is a registered trademark of General Electric Co.

VAPORTIGHT FIXTURES – INCANDESCENT

Wall Mount Fixture with Right Angle Bracket & Box

Factory assembled to 4" weatherproof box, 110/120V, fully enclosed & gasketed, 3 plugs

BWF#	Unit UPC 0-87115	Box Size	Wattage	Description	Color	Case Qty.	Case Weight
Boxed							
VXWG-11L	14041-8	1/2"	75	Lexan® Clear	1	1	2.7
VXWG-21L	14051-7	3/4"	75	Lexan® Clear	1	1	3.0
VXWG-11	14061-6	1/2"	100	Glass Clear	1	1	3.4
VXWG-21	14071-5	3/4"	100	Glass Clear	1	1	3.4
VXWG-12L	14290-0	1/2"	100	Lexan® Clear	1	1	3.1
VXWG-22L	14291-7	3/4"	100	Lexan® Clear	1	1	3.1
VXWG-12	14292-4	1/2"	200	Glass Clear	1	1	4.5
VXWG-22	14293-1	3/4"	200	Glass Clear	1	1	4.5



VXWG-11



VXWG-11-G



VXWG-11-CG

G = Wire Guard CG = Cast Guard

Wall Mount Fixture with Right Angle Bracket & Box with Guard

Factory assembled to 4" weatherproof box, 110/120V, fully enclosed & gasketed, 3 plugs

BWF#	Unit UPC 0-87115	Box Size	Wattage	Description	Color	Case Qty.	Case Weight
Boxed							
VXWG-11-G	14081-4	1/2"	100	Glass Clear	1	1	3.8
VXWG-11-GG	14082-1	1/2"	100	Glass Clear	1	1	4.7
VXWG-21-G	14091-3	3/4"	100	Glass Clear	1	1	3.8
VXWG-21-GG	14089-0	3/4"	100	Glass Clear	1	1	4.7
VXWG-12-G	14294-8	1/2"	200	Glass Clear	1	1	5.1
VXWG-22-G	14295-5	3/4"	200	Glass Clear	1	1	5.1

VAPORTIGHT FIXTURES – INCANDESCENT

BWF Product Benefits & Features

- Rugged, seamless, die-cast construction that prevents moisture entry
- State of the art powder coat finish for maximum durability
- All fixtures are industrial grade, factory assembled and fully gasketed
- Engineered to protect the interior from deteriorating effects of ice, corrosive fumes, non-explosive vapors, etc.
- Choose between heat resistant glass globes or Lexan® plastic globes in a choice of colors, see page 31
- 75, 100 and 200 Watt Incandescent fixtures – 7 and 13 Watt PL Fluorescent fixtures

Applications

- For use in severe service areas where extreme conditions prevail
- Applications: subways, construction sites, bridges, tunnels, freezers, waste water & sewage treatment plants

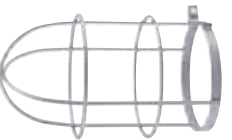

Wire Guard - VPGW

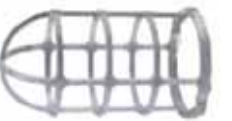

Cast Guard - BPCG



Pendant - VPKG



Ceiling Mount - VPAG



Box Mounted - VPXG



**Right Angle Wall
Mount - VWG**



**Right Angle Wall
Mount Assembled
to Box - VXXWG**





VAPORTIGHT FIXTURES – INCANDESCENT

Replacement Parts & Accessories

Boxed	BWF #	Unit UPC 0-87115	Hub Size	Max Wattage	Description	Color	Case Qty.	Case Weight
	VPK-11	15020-2	1/2"	100	Pendant cap,	Grey	10	18
	VPK-21	15025-7	3/4"	100	porcelain socket	Grey	10	18
	VPK-12	15220-6	1/2"	200	gasket and screws	Grey	10	10
	VPK-22	15225-1	3/4"	200		Grey	10	10
	VPA-01-N	15030-1	N/A	100	Ceiling box cap, socket	Grey	10	12
	VPA-02	15230-5	N/A	200	gasket and screws	Grey	10	12
	VPX-11	15035-6	1/2"	100	Ceiling mount box	Grey	10	19
	VPX-21	15040-0	3/4"	100	with gaskets,	Grey	10	19
	VPX-12	15235-0	1/2"	200	porcelain socket	Grey	10	19
	VPX-22	15240-4	3/4"	200	and screws	Grey	10	19
	VPL-1	14271-9	5 - 1/2"	N/A	Cross feed box 5 hole	Grey	10	9
	VPL-13	14272-6	5 - 3/4"	N/A	with gaskets	Grey	10	9
	VW-01	14096-8	N/A	100	Right angle bracket	Grey	10	21
	VW-02	14196-5	N/A	200	gasket, socket, screws	Grey	6	12
	VXW-11	14097-5	1/2"	100		Grey	1	3
	VXW-21	14297-9	3/4"	100	Right angle bracket	Grey	1	3
	VXW-12	14098-2	1/2"	200	attached box, gasket	Grey	1	1.5
	VXW-22	14298-6	3/4"	200	socket and screws	Grey	1	1.5
	VPG	15044-8	N/A	100	Heavy duty cast	Cast Zinc	5	7
	VPGW	15045-5	#8 AMS	100		Wire	5	4
	VPGW-02	15046-2	#8 AMS	200	Heavy duty	Wire	1	1
	VPL-01	15050-9	N/A	100	wire guard	Glass Clear	1	1.5
	VPL-02	15051-6	N/A	200		Glass Clear	1	2
	VPLL-01	15055-4	N/A	75		Lexan® Clear	12	3
	VPLL-01R	15060-8	N/A	75	Lexan® globe	Lexan® Red	12	3
	VPLL-01W	15065-3	N/A	75	for 100 Watt	Lexan® White	12	3
	VPLL-01A 1	5070-7	N/A	75	and 200 Watt	Lexan® Amber	12	3
	VPLL-01G	15056-1	N/A	75	fixtures	Lexan® Green	12	3
	VPLL-02	15071-4	N/A	150		Lexan® Clear	6	5
	AP-1	15075-2	3 1/2 & 4"	N/A	Adapter plate w/gasket	Metal	20	4
	PL-5	21005-0	1/2"	N/A	Closure Plug	Metal	1000	20
	PL-75	21010-4	3/4"	N/A	Closure Plug	Metal	1000	21



VAPORTIGHT FIXTURES – INCANDESCENT

VPKG Without Guard

Cat No	A	B
VPKG-11L	3-11/16"	8-3/16"
VPKG-21L	3-11/16"	8-3/16"
VPKG-11	3-11/16"	8-3/16"
VPKG-21	3-11/16"	8-3/16"
VPKG-12L	4-3/8"	10-1/2"
VPKG-22L	4-3/8"	10-1/2"
VPKG-12	4-3/8"	10-1/2"
VPKG-22	4-3/8"	10-1/2"

VPKG With Guard

Cat No	C	D
VPKG-11-G	4-1/4"	9-5/8"
VPKG-11-CG	4-1/4"	9-5/8"
VPKG-21-G	4-1/4"	9-5/8"
VPKG-21-CG	4-1/4"	9-5/8"
VPKG-12-G	5-1/2"	11"
VPKG-22-G	5-1/2"	11"

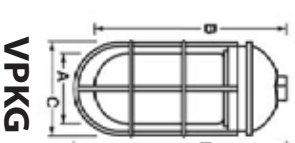

VPKG

VPAG Without Guard

Cat No	A	B
VPAG-01L	3-11/16"	6-13/16"
VPAG-01	3-11/16"	6-13/16"
VPAG-02L	4-3/8"	8-1/2"
VPAG-02	4-3/8"	8-1/2"

VPAG With Guard

Cat No	C	D
VPAG-01-G	4-1/4"	7-9/16"
VPAG-01-CG	4-1/4"	7-9/16"
VPAG-02-G	5-1/2"	9"

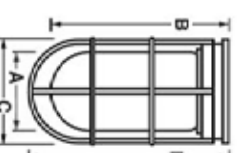

VPAG

VPXG Without Guard

Cat No	A	B
VPXG-11L	3-11/16"	8-5/8"
VPXG-21L	3-11/16"	8-5/8"
VPXG-11	3-11/16"	8-5/8"
VPXG-21	3-11/16"	8-5/8"
VPXG-12L	4-3/8"	10-1/2"
VPXG-22L	4-3/8"	10-1/2"
VPXG-12	4-3/8"	10-1/2"
VPXG-22	4-3/8"	10-1/2"

VPXG With Guard

Cat No	A	B
VPXG-11-G	4-1/4"	9-1/8"
VPXG-11-CG	4-1/4"	9-1/8"
VPXG-21-G	4-1/4"	9-1/8"
VPXG-21-CG	4-1/4"	9-1/8"
VPXG-12-G	5-1/2"	10-3/4"
VPXG-22-G	5-1/2"	10-3/4"

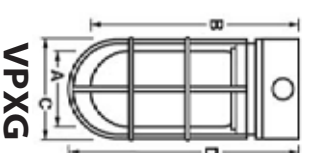

VPXG

VWG Without Guard

Cat No	A	B	E	F
VWG-01L	3-11/16"	7-1/4"	3"	4-1/4"
VWG-01	3-11/16"	7-1/4"	3"	4-1/4"
VWG-02L	4-3/8"	8-3/4"	3"	4-1/2"
VWG-02	4-3/8"	8-3/4"	3"	4-1/2"

VWG With Guard

Cat No	C	D	E	F
VWG-01-G	4-1/4"	7-3/4"	3"	4-1/4"
VWG-01-CG	4-1/4"	7-3/4"	3"	4-1/4"
VWG-02-G	5-1/2"	9-1/4"	3"	4-1/2"

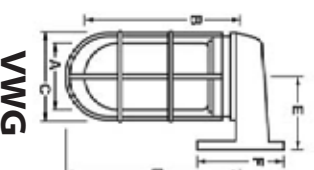

VWG

VXWG Without Guard

Cat No	A	B	E	F
VXWG-11L	3-11/16"	7-1/4"	4-1/2"	4-1/4"
VXWG-21L	3-11/16"	7-1/4"	4-1/2"	4-1/4"
VXWG-11	3-11/16"	7-1/4"	4-1/2"	4-1/4"
VXWG-21	3-11/16"	7-1/4"	4-1/2"	4-1/4"
VXWG-12L	4-3/8"	8-3/4"	4-1/2"	4-1/2"
VXWG-22L	4-3/8"	8-3/4"	4-1/2"	4-1/2"
VXWG-12	4-3/8"	8-3/4"	4-1/2"	4-1/2"
VXWG-22	4-3/8"	8-3/4"	4-1/2"	4-1/2"

VXWG With Guard

Cat No	C	D	E	F
VXWG-11-G	4-1/4"	7-3/4"	4-1/2"	4-1/4"
VXWG-11-CG	4-1/4"	7-3/4"	4-1/2"	4-1/4"
VXWG-21-G	4-1/4"	7-3/4"	4-1/2"	4-1/4"
VXWG-21-CG	4-1/4"	7-3/4"	4-1/2"	4-1/4"
VXWG-12-G	5-1/2"	9-1/4"	4-1/2"	4-1/2"
VXWG-22-CG	5-1/2"	9-1/4"	4-1/2"	4-1/2"

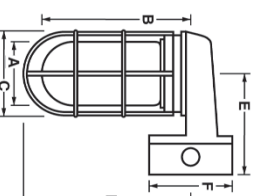

VXWG

CONDUIT BODIES – DIE CAST METAL

BWF Product Benefits & Features

- Rugged, seamless, die-cast construction that prevents moisture entry
- Flat back design for easy mounting close to walls

Applications

- Threaded style conduit bodies are for use on rigid conduit.
- Use BWF conduit outlet bodies for connecting conduit sections, for making bends in conduit runs, as pull outlets, or to provide openings for making splices and taps in conductors.
- State-of-the-art powder coat finish for maximum durability
- May be used on aluminum or steel conduit



500V



D100V



10V



Type SLB – Aluminum Conduit Entrance Ells

Cover & screws included, for rigid conduit

BWF#	Unit UPC 0-87115	Conduit Size	Type	Description	Color	Case Qty.	Case Weight
Show Pak							
500V	75005-1	1/2"	SLB Threaded	Grey	Grey	38	8
501V	75010-5	3/4"	SLB Threaded	Grey	Grey	36	8
502V	75015-0	1"	SLB Threaded	Grey	Grey	12	6
503V	75020-4	1-1/4"	SLB Threaded	Grey	Grey	12	11.5
504V	75025-9	1-1/2"	SLB Threaded	Grey	Grey	10	10
505V	75030-3	2"	SLB Threaded	Grey	Grey	4	5.5
Boxed							
503-XL	71035-2	1-1/4"	XLSLB Threaded	Grey	Grey	5	6
505-XL	71040-6	2"	XLSLB Threaded	Grey	Grey	5	14

Type LR – Combo both Threaded and Set Screw Aluminum Conduit Bodies

For rigid or thinwall (EMT) conduit

BWF#	Unit UPC 0-87115	Conduit Size	Type	Description	Color	Case Qty.	Case Weight
Show Pak							
D100V	19102-1	1/2"	LR Threaded	Grey	Grey	27	7
D101V	19103-8	3/4"	LR Threaded	Grey	Grey	15	7.5
D102V	19104-5	1"	LR Threaded	Grey	Grey	14	9
D103V	19119-9	1-1/4"	LR Threaded	Grey	Grey	4	5.5
D104V	19132-8	1-1/2"	LR Threaded	Grey	Grey	4	6
D105V	19133-5	2"	LR Threaded	Grey	Grey	2	5.5

Type LR – Set Screw Aluminum Conduit Bodies

For thinwall (EMT) conduit

BWF#	Unit UPC 0-87115	Conduit Size	Type	Description	Color	Case Qty.	Case Weight
Show Pak							
10V	28333-7	1/2"	LR Set Screw	Grey	Grey	27	7
11V	28334-4	3/4"	LR Set Screw	Grey	Grey	15	7.5
12V	28335-1	1"	LR Set Screw	Grey	Grey	14	9
13V	28336-8	1-1/4"	LR Set Screw	Grey	Grey	4	5.5
14V	28337-5	1-1/2"	LR Set Screw	Grey	Grey	4	6
15V	28338-2	2"	LR Set Screw	Grey	Grey	2	5.5
Boxed							
16	19138-0	2-1/2"	LR Set Screw	Grey	Grey	1	5
17	19139-7	3"	LR Set Screw	Grey	Grey	1	6
18	19140-3	3-1/2"	LR Set Screw	Grey	Grey	1	10
19	19141-0	4"	LR Set Screw	Grey	Grey	1	9

CONDUIT BODIES – DIE CAST METAL

Type LR – Threaded Aluminum Conduit Bodies

For rigid conduit

BWF#	Unit UPC 0-87115	Conduit Size	Type	Description	Color	Case Qty.	Case Weight
Show Pak							
100V	28366-5	1/2"	LR Threaded	Grey	27	7	
101V	28367-2	3/4"	LR Threaded	Grey	15	7.5	
102V	28368-9	1"	LR Threaded	Grey	14	9	
103V	28369-6	1-1/4"	LR Threaded	Grey	4	5.5	
104V	28370-2	1-1/2"	LR Threaded	Grey	4	6	
105V	28371-9	2"	LR Threaded	Grey	2	5.5	
Boxed							
106	71240-0	2-1/2"	LR Threaded	Grey	1	5	
107	71245-5	3"	LR Threaded	Grey	1	6	
108	71250-9	3-1/2"	LR Threaded	Grey	1	10	
109	71255-4	4"	LR Threaded	Grey	1	9	



100V

Type LL – Combo bothThreaded and Set Screw Aluminum Conduit Bodies

For rigid or thinwall (EMT) conduit

BWF#	Unit UPC 0-87115	Conduit Size	Type	Description	Color	Case Qty.	Case Weight
Show Pak							
D200V	19152-6	1/2"	LL Threaded	Grey	27	7	
D201V	19153-3	3/4"	LL Threaded	Grey	15	7.5	
D202V	19154-0	1"	LL Threaded	Grey	14	9	
D203V	19157-1	1-1/4"	LL Threaded	Grey	4	5.5	
D204V	19158-8	1-1/2"	LL Threaded	Grey	4	6	
D205V	19159-5	2"	LL Threaded	Grey	2	5.5	



D200V

Type LL – Set Screw Aluminum Conduit Bodies

For thinwall (EMT) conduit

BWF#	Unit UPC 0-87115	Conduit Size	Type	Description	Color	Case Qty.	Case Weight
Show Pak							
20V	28339-9	1/2"	LL Set Screw	Grey	27	7	
21V	28340-5	3/4"	LL Set Screw	Grey	15	7.5	
22V	28341-2	1"	LL Set Screw	Grey	14	9	
23V	28342-9	1-1/4"	LL Set Screw	Grey	4	5.5	
24V	28343-6	1-1/2"	LL Set Screw	Grey	4	6	
25V	28439-6	2"	LL Set Screw	Grey		5.5	
Boxed							
26	19146-5	2-1/2"	LL Set Screw	Grey	1	5	
27	19147-2	3"	LL Set Screw	Grey	1	6	
28	19148-9	3-1/2"	LL Set Screw	Grey	1	10	
29	19149-6	4"	LL Set Screw	Grey	1	9	



20V

CONDUIT BODIES – DIE CAST METAL

Type LL – Threaded Aluminum Conduit Bodies

For rigid conduit

BWF#	Unit UPC 0-87115	Conduit Size	Type	Description	Color	Case Qty.	Case Weight
Show Pak							
200V	28372-6	1/2"	LL Threaded	Grey	27	7	
201V	28373-3	3/4"	LL Threaded	Grey	15	7.5	
202V	28374-0	1"	LL Threaded	Grey	14	9	
203V	28375-7	1-1/4"	LL Threaded	Grey	4	5.5	
204V	28376-4	1-1/2"	LL Threaded	Grey	4	6	
205V	28477-1	2"	LL Threaded	Grey	2	5.5	
Boxed							
206	71435-0	2-1/2"	LL Threaded	Grey	1	5	
207	71440-4	3"	LL Threaded	Grey	1	6	
208	71445-9	3-1/2"	LL Threaded	Grey	1	10	
209	71450-3	4"	LL Threaded	Grey	1	9	



200V

Type C – Combo both Threaded and Set Screw Aluminum Conduit Bodies

For rigid or thinwall (EMT) conduit

BWF#	Unit UPC 0-87115	Conduit Size	Type	Description	Color	Case Qty.	Case Weight
Show Pak							
D300V	19511-1	1/2"	C Threaded	Grey	24	6.5	
D301V	19512-8	3/4"	C Threaded	Grey	18	7.5	
D302V	19513-5	1"	C Threaded	Grey	14	9	
D303V	19514-2	1-1/4"	C Threaded	Grey	8	12	
D304V	19523-4	1-1/2"	C Threaded	Grey	8	11	
D305V	19524-1	2"	C Threaded	Grey	2	5	



D300V

Type C – Threaded Aluminum Conduit Bodies

For rigid conduit

BWF#	Unit UPC 0-87115	Conduit Size	Type	Description	Color	Case Qty.	Case Weight
Show Pak							
300V	28378-8	1/2"	C Threaded	Grey	24	6.5	
301V	28379-5	3/4"	C Threaded	Grey	18	7.5	
302V	28380-1	1"	C Threaded	Grey	14	9	
303V	28381-8	1-1/4"	C Threaded	Grey	8	12	
304V	28382-5	1-1/2"	C Threaded	Grey	8	11	
305V	28383-2	2"	C Threaded	Grey	2	5	
Boxed							
306	71535-7	2-1/2"	C Threaded	Grey	1	6.5	
307	71540-1	3"	C Threaded	Grey	1	7.5	
308	71545-6	3-1/2"	C Threaded	Grey	1	9	
309	71550-0	4"	C Threaded	Grey	1	12	



300V

CONDUIT BODIES – DIE CAST METAL

Type C – Set Screw Aluminum Conduit Bodies

For thinwall (EMT) conduit

BWF#	Unit UPC 0-87115	Conduit Size	Type	Description	Color	Case Qty.	Case Weight
Show Pak							
30V	28344-3	1/2"	C Set Screw	Grey	Grey	24	6.5
31V	28345-0	3/4"	C Set Screw	Grey	Grey	18	7.5
32V	28346-7	1"	C Set Screw	Grey	Grey	14	9
33V	28347-4	1-1/4"	C Set Screw	Grey	Grey	8	12
34V	28348-1	1-1/2"	C Set Screw	Grey	Grey	8	11
35V	28349-8	2"	C Set Screw	Grey	Grey	2	5
Boxed							
36	19535-7	2-1/2"	C Set Screw	Grey	Grey	1	6.5
37	19536-4	3"	C Set Screw	Grey	Grey	1	7.5
38	19537-1	3-1/2"	C Set Screw	Grey	Grey	1	9
39	19538-8	4"	C Set Screw	Grey	Grey	1	12



30V

Type LB – Combo both Threaded and Set Screw Aluminum Conduit Bodies

For rigid or thinwall (EMT) conduit

BWF#	Unit UPC 0-87115	Conduit Size	Type	Description	Color	Case Qty.	Case Weight
Show Pak							
D600V	19531-9	1/2"	LB Threaded	Grey	Grey	30	7
D601V	19532-6	3/4"	LB Threaded	Grey	Grey	18	7.5
D602V	19533-3	1"	LB Threaded	Grey	Grey	16	9
D603V	19534-0	1-1/4"	LB Threaded	Grey	Grey	8	5.5
D604V	19541-8	1-1/2"	LB Threaded	Grey	Grey	8	6
D605V	19542-5	2"	LB Threaded	Grey	Grey	2	5.5



D600V

Type LB – Threaded Aluminum Conduit Bodies

For rigid conduit

BWF#	Unit UPC 0-87115	Conduit Size	Type	Description	Color	Case Qty.	Case Weight
Show Pak							
600V	28384-9	1/2"	LB Threaded	Grey	Grey	24	7
601V	28385-6	3/4"	LB Threaded	Grey	Grey	18	7.5
602V	28386-3	1"	LB Threaded	Grey	Grey	16	9
603V	28387-0	1-1/4"	LB Threaded	Grey	Grey	8	5.5
604V	28388-7	1-1/2"	LB Threaded	Grey	Grey	8	6
605V	28389-4	2"	LB Threaded	Grey	Grey	2	5.5
Boxed							
606	71135-9	2-1/2"	LB Threaded	Grey	Grey	1	5
607	71140-3	3"	LB Threaded	Grey	Grey	1	5
608	71145-8	3-1/2"	LB Threaded	Grey	Grey	1	9.5
609	71150-2	4"	LB Threaded	Grey	Grey	1	8.5



600V

CONDUIT BODIES – DIE CAST METAL

Type LB – Set Screw Aluminum Conduit Bodies

For thinwall (EMT) conduit

BWF#	Unit UPC 0-87115	Conduit Size	Type	Description	Color	Case Qty.	Case Weight
Show Pak							
60V	28350-4	1/2"	LB Set Screw	Grey	Grey	24	7
61V	28351-1	3/4"	LB Set Screw	Grey	Grey	18	7.5
62V	28352-8	1"	LB Set Screw	Grey	Grey	16	9
63V	28353-5	1-1/4"	LB Set Screw	Grey	Grey	8	5.5
64V	28354-2	1-1/2"	LB Set Screw	Grey	Grey	8	6
65V	28355-9	2"	LB Set Screw	Grey	Grey	2	5.5
Boxed							
66	71735-1	2-1/2"	LB Set Screw	Grey	Grey	1	4.5
67	71740-5	3"	LB Set Screw	Grey	Grey	1	5
68	71745-0	3-1/2"	LB Set Screw	Grey	Grey	1	9.5
69	71750-4	4"	LB Set Screw	Grey	Grey	1	8.5



60V

Type T – Combo both Threaded and Set Screw Aluminum Conduit Bodies

For rigid or thinwall (EMT) conduit

BWF#	Unit UPC 0-87115	Conduit Size	Type	Description	Color	Case Qty.	Case Weight
Show Pak							
D700V	19543-2	1/2"	T Threaded	Grey	Grey	16	5
D701V	19544-6	3/4"	T Threaded	Grey	Grey	12	5.5
D702V	19546-3	1"	T Threaded	Grey	Grey	14	9
D703V	19547-0	1-1/4"	T Threaded	Grey	Grey	4	7.5
D704V	19548-7	1-1/2"	T Threaded	Grey	Grey	4	6.5
D705V	19549-4	2"	T Threaded	Grey	Grey	2	5.5



D700V

Type T – Threaded Aluminum Conduit Bodies

For rigid conduit

BWF#	Unit UPC 0-87115	Conduit Size	Type	Description	Color	Case Qty.	Case Weight
Show Pak							
700V	28390-0	1/2"	T Threaded	Grey	Grey	16	5
701V	28391-7	3/4"	T Threaded	Grey	Grey	14	5.5
702V	28392-4	1"	T Threaded	Grey	Grey	12	9
703V	28393-1	1-1/4"	T Threaded	Grey	Grey	4	7.5
704V	28394-8	1-1/2"	T Threaded	Grey	Grey	4	6.5
705V	28395-8	2"	T Threaded	Grey	Grey	2	5.5
Boxed							
706	71635-4	2-1/2"	T Threaded	Grey	Grey	1	5.5
707	71640-8	3"	T Threaded	Grey	Grey	1	6.5
708	71645-3	3-1/2"	T Threaded	Grey	Grey	1	10
709	71650-7	4"	T Threaded	Grey	Grey	1	9



700V

CONDUIT BODIES – DIE CAST METAL

Type T – Set Screw Aluminum Conduit Bodies

For thinwall (EMT) conduit

BWF#	Unit UPC 0-87115	Conduit Size	Type	Description	Color	Case Qty.	Case Weight
Show Pak							
70V	28360-3	1/2"	T Set Screw	Grey	Grey	16	5
71V	28361-0	3/4"	T Set Screw	Grey	Grey	14	5.5
72V	28362-7	1"	T Set Screw	Grey	Grey	12	9
73V	28363-4	1-1/4"	T Set Screw	Grey	Grey	4	7.5
74V	28364-1	1-1/2"	T Set Screw	Grey	Grey	4	6.5
75V	28365-8	2"	T Set Screw	Grey	Grey	2	5.5
Boxed							
76	19558-6	2-1/2"	T Set Screw	Grey	Grey	1	5.5
77	19559-3	3"	T Set Screw	Grey	Grey	1	6.5
78	19560-9	3-1/2"	T Set Screw	Grey	Grey	1	10
79	19561-6	4"	T Set Screw	Grey	Grey	1	9



70V

CONDUIT BODY COVERS – STAMPED & DIE CAST METAL

Stamped Aluminum Conduit Body Covers

Screws included



SC-1V



DC-1V

BWF#	Unit UPC 0-87115	Conduit Size	Type	Description	Color	Case Qty.	Case Weight
Show Pak							
SC-1V	31161-0	1/2"	Stamped		Grey	100	5.5
SC-2V	31162-7	3/4"	Stamped		Grey	100	7
SC-3V	31163-4	1"	Stamped		Grey	50	8
SC-4V	31164-1	1-1/4" - 1-1/2"	Stamped		Grey	50	8.5
SC-5V	31165-8	2"	Stamped		Grey	25	7
Boxed							
SC-1	73105-0	1/2"	Stamped		Grey	250	14.5
SC-2	73110-4	3/4"	Stamped		Grey	250	18.5
SC-3	73115-9	1"	Stamped		Grey	250	23
SC-4	73120-3	1-1/4" - 1-1/2"	Stamped		Grey	50	8.5
SC-5	73130-2	2"	Stamped		Grey	75	21
Show Pak							
DC-1V	28497-6	1/2"	Die Cast		Grey	100	7
DC-2V	28498-3	3/4"	Die Cast		Grey	50	4.5
DC-3V	28499-0	1"	Die Cast		Grey	50	6
DC-4V	28500-3	1-1/4" - 1-1/2"	Die Cast		Grey	50	8.5
DC-5V	31150-4	2"	Die Cast		Grey	25	10
Boxed							
DC-1	72805-0	1/2"	Die Cast		Grey	250	15
DC-2	72810-4	3/4"	Die Cast		Grey	250	30
DC-3	72815-9	1"	Die Cast		Grey	250	37
DC-4	72820-3	1-1/4" - 1-1/2"	Die Cast		Grey	50	13
DC-5	72825-8	2"	Die Cast		Grey	75	34
DC-6	72835-7	2-1/2" - 3"	Die Cast		Grey	10	8
DC-7	72840-1	3-1/2" - 4"	Die Cast		Grey	5	7

CONDUIT BODY COVERS – STAMPED & DIE CAST METAL

Standard Conduit Body Gaskets – Fiber & Neoprene

BWF#	Unit UPC 0-87115	Conduit Size	Type	Description	Color	Case Qty.	Case Weight
Show Pak							
FG-1V	31151-1	1/2"	Fiber	Fiber	Grey	500	3
FG-2V	31152-8	3/4"	Fiber	Fiber	Grey	500	4
FG-3V	31153-5	1"	Fiber	Fiber	Grey	500	5
FG-4V	31154-2	1-1/4" – 1-1/2"	Fiber	Fiber	Grey	200	6
FG-5V	31155-9	2"	Fiber	Fiber	Grey	100	4
Boxed							
FG-1	25007-0	1/2"	Fiber	Fiber	Grey	2500	14
FG-2	28409-9	3/4"	Fiber	Fiber	Grey	1000	8
FG-3	28410-5	1"	Fiber	Fiber	Grey	500	7
FG-4	28411-2	1-1/4" – 1-1/2"	Fiber	Fiber	Grey	500	9.5
FG-5	28413-6	2"	Fiber	Fiber	Grey	125	6
FG-6	28414-3	2-1/2" – 3"	Fiber	Fiber	Grey	50	4
FG-7	25016-2	3-1/2" – 4"	Fiber	Fiber	Grey	10	1
Show Pak							
NG-1V	31156-6	1/2"	Neoprene	Neoprene	Grey	500	9
NG-2V	31157-3	3/4"	Neoprene	Neoprene	Grey	500	10
NG-3V	31158-0	1"	Neoprene	Neoprene	Grey	500	13
NG-4V	31159-7	1-1/4" – 1-1/2"	Neoprene	Neoprene	Grey	200	11.5
NG-5V	31160-3	2"	Neoprene	Neoprene	Grey	100	8.5
Boxed							
NG-1	33627-9	1/2"	Neoprene	Neoprene	Grey	2500	27
NG-2	33628-6	3/4"	Neoprene	Neoprene	Grey	1000	13
NG-3	33629-3	1"	Neoprene	Neoprene	Grey	500	11
NG-4	33626-2	1-1/4" – 1-1/2"	Neoprene	Neoprene	Grey	500	19.5
NG-5	33630-9	2"	Neoprene	Neoprene	Grey	125	11
NG-6	33631-6	2-1/2" – 3"	Neoprene	Neoprene	Grey	50	9
NG-7	33632-3	3-1/2" – 4"	Neoprene	Neoprene	Grey	10	2



FG-1V



NG-1V

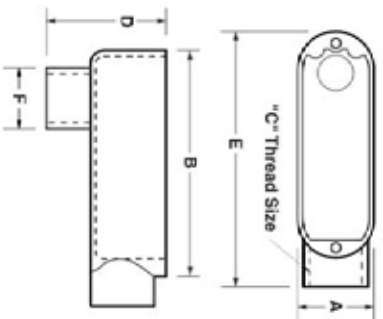

Type LB Dimensions - Threaded & Set Screw

Conduit Size	A	B	C	D	E	F
1/2"	1-11/32"	15-7/64"	1/2"	2-11/64"	4-13/32"	1-5/32"
3/4"	1-35/64"	4-49/64"	3/4"	2-7/16"	5-1/8"	1-3/8"
1"	1-3/4"	5-3/8"	1"	2-3/4"	5-15/16"	1-23/32"
1-1/4"	2-35/64"	7-15/64"	1-1/4"	3-35/64"	7-7/8"	2-15/64"
1-1/2"	2-19/32"	7-17/64"	1-1/2"	3-23/32"	7-7/8"	2-3/8"
2"	3-13/64"	9-33/64"	2"	4-1/4"	10-15/64"	2-29/32"
2-1/2"	4-1/2"	12-3/16"	2-1/2"	5-5/32"	12-3/4"	3-13/32"
3"	4-15/32"	12-17/64"	3"	5-21/32"	12-43/64"	4-1/64"
3-1/2"	5-39/64"	5-1/32"	3-1/2"	6-61/64"	15-35/64"	5-5/32"
4"	5-39/64"	15-1/32"	4"	6-61/64"	15-35/64"	5-5/32"

Type LB Dimensions - Threaded & Set Screw

Conduit Size	A	B	C	D	E	F
1/2"	1-5/16"	3-27/32"	1/2"	1-1/2"	4-27/32"	1-1/8"
3/4"	1-17/32"	4-19/32"	3/4"	1-5/8"	5-41/64"	1-5/16"
1"	1-3/4"	5-11/32"	1"	1-29/32"	6-1/2"	1-1/2"
1-1/4"	2-17/32"	7-1/4"	1-1/4"	2-3/4"	8-1/2"	2-1/4"
1-1/2"	2-17/32"	7-1/4"	1-1/2"	2-3/4"	8-1/2"	2-1/4"
2"	2-7/32"	9-7/16"	2"	3-13/32"	10-3/4"	2-3/4"
2-1/2"	4-1/2"	12-1/4"	2-1/2"	4-1/2"	13"	4-1/2"
3"	4-1/2"	12-1/4"	3"	4-1/2"	13"	4-1/2"
3-1/2"	5-1/2"	15"	3-1/2"	5-9/16"	16-5/16"	5-1/2"
4"	5-1/2"	15"	4"	5-9/16"	16-5/16"	5-1/2"

Type LL Dimensions - Threaded & Set Screw

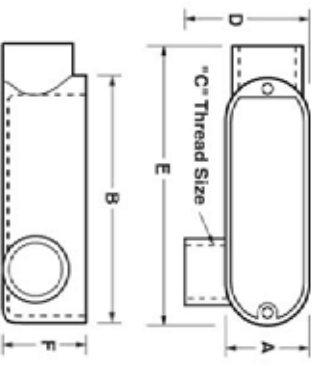

Conduit Size	A	B	C	D	E	F
1/2"	1-3/32"	3-7/8"	1/2"	2"	4-9/32"	1-13/32"
3/4"	1-1/4"	4-21/32"	3/4"	2-11/32"	5-1/8"	1-13/32"
1"	1-1/2"	5-23/64"	1"	2-1/2"	5-59/64"	1-7/8"
1-1/4"	2-1/4"	7-17/64"	1-1/4"	3-13/32"	7-55/64"	2-7/8"
1-1/2"	2-1/4"	7-17/64"	1-1/2"	3-13/32"	7-55/64"	2-7/8"
2"	2-3/4"	9-15/32"	2"	3-27/32"	10-13/64"	3-27/64"
2-1/2"	4-5/8"	12-1/4"	2-1/2"	5-3/4"	13"	4-1/2"
3"	4-5/8"	12-1/4"	3"	5-3/4"	13"	4-1/2"
3-1/2"	5-7/16"	15"	3-1/2"	6-1/8"	16-5/16"	5-9/16"
4"	5-7/16"	15"	4"	6-1/8"	16-5/16"	5-9/16"

Type LR Dimensions - Threaded & Set Screw

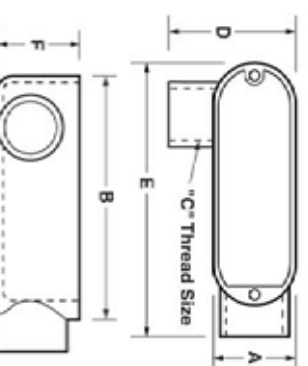

Conduit Size	A	B	C	D	E	F
1/2"	1-7/64"	3-7/8"	1/2"	2"	4-9/32"	1-13/32"
3/4"	1-1/4"	4-21/32"	3/4"	2-11/32"	5-1/8"	1-41/64"
1"	1-1/2"	5-23/64"	1"	2-1/2"	5-59/64"	1-7/8"
1-1/4"	2-1/4"	7-17/64"	1-1/4"	3-13/32"	7-55/64"	2-7/8"
1-1/2"	2-1/4"	7-17/64"	1-1/2"	3-13/32"	7-55/64"	2-7/8"
2"	2-3/4"	9-15/32"	2"	3-27/32"	10-13/64"	3-27/64"
2-1/2"	4-7/16"	12-1/4"	2-1/2"	5-13/16"	12-1/4"	4-1/2"
3"	4-5/8"	12-1/4"	3"	5-13/16"	12-1/4"	4-1/2"
3-1/2"	5-7/16"	15"	3-1/2"	6-1/8"	15"	6-1/4"
4"	5-7/16"	15"	4"	6-1/8"	15"	6-1/4"

Type T Dimensions - Threaded & Set Screw

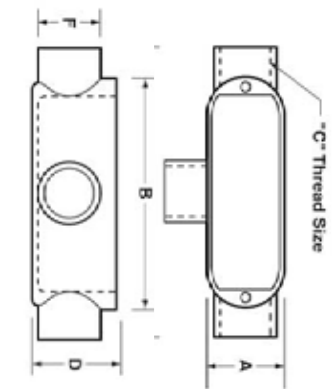

Conduit Size	A	B	C	D	E	F
1/2"	1-5/16"	3-27/32"	1/2"	1-3/8"	4-27/32"	2-1/16"
3/4"	1-17/16"	4-39/64"	3/4"	1-41/64"	5-19/32"	2-11/32"
1"	1-25/32"	5-3/8"	1"	1-29/32"	6-1/2"	2-19/32"
1-1/4"	2-1/2"	7-1/4"	1-1/4"	2-3/4"	8-1/2"	3-35/64"
1-1/2"	2-1/2"	7-1/4"	1-1/2"	2-3/4"	8-1/2"	3-35/64"
2"	3-1/4"	9-7/16"	2"	3-27/64"	10-13/16"	4-3/64"
2-1/2"	4-1/2"	12-1/4"	2-1/2"	4-1/2"	13"	5-25/32"
3"	4-1/2"	12-1/4"	3"	4-1/2"	13"	5-25/32"
3-1/2"	5-1/2"	15"	3-1/2"	5-9/16"	16-5/16"	6-13/16"
4"	5-1/2"	15"	4"	5-9/16"	16-5/16"	6-13/16"

SERVICE ENTRANCE HEADS & ELECTRICAL FITTINGS

Service Entrance Heads – Clamp Types

BWF#	Unit UPC 0-87115	Pipe Size	Type	Description	Color	Case Qty.	Case Weight
Show Pak							
180V	75905-4	1/2"	Clamp	Clamp	Grey	25	12
181V	75910-8	3/4"	Clamp	Clamp	Grey	20	11.5
182V	75915-3	1"	Clamp	Clamp	Grey	20	8
183V	75920-7	1-1/4"	Clamp	Clamp	Grey	10	5.5
184V	75925-2	1-1/2"	Clamp	Clamp	Grey	8	7
185V	75930-6	2"	Clamp	Clamp	Grey	3	5
Boxed							
1866	70935-6	2-1/2"	Clamp	Clamp	Grey	1	4.5
2877	70932-5	3"	Clamp	Clamp	Grey	1	7
2888	70945-5	3-1/2"	Clamp	Clamp	Grey	1	6.5
2899	70950-9	4"	Clamp	Clamp	Grey	1	6.5



180V



270



271



360



236

Service Entrance Cable Fittings

BWF#	Unit UPC 0-87115	Pipe Size	Type	Description	Color	Case Qty.	Case Weight
Boxed							
270	70005-6	3/4"	Clamp	Clamp	Grey	250	32
271	70010-0	1"	Clamp	Clamp	Grey	200	35
372	70015-5	1-1/4"	Clamp	Clamp	Grey	150	44
373	70020-9	1-1/2"	Clamp	Clamp	Grey	100	31.5
374	70025-4	2"	Clamp	Clamp	Grey	100	44.5

90° Angle Connectors

BWF#	Unit UPC 0-87115	Pipe Size	Type	Description	Color	Case Qty.	Case Weight
Boxed							
265	70105-3	3/8"	90°	90°	Grey	250	31.5
268	70110-7	1/2"	90°	90°	Grey	200	39.5
269	70115-2	3/4"	90°	90°	Grey	150	46.5
360	70120-6	1"	90°	90°	Grey	75	40
361	70125-1	1-1/4"	90°	90°	Grey	50	37.5
362	70126-8	1-1/2"	90°	90°	Grey	10	10
363	70127-5	2"	90°	90°	Grey	5	5.5

EMT Connectors – Set Screw Type

BWF#	Unit UPC 0-87115	Pipe Size	Type	Description	Color	Case Qty.	Case Weight
Boxed							
233	70202-9	1-1/4"	Set Screw	Set Screw	Grey	35	6.5
234	70203-6	1-1/2"	Set Screw	Set Screw	Grey	35	8
235	70204-3	2"	Set Screw	Set Screw	Grey	20	9
236	70205-0	2-1/2"	Set Screw	Set Screw	Grey	12	10
237	70210-4	3"	Set Screw	Set Screw	Grey	12	13
238	70215-9	3-1/2"	Set Screw	Set Screw	Grey	10	7.5
239	70220-3	4"	Set Screw	Set Screw	Grey	6	9.5



ELECTRICAL FITTINGS

EMT Couplings – Set Screw Type

Set screws included



246

BWF#	Unit UPC 0-87115	Pipe Size	Type	Description	Color	Case Qty.	Case Weight
Show Pak							
243	70302-6	1-1/4"	Set Screw	Set Screw	Grey	25	6.5
244	70303-3	1-1/2"	Set Screw	Set Screw	Grey	25	7.5
245	70304-0	2"	Set Screw	Set Screw	Grey	20	8
246	70305-7	2-1/2"	Set Screw	Set Screw	Grey	12	12
247	70310-1	3"	Set Screw	Set Screw	Grey	12	12.5
248	70315-6	3-1/2"	Set Screw	Set Screw	Grey	6	8
249	70320-0	4"	Set Screw	Set Screw	Grey	6	9

Insulated Bushing



171

BWF#	Unit UPC 0-87115	Pipe Size	Type	Description	Color	Case Qty.	Case Weight
Boxed							
171	09003-4	1/2"	Insulated	Insulated	Grey	1000	6.5
172	70710-9	3/4"	Insulated	Insulated	Grey	1000	8
173	70715-4	1"	Insulated	Insulated	Grey	500	7.5
174	70720-8	1-1/4"	Insulated	Insulated	Grey	250	6
175	70725-3	1-1/2"	Insulated	Insulated	Grey	250	6.5
176	70730-7	2"	Insulated	Insulated	Grey	125	5
177	70735-2	2-1/2"	Insulated	Insulated	Grey	100	6.5
178	70740-6	3"	Insulated	Insulated	Grey	50	5
179	70745-1	3-1/2"	Insulated	Insulated	Grey	50	6
170	70750-5	4"	Insulated	Insulated	Grey	50	6

Steel Lock Nuts



131

BWF#	Unit UPC 0-87115	Pipe Size	Type	Description	Color	Case Qty.	Case Weight
Boxed							
131	70805-2	3/8"	Steel	Steel	Grey	2500	44
132	70810-6	1/2"	Steel	Steel	Grey	2500	33.5
133	70815-1	3/4"	Steel	Steel	Grey	2500	48
134	70820-5	1"	Steel	Steel	Grey	1000	33.5
149	70825-0	1-1/4"	Steel	Steel	Grey	500	27
150	70830-4	1-1/2"	Steel	Steel	Grey	500	26.5
151	70835-9	2"	Steel	Steel	Grey	400	29
152	70840-3	2-1/2"	Steel	Steel	Grey	300	39.5
153	70845-8	3"	Steel	Steel	Grey	250	44.5
154	70850-2	3-1/2"	Steel	Steel	Grey	125	27.5
155	70855-7	4"	Steel	Steel	Grey	100	27.5
156	70860-1	5"	Steel	Steel	Grey	30	23.5
157	70865-6	6"	Steel	Steel	Grey	30	26.5

Ground Fittings

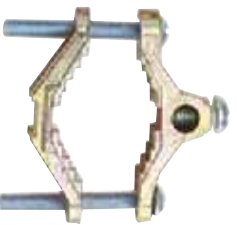

L-162

BWF#	Unit UPC 0-87115	Pipe Size	Type	Description	Color	Case Qty.	Case Weight
Boxed							
L-162C	73205-7	1/2" - 1-1/4"	#4 -#10 AWG	Zinc	Zinc	250	43
L-162-B	73210-1	1/2" - 1-1/4"	Grounding wire	Brass	Brass	250	43
L-163C	73215-6	1/2" - 1-1/4"	#4 -#8 AWG	Zinc	Zinc	250	50
L-163B	73220-0	1/2" - 1-1/4"	Bare armored wire	Brass	Brass	250	50



REPLACEMENT PARTS & ACCESSORIES

BWF#	Unit UPC 0-87115	Description	Color	Case Qty.	Case Weight
Boxed					
GS	37015-0	Self Tap GRD Screw, #8-3/2, 1/4"	Green	100	.52
SP	37017-4	Spacers for TS-1 & TS-2 covers	Black	100	2
ML	21020-3	2 Mounting Lugs w/screws	Grey	100	1
RS	30030-0	Porcelain Replacement Socket	Grey	25	3
S11	33593-7	Single Pole 10A/125V Switch	Black	50	15
S13	37030-3	Three Way 10A/125V Switch	Black	50	15
S15	37031-0	Single Pole 20A-120V/277V	Black	50	15
Show Pak					
GV	31166-5	2 pk of Internal Lampholder Gasket	Black	600	2
G-1V	41300-0	External Lampholder Gasket	Black	50	3
UBGV	37020-4	Universal 1 Gang Gasket	Black	50pks	2
RGV	37040-2	Universal Round Gasket	Black	50pks	1
BGV	27229-4	1 gang Gasket, Single & Duplex Curs	Black	50pks	1
TGBGV	27230-0	Universal 2 Gang Gasket	Black	50pks	1
GP-6V	30540-4	Gasket Pack, Poly Bagged	Black	20	2
PL-5/4V	05400-5	4 - 1/2" Closure Plugs	Grey	75pks	6
PL-5/4AV	05403-6	4 - 1/2" Closure Plugs	Bronze	75pks	6
PL-5/4WV	05402-9	4 - 1/2" Closure Plugs	White	75pks	6
PL-7/5/4V	21012-8	4 - 3/4" Closure Plugs	Grey	50/pks	6
PL-7/5/4AV	27220-1	4 - 3/4" Closure Plugs	Bronze	50/pks	6
PL-7/5/4WV	27221-8	4 - 3/4" Closure Plugs	White	50/pks	6
PL/7/5/4BV	27222-5	4 - 3/4" Closure Plugs	Black	50/pks	6
PL/10/4V	27223-2	4 - 1" Closure Plugs	Grey	50/pks	9
PL/10/4AV	27224-9	4 - 1" Closure Plugs	Bronze	50/pks	9
PL/10/4WV	27225-6	4 - 1" Closure Plugs	White	50/pks	9
PL/10/4BV	27226-3	4 - 1" Closure Plugs	Black	50/pks	9
Blister Carded					
50AP-1	05012-0	3 - 1/2" Plugs, 2 Wire Nuts	Grey	12	1
50APAB-1	05016-8	3 - 1/2" Plugs, 2 Wire Nuts	Bronze	12	1
50APW-1	50195-0	3 - 1/2" Plugs, 2 Wire Nuts	White	12	1
75AP-1	07512-3	3 - 3/4" Plugs, 2 Wire Nuts	Grey	12	1.5
75APAB-1	07516-1	3 - 3/4" Plugs, 2 Wire Nuts	Bronze	12	1.5
75APW-1	50200-1	3 - 3/4" Plugs, 2 Wire Nuts	White	12	1.5
75APB-1	07515-4	3 - 3/4" Plugs, 2 Wire Nuts	Black	12	1.5

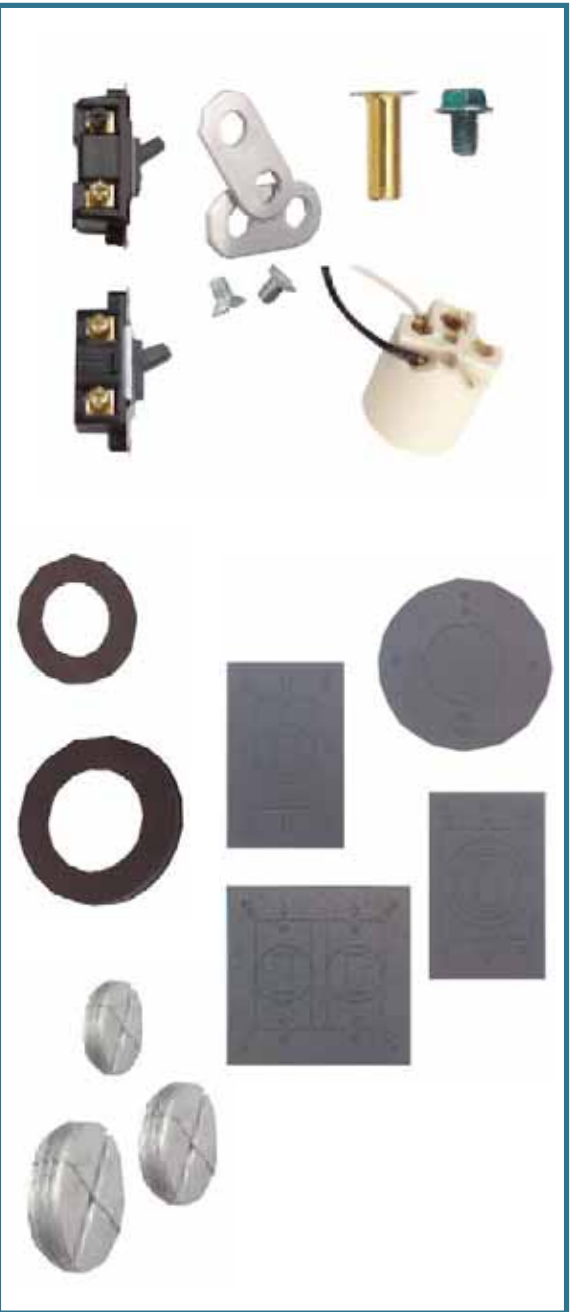

NOTES

NOTES



TEDDICO
ELECTRICAL PRODUCTS



*A Leading Manufacturer of
Weatherproof Electrical Products*

1104 Parkway View Drive
Pittsburgh, PA 15205
412-747-4970
Fax: 412-747-4973

www.teddicobwf.com