

**2011  
Edition**

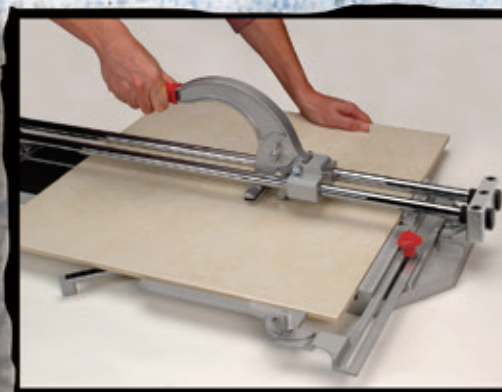

# **'Tile & Stone Installation TOOL CATALOG**



**PROFESSIONAL  
SOLUTIONS for the  
FLOORING INDUSTRY**



# FULL PRODUCT LINE SOLUTIONS

Since 1979, Q.E.P. Co., Inc has been a driving force in the continued growth and **modernization** of flooring installation techniques and tools. As a **world leader** in the design and manufacture of **quality** flooring tools and accessories, our commitment to **innovation** and customer service has positioned QEP as the **benchmark** to how all other flooring tools are measured. QEP continues to introduce **innovative** new products that address the challenges of today's market.

Our products, from the do-it-yourself line to professional installer grade, can be found in all 50 states and in over 75 countries worldwide. We have strategically located facilities across North America, as well as across the globe, to better serve our customers' needs. These global facilities help us stay "local" to our 3,000+ distributors in order to keep shipping lead times as short as possible.

At QEP, our first priority is service to you, our valued customer.

## Brutus

### BRAND TOOLS

- The name in professional tiling tools.



### BRAND TOOLS

- Affordable tiling tools for projects of all sizes.



## Vitrex

The professional way to do it yourself

### BRAND TOOLS

- The perfect tile tool brand for small retailers.



# TABLE OF CONTENTS

## Tile & Stone Installation Products

### Tile Saws & Diamond Blades

Bridge Saws, Tile Saws, Table Top Saws, Diamond Blades, Profile Wheels, Water Pumps

2-12

### Power Tools & Accessories

Jamb Saws, Handheld Tile Saw, Mixers, Paddles, Drill Bits, Hole Saws

13-16

### Tile Cutting Tools

Tile Cutters, Replacement Wheels, Nippers, Pliers, Marking Tools, Hand Saws, Files

17-22

### Tile Installation Tools

Scrapers, Trowels, Spacers, Gloves, Knee Pads, Sponges, Floats, Kits, Grout Removers

23-34

### Vitrex® Brand Tools

The professional way to do it yourself

## Building & Flooring Installation Tools

Tape, Laminate Tools, Brick Installation, Cement Board Installation

35-38

## Underlayment & Surface Protection

39-41

## Suspend-It® Ceiling Installation Tools

• DROP CEILING INSTALLATION •

49-51

World Class... World Wide

# Tile Saws

## 40" Bridge Saw

83240

**ONE YEAR LIMITED WARRANTY**

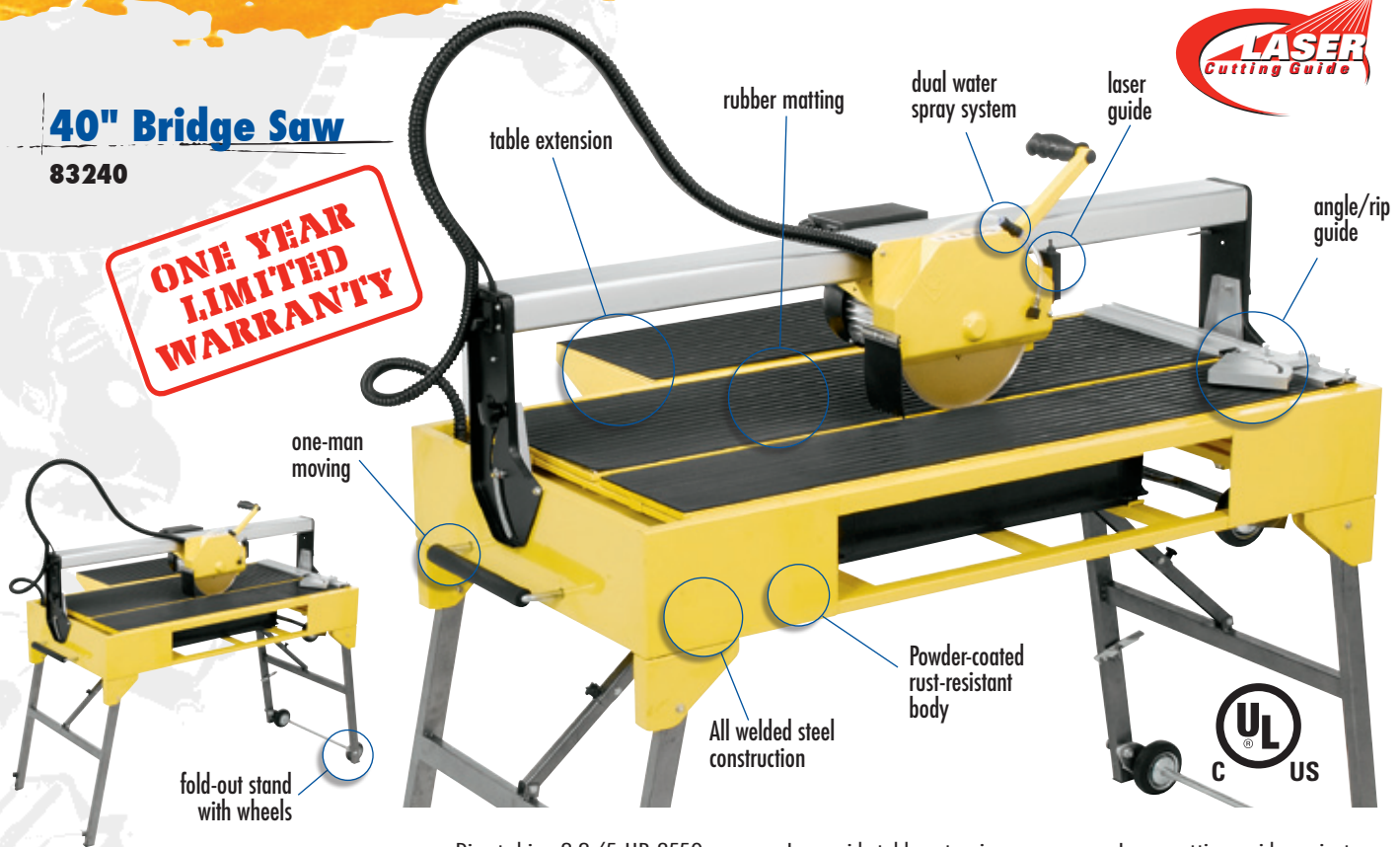

adjustable pivoting rail

- Direct drive 2-2/5 HP, 3550 RPM brushless motor is ideal for cutting large format marble, granite, porcelain, stone and tile\*
- 6 ball-bearing cutting assembly allows motor to glide smoothly with minimal vibration for precise cuts
- Completely enclosed dual water spray system evenly distributes water flow, extending the life of the diamond blade
- Rips up to a 40" tile and can diagonally cut a 28" tile
- Large side-table extension provides extra support for large format tiles and slabs
- Rubber matted cutting table keeps tiles secure for clean, smooth cuts
- Adjustable pivoting rail allows easy angle positioning from 90° to 45° for fast and consistent miter cuts
- Automatic thermal overload protection prevents tile saw from overheating
- Laser cutting guide projects accurate cutting path
- Fold-out stand with wheels for easy mobility and storage
- Child-proof, locking on/off switch and key provide additional safety
- Power cords are encapsulated in a protective tube and attached to a flexible rod that keeps the cutting table safe and clear
- One year limited warranty

\* for porcelain and hard tiles, we recommend QEP's Black Widow Blade (#6-1008BW)

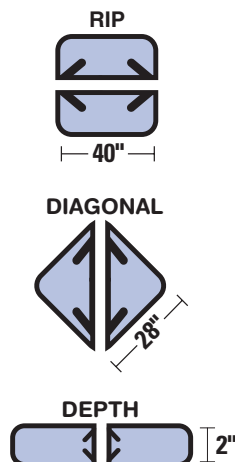

### ACCESSORIES INCLUDED

- Fold-out stand with wheels
- 10" continuous rim wet diamond blade (#6-1003CR)
- High volume water pump (#60098)
- Laser cutting guide (#63025)
- Side extension table
- Angle/rip cutting guide
- Handles

### SPECIFICATIONS

Item No:	83240
Motor:	2-2/5 HP / 120 V - 60 Hz / 15 Amps
Watts:	1800
RPM:	3550
Blade Capacity:	10"
Arbor:	5/8"
Rip Cut:	40" Tile
Diagonal Cut:	28" Tile
Depth of Cut:	2"
Size:	55.5" L x 37.2" W x 48" H (w/stand)
Weight:	163 lbs. (w/stand)

Please see page 10 – 11 for Tile Saw Replacement Blades

1.866.435.8665



## 830Z 30" Professional Bridge Saw

83230

**ONE YEAR LIMITED WARRANTY**

**FREE UPGRADE!**

Premier Black Widow™ Blade for the fast cutting of hard tiles including ceramic, porcelain, marble and granite



Plunge cutting head

Unique draining system



Slide out handle and pop-down wheels for easy transport



pivoting cutting head

- Ideal for cutting large format tile including ceramic, porcelain, granite, stone and marble tile
- Rips up to 30" tile and can diagonally cut up to 22" tile
- Includes high quality Black Widow™ blade for fast cutting of hard tiles including porcelain
- Heavy-duty cutting assembly glides smoothly on 6 ball bearings assuring precision cuts with minimal effort
- Adjustable pivoting rail offers quick and easy 45° to 90° miter cuts
- All power cords are encapsulated in a protective tube and attached to a flexible rod that keeps it clear of the cutting table, while in use
- Dual water tubes for maximum water disbursement to diamond blades increasing the life of the blade and reducing dust
- Rubber matting provides a slip resistant surface for your tile
- Includes child-proof locking switch/key
- Includes automatic thermal overload protection to prevent motor from overheating
- Unique hose coupling allows for easier drainage or fill ups with a garden hose
- Versatile plunge cutting for miter cuts and rip/angle cuts
- One year limited warranty

### SPECIFICATIONS

Item No:	83230
Motor:	10.5 Amps, 1362 Watts
RPM:	3260
Blade Capacity:	8"
Arbor:	5/8"
Rip Cut:	30" Tile
Diagonal Cut:	22" Tile
Depth of Cut:	H/2"
Size:	46.3" L x 19.8" W x 57.5" H (w/stand)
Weight:	121.3 lbs (w/stand)

#### ACCESSORIES INCLUDED

- 8" Black Widow™ diamond blade (6-8008BW)
- Fold-out stand with wheels
- High volume water pump (#60098)
- Laser cutting guide
- Side extension table
- Angle cutting guide
- Slide out handle and extra wheels
- 2 wrenches

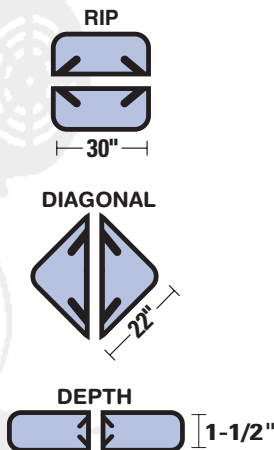

# Tile Saws

## 24" Bridge Saw

83200



convenient handles



storage shelf

fold-out stand w/ wheel attachment



pivoting cutting head

- Direct drive 1-1/2 HP, 3550 RPM brushless motor is ideal for cutting marble, granite, porcelain, stone and tile\*
- 6 ball-bearing cutting assembly allows motor to glide smoothly with minimal vibration for precise cuts
- Completely enclosed dual water spray system evenly distributes water flow, extending the life of the diamond blade
- Rips up to a 24" tile and can diagonally cut a 18" tile
- Adjustable pivoting rail allows easy angle positioning from 90° to 45° for fast and consistent miter cuts
- Angle/rip guide makes production cuts consistent
- Automatic thermal overload protection prevents tile saw from overheating
- Laser cutting guide projects accurate cutting path
- Heavy duty shelf for storage and fast access to tile
- Fold-out stand with wheel attachments for easy mobility and storage
- Child-proof, locking on/off switch and key provide additional safety
- Power cords are encapsulated in a protective tube and attached to a flexible rod that keeps the cutting table safe and clear
- One year limited warranty

\* for porcelain and hard tiles, we recommend QEP's Black Widow (#6-8008BW)

## SPECIFICATIONS

Item No:	83200
Motor:	1/2 HP / 120V-60Hz / 9.2 Amps
Watts:	1100
RPM:	3550
Blade Capacity:	8"
Arbor:	5/8"
Rip Cut:	24" Tile
Diagonal Cut:	18" Tile
Depth of Cut:	1/2"
Size:	37" L x 18" W x 47.5" H (w/stand)
Weight:	82 lbs (w/stand)

### ACCESSORIES INCLUDED

- Fold-out stand with wheel attachments
- Rear wheel attachments (#63036)
- Convenient storage shelf
- 8" continuous rim wet diamond blade (#6-8003CR)
- High volume water pump (#60098)
- Laser cutting guide (#63025)
- Angle/rip cutting guide
- Handles

RIP



24"

DIAGONAL

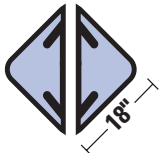

18"

DEPTH



1-1/2"

Please see page 10 – 11 for Tile Saw Replacement Blades



## 24" Dual Speed Tile Saw

60020

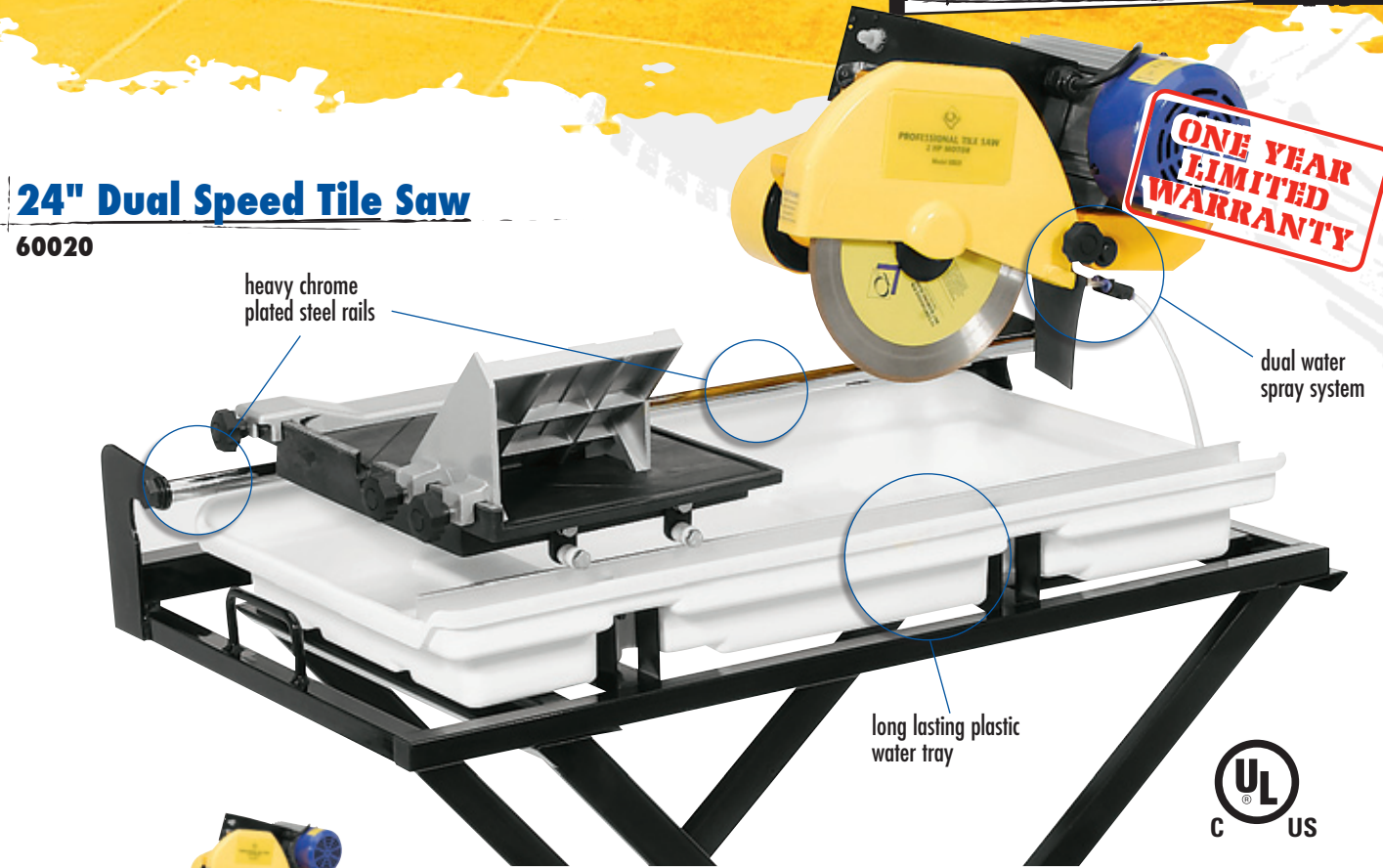

Folding stand

- Dual-speed 2 HP, 1750/2450 RPM motor cuts the toughest marble, granite, stone, porcelain & masonry products, as well as all types of tile\*
- Motor is mounted on a rugged steel support arm and mounting block for durability
- Enclosed dual water spray system evenly distributes water flow, extending the life of the diamond blade
- Rips up to a 24" tile and can diagonally cut a 14" tile
- Cutting table utilizes a slide-tube mounting system for smooth, accurate cutting
- Angle/rip guide and miter block make production cuts fast and consistent
- Automatic thermal overload protection prevents tile saw from overheating and damaging the internal parts of the motor
- Locking tilt-up blade guard makes blade changes quick and easy
- Rust proof, fiberglass impregnated water tray easily snaps in and out for easy cleaning
- Child-proof locking on/off switch with key provides additional safety
- One year limited warranty

\* for porcelain and hard tiles, we recommend QEP's Black Widow (#6-1008BW)



RIP



DIAGONAL

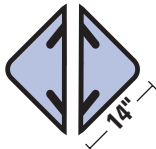

RIP AT  
10" WIDE



DEPTH



### ACCESSORIES INCLUDED

- Folding stand
- 10" continuous rim wet diamond blade (#6-1003CR)
- High volume water pump (#60095)
- 45° miter block
- 45° - 90° Angle/rip guide
- Wrenches and two hex keys

### SPECIFICATIONS

Item No:	60020
Motor:	2 HP / 120 V - 60 Hz / 15 Amps
Watts:	1500
RPM:	1750 / 2450 (dual speed)
Blade Capacity:	10"
Arbor:	5/8"
Rip Cut:	20" Tile (center) or 24" Tile (10" wide)
Diagonal Cut:	14" Tile
Depth of Cut:	3-1/4"
Size:	40" L x 22" W x 47" H (w/stand)
Weight:	116 lbs. (w/stand)

# Tile Saws

**Brutus**

## 24" Professional Tile Saw

61024

**QEP  
Exclusive  
Worldwide**

**ONE YEAR  
LIMITED  
WARRANTY**



adjustable tilting head

- Powerful 3450 RPM motor cuts the toughest marble, granite, stone, porcelain & masonry products, as well as all types of tile\*
- Enclosed dual water spray system evenly distributes water flow, extending the life of the diamond blade
- Rips up to a 24" tile and can diagonally cut a 18" tile
- Action cutting table for accurate cuts
- Adjustable tilting head offers quick and easy 45° to 90° miter cuts
- Automatic thermal overload protection prevents tile saw from overheating
- Locking tilt-up blade guard makes blade changes quick and easy
- Convenient stand with rear locking wheels keeps tile saw secure, and easily transportable
- Rust proof, fiberglass impregnated water tray
- easily slides in and out for easy cleaning
- Large non-slip rubber matted table with pull-out extension to support large format tile and slabs
- Angle/rip guide makes production cuts fast and consistent
- Rear water tray for water containment
- Plunge cutting for interior cut out of tile
- One year limited warranty

\* for porcelain and hard tiles, we recommend QEP's Black Widow Blade (#6-1008BW)



### ACCESSORIES INCLUDED

- Easy fold-out stand with 3" wheels
- 10" continuous rim wet diamond blade (6-1003CR)
- High volume water pump (#60095)
- Side table pull-out extension
- 45° - 90° angle/rip guide
- Rear water tray
- 2 wrenches

### SPECIFICATIONS

Item No:	61024
Motor:	120 V - 60 Hz / 9.5 Amps
Watts:	1100
RPM:	3450
Blade Capacity:	10"
Arbor:	5/8"
Rip Cut:	24" Tile
Diagonal Cut:	18" Tile
Depth of Cut:	2-3/8"
Size:	40" L x 21.5" W x 48.3" H (w/stand)
Weight:	105.8 lbs. (w/stand)

Please see page 10 – 11 for Tile Saw Replacement Blades

1.866.435.8665



## 7" Professional Tile Saw

60083



- Direct-drive, 1HP motor is surprisingly quiet but delivers enough power to handle ceramic, slate, marble, granite and porcelain\*
- Laser cutting guide projects accurate cutting path
- Water catch system reduces water run off and recycles water back into the reservoir minimizing fill frequencies
- Large die-cast aluminum cutting table for support of large tiles
- Tilt-up cutting table for precision 15°, 30° and 45° miter cuts
- Adjustable rip and sliding angle guides for accurate production cuts
- Child-proof locking on/off switch with key provides additional safety
- Automatic thermal overload protection prevents tile saw from overheating

### ACCESSORIES INCLUDED

- Laser cutting guide
- Locking rip guide
- Angle cutting guide
- Universal wrench
- 7" continuous rim wet diamond blade (6-7003CR)

\* for porcelain and hard tiles, we recommend QEP's Black Widow Blade (#6-7008BW)

### SPECIFICATIONS

Item No:	60083
Motor:	1 HP / 120 V - 60 Hz. / 6.25 Amps
Watts:	750
RPM:	3300
Blade Capacity:	7"
Arbor:	5/8"
Rip Cut:	Unlimited
Diagonal Cut:	Unlimited
Depth of Cut:	1-1/5"
Size:	22.2" L x 21.6" W x 11" H
Weight:	38.68 lbs.

## 7" Portable Tile Saw

60088



- Direct-drive 3/4 HP motor is surprisingly quiet and delivers enough power to handle ceramic, slate, marble, granite and porcelain\*
- Laser cutting guide projects accurate cutting path
- Water catch system reduces water run off and recycles water back into the reservoir minimizing fill frequencies
- Large steel cutting table for support of large tiles
- Tilt-up cutting table for precision 15°, 30° and 45° miter cuts
- Adjustable rip and sliding angle guides for accurate production cuts
- Automatic thermal overload protection prevents tile saw from overheating

### ACCESSORIES INCLUDED

- Laser cutting guide
- Locking rip guide
- Angle cutting guide
- Universal wrench
- 7" continuous rim wet diamond blade (6-7003CR)

\* for porcelain and hard tiles, we recommend QEP's Black Widow Blade (#6-7008BW)

### SPECIFICATIONS

Item No:	60088
Motor:	3/4 HP / 120 V - 60 Hz. / 5 Amps
Watts:	550
RPM:	3300
Blade Capacity:	7"
Arbor:	5/8"
Rip Cut:	Unlimited
Diagonal Cut:	Unlimited
Depth of Cut:	1-1/5"
Size:	20.2" L x 19.6" W x 9.2" H
Weight:	29 lbs.

## 7" Tile Wet Saw

22500



rip and angle guide

- Direct-drive 3/4 HP motor is surprisingly quiet and delivers enough power to handle ceramic, slate, marble, granite and porcelain\*
- Water catch system reduces water run off and recycles water back into the reservoir minimizing fill frequencies
- Tilt-up cutting table for precision 15°, 30° and 45° miter cuts
- Adjustable rip and sliding angle guides for accurate production cuts
- Automatic thermal overload protection prevents tile saw from overheating
- Convenient storage for rip guide and cable

### ACCESSORIES INCLUDED

- Locking rip guide
- Angle cutting guide
- Universal wrench
- 7" continuous rim wet diamond blade (6-7003CR)

\* for porcelain and hard tiles, we recommend QEP's Black Widow Blade (#6-7008BW)

### SPECIFICATIONS

Item No:	22500
Motor:	3/4 HP / 120 V - 60 Hz. / 4.8 Amps
Watts:	550
RPM:	3600
Blade Capacity:	7"
Arbor:	5/8"
Rip Cut:	Unlimited
Diagonal Cut:	Unlimited
Depth of Cut:	1-1/4"
Size:	15.8" L x 15.4" W x 6" H
Weight:	14 lbs.

## Master Cut™ 7" Portable Tile Saw

60089



- Direct-drive 3/5 HP motor for cutting ceramic, slate, marble, granite and porcelain\*
- Blade cooling water reservoir is removable for easy cleaning
- Large steel cutting table for support of large tiles
- Tilt-up cutting table for precision 15°, 30° and 45° miter cuts
- Adjustable rip guide for accurate production cuts
- Splash guard keeps dust, debris and water spray to a minimum
- Automatic thermal overload protection prevents tile saw from overheating and damaging the internal parts of the motor

\* for porcelain and hard tiles, we recommend QEP's Black Widow Blade (#6-7008BW)

### ACCESSORIES INCLUDED

- 7" continuous rim wet diamond blade (6-7003CR)
- Rip guide
- Angle guide
- Tilt-up table for easy miter cuts
- Two wrenches

### SPECIFICATIONS

Item No:	60089
Motor:	3/5 HP / 120 V - 60 Hz. / 3.8 Amps
Watts:	450
RPM:	3600
Blade Capacity:	7"
Arbor:	5/8"
Rip Cut:	Unlimited
Diagonal Cut:	Unlimited
Depth of Cut:	1-5/16"
Size:	15.1" L x 15.6" W x 9" H
Weight:	28.6 lbs.



## 4" Portable Tile Saw

60084A

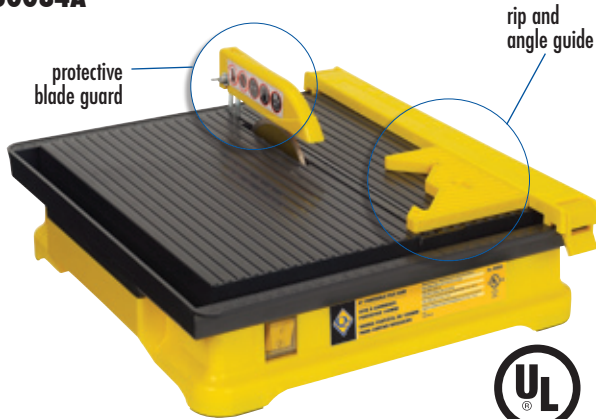

### ACCESSORIES INCLUDED

- 4" continuous rim wet diamond blade (#6-4003CR)
- 45° angle guide
- Rip guide
- Universal wrench

\* for porcelain and hard tiles, we recommend QEP's Black Widow Blade (#6-4008BW)

- Direct-drive 1/3 HP motor is surprisingly quiet and vibration-free for cutting ceramic, slate, marble, granite and porcelain\*
- Blade cooling water reservoir is removable for easy cleaning
- Large durable cutting table for support of large tiles
- Tilt-up cutting table for precision 15°, 30° and 45° miter cuts
- Adjustable angle and rip guides for accurate production cuts
- Splash guard keeps dust, debris and water spray to a minimum
- Automatic thermal overload protection prevents tile saw from overheating

### SPECIFICATIONS

Item No:	60084A
Motor:	1/3 HP / 120 V - 60 Hz / 1.5 Amps
Watts:	230
RPM:	3600
Blade Capacity:	4"
Arbor:	5/8"
Rip Cut:	Unlimited
Diagonal Cut:	Unlimited
Depth of Cut:	3/4"
Size:	14" L x 13" W x 4" H
Weight:	8 lbs.

## TILE SAWS AT A GLANCE

### Standing Saws

ITEM NO.	DESCRIPTION	SIZE (L x W x H)	WEIGHT (lbs.)	BLADE	ARBOR	AMPS	WATTS	RPM	rips / LENGTH (Tile Size)	DIAGONAL (Tile Size)	CUTTING DEPTH	WATER PUMP	ACCESSORIES INCLUDED
83240	40" Bridge Saw	55.5" x 37.2" x 48" (w/stand)	163	10"	5/8"	15	1800	3550	40"	28"	2"	60098	A, B, E, G, J, K, L, M
83230	30" Bridge Saw	46.3" x 19.8" x 57.5" (w/stand)	121.3	8"	5/8"	10.5	1362	3260	30"	22"	1-1/2"	60098	A, B, E, G, H, J, K, L, M, N
83200	24" Bridge Saw	37" x 18" x 47.5" (w/stand)	82.32	8"	5/8"	9.2	1100	3550	24"	18"	1-1/2"	60098	A, B, D, F, H, J, K, L, M
60020	24" Dual Speed Tile Saw	40" x 22" x 47" (w/stand)	116	10"	5/8"	15	1500	1750/2450	24"	14"	3-1/4"	60095	A, B, D, H, I, J, L
61024	24" Professional Tile Saw	40" x 21.5" x 48.3" (w/stand)	105.8	10"	5/8"	9	1100	3450	24"	18"	2-3/8"	60095	A, B, E, G, H, J, L, M, N

### Table Saws

ITEM NO.	DESCRIPTION	SIZE (L x W x H)	WEIGHT (lbs.)	BLADE	ARBOR	AMPS	WATTS	RPM	rips / LENGTH (Tile Size)	DIAGONAL (Tile Size)	CUTTING DEPTH	WATER PUMP	ACCESSORIES INCLUDED
60083	7" Professional Tile Saw	22.2" x 21.6" x 11"	38.68	7"	5/8"	6.25	750	3300	*	*	1-1/5"	-	B, H, I, J, K, L
60088	7" Portable Tile Saw	20.2" x 19.6" x 9.2"	29	7"	5/8"	6.25	550	3300	*	*	1-1/5"	-	B, H, I, J, K, L
22500	7" Tile Wet Saw	15.8" x 15.4" x 6"	14	7"	5/8"	4.8	550	3600	*	*	1-1/4"	-	B, H, I, L
60089	Master Cut™ 7" Portable Tile Saw	15.1" x 15.6" x 9"	28.6	7"	5/8"	3.8	450	3600	*	*	1-5/16"	-	B, H, I, L
60084A	4" Portable Tile Saw	14" x 13" x 4"	8	4"	5/8"	1.5	230	3600	*	*	3/4"	-	B, H, I, L

\*Unlimited

### ACCESSORY GUIDE:

- |                                     |                                    |                                     |                       |
|-------------------------------------|------------------------------------|-------------------------------------|-----------------------|
| A. Water Pump                       | E. Folding stand w/ locking wheels | I. 45° miter cutting guide / block  | M. Tilting head       |
| B. Continuous rim wet diamond blade | F. Rear wheel attachments          | J. Handle(s)                        | N. Plunge cut capable |
| C. Heavy duty stand w/ rear wheels  | G. Side extension table(s)         | K. Laser cutting guide              |                       |
| D. Heavy duty legs / fold-out stand | H. Angle/rip cutting guide         | L. Wrench, wrenches and/or hex keys |                       |

# Diamond Blades

The Q.E.P. diamond blade line offers a blade for every application and budget. Whether your tile project requires the cutting of ceramic, porcelain, marble, granite, glass, slate, concrete pavers or stone, Q.E.P. has a blade that will cut it quickly and efficiently. The high quality of Q.E.P.'s diamond blades is due to our stringent testing and exact specifications assuring the user a wobble-free blade that produces smooth and precise cuts.

## Continuous Rim



### Black Series

General purpose blade for wet or dry cutting of ceramic tile.

### Gold Series

Premium blade for wet or dry cutting of ceramic, porcelain and marble tile.

### Brutus Series

Long life ultra-premium, hi-rim blade for smooth, fast cutting of ceramic, porcelain, marble, granite, glass block, slate and stone tile.

Item No.	Description	Application	Rim Height	Width	Arbor Size	Max RPM	No in Case
6-4001CR	4" Continuous Rim - Wet/Dry	Ceramic tile	7mm	.060	7/8"-20mm-5/8"	15000	10
6-7001CR	7" Continuous Rim - Wet/Dry	Ceramic tile	7mm	.060	7/8"-5/8"-DM	8730	10
6-8001CR	8" Continuous Rim - Wet/Dry	Ceramic tile	7mm	.060	7/8"-5/8"-DM	7640	10
6-1001CR	10" Continuous Rim - Wet/Dry	Ceramic tile	7mm	.060	7/8"-5/8"-DM	6115	10
6-4003CR	4" Continuous Rim - Wet/Dry	Ceramic, Porcelain, Marble	7mm	.060	5/8"-20mm-7/8"	15000	8
6-7003CR	7" Continuous Rim - Wet	Ceramic, Porcelain, Marble	7mm	.060	5/8"	8730	8
6-8003CR	8" Continuous Rim - Wet	Ceramic, Porcelain, Marble	7mm	.060	5/8"	7640	8
6-1003CR	10" Continuous Rim - Wet	Ceramic, Porcelain, Marble	7mm	.060	5/8"	6115	8
6-4005CR	4" BRUTUS® Continuous Rim - Wet/Dry	Ceramic, Porcelain, Marble, Granite, Glass Block, Slate	8mm	.060	5/8"-20mm-7/8"	15000	10
6-7005CR	7" BRUTUS® Continuous Rim - Wet	Ceramic, Porcelain, Marble, Granite, Glass Block, Slate	10mm	.060	5/8"	8730	10
6-8005CR	8" BRUTUS® Continuous Rim - Wet	Ceramic, Porcelain, Marble, Granite, Glass Block, Slate	10mm	.060	5/8"	7640	10
6-1005CR	10" BRUTUS® Continuous Rim - Wet	Ceramic, Porcelain, Marble, Granite, Glass Block, Slate	10mm	.060	5/8"	6115	10

## Laser Welded, Segmented **Brutus®**



Premium long-life contractor-grade segmented blade for fast cutting of brick, concrete block and pavers.

Item No.	Description	Application	Rim Height	Width	Arbor Size	Max RPM	No in Case
6-4003SG	4" Segmented - Wet/Dry	Brick, Concrete Block, Pavers	7mm	.070	5/8"-20mm-7/8"	15000	10
6-7003SG	7" Segmented - Wet/Dry	Brick, Concrete Block, Pavers	7mm	.085	5/8"-7/8"-DM	8730	10

## Turbo **Brutus®**



Premium multi-purpose contractor-grade turbo blade for smooth cutting of brick, concrete block, pavers and stone

Item No.	Description	Application	Rim Height	Width	Arbor Size	Max RPM	No in Case
6-4003TB	4" BRUTUS® Turbo - Wet/Dry	Brick, Concrete Block, Pavers, Stone	7mm	.070	5/8"-20mm-7/8"	15000	10
6-7003TB	7" BRUTUS® Turbo - Wet/Dry	Brick, Concrete Block, Pavers, Stone	7mm	.085	5/8"-7/8"-DM	8730	10



# Diamond Blades



**The Blade that Bites Back**



The Black Widow Diamond blades are designed for quick cutting of hard tile including porcelain, ceramic, granite and marble, without wobble or chipping. Independent lab test results have proven that Black Widow specialty blades continuously out perform the competition in durability for a longer life and speed of cut, reducing project time.

- Premium-grade, thin-rim diamond blade for fast wet cutting of porcelain, ceramic, granite and marble tile
- Ideal for high speed cutting of hard masonry tile
- Unique diamond-shaped laser cutouts prevent blade wobble and keeps blade cooler for a longer life
- 7mm rim height for a longer life and for increased cutting contact with the blade

Item No.	Description	Application	Rim Height	Blade Width	Size	Max RPM	No in Case
6-4008BW	4" BLACK WIDOW™	Ceramic, Porcelain, Marble, Granite - Wet/Dry	7mm	.060	5/8"-20mm-7/8"	15000	5
6-7008BW	7" BLACK WIDOW™	Ceramic, Porcelain, Marble, Granite - Wet	7mm	.060	5/8"	8730	5
6-8008BW	8" BLACK WIDOW™	Ceramic, Porcelain, Marble, Granite - Wet	7mm	.060	5/8"	7640	5
6-1008BW	10" BLACK WIDOW™	Ceramic, Porcelain, Marble, Granite - Wet	7mm	.060	5/8"	6115	5

## 7" Glass Tile Cutting Diamond Blade

6-7006GL



- Premium blade for the wet cutting of glass tile
- Rim height 7mm
- Blade width .06"
- Maximum RPM of 8730
- 5/8" arbor

6-7006GL 7" Glass Tile Cutting Diamond Blade (3/case)

## 7" Masonry Blade

10029-15



- Cuts masonry, concrete block and brick/pavers
- Made of durable silicone carbide
- Fits most circular saws with diamond or 5/8" arbor

10029-15 7" Masonry Blade (15/case)

## Profile Wheels

6-6012PW  
6-8038PW



- Ideal for shaping the edges of tile, porcelain, marble, granite, limestone etc.
- 5/8" arbor

6-6012PW 6" Profile Wheel - 1/2" Radius (1/case)  
6-8038PW 8" Profile Wheel - 3/8" Radius (1/case)

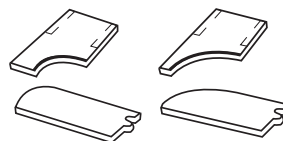

# Tile Saw Accessories

60098

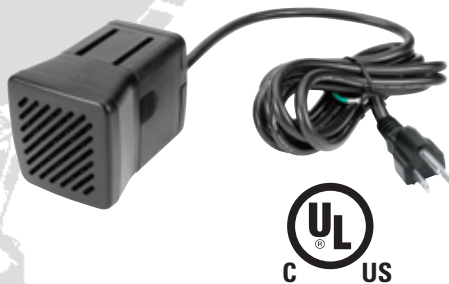

## Submersible Tile Saw Water Pump

**For 83200, 83240 and 83230 Tile Saws**

- Pumps 60 Gal (227.4L) per hour using 2' tubing (tubing not included)
- Corrosion resistant plastic housing for increased durability
- Removable easy-to-clean filter included

60098 Submersible Tile Saw Water Pump (1/case)

60095



## Submersible Tile Saw Water Pump

**For 60010, 60020, 60060 and 61024 Tile Saws**

- Pumps 54 Gal (203 L) per hour using 2' long tubing (tubing not included)
- Corrosion resistant plastic housing for increased durability
- Extra large intake reservoir with removable easy-to-clean filter

60095 Submersible Tile Saw Water Pump (1/case)

63025



## Tile Saw Laser Cutting Guide

- Attaches easily to most tile saw blade guards with 2 screws (included)
- Projects a bright laser line beam to aid in lining up saw blade with scribe mark on tile, adjustable for accuracy
- Battery powered (requires 2 AAA batteries, not included)

63025 Tile Saw Laser Cutting Guide (1/case)

63030



## Work Lamp

- Bright 20-watt halogen lamp illuminates critical work areas - flexible arm directs light focus
- Attaches to motor support of tile saw castings with two screws (drill bit and tap included)
- Plugs into switch box outlet, water pump plugs into lamp "stacking" plug

63030 Work Lamp (1/case)



**ROBERTS**

**10-55**



Includes:



- Carbide tipped saw blades provide long cutting life
- Anti-slag blade resists catching on hidden nails
- Durable masonry blade easily cuts through brick and cement block

- 10-47-2 6-3/16" 36-Tooth Carbide Tip Blade (2/case)  
 10-47-6 6-3/16" 20-Tooth Carbide Tip Blade (6/case)  
 10-55-24 Masonry Blade (24/case)  
 10-55 Long Neck 6" Jamb Saw (1/case)

## Long Neck 6" Jamb Saw

- Extended "tail" for maximum leverage against torque
- Powerful, 1050 watt industrial grade power unit
- Patented design enables saw to cut full inside corners in molding up to 1/2" thick
- Adjustable cutting depth guide prevents cutting into plaster or wall board when trimming base boards
- Easy access trigger for better control
- Precision height adjustment from "flush" to 1-1/16"
- Doors as thick as 1-3/4" can be undercut without removal
- Includes 6-3/16" 36-tooth carbide tip blade and masonry blade
- Custom molded carrying case

### SPECIFICATIONS

Item No:	10-55
Motor:	120 V - 60 Hz / 9.5 Amps
Watts:	1050
RPM:	8,000
Blade Capacity:	6-3/16"
Arbor:	5/8"
Depth Cut:	1-3/4"
Size:	18" L x 5.5" W x 8.5" H
Weight:	10 lbs.

**21643**



### ACCESSORIES INCLUDED

- Custom molded carrying case
- 4" continuous rim wet/dry diamond blade (#6-4001CR)
- Hardware for quick blade changes

- 21643 4" Professional Handheld Tile Saw (1/case)  
 21640 Water Adapter Kit\* (1/case)

\* Saw is not UL approved with water adapter kit attached

## 4" Professional Handheld Tile Saw

- Ideal for cutting tile, stone, granite, block, brick and marble
- High performance 1-1/2 HP motor
- Compact and lightweight
- Adjustable steel base to change cutting depth and angle
- Bevel cuts from 0° - 45°
- Comfort rubber grip and easy ON/OFF push button trigger
- Double insulated; ensures no water damage to motor

### SPECIFICATIONS

Item No:	21643
Motor:	1-1/2 HP / 120 V - 60 Hz / 10 Amps
Watts:	1150
RPM:	11,800
Blade Size:	4"
Arbor:	20mm
Depth of Cut:	1-1/4" at 90° 1-1/8" at 45°
Size:	11.25" L x 9.5" W x 8.25" H
Weight:	11 lbs.

21660



Variable speed trigger

## Power Mixer with Paddle

- Mix mortar, thinset, grout and other viscous materials with minimal effort, strong enough to mix cement
- High quality, powerful 1300 Watt motor
- High torque 2- speed motor- 1st gear: 180-460 RPM / 2nd gear: 300-700RPM
- Ergonomic handle grip to reduce fatigue and minimize strain
- Male-threaded 2-piece paddle specially designed to completely mix full bucket loads of viscous materials
- Motor housing is lightweight and impact resistant
- Variable speed trigger controls RPM's, which prevents splashing at start-up

21660  
21661

Power Mixer w/ Paddle (1/case)  
One-piece replacement paddle (1/case)

### SPECIFICATIONS

Item No:	21660
Motor:	110 V - 1300 Watts - 2-speed - 1st gear: 180 - 460 RPM, 2nd gear: 300 - 700 RPM
AMPS:	11
Weight:	13 lbs.

21650



21650

Heavy Duty "D" Handle Mixing Drill  
w/ blow mold case (1/case)

## Heavy Duty "D" Handle Mixing Drill

- 100% die cast aluminum housing protects the internal components from every day wear and tear
- 0-600 RPM variable speed switch reduces air bubbles when mixing thinset and grout
- High torque double reduction gears provide increased torque for mixing even the thickest mortars
- D-handle and side handles provide comfort and maximum mixing leverage
- Larger chuck (5/8") accommodates a wider range of bits, making the 21650 a more versatile mixer

### SPECIFICATIONS

Item No:	21650
Volts:	110 V 60 Hz
AMPS:	6
Motor:	650 Watts (0-600 RPM)
Weight:	12.81 lbs. / 5.8 kgs



## Threaded Mixing Paddle

21661

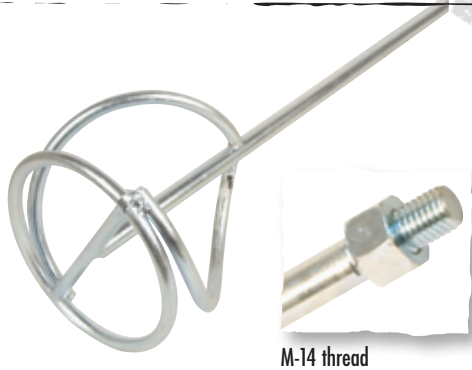

M-14 thread

- Replacement paddle for 21660 or any mixer that accepts M14 thread
- Specially designed paddle for fast and effective mixing of thick and dense materials
- M-14 thread design for paddle stability during mixing
- Shaft diameter 1/2", length 24", blade width 5-1/2"

21661 Threaded Mixing Paddle (1/case)

## Thinset and Grout Mixing Paddle

75001

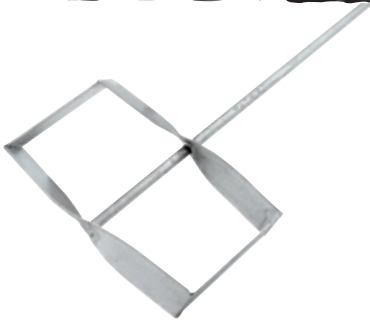

- Mixes grouts, thinsets and other setting materials with a minimum of air
- Fits standard 1/2" or 3/8" drill chuck
- Shaft diameter 3/8", length 19-1/2", blade width 8-3/8"

75001 Thinset and Grout Mixing Paddle (6/case)

## Mixing Paddle

61205

**Brutus**

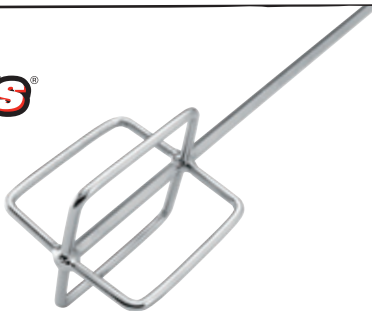

- Preferred by professionals for fast and easy mixing of grouts, thinsets and other setting materials
- Fits standard 1/2" or 3/8" drill chuck
- Shaft diameter 3/8", length 22", blade width 5"
- Chrome-plated for easy clean up

61205 Mixing Paddle (6/case)

## Universal Mixing Paddle

61210

**Brutus**

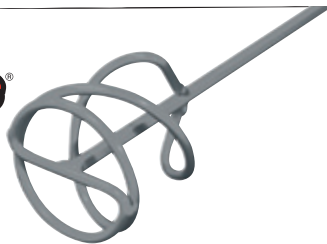

- The special design of the blades takes the stress and high torque off the drill, excellent for cordless drills
- The optimal mixing tool for small volumes of thinsets, mortars, cement, plaster and similar viscous materials
- Fits standard 1/2" or 3/8" drill chuck
- Shaft diameter 3/8", length 16", blade width 3-1/4"

61210 Universal Mixing Paddle (12/case)

## Plastic Mixing Buckets

78200, 78208



- Strong but inexpensive white opaque plastic buckets with handles

78200 5 Gallon Plastic Mixing Bucket - White (6/case)  
78208 3-1/2 Gallon Plastic Mixing Bucket - White (1/case)  
78217 15 Litre Plastic Mixing Bucket - White (1/case) (Canada Only)  
78300 10 Litre Plastic Mixing Bucket - White (1/case) (Canada Only)  
78201 Pour Spout Lid for 78200, 78217 & 78300 (1/case) (Canada Only)

# Hole Saws & Drill Bits

10566, 10568

**Brutus**



## Porcelain Diamond Drill Bit with Water Delivery System

- Ideal for cutting 5/16" holes when installing towel bars, soap dishes, shelves, cabinets and shower door frames
- Diamond Grit edge drills through ceramic, glass, marble, porcelain and granite
- Drill guide and water delivery system included (use wet-only)
- Fits standard 1/2" or 3/8" drill chucks

10566 5/16" Porcelain Diamond Drill Bit w/Drill Guide and Water Cooling System (6/case)

10568 1/4" Porcelain Diamond Drill Bit w/Drill Guide and Water Cooling System (6/case)

10567 Diamond Drill Bit Mounting Tape (12 pc/bag)

## Porcelain Diamond Hole Saw with Water Delivery System

10569

**Brutus**



- For cutting 1-3/8" diameter holes in glass, ceramic, marble and granite
- Special diamond grit edge for faster smoother cuts
- Ideal for faucet, pipe and showerhead installations
- Can be used on any type of hand drill, except hammer drills
- Included drill guide and water cooling cup easily supplies water to drill bit (use wet-only)
- Fits standard 1/2" or 3/8" drill chucks

10569 1-3/8 Porcelain Diamond Hole Saw w/Drill Guide and Water Cooling System (6/case)

10570 1-3/8 Hole Saw Mounting Tape (12 pc/bag)





# Tile Cutters

## Big Clinker Tile Cutters

10800, 10500

Large, high-leverage bicycle grip handle makes cutting easier and reduces fatigue

AVAILABLE IN 2 SIZES: 20" & 27"

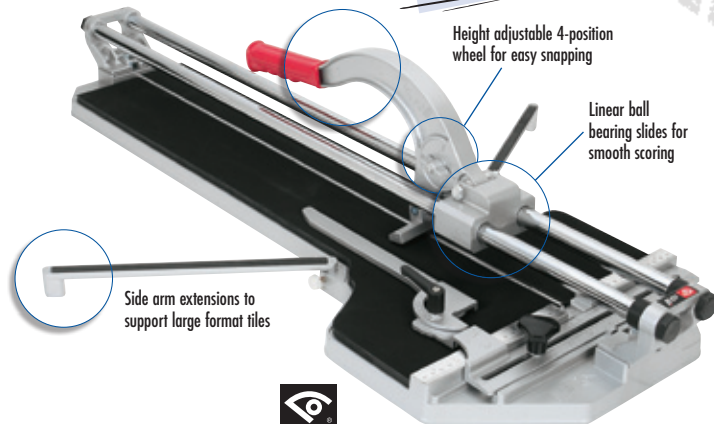

- Multi-purpose cutter for most tile including ceramic and porcelain
- Dual chrome plated rail bars
- Height adjustable 4-position wheel for easy snapping in any position on tile
- Wide die cast aluminum alloy base with heavy duty rubber pads for cutting stability
- Adjustable U.S. standard and metric measuring guide provides accurate repeat cuts
- Linear ball bearing slides for smooth scoring
- Large, high-leverage bicycle grip handle makes cutting easier and reduces fatigue
- Equipped with replaceable 7/8" titanium-coated tungsten carbide ball bearing cutting wheel
- Side arm extensions to support large format tiles

- 10800 27" Big Clinker Tile Cutter - Cuts tile up to 27", 20" diagonally, 1/2" thick (1/case)
- 10500 20" Big Clinker Tile Cutter - Cuts tile up to 20", 16" diagonally, 1/2" thick (1/case)
- 21123 7/8" Titanium-Coated Tungsten Carbide Cutting Wheel (6/case)

## Big Clinker Tile Cutters

10600

Large, high-leverage bicycle grip handle makes cutting easier and reduces fatigue

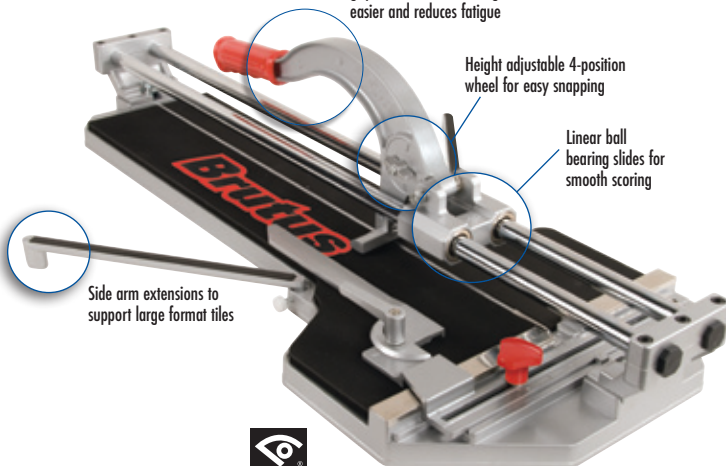

**Brutus**

- Multi-purpose cutter for most tile including ceramic and porcelain
- Dual chrome plated rail bars
- Height adjustable 4-position wheel for easy snapping in any position on tile
- Wide die cast aluminum alloy base with heavy duty rubber pads for cutting stability
- Adjustable U.S. standard and metric measuring guide provides accurate repeat cuts
- Linear ball bearing slides for smooth scoring
- Large, high-leverage bicycle grip handle makes cutting easier and reduces fatigue
- Equipped with replaceable 7/8" titanium-coated tungsten carbide ball bearing cutting wheel
- Side arm extensions to support large format tiles

- 10600 24" Big Clinker Tile Cutter - Cuts tile up to 24", 18" diagonally, 1/2" thick (1/case)
- 21123 7/8" Titanium-Coated Tungsten Carbide Cutting Wheel (6/case)

10552

BONUS EXTRA CUTTING WHEEL INCLUDED

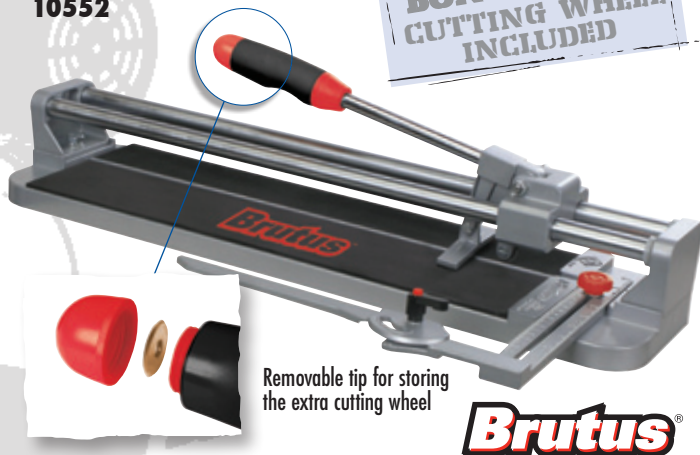

**Brutus**

## 20" Tile Cutter

- Cuts wall and floor tile up to 20", 14" diagonally, 1/2" thick
- Linear ball bearing slides for smooth scoring
- Dual chrome-plated steel rails ensure easy movement
- Die cast aluminum alloy base is lightweight but durable
- Adjustable rip guide with U.S. standard and metric measurements makes multiple rip and diagonal cuts easier and faster
- Thick heavy duty rubber pads prevent tiles from shifting
- Equipped with two replaceable 7/8" titanium-coated tungsten carbide cutting wheels
- Unique comfort grip handle with removable tip for storage of extra cutting wheels

- 10552 20" Tile Cutter (1/case)
- 10117 7/8" Titanium-Coated Tungsten Carbide Cutting Wheel (3/case)
- 10119 7/8" Tungsten Carbide Cutting Wheel (3/case)

# Tile Cutters

10220



## 20" Tile Cutter

- Cuts wall and floor tile up to 20", 14" diagonally, 1/2" thick
- Heavy duty rubber pads prevent tiles from shifting
- Dual chrome-plated steel rails with bumpers for comfortable scoring
- Rubber padded aluminum alloy breaker bar will not mar tile
- Extra long, high-leverage handle makes cutting easier and reduces fatigue
- Equipped with replaceable 7/8" titanium-coated tungsten carbide cutting wheel

10220 20" Tile Cutter (4/case)  
10117 7/8" Titanium-Coated Tungsten Carbide Cutting Wheel (3/case)  
10119 7/8" Tungsten Carbide Cutting Wheel (3/case)

10214

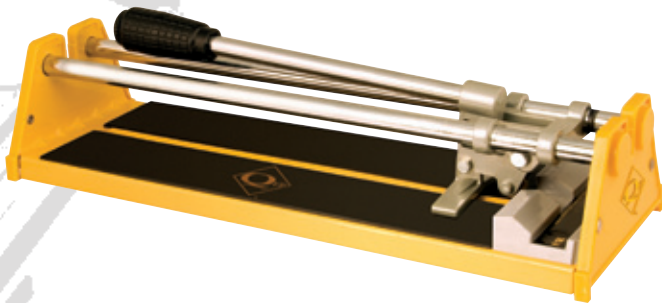

## 14" Tile Cutter

- Cuts wall and floor tile up to 14", 10" diagonally, 1/2" thick
- Linear ball bearing slides provide smooth scoring and repeat cuts
- Heavy duty rubber pads prevent tiles from shifting
- Dual chrome-plated steel rails with bumpers for comfortable scoring
- Rubber padded aluminum alloy breaker bar will not mar tile
- Extra long, high-leverage handle makes cutting easier and reduces fatigue
- Equipped with replaceable 7/8" titanium-coated tungsten carbide cutting wheel

10214 14" Tile Cutter (12/case)  
10117 7/8" Titanium-Coated Tungsten Carbide Cutting Wheel (3/case)  
10119 7/8" Tungsten Carbide Cutting Wheel (3/case)

14000



## 14" Tile Cutter

- Cuts wall and floor tile up to 14", 10" diagonally, 3/8" thick
- Rigid steel base with rubber pads maintains stable cutting
- Dual chrome-plated heavy duty, steel rails ensure smooth scoring
- Adjustable measuring guide provides accurate repeat cuts
- Solid aluminum yoke and breaker assembly easily snaps tile
- Equipped with replaceable 7/8" titanium-coated tungsten carbide cutting wheel

14000 14" Tile Cutter (4/case)  
10117 7/8" Titanium-Coated Tungsten Carbide Cutting Wheel (3/case)  
10119 7/8" Tungsten Carbide Cutting Wheel (3/case)



13000

Over 500,000 Sold!

**BONUS EXTRA CUTTING WHEEL INCLUDED**

**Brutus**



Removable tip for storing the extra cutting wheel

## 13" Tile Cutter

- Cuts wall and floor tile up to 13", 10" diagonally, 1/2" thick
- Dual chrome-plated steel rails ensure easy movement
- Padded die cast aluminum alloy base is lightweight but durable
- Adjustable rip guide with U.S. standard and metric measurements makes multiple rip and angle cuts easier and faster
- Equipped with two replaceable 7/8" titanium-coated tungsten carbide cutting wheels
- Unique comfort grip handle with removable tip for storage of extra cutting wheels

- 13000 13" Tile Cutter (6/case)  
 10117 7/8" Titanium-Coated Tungsten Carbide Cutting Wheel (3/case)  
 10119 7/8" Tungsten Carbide Cutting Wheel (3/case)

10267



## 12" Tile Cutter

- Cuts wall and floor tile up to 12", 8" diagonally
- Lightweight, compact and easy to use
- Reinforced steel base with rubber padded non-slip surface
- Equipped with long lasting 1/2" tungsten carbide cutting wheel

- 10267 12" Tile Cutter (6/case)  
 10268B 13" Tile Cutter (1/case)  
 10010HD 1/2" Tungsten Carbide Cutting Wheel for 10267 and 10268B (12/case)

### REPLACEMENT WHEELS FOR TILE CUTTERS

STK#	DESCRIPTION	10010HD	10117	10119	21123
10800	27" Big Clinker Tile Cutter				●
10500	20" Big Clinker Tile Cutter				●
10600	24" Big Clinker Tile Cutter				●
10552	20" Tile Cutter		●	●	
13000	13" Tile Cutter		●	●	
10267	12" Tile Cutter	●			
10220	20" QEP Tile Cutter		●	●	
10214	14" QEP Tile Cutter		●	●	
10268B	13" Tile Cutter	●			
14000	14" Tile Cutter		●	●	

# Nippers & Pliers

32015-6

**Brutus**



## Tile Nipper GT

- Premium quality 8" carbide-tipped tile nipper
- Rugged drop forged steel body, ground and polished 5/8" carbide tipped offset jaws for accurate cutting
- Center spring action improves feel and action
- For use with all types of tiles, including porcelain
- Cushion grip, comfortable contoured handles are curved for high leverage

32015-6 Tile Nipper GT (6/case)

32025

**Brutus**



## Chisel Head Nipper

- Durable premium tungsten carbide nipper tips
- Great for removing baseboard or tack strip
- Multipurpose tool is perfect for replacing broken tiles
- Unique pry bar for lifting and repositioning of tile

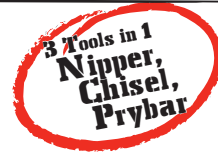

32025 Chisel Head Nipper (6/case)

10003



## Tile Nipper

- Professional parallel carbide "tipped" nippers stay sharp
- Drop forged 8" nippers made from select steels with offset jaws
- Comfortable contoured handles and cushioned grip

10003 Tile Nipper (12/case)

32010

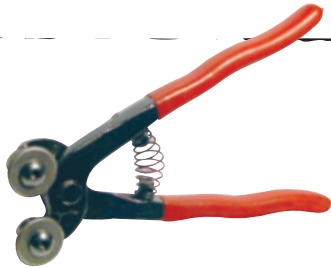

## Glass Tile Nipper

- Designed to easily cut glass without the use of conventional glass cutters
- Ideal for quickly cutting small mosaic pieces of glass and at removing tiny points from glass tile
- Cuts glass from 1/32" to 1/4" in thickness

32010 Glass Tile Nipper (6/case)

10094-6

**Brutus**

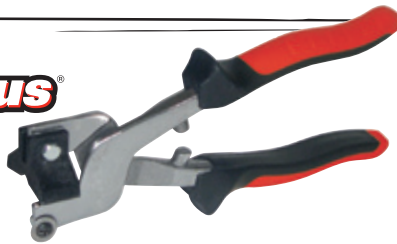

## Handheld Tile Cutter

- Uses a replaceable tungsten carbide wheel for scoring and a breaker bar to "snap" tile
- Durable drop-forged steel
- Cushioned grip, comfortable contoured handles
- Non-chip, nylon breaker brace

10094-6 Handheld Tile Cutter (6/case)

10010HD 1/2" Tungsten Carbide Cutting Wheels (12/case)

10004

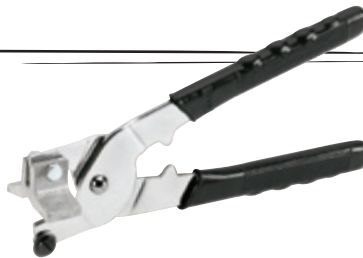

## Tile Pliers

- Replaceable tungsten carbide wheel for scoring
- Durable breaker bar to "snap" tile
- Heavy duty chrome-plated steel for long-lasting durability

10004 Tile Pliers (12/case)

10010HD 1/2" Tungsten Carbide Cutting Wheels (12/case)



# Marking & Cutting

10032

**Brutus®**



## 10" Contour Gauge

- Duplicates any shape for easy transfer to tile and other surfaces
- Durable plastic teeth - will not rust

10032 10" Contour Gauge (6/case)

38776



## China Markers - 2 pack

- Grease-type pencil for marking glazed materials
- One red and one black

38776 China Markers - 2 Pack (12/case)

10008-6



## Ceramic Rod Saw and Drill Bit

- Versatile kit cuts irregular shapes and circles from the center of tiles
- Kit includes a 6" tungsten carbide blade and carbide tipped drill bit

10008-6 6" Ceramic Rod Saw and Drill Bit (6/case)  
10030 6" Ceramic Rod Saw Replacement Blade (6/case)

10013, 10014, 10030

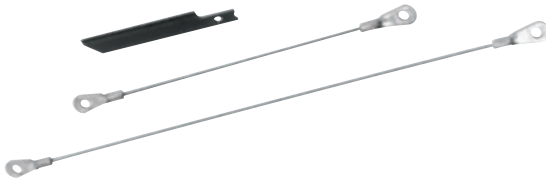

## Carbide-Coated Replacement Blades

10014 Saber Saw Blade (5/case)  
10030 6" Rod Saw Blade (6/case)  
10013 10" Rod Saw Blade (10/case)

10-303S, 10-321, 10-331, 10-323



## Chalk and Line Reel

- Special formula prevents caking and clotting

10-303S Chalk Reel  
10-321 White Chalk, 8 oz.  
10-331 White Chalk, 5 lbs.  
10-323 Blue Chalk, 8 oz.

10096

**Brutus**



## Undercut Saw

- 10-point aggressive tooth design for faster, cleaner cuts
- 12" Trapezoid shaped blade for easy access in small spaces
- High-carbon steel blade for added strength
- Ideal for undercutting door jambs
- Comfortable, contoured and cushioned grip handle

10096 Undercut Saw (6/case)

10091

**Brutus**



## Ceramic & Marble File

- Extra wide 1" x 7-3/4" carbide dual grit filing surfaces
- Fine grit for minor smoothing, course grit for smoothing harder surfaces
- Smooths and shapes marble, stone and ceramic tile edges
- Comfortable, cushioned grip handle
- Also good for use on saltillo tile

10091 Ceramic & Marble File (6/case)

10031



## Ceramic - Marble File

- Grit edge carbide file is ideal for sanding and smoothing out rough edges on ceramic tile and marble
- 5/8" x 5-1/2" flat and rounded surfaces for straight and contour shapes

10031 Ceramic-Marble File (6/case)

10022



## Dual Grit Rubbing Stone

- Dual grit surfaces smooth rough edges on freshly cut tile, stone, marble and brick
- 60-grit medium on one side and 80-grit fine on the other
- 6" x 2" x 1"

10022 Dual Grit Rubbing Stone (6/case)

10007-12

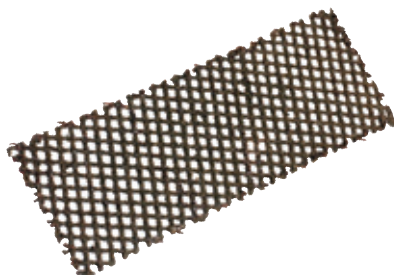

## Tile Sander

- Slightly flexible for shaping curves
- Finishes rough edges on ceramic and saltillo tile
- Can also be used on plaster and wood
- 7" x 2-1/2" x 0.05"

10007-12 Tile Sander (12/case)

62960

**Brutus**



Scraper head is reversible!

## Reversible Power Scraper

- Great for removing tile, wood, laminate, stone, carpet, ice and roofing
- Unique reversible hardened steel blade can easily be converted from 5" to 3" wide (ideal for scraping in tight areas)
- Re-sharpenable hard steel (use file or grinder)
- Galvanized steel ergonomic handle reduces fatigue
- Made in U.S.A.

62960 Reversible Power Scraper (3/case)

20900



Millions Sold!



## 14" Surface Scraper

- Flexible 14" blade helps remove old floors and clean up excess debris
- 5' long handle and flex blade made of premium quality carbon steel offer long-lasting durability
- Made in U.S.A.

20900 14" Surface Scraper with Blade (6/case)  
 21000 14" Replacement Blade (3/case)  
 60206 18" Surface Scraper with Blade (6/case)  
 60208 18" Replacement Blade (6/case)

75006K



## 7" Heavy-Duty Floor Scraper

- Thick, professional high-carbon steel 7" blade scrapes up concrete, marble, ceramic tile and wood floors
- All welded construction made of pipe steel with a replaceable rigid blade
- Rips up roofing, asphalt, tile and chips away cement and plaster
- 4' long handle includes foot peg for better leverage on difficult projects
- Great for ice removal
- Made in U.S.A.

75006K 7" Heavy-Duty Floor Scraper with Blade (6/case)  
 75007 7" Replacement Blade (3/case)

62909



## 8" Adjustable Razor Floor Scraper

- Twist lock adjustable telescoping handle adjusts from 3' to 6' in length
- Removes old tile, adhesive, vinyl, carpet and other floor covering materials
- Deluxe cushioned grip handle provides added comfort
- 15° angled 8" blade head for ease of comfort when scraping
- Canvas blade guard included

62909 8" Adjustable Razor Floor Stripper (6/case)  
 62904 8" Replacement Blade (3 on a skincard) (10/case)  
 62907 8" Replacement Blades (10 on a skincard) (1/case)

62900



## 4" Razor Scraper

- Scrapes residue off subfloors, windows and walls
- Great for wallpaper removal
- Complete with 4" blade

62900 4" Razor Scraper (12/case)  
 62901 4" Razor Scraper Replacement Blades (5 on a skincard) (6/case)  
 62801 4" Razor Scraper Replacement Blades (10 on a skincard) (1/case)





Carefully manufactured to meet the highest specifications, QEP's full line of trowels offer an assortment of handles, materials and notch sizes for both the professional and the weekend warrior. The trowels selected for this complete program include notches selected for a broad range of tile installation applications, including projects with tile sizes ranging from mosaics to large format tiles.

## Brutus®

### Stainless Steel Notched Trowels

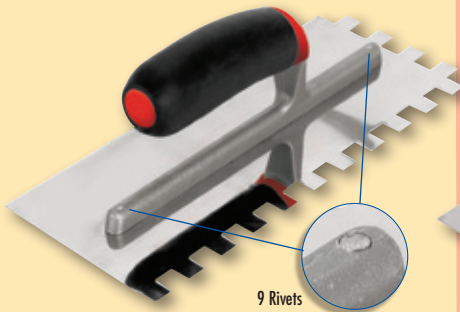

9 Rivets

- Rustproof stainless steel blade
- Large, contoured and cushioned grip handles for comfort
- High quality 11" x 4-1/2" trowel designed for the professional installer
- Durable 230mm zinc die-cast shank
- Extra handle-to-shank clearance to allow for complete hand rotation
- Longer shank with 9 rivets. First and last rivet reinforced and welded

No. in case 12

### Standard Notched Trowels



- Hardened and tempered steel blade, grounded and polished for long lasting durability
- Large wooden handle for an easy grip
- Quality trowel measuring 11" x 4-1/2" designed for the professional installer
- Aluminum die-cast shank
- Some notches available in 16" lengths

No. in case 12

### Economy Notched Trowels



- Hard, cold-rolled steel blade for longer wear
- High-impact black plastic handle
- Quality trowel measuring 9" x 4"

No. in case 30

See page 27 for the trowel notch number, size and application to meet your specific job.

**Always check adhesive/mortar manufacturers' trowel recommendations before selecting a trowel notch.**

See Roberts catalog for a complete listing of trowels for carpet, linoleum, VCT and wood flooring installations.

### Standard Finishing Trowels

49708, 49744



- High-carbon steel blade
- Large wood handles for easy handling

49708 11" Standard Finishing Trowel (4-1/2" x 11") (12/case)  
49744 16" Standard Finishing Trowel (4-1/2" x 16") (1/case)

## Brutus®

### Stainless Steel Finishing Trowel

49989

- Rustproof, stainless steel blade features longer shank with 9 rivets
- Extra handle-to-shank clearance allows for complete hand rotation
- Comfortable cushioned handle
- Size: 10-1/2" x 4-1/2"

49989 Stainless Steel Finishing Trowel (12/case)



**FOR TILE,  
MARBLE,  
STONE**

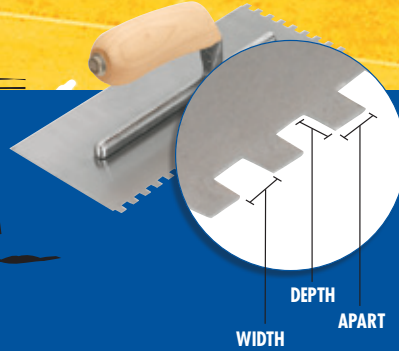

Always check adhesive/mortar manufacturer's trowel recommendations before selecting a trowel notch.

All Trowels Measure: Width x Depth x Space Apart

NOTCH#	SIZE	APPLICATION	<b>Brutus</b>	STANDARD	ECONOMY	16" PRO SERIES
<b>A4*</b>	 3/16" x 5/32" V	For plastic, wall, ceramic & metal tile 6" x 6" or smaller, mosaics on drywall & 3-ply & 5-ply engineered plank and wallbase	49917	49715	10115	-
<b>A6</b>	 1/4" x 3/16" V	For ceramic, metal & aluminum wall tile 6" x 6" up to 12" x 12"	49913	49716	10116	-
<b>A8*</b>	 1/4" x 1/4" x 1/4" SQ	For thinset application of ceramic tile 8" x 8" or smaller, laminated wood plank flooring, flat milled solid & shorts or plywood	49915	49713	10113	49725-1
<b>B3*</b>	 1/4" x 3/8" x 1/4" SQ	Thinset application of ceramic tile 8" x 8" up to 16" x 16"	49916	49714	10114	49726-1
<b>C9</b>	 1/2" x 1/2" x 1/2" SQ	Thinset or medium bed mortar application of natural stone, quarry tile, pavers, saltillo and ceramic tiles 12" x 12" and larger	49919	49720	10120	49727-1

\* Recommended notch sizes by NTCA (National Tile Contractors Association)

## Pointing Trowel

**92220**

- For patching cracks and shaping joints in brick, stone and concrete walls



92220 5-1/2" Pointing Trowel (12/case)

## Margin Trowels

**42103, 42105-12, 42106-12**

- For patch jobs, hard-to-reach areas and spreading thinset on v-cap or bullnose tile



42103 5" x 2" Margin Trowel No Notch (24/case)  
42105-12 5" x 2" V-Notch Margin Trowel 1/4" x 1/4" (12/case)  
42106-12 5" x 2" SQ-Notch Margin Trowel 1/4" x 1/4" (12/case)

## Wall Base Spreader

**10033** **ROBERTS**

- Durable cold-rolled steel blade for applying wall base adhesives
- Conveniently fits into a quart can



10033 Wall Base Spreader - V-Notch 3/16" x 5/32" (24/case)

# LASH™ Spacers

LASH™

99702, 99703, 99720, 99725

LEVEL • ALIGN • SPACE • HOLD

## LASH™

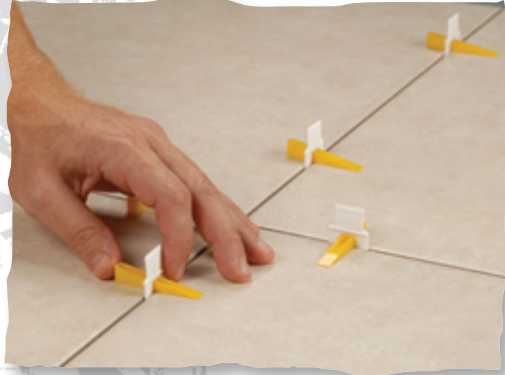

### Aligns & Holds Tiles for a Smooth Floor

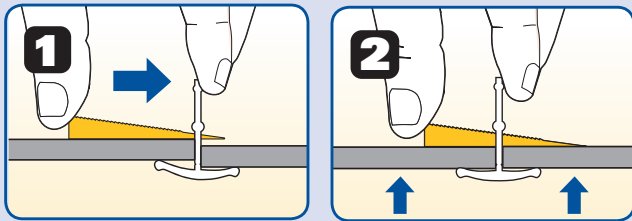

### For perfect tile-to-tile leveling

The patented LASH system is designed for quick installation and reduces costly call backs by insuring that the finished floor surface is lippage-free. This time saving system helps adjust the height of the tiles and evenly holds their edges throughout the curing process of the setting material.

- Durable nylon construction for a secure installation
- High-visibility yellow wedges are easy to distinguish on the job site
- Specially designed break-off point on clips for swift removal
- Produces 1/16" joint spacing
- May be combined with regular tile spacers for wider joints - up to 1/4"
- Wedges are reusable

### Advantages to the installer:

- Very easy to learn and use at any skill level
- Great for use with tiles of varied thickness
- Requires minimal effort to install and remove
- Virtually eliminates lippage
- Prevents tile from moving during the installation
- Speeds up installations
- Less time at the job = more jobs in one day = more profit
- Decreases call-backs due to poor installation

- |       |   |
|-------|---|
| 99702 | LASH Leveling Clips – 4800 pc. Contractor Pack  |
| 99703 | LASH Leveling Wedges – 3600 pc. Contractor Pack |
| 99720 | LASH Leveling Clips – 96/container (8/case)     |
| 99725 | LASH Leveling Wedges – 96/container (8/case)    |

### Easy to install and remove!

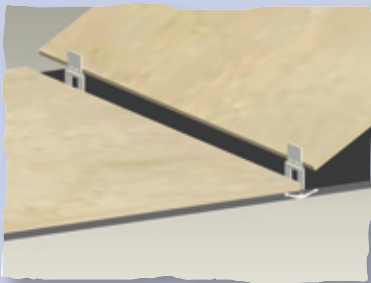

Step 1

Slide two **LASH** clips under the tile and into the mortar approximately 2" from each end of the tile. Place the second tile.

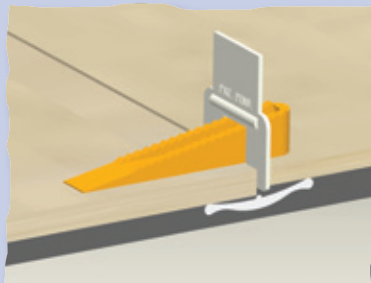

Step 2

Slide the reusable **LASH** wedges into the clips to **Level, Align, Space** and **Hold** the tiles.



Step 3

Once the mortar sets, simply kick the clips, forcing them to snap off at the specially designed break-points.



# Tile Spacers

10005, 10006, 10026,  
10027, 10316, 10281,  
10282, 10284, 10286

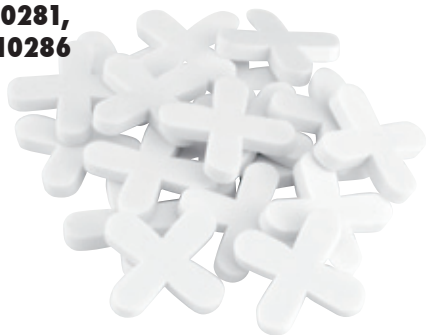

## Tile Spacers

- Precision cut for accuracy
- Evenly space tiles for uniform grout lines
- Provide quick, professional looking results
- Works with all sizes of ceramic tile, porcelain, stone and marble

10006	1/16" Tile Spacers – bagged	250 Qty.	(24/case)
10281	1/8" Tile Spacers – bagged	1000 Qty.	(12/case)
10026	1/8" Tile Spacers – bagged	250 Qty.	(24/case)
10316	3/16" Tile Spacers – bagged	200 Qty.	(24/case)
10284	3/16" Tile Spacers – bagged	500 Qty.	(12/case)
10005	1/4" Tile Spacers – bagged	200 Qty.	(24/case)
10282	1/4" Tile Spacers – bagged	400 Qty.	(12/case)
10027	3/8" Tile Spacers – bagged	100 Qty.	(24/case)
10286	1/2" Tile Spacers – bagged	50 Qty.	(24/case)

10067, 10068

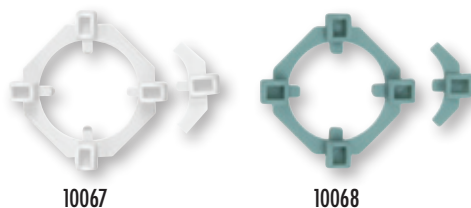

## Bulls•Eye Clearview Spacers

- Helps install tiles quickly and precisely
- One Bulls•Eye replaces four conventional style spacers
- Open center design allows the installer to instantly align tile corners

10067	1/16" and 3/16", 100 Spacers, 50 Spacer Wings (24/case)
10068	1/8" and 1/4", 100 Spacers, 50 Spacer Wings (8/case)

### Spacer wings fit perfectly on corner and angle applications!



Bulls•Eye ClearView Spacers™ are an economical and user-friendly solution for creating evenly spaced grout joints. The unique, patented design keeps the spacers out of the thinset and provides a clear view of grout lines and corners.

One Bulls•Eye Spacer does the job of four traditional spacers thus reducing the amount of total spacers needed for each job.

Each bag of Bulls•Eye Spacers comes with 100 spacer rings and 50 mini-wing spacers for use on corners along walls and angles. These spacers are easy to remove, reusable and perfect for floor and wall tile applications.

Bulls•Eye ClearView Spacers, unobstructed grout lines for dead-on accuracy.

### Two Spacers In One! Offers the option of two different grout joint widths

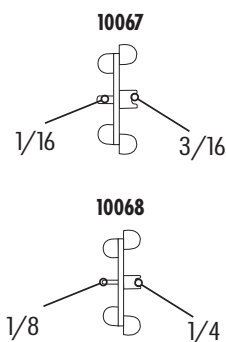

10285



## Wedge Tile Spacers

- Crucial for achieving a level first row of wall tile
- Ideal for maintaining level horizontal grout lines during installation
- Avoids tile slippage on vertical surfaces - will not compress

10285	Wedge Tile Spacers – 500/Pack (12/case)
-------	---

79632

**Brutus®**



## Quik-Cap Knee Pads

- 2 knee pads in one
- Hard cap easily glides over carpet
- Remove cap for mar-resistant, anti-slip protection on hard surfaces including tile, wood or vinyl
- Air-injected anti-compression gel foam core for maximum comfort

79632 Quik-Cap Knee Pads (6/case)

79630



## Comfort Grip Non-Slip Knee Pads

- Textured slip and mar resistant face — Perfect for hard floor surfaces including tile, wood and vinyl
- Comfort form-fitting foam padding
- Soft perspiration wicking fabric next to knee for maximum absorption
- Easy on and off adjustable no hassle plastic buckle
- Non-binding single strap will not pinch during extended wear

79630 Comfort Grip Non-Slip Knee Pads (12/case)

79638



## MAXFLEX Knee Pads

- All day comfort
- Non-scratch, non-skid outer shell
- Adjustable straps fit all sizes

79638 MAXFLEX Knee Pads (12/case)

79025



## Dual Comfort Knee Pads

- Non-liquid gel pads for all day comfort
- Convenient Velcro® strap attachment that will not pinch
- 100% washable neoprene that flexes with the body and resists sweat
- Protective, dual-stitch reinforced polyurethane coating
- Display box included

79025 Dual Comfort Knee Pads (6/case)

**79637**



## Contour Knee Pads

- Cradles knee for maximum comfort
- Washable
- Easy on/off Velcro® strap
- For hard or soft surfaces

**79637** Contour Knee Pads (12/case)

**79636**



## Gripper Gel Knee Pads

- Indoor / outdoor use
- Comfortable gel interior
- For hard or soft surfaces
- Lightweight and durable

**79636** Gripper Gel Knee Pads (18/case)

**79635**



## Foam Knee Pads

- Thick molded foam for comfort
- Lightweight and waterproof
- For hard or soft surfaces
- Velcro® strap for secure fit

**79635** Foam Knee Pads (18/case)

**21591**



## Heavy Duty Grouting Gloves

- Protects hands from the corrosive action of grout, chemicals and other harsh substances
- 100% heavy duty latex is puncture and tear resistant
- One size fits all
- Non-slip ribbing on thumb and finger surfaces

**21591** Heavy Duty Grouting Gloves (24/case)



## 70005 (series)

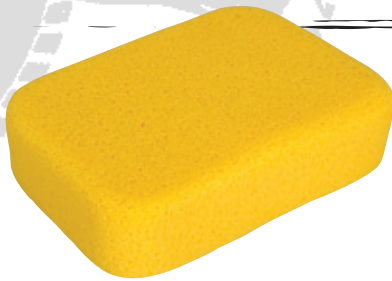

## SUPER Sponge

- Professional extra large premium sponge for grouting and clean up
- Unique hydrophilated design provides high water holding capacity
- Rounded edges minimize "digging out" or marring of grout
- 7-1/2" x 5-1/2" x 2"

70005-36	XL Grouting Sponges individually bagged (36/case)
70005-144	XL Grouting Sponges individually bagged in dump display (144/case)
70005-3D	XL Grouting Sponges Sponge Value 3 Pack in dump display (48/case)
70005-150	XL Grouting Sponges - Small Bale (150/bulk wrapped bale)
70005	XL Grouting Sponges - Bulk Bale (500/bulk wrapped bale)
70005-6D	XL Grouting Sponges Sponge Value 6 Pack in dump display (24/case)

## 70007 (series)

**Brutus**



## Scrubbing Sponge

- Professional hydrophilated grout sponge on one side and scrubbing sponge on the other creates dual usage
- Rounded edges minimize "digging out" or marring of grout
- 7-1/2" x 5-1/4" x 2"

70007-36	XL Scrubbing Sponges individually bagged (36/case)
70007-B	XL Scrubbing Sponges - Bulk Bale (500/bulk wrapped bale)

## 70011B (CANADA)



## Epoxy Sponge

- Perfect for cleaning and removing epoxy grout and grout haze
- Rounded edges minimize "digging out" or marring of grout
- 6" x 4-1/2" x 1-3/4"

70011B	Epoxy Sponge - Bulk Bale (300/bulk wrapped bale) (Canada Only)
--------	--

## 76030-12



## Cheese Cloth

- For removing grout haze after installation
- 5 square yards (36" x 180")
- Great for polishing most tile surfaces to a bright shiny finish
- 100% cotton, professional grade fine mesh

76030-12	Cheese Cloth (12/case)
----------	------------------------

## 70-125



## Carpet Groomer

- Raises trapped-in dirt and loosens embedded pet hair for easy removal
- Revitalizes carpet quickly without vacuuming
- Revives crushed and matted carpet
- Makes vacuum track marks disappear

70-125	Carpet Groomer (8/case)
--------	-------------------------

Extra wide (12") head to cover large areas quickly

## GUM RUBBER GROUT FLOATS

- Non-stick gum rubber ensures smooth application
- 2- rounded corners prevent gouging of grout joints
- 2- square corners ensure complete grout coverage in corners
- Extra thick aluminum backing plate for maximum leverage and applying grout into joints

### **Brutus** Premium Grout Float

10074-8



- Comfortable, contoured and cushioned grip handle reduces fatigue

10074-8 9-1/2" x 4" (8/case)

### Gum Rubber Grout Float

10061, 10063



- Premium gum rubber laminated to lightweight, closed cell core is built to last

10061 9-1/2" x 4" (12/case)  
10063 12" x 4" (6/case)

### Offset Grout Float

62422



- Ensures smooth application in those hard-to-reach areas

62422 12" x 3" (6/case)

### Molded Rubber Grout Float

10060



- Completely molded rubber pad prevents absorption of materials

10060 9-1/2" x 4" (12/case)

### Economy Rubber Grout Float

10062



- High-impact plastic handle with closed cell foam rubber pad for a smooth application

10062 9" x 4" (24/case)

### **Brutus** Epoxy Grout Float

10064-8



- Green pad with beveled sides resists epoxy grouts and other sticky materials

10064-8 9-1/2" x 4" (8/case)

### Red Rubber Float

62413



- Ideal for textured finishes on concrete or stucco
- Can also be used to apply grout

62413 9-1/2" x 4" (12/case)

### Margin Float

10073



- 6" x 2"
- Ideal for hard-to-reach areas such as kitchen backsplashes or under bath and kitchen counters

10073 6" x 2" (12/case)

### Grout Bag

76000



- Reinforced tip for smooth application and long life
- Protects hands from grout and other harsh substances
- Made of puncture and tear resistant coated vinyl

76000 Grout Bag (12/case)

# Kits & Miscellaneous

10002-6



## Tile Installation Kit

- 3-piece tile installation kit contains one each: V-notched and square-notched half-moon adhesive spreaders and one grout squeegee with wood handle
- 3/16" x 1/8" V-notched adhesive spreader is 6-1/4" in length
- 1/4" x 1/4" x 1/4" Square-notched adhesive spreader is 6-1/4"
- Squeegee is 7-1/8" long

10002-6 Tile Installation Kit (6/case)

78204HD



## Tile Tool Value Kit

- Complete kit containing all the tools necessary to install ceramic tile on floors
- Kit contains: Molded rubber float, 1/4" x 3/8" x 1/4" square notch floor trowel, 8" tile nippers, sponge, disposable gloves and reusable 2.5 gallon plastic bucket with complete installation instructions

78204HD Tile Tool Value Kit (1/case)

38223, 38222, 38224, 38221, 38220

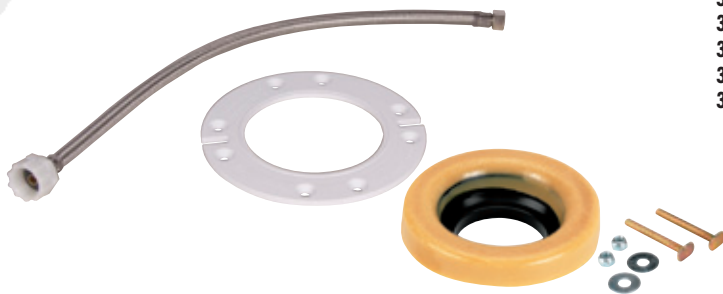

## Toilet Installation Accessories

- 38223 johni-ring® Large Wax Ring & Combo Kit (1/case)
- 38222 Fluidmaster® 16 in. SS Braided Toilet Connector (1/case)
- 38224 1/4 in. Flange Extension Ring (1/case)
- 38221 Toilet Bowl Wax Ring – bolts not included (6/case)
- 38220 Bolt Kit – 1/4" x 2-1/4" brass-plated closet bolts with nuts & washers (12/case)

10-519

**ROBERTS**

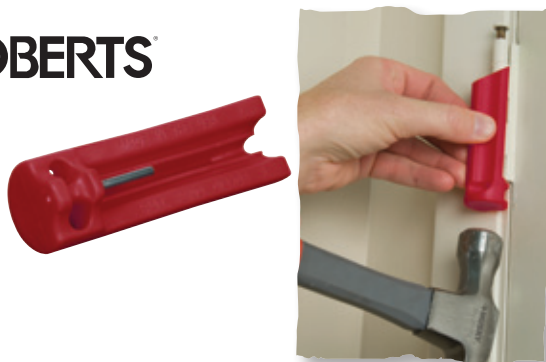

## Door Hinge Pin Remover

- High impact plastic protects doors and molding
- Nickel plated, hardened steel pin drives hinge pin out of hinge plate

10-519 Door Hinge Pin Remover (12/case)

1.866.435.8665



## Grout Saw

10090

**Brutus**



Flip down  
blade storage  
compartment

- For stripping, cleaning and removing old grout, thinset, calcium, rust and grime
- Equipped with: 1 straight carbide grit-edge and 1 steel tooth blade
- Use 2 blades for floor grout removal, 1 blade for walls
- Flip down blade storage compartment
- For grout joint 1/16" or wider

10090 Grout Saw (12/case)

10025-6 Replacement Blade Set (1 grit edge/1 steel) (6/case)

## Grout Saw

10012



- For stripping, cleaning and removing old grout
- Equipped with: 1 carbide grit-edge and 1 steel tooth blade
- Use 2 blades for floor grout removal, 1 blade for walls
- For grout joint 1/16" or wider

10012 Professional Carbide Grout Saw (12/case)

10025-6 Replacement Blade Set (1 grit edge/1 steel) (6/case)

## Grout Saw

10001



- For removing old grout
- Curved handle provides comfortable grip and prevents scraping of knuckles
- For grout joint 1/8" or wider

10001 Grout Saw (12/case)

## Grout Remover

10020

**Brutus**



- For removing unwanted grout, mortar, thinset, calcium, caulking and surface rust
- Durable carbide tips are reversible, providing six scraping edges for longer tool life
- Comfortable, contoured and cushioned grip handle
- For grout joints of any size

10020 Grout Remover (12/case)

## Silver Tip Flagged Counter Cleaning Brush

60311



- 14" solvent resistant polystyrene brush
- Split-tipped bristles brush away even the finest particles
- 6" x 2" x 1"

60311 Silver Tip Flagged Counter Cleaning Brush (12/case)

20836-24

scraper



## Grout & Tile Brush

- Thick, durable nylon bristles clean in corners and grout lines
- Curved handle design allows for cleaning in hard-to-reach places
- 7" long

20836-24 Grout and Tile Brush (24/case)

75000-6

**Brutus**



## Suction Cup

- For easy handling of non-porous tile, marble and glass during installation
- Holds up to 12 lbs.
- Suction cup pad is 4-1/2" in diameter
- 3-1/2" wide handle opening easily accommodates large hands

75000-6 Suction Cup (6/case)

61613

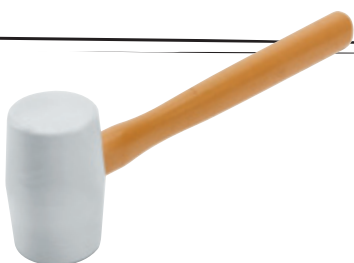

## White Rubber Mallet

- Will not mar tile or baseboard
- Non-marring rubber head securely mounted on hardwood handle
- The weight of mallet is 1.131 lbs., the rubber head itself is 1 lb.
- Mallet is 12-1/2" in length, the rubber head is 2" in diameter

61613 White Rubber Mallet (12/case)

19999-12



## Grout Sealer Bottle with Brush

- Great for small projects with narrow grout joints
- Works with all grout sealers

19999-12 4oz. (118ml) Grout Sealer Bottle w/ Brush (12/case)

10279



## Grout Sealer Bottle with Roller

- Wheel evenly applies sealer to grout joints
- Use 1/8" wheel for grout joints 1/8" and smaller
- Use 1/4" wheel for grout joints 1/4" and larger
- Works with all grout sealers

10279 12oz. (355ml) Grout Sealer Bottle w/ Roller (12/case)

10710



## Multi-Purpose Trim Shears

- Easily cuts tile trim, PVC piping, quarter round, tackstrip and other light materials
- Attached miter guide for precise cutting of angles
- Pre-notched guide at 45°, 60°, 75°, 90°, 105° and 120°

10710 Multi-Purpose Trim Shears (6/case)

50-540



## Double-Sided Acrylic Adhesive Strip for Vinyl

- For modified loose lay vinyl sheet flooring installation
- Odor free adhesive and no clean up required
- Great for flooring repairs

50-540 Double-Sided Acrylic Adhesive Strip for Vinyl  
- 1-7/8" x 50' (12/case)

## Double-Sided Acrylic Adhesive Strip for Carpet

50-550, 50-560, 50-565, 50-570



- For the installation of carpet, moldings and trim
- Works on indoor and outdoor installations
- Ideal for stairs and treads

50-550 Double-Sided Acrylic Adhesive Strip for Carpet - 1-7/8" x 75'  
Individually Boxed (12/case)

50-560 Double-Sided Acrylic Adhesive Strip for Carpet - 1" x 164'  
Individually Boxed (6/case)

50-565 Double-Sided Acrylic Adhesive Strip for Carpet - 3" x 164'  
Individually Boxed (3/case)

50-570 Double-Sided Acrylic Adhesive Strip for Carpet - 9" x 164'  
Individually Boxed (1/case)

## Traction Non-Slip Rug Strip

50-545



- Specifically designed non-slip strip for holding rugs and mats in place
- One side attaches permanently to the rug and the other side features a non-slip surface
- Easy to apply and requires no clean up

50-545 Traction Non-Slip Rug Strip - 2-1/2" x 25'  
Individually Boxed (12/case)

## Duct Tape

50-555



- Great for general repairs, projects, packing, seaming and sealing
- Easily tears by hand
- Conforms easily to uneven surfaces

50-555 Duct Tape - 1-7/8" x 60 yds, Individually Boxed (36/case)



# Laminate Installation

## Floor Boar® Laminate Cutter

10-452



No Messy Airborne Dust



Notch Cuts



Rip Cuts



- Cuts planks up to 12mm thick
- Innovative ratchet action handle continuously feeds planks into the cutting blades
- Works with all brands of laminate with or without attached padding
- Cuts planks to any length including cross cuts, notch cuts and angle cuts - no electricity needed
- Non-slip rubber feet for extra grip
- Dual 48-tooth hardened steel blades for long lasting use
- Solid steel reinforced base for stability

10-452 Floor Boar® Laminate Cutter (1/case)

10-452-A Replacement Blades (2 pack)

## 8" Laminate Cutter

10-35



- Cuts laminate up to 8" wide and 12mm thick
- Heavy duty steel frame for maximum stability
- Positionable "V" support keeps planks level while cutting

10-35 8" Laminate Cutter (1/case)

## Pro Pull Bar

10-18-8



- Used for floating floor and glue down installations of all brands of tongue and groove flooring
- 16-1/4" long; premium steel construction
- Angled profile allows planks to be tapped together in tight areas and at walls
- Soft felt backing protects floors from scratches during installation

10-18-8 Pro Pull Bar (8/case)

## Tapping Block

10-17-8

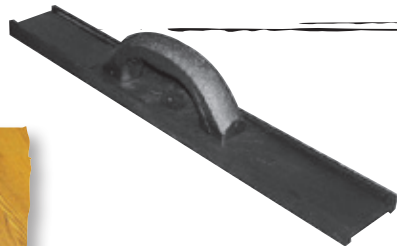

- Used to install all brands of tongue and groove flooring
- High density polypropylene base provides extended product life
- 20" profile equally distributes maximum tapping force
- Comfortable large grip handle
- 20" long

10-17-8 Tapping Block (8/case)

## Flooring Installation Kit

10-26, 10-27

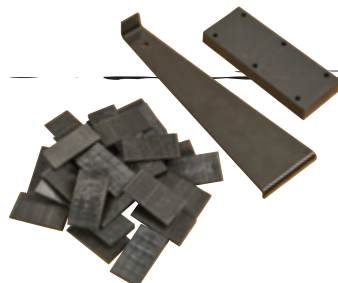

- Used to install all brands of tongue and groove flooring
- Use with glue down and floating floor applications
- Kit contains: 30 Spacers, Tapping Block, Pull Bar

10-26 Flooring Installation Kit (10/case)

10-27 Laminate Wedge Spacers Only (30 wedges/bag)

# Brick Installation

## Adjustable Brick Cutter

60510

**BLOCKBUSTER**



- Adjustable chisel head to easily perform angle cuts from 0° to 45°
- Protects hands when cutting
- Easy measurement guide for precise multiple cuts
- Durable 4" hardened steel cutting head

60510 Adjustable Brick Cutter (3/case)



Step 1

Set guide to desired length.



Step 2

Score all four sides.



Step 3

Firmly hit chisel head to shape.

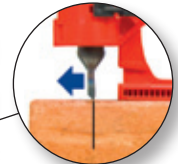

Front of blade faces waste side of brick.

## Magnetic Hammer

61605



- Magnetic head holds nails for rapid installation of floor and ceiling channel to concrete
- Quality 13" wooden handle
- Size: 13"L x 5-3/4"W

61605 20 oz. Magnetic Hammer (12/case)

61606 Magnetic Hammer-Head Only (1/case)

## Concrete Spreader with Brace

60201



- 20" wide spreader grades
- Hook provided for pulling up reinforced wire
- 60" hardwood handle with reinforced welded blade

60201 Concrete Spreader with Brace (6/case)

## Simulated Brick Cutter

60507



- Use to cut simulated brick face in mortar
- Adjustable height
- Hardwood handle with a 1/2" spring steel blade
- 5"L x 3/4"W x 3/4"H

60507 Simulated Brick Cutter (12/case)

# Cement Board Installation

10095-6

**Brutus**



Knuckle  
Guard

## Backerboard Scoring Knife

- For scoring cement backerboard, drywall and vinyl tiles
- Two carbide scoring tips provided, including one concealed in handle
- Protective knuckle guard

10095-6 Backerboard Scoring Knife (6/case)

10015



## Backerboard Scoring Knife

- Backerboard knife with 3 tungsten carbide tips for scoring cement backerboards
- Chisel tip included in handle for easy shaping

10015 Backerboard Scoring Knife (12/case)

99600

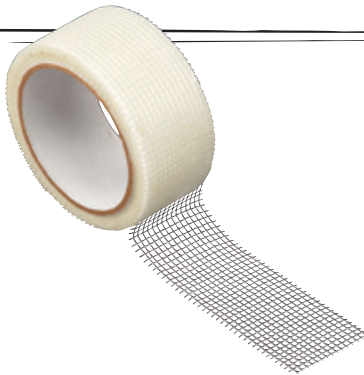

## Cement Board Seam Tape

- For use in seaming all types of cement backerboard and tile underlayment
- Alkali resistant fiberglass mesh, self-adhesive tape — reduces taping time
- Resists tears and will not shrink

99600 Cement Board Seam Tape — 2"x 50' roll (24/case)

99602



## Cement Board Screws

- For use in the attachment of Durock®, Wonderboard® and HardieBacker® cement board
- No pre-drilling necessary
- Corrosion resistant coating
- Wafer head with ribbed countersinking profile for flush seating

99602 1-1/4" - # 8 High Low Cement Board Screws, 200 screws/pkg (12/case)



# Underlayment

## Harmony® Premium 3-In-1

70-100-12, 70-100-1

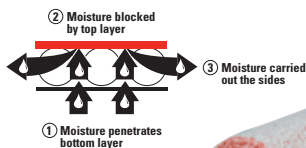

Creates a pocket of constantly circulating air which inhibits mold growth



- Sound resistant underlayment for use under all laminate and engineered hardwood floating floors
- Excellent moisture resistance
- Reduces ambient noise
- 8" overlap with adhesive strip for installation
- Outstanding compression resistance over time
- For use with below, on and above grade subfloors
- Ideal in condos and multi-level dwellings

70-100-1 *Harmony Premium 3-in-1* – 630 sq. ft. roll, 40" x 189' (1/case)

70-100-12 *Harmony Premium 3-in-1 in display carton* – 100 sq. ft. rolls, 40" x 30' (12/case)

IIC Rating*	STC Rating*	R-Value*
68	67	0.39

## Quiet Cushion

70-180



IIC Rating*	STC Rating*	Rating*
69	67	21

- Progressive Foam Technology (PFT) designed for supreme sound reduction
- Extra fine, cross linked foam for advanced moisture protection and shock absorption
- Δ Delta Rating of 21 - one of the best in the industry
- Excellent for radiant heat floors
- Mold and mildew resistant
- Anti-crush technology for excellent performance and long life
- Includes adhesive strip and 3" overlap film for linking multiple rolls
- 2 mm thick foam, cushions flooring
- For use under engineered and laminate flooring

70-180 *Quiet Cushion* – 100 sq. ft. roll, 43.5" x 27.5' (12/case)

## Soft Stride

70-185



IIC Rating*	STC Rating*
69	66

- Dense foam provides excellent sound reduction under engineered and laminate flooring
- Closed cell foam for excellent moisture protection
- Excellent for radiant heat floors
- Mold and mildew resistant
- Anti-crush technology for excellent performance and long life
- 2 mm thick foam, cushions flooring
- Includes adhesive strip and 3" overlap film for linking multiple rolls

70-185 *Soft Stride* – 100 sq. ft. roll, 43.5" x 27.5' (12/case)

## Super Felt

70-190

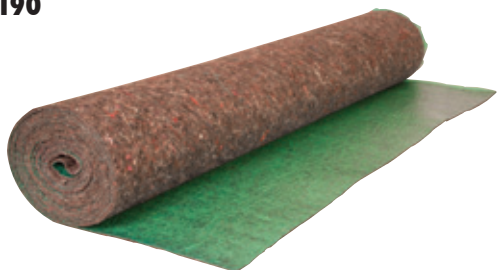

IIC Rating*	STC Rating*	Δ Rating*
67	66	21

- Provides deep, rich sound by absorbing noise instead of deflecting it
- Made from recycled fibers
- Extremely high temperature manufacturing process treats fibers
- 4mm thick pad corrects minor sub-floor imperfections
- Added R-Value to chilly floors
- Includes adhesive strip and 3" overlap film for linking multiple rolls
- For use under engineered and laminate flooring

70-190 *Super Felt* – 100 sq. ft. roll, 44" x 27.3' (1/case)

\* **IIC** measures sound such as moving furniture and walking, **STC** measures sound such as voices and television. Minimum sound rating required by most building codes and architects is 50. **R-Value** is the rating used to measure resistance to heat flow. **Δ Delta Rating** is the only true measurement of sound reduction from a product (not a floor assembly) in the industry.

# Underlayment

70-025



## Unison™ 2-in-1

- 3/32" polyethylene foam increases cushioning between flooring and subfloor
- 4" film overlap with adhesive strip for seamless protection
- Top film protects from harmful moisture vapor

70-025 Unison 2-in-1 – 100 sq. ft. roll, 48" x 25' (12/case)

70-010

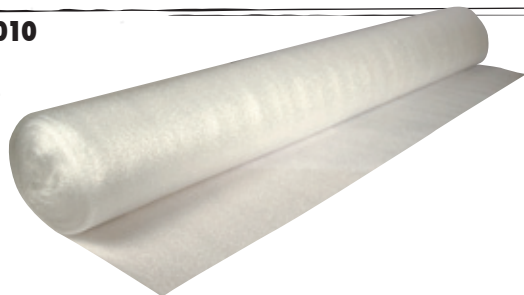

## Serenity Foam

- 3/32" polyethylene foam underlayment for laminate and engineered wood flooring
- Ideal for above grade uses
- Corrects minor subfloor imperfections

70-010 Serenity Foam – 100 sq. ft. roll, 48" x 25' (60/case)

72000



## Natural Cork Roll

- Reduces sound transmission from both the surface of a floor as well as through the floor to living spaces below
- Use under ceramic tile, stone, marble, engineered hardwood and laminate floors
- Acts as a crack isolation membrane that resists transfer of stress cracks from subfloor through to flooring surfaces
- Reduces thermal transmission, increasing the effectiveness of floor heating systems

72000 Natural Cork Roll – 200 sq. ft. roll, 48" x 50' x 1/4" (1/case)

Product	IIC Rating	STC Rating
72000 - with 6" cement slab	51	52
72000 - with 6" cement slab and suspended ceiling	61	60

72001, 72004,  
72025, 72006

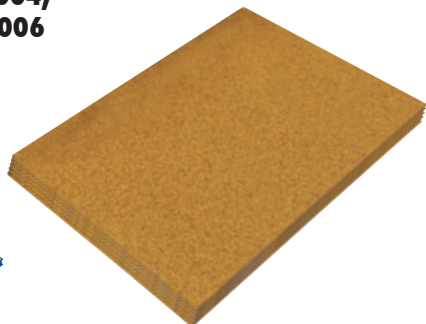

## Natural Cork Sheets

- Reduces sound transmission from both the surface of a floor as well as through the floor to living spaces below
- Use under ceramic tile, stone, marble, engineered hardwood and laminate floors
- Acts as a crack isolation membrane that resists transfer of stress cracks from subfloor through to flooring surfaces
- Reduces thermal transmission, increasing the effectiveness of floor heating systems

72001 1/2" (12mm) Natural Cork Sheets – 150 sq. ft./case, 2' x 3' (25/case)

*Canada Only*

72004 4mm Natural Cork Sheets – 456 sq. ft./case, 2' x 3' (76/case)

72025 2.5mm Natural Cork Sheets – 720 sq. ft./case, 2' x 3' (120/case)

72006 6mm Natural Cork Sheets – 312 sq. ft./case, 2' x 3' (52/case)

Product	IIC Rating	STC Rating
72001 - with 6" cement slab	74	75
72001 - with 6" cement slab and suspended ceiling	88	89
72004 - with 6" cement slab	49	-
72006 - with 6" cement slab	51	52
72006 - with 6" cement slab and suspended ceiling	61	60
72025 - with 6" cement slab and suspended ceiling	62	59

# Surface Protection

70-115



**ROBERTS**



## MoistureBarricade

- Use with standard foam underlayments to protect against moisture
- 6 mil. thick polyethylene film for long life
- Roll unfolds to cover an extra large 10' x 12' area
- Use with laminate flooring with pre-attached underlayment

70-115      *MoistureBarricade* – 120 sq. ft. roll, 10' x 12' (12/case)

70-120 (CANADA)



## Waxed Paper Roll

- High quality 30-lb. heavy duty Kraft paper for professional performance
- Use as a barrier between wood subfloor and new floor on above grade installations
- Helps in reducing squeaks in plywood subfloors
- Waxed on both sides for use with hardwood or engineered nail-down installations
- Use to slide boards into place with ease

70-120      *Waxed Paper Roll* – 750 sq. ft. roll, 36" x 250' (1/case) (Canada Only)

70-145



**Protect-It**  
Self Adhering Carpet Film

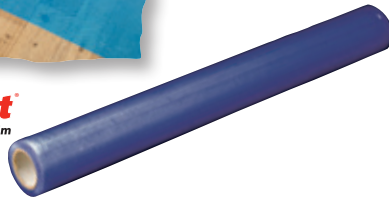

## Hard Surface Protective Film

- Ideal for hard floors including tile, wood and vinyl
- Protects from dirt and stains in high traffic areas
- Easy to roll on and remove
- 30 day temporary use

70-145      *Hard Surface Protective Film* – 100 sq. ft. roll, 24" x 50' (12/case)

70-130 / 70-140 / 70-150 / 70-160 / 70-170



70-140, 70-150,  
70-160, 70-170  
reverse wound  
for extra convenience

**Protect-It**  
Self Adhering Carpet Film



## Temporary Carpet Protection

- Protects - use as a temporary shield over carpeting (except wool)
- Consumer friendly - 50 foot rolls are great for shelf displays
- Individually boxed - informative box for easy sell-through

70-130      *Carpet Protective Film* – 100 sq. ft., 24" x 50' (20/display case)  
 70-140      *Carpet Protective Film* – 400 sq. ft., 24" x 200', Individually Boxed (6/case)  
 70-150      *Carpet Protective Film* – 750 sq. ft., 36" x 250', Individually Boxed (6/case)  
 70-160      *Carpet Protective Film* – 1500 sq. ft., 36" x 500', Individually Boxed (3/case)  
 70-170      *Carpet Protective Film* – 2000 sq. ft., 48" x 500', Individually Boxed (1/case)



# VITREX BRAND TOOLS... SIGN OF A PROFESSIONAL JOB

The perfect turn-key solution for small retailers! Takes out the guesswork by providing all the tools needed for a complete product offering. Full program fits perfectly on a standard 4' gondola rack.



## 20" Tile Cutter

**A09552**



- Cuts wall and floor tile up to 20" and 14" diagonally
- Equipped with a long-lasting 7/8" Tungsten Carbide cutting wheel
- Rip guide for easy production cuts
- Linear ball-bearing slides for smooth scoring
- Replacement wheels available (#A0 9117)

**A09552**      20" Tile Cutter (1/case)  
**A09117**      Tile Cutter Wheel - 7/8" (12/case)

## 16" Tile Cutter

**A09272**



- Cuts wall and floor tile up to 16" and 11" diagonally
- Equipped with a long-lasting 1/2" Tungsten Carbide cutting wheel
- Dual chrome-plated heavy duty steel rails ensure smooth scoring
- Replacement wheels available (#A0 9010)

**A09272**      16" Tile Cutter (4/case)  
**A09010**      Tile Cutter Wheel - 1/2" (12/case)

## 12" Tile Cutter

**A09267**



- Cuts wall and floor tile up to 12", 8" diagonally
- Lightweight, compact and easy to use
- The homeowner's choice for floor and wall projects
- Equipped with long lasting 1/2" tungsten carbide cutting wheel

**A09267**      12" Tile Cutter (6/case)  
**A09010**      Tile Cutter Wheel - 1/2" (12/case)

## Stainless Steel Notched Trowels

**A09626, A09627,  
A09628**

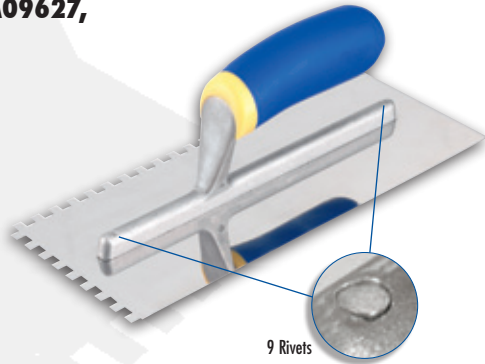

- Rustproof, stainless steel blade
- Large, contoured and cushioned grip handles for comfort
- High quality 11" x 4-1/2" trowel designed for the professional installer
- Durable 230mm zinc die-cast shank
- Extra handle-to-shank clearance to allow for complete hand rotation
- Longer shank with 9 rivets. First and last rivet reinforced

**A09626**    Stainless Steel Floor Trowel - 1/4" x 1/4" x 1/4" SQ (12/case)  
**A09627**    Stainless Steel Floor Trowel - 1/4" x 3/8" x 1/4" SQ (12/case)  
**A09628**    Stainless Steel Wall Trowel - 3/16" x 5/32" V (12/case)

## Molded Rubber Grout Float

**A09661**



- Dense solid rubber spreads grout evenly

**A09661**    Molded Rubber Grout Float (12/case)

## Economy Rubber Grout Float

**A09663**



- High-impact plastic handle with closed-cell foam rubber pad for a smooth application

**A09663**    Economy Rubber Grout Float (24/case)

## Combo Grout Spreader

**A02277**



- Notched edge for spreading adhesive
- Squeegee edge for grouting

**A02277**    Combo Grout Spreader (10/case)

**A09690**



## Heavy Duty Tile Nipper

- Premium quality 8" carbide tipped "GT" tile nipper
- Drop-forged steel, 5/8" offset jaws
- Center spring action improves feel and action
- Cushioned grip, comfortable contoured handles are curved for high leverage

**A09690 Heavy Duty Tile Nipper (12/case)**

**A09614**



## Tile Nipper

- Professional parallel carbide "tipped" nippers
- Drop-forged 8" nippers made from select steels with offset jaws
- Comfortable contoured handles

**A09614 Tile Nipper (12/case)**

**A09695**



## Handheld Tile Cutter

- Includes a carbide wheel for scoring and a breaker bar to "snap" tile
- Durable drop-forged steel
- Cushioned grip, comfortable contoured handles

**A09695 Handheld Tile Cutter (12/case)**

**A09620**



## Tile Scorer

- Tungsten carbide tip is built to last
- Comfort grip
- Suitable for scoring both wall and floor tile

**A09620 Tile Scorer (10/case)**

**A09706**



## Tile Hole Saw

- Efficient in cutting 1-3/8" holes in ceramic tile, cement board, dry wall, brick, fiberglass and wood
- Ideal for faucet and showerhead installations
- Features a unique bonded tungsten carbide "gulletted" cutting edge, resulting in much faster cuts, less dust, less chance of chipping and a longer life

**A09706 1-3/8" Tile Hole Saw (12/case)**



**A09033**

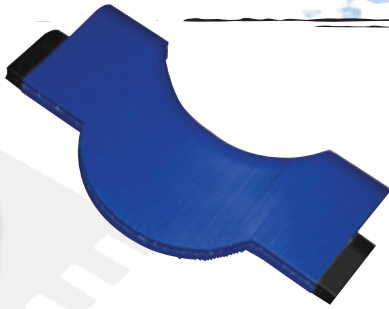

## 10" Contour Gauge

- Duplicates any shape for easy transfer to tile and other surfaces
- Durable plastic teeth - will not rust

**A09033** 10" Contour Gauge (6/case)

**A09790**



## Rod Saw and Drill Bit Kit

- Versatile kit drills and cuts ceramic tile at difficult angles
- Kit includes a 6" tungsten carbide blade and carbide-tipped drill bit
- Create hole with drill, insert saw blade for limitless applications

**A09790** 6" Rod Saw and Drill Bit Kit (12/case)

**A09712** 6" Rod Saw Replacement Blade (6/case)

**A09616, A09712, A09615**



## Carbide-Coated Replacement Blades

**A09616** Saber Saw Blade (5/case)

**A09712** 6" Rod Saw Blade (6/case)

**A09615** 10" Rod Saw Blade (10/case)

**A09796**



## Ceramic & Marble File

- Smooths and shapes tile edges
- 5-1/2" x 5/8" extra wide carbide grit filing surface
- Flat and rounded sides for straight and contour shapes
- Comfortable cushioned grip handle

**A09796** Ceramic & Marble Handheld File (6/case)

**A09714**



## Rubbing Stone

- Smooths rough edges on freshly cut tile
- 60 grit (medium) on one side, 80 grit (fine) on other side
- Also used for dressing dull diamond blades

**A09714** Rubbing Stone (2" x 5-7/8" x 1") (6/case)

**A02116**

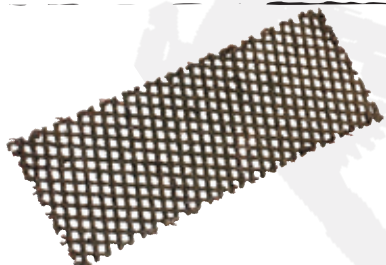

## Waffle Tile File

- Slightly flexible for smoothing inside curves
- Finishes rough edges on ceramic tile
- Perfect for use on saltillo tile

**A02116** Waffle Tile File (2-1/4" x 7") (12/case)

**A09590**



Knuckle  
Guard

## Backerboard Scoring Knife

- For scoring cement backerboard, drywall and vinyl tiles
- Two carbide scoring tips including one concealed in handle
- Protective knuckle guard

**A09590 Backerboard Scoring Knife (12/case)**

**A09798**



## Grout Removal Tool

- For removing unwanted grout, mortar or thinset
- Durable carbide tips are reversible, providing six scraping edges for longer tool life
- Comfortable, contoured and cushioned grip handle

**A09798 Grout Removal Tool (12/case)**

**A09694**



## Grout Saw

- For stripping, cleaning and removing old grout
- Equipped with: 1 straight carbide grit-edge and 1 steel tooth blade
- Use 2 blades for floor grout removal, 1 blade for walls
- Flip down blade storage compartment

**A09694 Grout Saw (12/case)**

**A09705 Grout Saw Replacement Blades (12/case)**

**A02420**



## Economy Grout Saw

- Use to remove old and discolored grout
- Tungsten carbide grit edge blade for longer life

**A02420 Economy Grout Saw (10/case)**

**A09802**



## Grout Brush

- Thick durable nylon bristles clean in corners and grout lines
- Curved handle design allows cleaning in hard-to-reach places
- 7" long

**A09802 Grout Brush (24/case)**

**A00204**



## Ceramic Floor Tile Installation Bucket

- Sturdy plastic bucket containing 6 items necessary to install ceramic tile on floors
- Kit contains: 8" Tile Nippers, 1/4" x 3/8" x 1/4" SQ-notched floor trowel, 1/4" floor tile spacers (200 pack), molded rubber float, sponge, disposable gloves and a sturdy, reusable 2.5 gallon plastic bucket with detailed instructions

**A00204 Ceramic Floor Tile Installation Bucket (1/case)**

**A02285**



## Tile Repair Kit

- Includes grout rake, Combo Spreader/Squeegee, grout finisher and sponge
- Complete for the easy removal and cleaning of discolored grout

**A02285 Tile Repair Kit (5/case)**

**102283**



## Flexi-Tip Sealant Smoother

- Unique, flexible tip for superb results on any surface
- Perfect for smoothing most household sealants, fillers, grout and putty
- Simple to use, easy to clean

**102283 Flexi-Tip Sealant Smoother (10/case)**

**A09807**



## Grout Sealer Applicator

- Quick and easy application of grout sealer
- Complete coverage of 1/8" and wider joints
- No mess, no dripping; neat application

**A09807 Grout Sealer Applicator (24/case)**



**A09640, A09644,  
A09650, A09656,  
102023, 102026,  
102042, 102052,  
102056**



## Tile Spacers

- Evenly spaces tile on walls and floors
- Precision cut for accurate floor installations

**A09640** 1/16" Tile Spacers Bag – 250 Qty. (24/case)  
**A09644** 1/8" Tile Spacers Bag – 250 Qty. (24/case)  
**A09650** 3/16" Tile Spacers Bag – 200 Qty. (24/case)  
**A09656** 1/4" Tile Spacers Bag – 200 Qty. (24/case)

**102023** 2.5mm Hard-style Tile Spacers Bag – 1000 Qty. (10/cs) (Canada Only)  
**102026** 2.5mm Hard-style Tile Spacers Tub – 3000 Qty. (1/cs) (Canada Only)  
**102042** 4mm Hard-style Tile Spacers Bag – 500 Qty. (5/cs) (Canada Only)  
**102052** 5mm Hard-style Tile Spacers Bag – 500 Qty. (5/cs) (Canada Only)  
**102056** 5mm Hard-style Tile Spacers Tub – 1500 Qty. (1/cs) (Canada Only)

**A09658**



## Spacer Remover

- Removes tile spacers from adhesive or thinset before grouting
- Comfort grip

**A09658** Spacer Remover (10/case)

**A00005**



## Super Sponge

- Professional extra large premium sponge for grouting and clean up
- Unique hydrophilated design provides high water holding capacity
- Rounded edges minimize "digging out" or marring of grout

**A00005** Super Sponge (36/case)

**A09750**



## Suction Cup

- For easy handling of non-porous tile, marble and glass during installation
- Holds up to 12 lbs.
- Suction cup pad is 4-1/2" in diameter
- 3-1/2" wide handle opening easily accommodates large hands

**A09750** Suction Cup (3/case)

**8850**

## 12 Gauge Hanger Wire - 100'

- Suspends main tees from eye lag screws in commercial applications

**8850**    12 Gauge Hanger Wire (12/case)**8851**

## 18 Gauge Hanger Wire - 300'

- Suspends main tees from eye lag screws in commercial applications

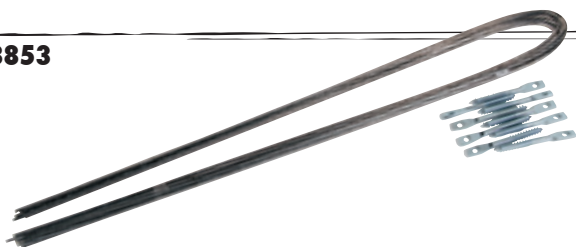
**8851**    18 Gauge Hanger Wire (12/case)**8853**

## Heavy Duty Hanger Wire Installation Kit

- Suspends main tees in commercial applications of approximately 256 sq. ft. with a maximum drop of 36"
- Contains:
  - 9 pieces of 45" long, 12 gauge hanger wire
  - 9 eye lag screws for wood joists

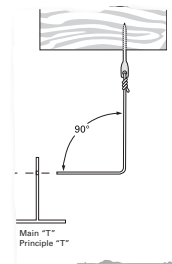
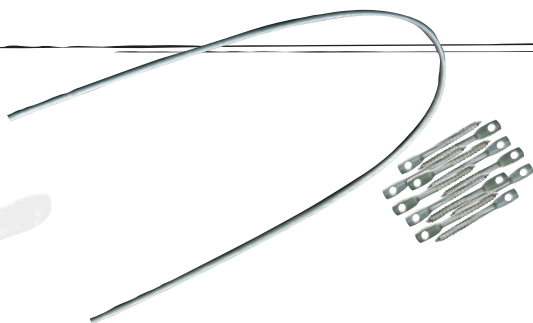
**8853**    **Heavy Duty Hanger Wire Installation Kit**  
(12/case)**8854**

## Light Duty Hanger Wire Installation Kit

- Suspends main tees in residential applications of approximately 192 sq. ft. with a maximum drop of 18"
- Contains:
  - 12 pieces of 30" long, 18 gauge hanger wire
  - 12 eye lag screws for wood joists

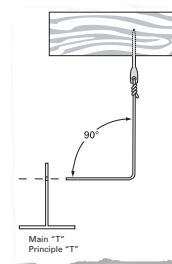
**8854**    **Light Duty Hanger Wire Installation Kit**  
(12/case)**8855**

## Wire-Fastening Nail Hooks

- Attaches ceiling hanger wire to wood

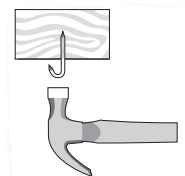
**8855**    **Wire-Fastening Nail Hooks - 20 pack**  
(12/case)

8856

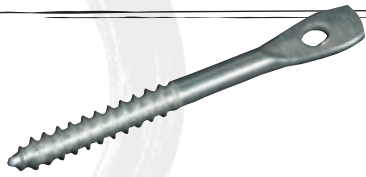

## Eye Lag Screws for Wood Joist

- Attaches ceiling hanger wire to wood joists
- 1/4" x 3" self-tapping sharp point

8856 12 Eye Lag Screws for Wood Joists - 100 pack (12/case)

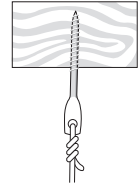

8857

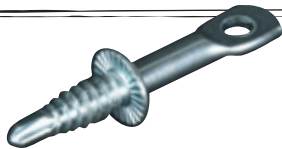

## Eye Lag Screws for Metal Joist

- Attaches ceiling hanger wire to metal joists
- 1/4" x 2" self-tapping drill point

8857 Eye Lag Screws for Metal Joist - 50 pack (12/case)

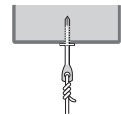

8858

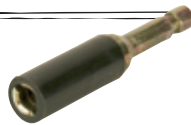

## Eye Lag Screw Drill Adapter

- Attaches to any 3/8" power drill
- For easy installation of eye lag screws

8858 Eye Lag Screw Drill Adapter (24/case)

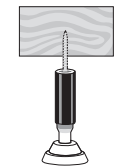

8859

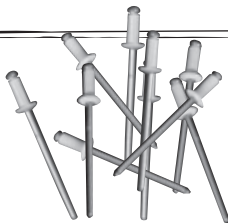

## White Rivets

- Rivets acoustical ceiling tile tees to perimeter wall angles at 4' intervals

8859 White Rivets - 100 pack (24/case)

8860

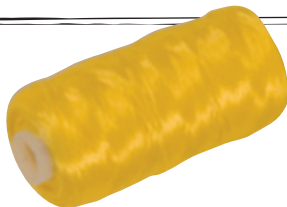

## Leveling Line - 450'

- Optic yellow color provides excellent visibility in any leveling job site
- Used in leveling and squaring suspended ceiling grid

8860 Leveling Line (12/case)



8861



## Grid Clamps

- Holds leveling lines during installation of main and cross tees
- Temporarily secures main and/or cross tees to wall angles when riveting

8861 Grid Clamps - 6 pack (12/case)





## Mounting Clips

8862



- For mounting electrical boxes, fire detectors, or other devices from main tees

8862 Mounting Clips - 4 pack (12/case)

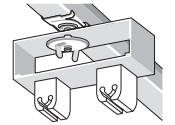

## Panel Clips

8863



- Holds ceiling tile panels secure against the grid in drafty areas

8863 Panel Clips - 20 pack (12/case)

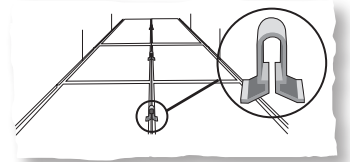

## Light-Duty Ceiling Hooks

8864



- Hangs lightweight objects such as plants, signs and decorations from ceiling tees

8864 Light-Duty Ceiling Hooks - 4 pack (24/case)

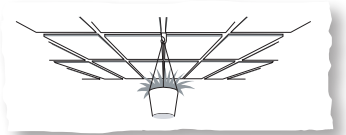

## Grid Installation Kit

8865



- Value pack contains tools and hardware to install ceiling grid in a 20' x 20' room (400 sq. ft.)
- Kit contains:
  - 18 gauge hanger wire - 64'
  - 2 grid clamps
  - 1 eye lag screw drill adapter
  - 50' leveling line
  - 20 white rivets
  - 16 eye lag screws for wood joists

8865 Grid Installation Kit (12/case)

## Grid Punch - 1/8"

8866

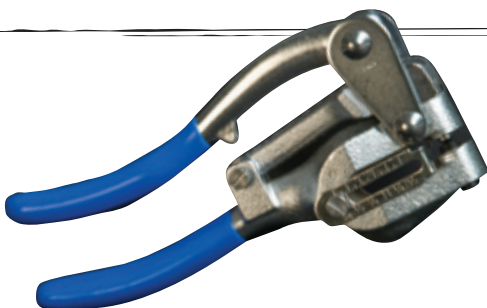

- For punching holes in main tees for hanger wire attachment
- For punching pilot holes in wall angle, main tees or cross tees that need to be secured with rivets

8866 Grid Punch - 1/8" (6/case)

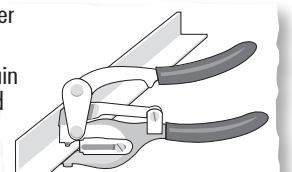

# Index

by item number

Item#	Page
10-17-8	36
10-18-8	36
10-26	36
10-35	36
10-47-2	13
10-47-6	13
10-55	13
10-55-24	13
8850	49
8851	49
8853	49
8854	49
8855	49
8856	50
8857	50
8858	50
8859	50
8860	50
8861	50
8862	51
8863	51
8864	51
8865	51
8866	51
10001	33
10002-6	32
10004	20
10005	27
10006	27
10007-12	22
10008-6	21
10012	33
10013	21
10014	21
10015	38
10020	33
10022	22
10026	27
10027	27
10029-15	11
10030	21
10031	22
10032	21
10033	25
10060	31

Item#	Page
10061	31
10062	31
10063	31
10064-8	31
10067	27
10068	27
10073	31
10074-8	31
10090	33
10091	22
10094-6	20
10095-6	38
10096	22
10117	18
10119	18
10214	18
10220	18
10267	19
10279	34
10281	27
10282	27
10284	27
10285	27
10286	27
10-303S	21
10316	27
10-321	21
10-323	21
10-331	21
10-452	36
10500	17
10-519	32
10552	17
10566	16
10568	16
10569	16
10600	17
10710	34
10800	17
13000	19
14000	18
19999-12	34

Item#	Page
20836-24	34
20900	23
21591	29
21643	13
21650	14
21660	14
21661	14
21661	15
22500	8
32010	20
32015-6	20
32025	20
38220	32
38221	32
38222	32
38223	32
38224	32
38776	21
42103	25
42105-12	25
42106-12	25
49708	24
49744	24
49989	24
50-540	35
50-545	35
50-550	35
50-555	35
50-560	35
50-565	35
50-570	35
60020	5
60083	7
60084A	9
60088	7
60089	8
60095	12
60098	12
60201	37
60311	33
60507	37
60510	37
6-1001CR	10

Item#	Page
6-1003CR	10
6-1005CR	10
61024	6
61205	15
61210	15
61605	37
61613	34
62413	31
62422	31
62900	23
62909	23
62960	23
63025	12
63030	12
6-4001CR	10
6-4003CR	10
6-4003SG	10
6-4003TB	10
6-4005CR	10
6-6012PW	11
6-7001CR	10
6-7003CR	10
6-7003SG	10
6-7003TB	10
6-7005CR	10
6-7006GL	10
6-8001CR	10
6-8003CR	10
6-8005CR	10
6-8038PW	11
70005	30
70007	30
70-010	40
70011B	30
70-025	40
70-100-1	39
70-100-12	39
70-115	41
70-120	41
70-125	30
70-130	41
70-140	41
70-145	41
70-150	41
70-160	41
70-170	41

Item#	Page
70-180	39
70-185	39
70-190	39
72000	40
72001	40
72004	40
72006	40
72025	40
75000-6	34
75001	15
75006K	23
76000	31
76030-12	30
78200	15
78201	15
78204HD	32
78208	15
78217	15
78300	15
79025	28
79630	28
79632	28
79635	29
79636	29
79637	29
79638	28
83200	4
83230	3
83240	2
92220	25
99600	38
99602	38
99702	26
99703	26
99720	26
99725	26
102023	48
102026	48
102042	48
102052	48
102056	48
102283	47

Item#	Page
A00005	48
A00204	47
A02116	45
A02277	43
A02285	47
A02420	46
A09033	45
A09267	42
A09272	42
A09552	42
A09590	46
A09614	44
A09615	45
A09616	45
A09620	44
A09626	43
A09627	43
A09628	43
A09640	48
A09644	48
A09650	48
A09656	48
A09658	48
A09661	43
A09663	43
A09690	44
A09694	46
A09695	44
A09706	44
A09712	45
A09714	45
A09750	48
A09790	45
A09796	45
A09798	46
A09802	47
A09807	47

# Index

by description

- B**  
Brick Cutters ..... 37  
Bridge Saws ..... 2-4  
Buckets ..... 15
- C**  
Carpet Groomer ..... 30  
Ceiling Installation ..... 49-51  
Cement Board  
Cutting Tools ..... 38, 46  
Screws ..... 38  
Tape ..... 38  
Chalk ..... 21  
Cheese Cloth ..... 30  
China Markers ..... 21  
Concrete Spreader ..... 37  
Contour Gauges ..... 21, 45  
Counter Brush ..... 33
- D**  
Diamond Blades ..... 10-11  
Drill Bits ..... 16, 21, 45
- F**  
Files ..... 22, 45  
Floats ..... 31, 43
- G**  
Grout & Tile Brush ..... 34, 47  
Grout Bag ..... 31  
Grout Saws ..... 33, 46  
Grout Sealer Bottles ..... 34, 47  
Grouting Gloves ..... 29
- H**  
Hammer, Magnetic ..... 37  
Hole Saws ..... 16, 44
- J**  
Jamb Saw ..... 13
- K**  
Kits ..... 32, 47  
Knee Pads ..... 28-29
- L**  
Laminate Installation  
Installation Kit ..... 36  
Laminate Cutters ..... 36  
Pull Bar ..... 36  
Tapping Block ..... 36  
Wedge Spacers ..... 36  
LASH Spacers ..... 26
- M**  
Mallet, White ..... 34  
Masonry Blades ..... 13  
Mixers ..... 14  
Mixing Paddles ..... 15
- N**  
Nippers ..... 20, 44
- P**  
Profile Wheels ..... 11  
Pliers ..... 20, 44  
Protective Film ..... 41
- S**  
Scrapers ..... 23  
Sealant Smoother ..... 47  
Spacers ..... 26-27, 48  
Sponges ..... 30, 48  
Suction Cups ..... 34, 48
- T**  
Tape  
Adhesive Strip ..... 35  
Duct Tape ..... 35  
Tile Cutter Replacement Wheels ..... 19  
Tile Cutters ..... 17-19, 42  
Tile Saw Accessories  
Laser Cutting Guide ..... 12  
Water Pumps ..... 12  
Work Lamp ..... 12  
Tile Saws ..... 2-9, 13  
Toilet Bowl Installation Kit ..... 32  
Trim Shears ..... 34  
Trowels ..... 24-25, 43
- U**  
Undercut Saw ..... 22  
Underlayment  
Cork ..... 40  
Felt ..... 39  
Foam ..... 39-40
- W**  
Waxed Paper ..... 41  
Wedges ..... 26-27

QEP®, Brutus® and Porcelain King® are registered trademarks of Q.E.P. Co., Inc.

LASH™ and Black Widow™ are trademarks of Q.E.P. Co., Inc.

Roberts®, Super Felt® and Floor Boar® are registered trademarks of Roberts Consolidated Industries, Inc. (a Q.E.P. Company)

Vitrex® is a registered trademark of Q.E.P. Co. U.K. Limited (a Q.E.P. Company)

johni-ring® is a registered trademark of Hercules Chemical Company, Inc.

Fluidmaster® is a registered trademark of Fluidmaster, Inc.

DUROCK® is a registered trademark of United States Gypsum Company

HardieBacker® is a registered trademark of James Hardie Technology Limited

VELCRO® is a registered trademark of Velcro Industries



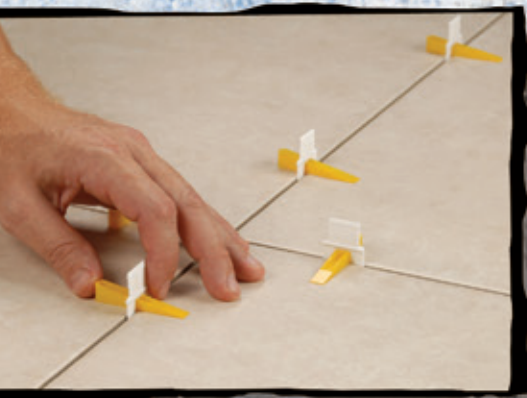

**corporate office**

**boca raton, florida**

1001 broken sound parkway, nw, suite A  
boca raton, fl 33487  
p 561.994.5550 f 561.241.2830

**canadian office**

**bramalea, ontario**

2070 steeles avenue  
bramalea, ontario, canada L6T1A7  
p 905.791.4444 f 905.791.1998

**[www.qep.com](http://www.qep.com)**



National  
Wood Flooring  
Association



QEP CATALOG 2011  
M0411-6029

**2011  
Edition**