



CLEANVIEW[®] Vacuum

USER GUIDE
2488, 2492, 2486 Series



More of a video person? Look for this icon and go online for an instructional how-to video at

www.BISSELL.com

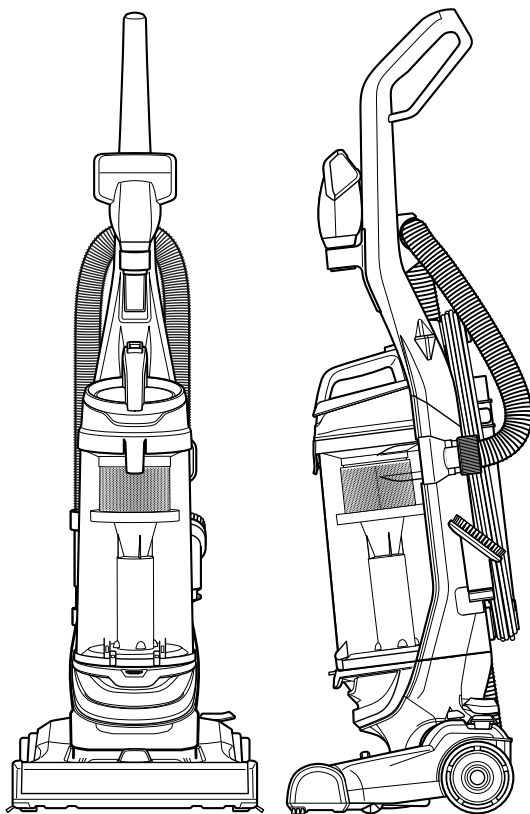

IMPORTANT SAFETY INSTRUCTIONS

READ ALL INSTRUCTIONS BEFORE USING YOUR UPRIGHT VACUUM.

Always connect to a polarized outlet (one slot is wider than the other). Unplug from outlet when not in use and before conducting maintenance. When using an electrical appliance, basic precautions should be observed, including the following:

⚠ WARNING

TO REDUCE THE RISK OF FIRE, ELECTRIC SHOCK OR INJURY:

- » Do not leave vacuum cleaner when it is plugged in. Unplug from outlet when not in use and before servicing.
- » Do not use outdoors or on wet surfaces.
- » Do not allow to be used as a toy. Close attention is necessary when used by or near children.
- » Do not use for any purpose other than described in this user guide. Use only manufacturer's recommended attachments.
- » Do not use with damaged cord or plug. If appliance is not working as it should, has been dropped, damaged, left outdoors, or dropped into water, have it repaired at an authorized service center.
- » Do not pull or carry by cord, use cord as a handle, close a door on cord, or pull cord around sharp edges or corners. Do not run appliance over cord. Keep cord away from heated surfaces.

- » Do not unplug by pulling on cord. To unplug, grasp the plug, not the cord.
- » Do not handle plug or vacuum cleaner with wet hands.
- » Do not put any object into openings. Do not use with any opening blocked; keep openings free of dust, lint, hair, and anything that may reduce air flow.
- » Keep hair, loose clothing, fingers, and all parts of body away from openings and moving parts.
- » Turn OFF all controls before plugging or unplugging vacuum cleaner.
- » Use extra care when cleaning on stairs.
- » Do not use to pick up flammable or combustible materials (lighter fluid, gasoline, kerosene, etc.) or use in areas where they may be present.
- » Do not use vacuum cleaner in an enclosed space filled with vapors given off by oil-based paint, paint thinner, some moth-proofing substances, flammable dust, or other explosive or toxic vapors.
- » Do not use to pick up toxic material (chlorine bleach, ammonia, drain cleaner, etc.).
- » Do not pick up anything that is burning or smoking, such as cigarettes, matches, or hot ashes.
- » Do not use without filters in place.
- » Do not pick up hard or sharp objects such as glass, nails, screws, coins, etc.
- » Use only on dry, indoor surfaces.
- » Keep appliance on a level surface.
- » Do not carry the vacuum cleaner while it is running.
- » Unplug before connecting or disconnecting the TurboBrush® Tool.

SAVE THESE INSTRUCTIONS

This model is for household use only.

⚠ WARNING

- » Before using your vacuum, make sure the Dirt Tank is in locked position and that all filters, both pre- and post-filters, are in place. **DO NOT** operate your vacuum without these filters.
- » Plastic film can be dangerous. To avoid danger of suffocation, keep away from children.
- » Do not plug in your vacuum UNTIL you are familiar with all instructions and operating procedures.
- » To reduce the risk of electrical shock, turn power switch OFF and disconnect polarized plug from electrical outlet BEFORE performing maintenance or troubleshooting checks.

THIS APPLIANCE HAS A POLARIZED PLUG

To reduce the risk of electric shock, this appliance has a polarized plug (one blade is wider than the other). This plug will fit in a polarized outlet only one way. If the plug does not fit fully in the outlet, reverse the plug. If it still does not fit, contact a qualified electrician to install a proper outlet. Do not change the plug in any way.

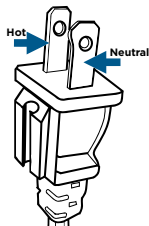

Thanks for buying a BISSELL® vacuum!

We love to clean and we're excited to share one of our innovative products with you. This guide has important instructions on how your new vacuum works, including using, maintaining, and if there is a problem, troubleshooting.

In just a few simple assembly steps, you'll be ready to vacuum. Flip to page 5 and let's get started!

What's In The Box?

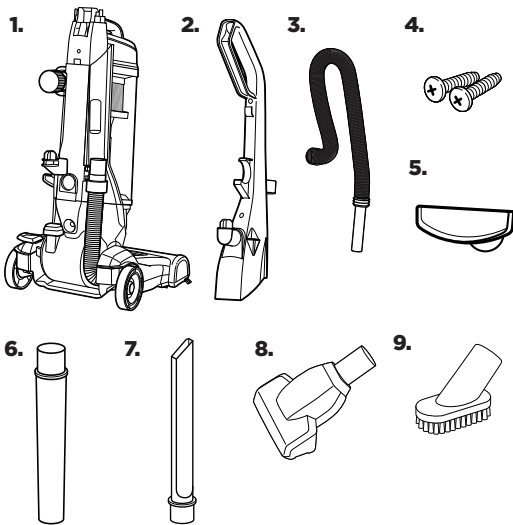

- 1. Vacuum Base
- 2. Handle
- 3. Hose
- 4. 2 Screws (taped to Handle)
- 5. Lower Cord Wrap
- 6. Extension Wand
- 7. Crevice Tool (stored inside Extension Wand)
- 8. TurboBrush® Tool
- 9. Dusting Brush

NOTE: Not all accessories come with every model. Be sure to check the carton for additional tools.

Safety Instructions.....	2	Troubleshooting	10
Product View.....	4	Warranty.....	11
Assembly	5	Service.....	11
Operations	6	Product Registration.....	12
Maintenance & Care	7-10	Parts & Supplies	12

Product View

⚠️ WARNING

Do not plug in your vacuum until you are familiar with all instructions and operating procedures.

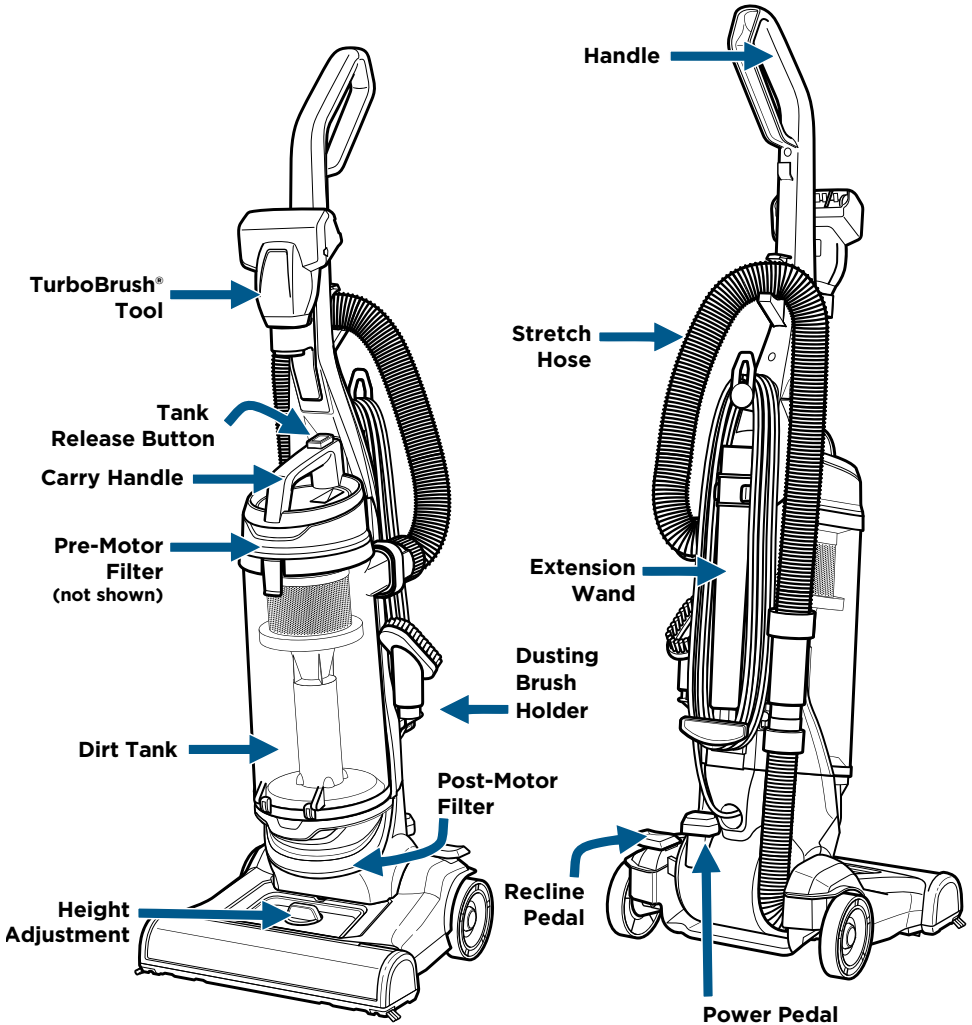

NOTE: The Crevice Tool is stored inside the Extension Wand.

Assembly

The only tool you will need to assemble your vacuum is a Phillips-head screwdriver.



1



Place the upper handle onto the base and push it down. Then attach the handle with the 2 screws taped to the handle in a plastic bag.

2

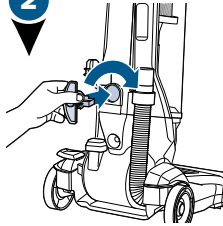

Insert the lower cord wrap and turn it to the right to lock in place.

3

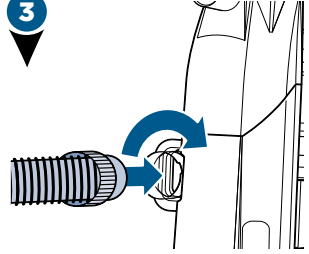

Insert the hose end into the back of the vacuum and twist right to lock in place.

4

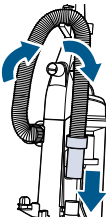

Wrap hose up and around the hose wrap on the handle. Slide end of hose into vacuum base.

5

Now, put your accessory tools on the vacuum and you're ready to go!

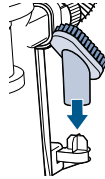

Dusting Brush

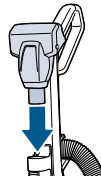

TurboBrush® Tool

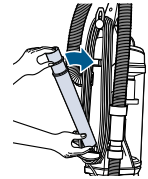



Extension Wand (Crevice Tool stores inside)

NOTE: The PowerFoot will not suction properly unless the hose is firmly attached.

Power ON & Settings

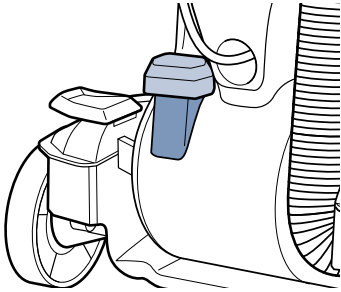
1



Press the red power button with your foot to turn the vacuum ON  and once again to turn your vacuum OFF .

2

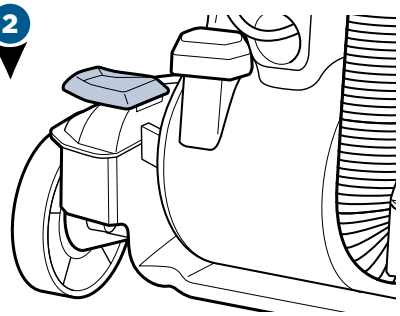

Press the recline pedal and pull handle back towards you.

3

high carpet

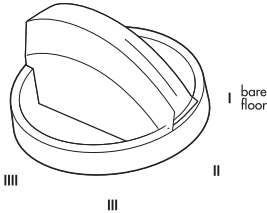

bare floor

Turn the dial on the foot of the vacuum to the desired setting. If the dial is difficult to turn, tilt the vacuum back slightly to take the weight off the foot while turning.

Lowest setting – For low pile carpet or bare floors. To pick up debris, it may be necessary to move up one setting.

Medium setting – For medium pile carpet.

Highest setting – For high pile and most shag carpet.

TIP: For optimal carpet cleaning performance, adjust to the lowest practical setting. If your vacuum is difficult to push, adjust to the next higher setting.

WARNING

To reduce the risk of injury from moving parts while the vacuum is turned ON, always move the vacuum via the rolling wheels by using the upper handle at the back of the vacuum. Do not carry the vacuum while it is running. Always place vacuum on floor with handle in upright position when using tools.

NOTE: Brush Roll continues to rotate while tools are in use. Never place fingers under the vacuum when it is running. Never place PowerFoot on furniture or uneven surfaces. Do not place vacuum close enough to objects to pull into rotating brush.

NOTE: Certain carpets and low humidity conditions may generate small static discharges. Static discharges are entirely harmless and are not associated in any way with the main power supply.

Empty the Dirt Tank

WARNING

To reduce the risk of electric shock, turn power switch OFF and disconnect polarized plug from electrical outlet before performing maintenance or troubleshooting checks.

1

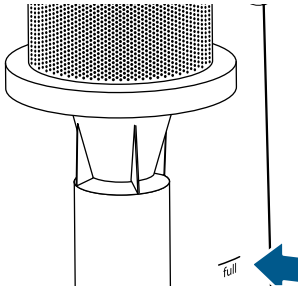

Empty once tank is full.

2

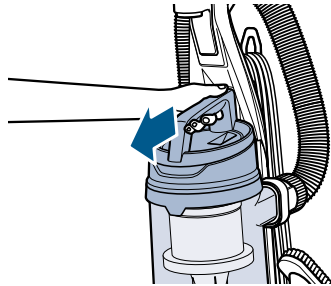

Press the tank release button and pull out to remove Dirt Tank.

3

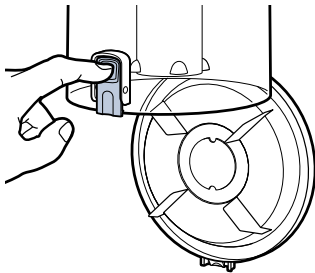

Hold the Dirt Tank over a trash container. Press the bottom release button to empty. Once empty, close the lid.

4

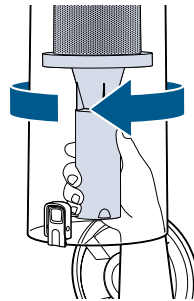

Twist cyclone left and pull down to remove from tank.

5

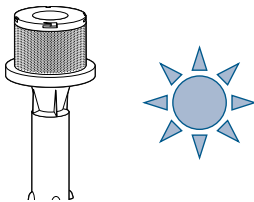

Clean cyclone with warm water and mild detergent. Let cyclone completely dry before replacing. To replace, fit into place and twist to the right.

6

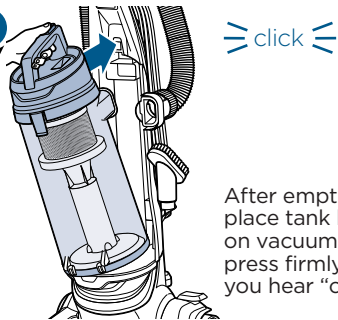

≡ click ≡

After emptied, place tank back on vacuum and press firmly until you hear "click".

NOTE: The Dirt Tank may be washed in warm water with a mild detergent. Make sure it is completely dry before replacing.

Clean the Pre-Motor Filter

WARNING

- » To reduce the risk of electric shock, turn power switch OFF and disconnect plug from electrical outlet before performing maintenance or troubleshooting checks.
- » Do not operate vacuum with damp or wet filters or without all filters in place.



1 Press the tank release button and pull out to remove Dirt Tank.

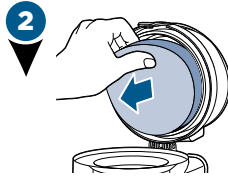

2 Remove foam filter from lid. Hand wash in warm water and rinse well; mild detergent may be used if desired.

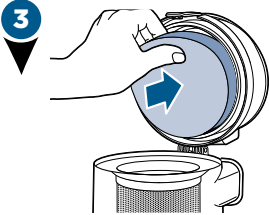

3 Allow filter to air dry completely before placing back into the tank lid.

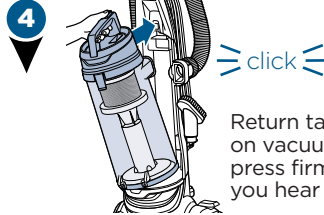

4 Return tank back on vacuum and press firmly until you hear "click".

NOTE: Replace this filter every 3 to 6 months. Search BISSELL.com for Style 1214.

Maintain the Post-Motor Filter



1 Recline vacuum and lay back for easier filter access.

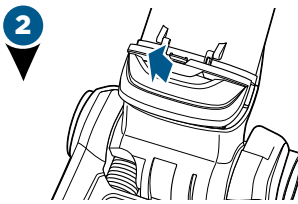

2 Located on the front of the vacuum above the foot height adjustment knob, remove the filter door by pushing down the latch and pulling the door out.

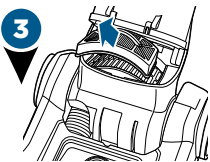

3 Remove the filter by grasping the sides of the filter and pulling out from the vacuum. Clean or replace filter as necessary.



4 Replace filter in unit and replace filter door by lining up the sides of the door and sliding into place until you hear a "click".

NOTE: Replace this filter every 3 to 6 months. Search BISSELL.com for Style 1526.

NOTE: The pleated post-motor filter may NOT be washed with water or detergent. If dust and/or debris accumulates on filter, gently tap the filter on the side of a garbage container.

Maintain the TurboBrush® Tool

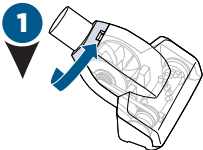

1
Twist gray collar counter-clockwise, until slot appears, then separate faceplate.

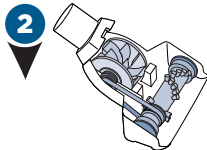

2
Remove Brush Roll, Belt and Paddle Wheel. Inspect for damages and replace if necessary.

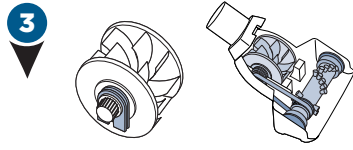

3
To reassemble, align two clips on each end of Paddle Wheel with Belt on and pop back into place. Place Brush Roll with belt back in. Faceplate will not close properly if all parts are not aligned correctly.

Replace Brush & Belt

⚠ WARNING To reduce the risk of electric shock, turn power switch OFF and disconnect plug from electrical outlet before performing maintenance or troubleshooting checks.

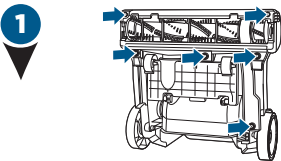

1
Unplug vacuum, turn over and unscrew six (6) Phillips-head screws to remove the bottom cover. Lift brush straight out.



2
Clean debris from Brush Roll. Inspect by placing on its end and spin. The Brush Roll should spin freely, multiple times by one flick. If it doesn't, replace Brush Roll. Check Belt for wear or cuts and replace if necessary.

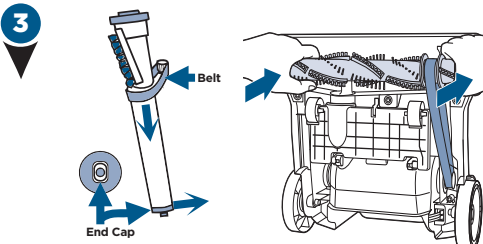

3
Replace the Brush Roll and Belt by looping the belt over the motor shaft and the Brush Roll. Line up the end caps and pull the brush forward into place. This will stretch the Belt. Return bottom cover back on and replace the screws.

Clearing a Clog

⚠ WARNING To reduce the risk of electric shock, turn power switch OFF and disconnect plug from electrical outlet before performing maintenance or troubleshooting checks.

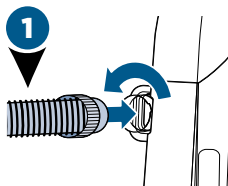

1
Remove the hose from the back of the vacuum by twisting it to the left. Remove any debris that may have gotten clogged.

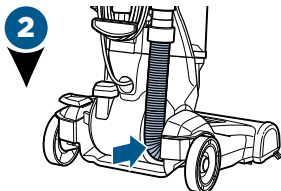

2
Check the foot hose on the back of your vacuum down towards the bottom. If necessary, remove the screw from the foot hose and check for clogs.

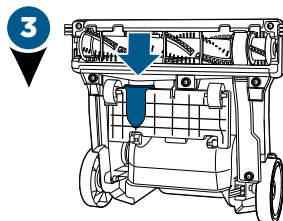

3
Check the air passageway on the bottom of your vacuum. Remove the bottom cover and the brush. Remove any debris.

Troubleshooting

Problem	Possible Causes	Remedies
Vacuum won't turn on	Power cord not plugged in	Check electrical plug
	Blown fuse/tripped breaker	Check/replace fuse or reset breaker
Vacuum won't pick up dirt	Incorrect height adjustment	Adjust foot to correct height setting
	Hose not attached to suction opening	Grasp the hose wand and firmly push into the hose wand base
	Crack or hole in hose	Check hose and replace if needed
	Broken or worn drive belt	Replace drive belt, see page 9
	Brush roll jammed	Remove brush and clean debris from brush ends, see page 9
	Clog in vacuum	Check for debris build-up or clogs in the inner tank, hose and foot/lower hose; See online video for more help
	Dirt Tank full	Empty Dirt Tank
	Dirt Tank or upper tank not installed properly	Position correctly and lock in place, see page 7
	Filters are dirty	Check and clean or replace pre-motor and post-motor filters, see page 8
Tool won't pick up	Crack or hole in hose	Check hose and replace if needed
	Clog in vacuum	Check for debris build-up or clogs in the inner tank, hose and foot/lower hose; See online video for more help
	Dirt Tank full	Empty Dirt Tank
	Dirt Tank or upper tank not installed properly	Position correctly and lock in place, see page 7
	Filters are dirty	Check and clean or replace pre-motor and post-motor filters, see page 8
Vacuum difficult to push	Incorrect height adjustment	Adjust foot to correct height setting, see page 6
Visible dirt escaping from vacuum	Dirt Tank full	Empty Dirt Tank
	Filters missing or installed incorrectly	Check pre-motor and post-motor filters for correct installation, see page 8

Warranty

This warranty gives you specific legal rights, and you may also have other rights which may vary from state to state. If you need additional instruction regarding this warranty or have questions regarding what it may cover, please contact BISSELL Consumer Care by E-mail or telephone as described below.

It may be necessary to obtain some of your personal information, such as a mailing address, to fulfill terms of this warranty. Any personal data will be handled pursuant to BISSELL's Privacy Policy, which can be found online at www.BISSELL.com/privacy-policy.

Limited Two-Year Warranty

Subject to the ***Exceptions and Exclusions from the Terms of the Limited Warranty**, upon receipt of the product BISSELL will repair or replace (with new, refurbished, lightly used, or remanufactured components or products), at BISSELL's option, free of charge from the date of purchase by the original purchaser, for two years, any defective or malfunctioning part.

See information below on "If your BISSELL product should require service".

This warranty applies to product used for personal, and not commercial or rental, service. This warranty does not apply to fans or routine maintenance components

such as filters, belts or brushes. Damage or malfunction caused by negligence, abuse, neglect, unauthorized repair, or any other use not in accordance with the user guide is not covered. This warranty will only be valid if the product is used in the same country in which it was sold.

BISSELL is not liable for incidental or consequential damages of any nature associated with the use of this product. BISSELL's liability will not exceed the purchase price of the product.

Some states do not allow the exclusion or limitation of incidental or consequential damages, so the above limitation or exclusion may not apply to you.

*Exceptions and Exclusions from the Terms of the Limited Warranty

This warranty is exclusive and in lieu of any other warranties, either oral or written. Any implied warranties, which may arise by operation of law, including the implied warranties of merchantability and fitness for a particular purpose, are limited to the two-year duration from the date of purchase as described above.

Some states do not allow limitations on how long an implied warranty lasts, so the above limitation may not apply to you.

NOTE: Please keep your original sales receipt. It provides proof of date of purchase in the event of a warranty claim.

Service

Please do not return this product to the store.

Other maintenance or service not included in the manual should be performed by an authorized service representative.

If your BISSELL product should require service:

Contact BISSELL Consumer Care to locate a BISSELL Authorized Service Center in your area. If you need information about repairs or replacement parts, or if you have questions about your warranty, contact BISSELL Consumer Care.

Website:

www.BISSELL.com/service-centers

E-mail:

www.BISSELL.com/email-us

Call:

BISSELL Consumer Care
1-800-237-7691

Monday – Friday: 8am - 10pm ET

Saturday: 9am - 8pm ET

Sunday: 10am - 7pm ET

Register your product today!

Registering is quick, easy and offers you benefits over the lifetime of your product.

You'll receive:

BISSELL® Rewards Points

Automatically earn points for discounts and free shipping on future purchases.

Faster Service

Supplying your information now saves you time should you need to contact us with questions regarding your product.

Product Support Reminders and Alerts

We'll contact you with any important product maintenance reminders and alerts.

Special Promotions

Optional: Register your email to receive notice of offers, contests, cleaning tips and more!

Visit www.BISSELL.com/registration!

Visit the BISSELL website: www.BISSELL.com

When contacting BISSELL, have model number of cleaner available.

Please record your Model Number: _____

Please record your Purchase Date: _____

NOTE: Please keep your original sales receipt. It provides proof of purchase date in the event of a warranty claim. See Warranty page for details.

Parts & Supplies

For Parts and Supplies, go to www.BISSELL.com and enter your model number in the search field.

We can't wait to hear from you!

Rate this product and let us (and millions of your closest friends) know what you think!

www.BISSELL.com



©2018 BISSELL Homecare, Inc.
Grand Rapids, Michigan
All rights reserved. Printed in China
Part Number 161-7364 09/18 RevA
Visit our website at: www.BISSELL.com