



YOUR
complete
SOLUTION

REDISCOVER ALLISON™





Selecting the finishing touch shouldn't be **complicated...**

Unfortunately, it has been **until now.**

You don't have to sacrifice **trend-inspired style.** Ideal for **residential** or **commercial** applications, Allison marries beauty and function. It's the best combination of **approachable artistry** and **lasting quality.**

Leave builder-basic behind in favor of something **unique** and **on-trend.** **Set yourself apart with Allison™.**



COLLECTION:
Allison™ BP11287
and BP22439

FINISH:
Matte Black

A growing selection of **unique, on-trend** styles and finishes.

Amerock has answered the call for **streamlined, uncomplicated options**. Allison focuses on **core**, approachable styles. Every Allison item is available in four **on-trend** finishes for **effortless selection**.

BRAND NEW STYLES

Continuing with the popularity of **contemporary** and **transitional** styles, Amerock has introduced brand new styles and will **continue to expand** our trend-right offering.



FINISHES IN VOGUE

In addition to providing **Matte Black** options, stay tuned as Amerock will introduce a complementing finish for Delta's popular **Champagne Bronze**.

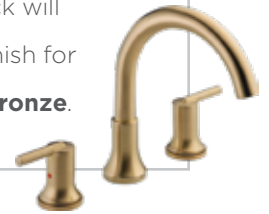

Trinsic by Delta



NEW!
1-1/4in (32mm)
LGTH Knob
BP11287



NEW!
5-1/16in (128mm)
CTC Cup Pull
BP22439



NEW!
3in (76mm)
CTC Pull
BP21935



NEW!
3in (76mm) CTC
Stem-Free Cup Pull
BP22094

EXPANDED FINISHES

For a streamlined selection, we've **extended** the finish offering in four popular collections to include **Polished Chrome** and **Matte Black**.*



GRANBY



MONUMENT



EXTENSITY



EDGE PULLS

*Knobs & pulls up to 6-5/16in (160mm) CTC. New finishes not available in appliance pulls.

AVAILABLE FINISHES

- Polished Chrome (26)
- Satin Nickel (G10)
- Oil-Rubbed Bronze (ORB)
- Matte Black (FB)



HARDWARE INCLUDED

See p. 7 for installation hardware included with each product.

Contemporary



Shown in Polished Chrome

NEW FINISHES

- Polished Chrome
- Matte Black

COMING SOON

- Champagne Bronze

Type	Product Detail in (mm)	Part Number	US MSRP (CA MSRP)
Knobs	1-1/8 (29) LGTH	① BP29370	\$3.99 (\$4.59)
	1-1/2 (38) LGTH	BP29398	\$7.99 (\$9.19)
Pulls	4-1/8 (105) LGTH 3 (76) CTC	② BP29379	\$4.99 (\$5.74)
	4-15/16 (125) LGTH 3-3/4 (96) CTC	BP29385	\$5.99 (\$6.89)
	6-1/4 (159) LGTH 5-1/16 (128) CTC	BP29393	\$6.99 (\$8.04)
	7-1/2 (191) LGTH 6-5/16 (160) CTC	BP29394	\$8.99 (\$10.04)

Additional finishes available beyond four finishes noted at top of page. Appliance Pulls available. See Amerock.com or catalog.



Shown in Matte Black

NEW FINISHES

- Polished Chrome
- Matte Black

COMING SOON

- Champagne Bronze

Type	Product Detail in (mm)	Part Number	US MSRP (CA MSRP)
Pulls	4-1/8 (105) LGTH 3-3/4 (96) CTC	① BP36570	\$8.99 (\$10.34)
	5-7/16 (138) LGTH 5-1/16 (128) CTC	② BP36571	\$10.99 (\$12.64)
	6-11/16 (170) LGTH 6-5/16 (160) CTC	BP36572	\$12.99 (\$14.94)

Additional finish available beyond four finishes noted at top of page.

LONGER LENGTHS

Following the trend of increasing cabinet sizes, **extended pull lengths** will soon be available.



See index on p. 14 for full product numbers. Pricing subject to change.

Contemporary



Shown in Matte Black

NEW FINISHES

- Polished Chrome
- Matte Black

Type	Product Detail in (mm)	Part Number	US MSRP (CA MSRP)
Edge Pulls	3-13/16 (97) LGTH 3 (76) CTC	1 BP36573	\$6.99 (\$8.04)
	4-9/16 (116) LGTH 3-3/4 (96) CTC	2 BP36574	\$8.99 (\$10.34)
	5-13/16 (148) LGTH 5-1/16 (128) CTC	BP36575	\$10.99 (\$12.64)

Additional finish available beyond four finishes noted at top of p. 4.



Shown in Polished Chrome

Type	Product Detail in (mm)	Part Number	US MSRP (CA MSRP)
Knob	1-3/8 (35) LGTH	1 BP53014	\$2.99 (\$3.44)
Pull	4-13/16 (122) LGTH 3-3/4 (96) CTC	2 BP53003	\$3.29 (\$3.78)

Transitional/Traditional



Shown in Matte Black

COMING SOON

- Champagne Bronze

Type	Product Detail in (mm)	Part Number	US MSRP (CA MSRP)
Knob	1-1/4 (32) LGTH	1 NEW! BP11287	\$3.99 (\$4.59)
Pull	6-3/8 (162) LGTH 5-1/16 (128) CTC	2 NEW! BP22439	\$5.99 (\$6.89)

EXTENDED LENGTH

Get the **unique appeal** of a cup pull with the versatility of a **longer length**.



HASSLE-FREE INSTALLATION

No stem means this cup pull **mounts flush** without counterbore drilling.

See index on p. 14 for full product numbers. Pricing subject to change.

AVAILABLE FINISHES

- Polished Chrome (26)
- Satin Nickel (G10)
- Oil-Rubbed Bronze (ORB)
- Matte Black (FB)



HARDWARE INCLUDED

See opposite page for installation hardware included with each product.

Transitional/Traditional



Shown in Matte Black

Type	Product Detail in (mm)	Part Number	US MSRP (CA MSRP)
Knob	1-1/4 (32) DIA	1 BP53012	\$2.59 (\$2.98)
Pull	5 (127) LGTH 3 (76) CTC	2 NEW! BP21935	\$2.70 (\$3.11)
Cup Pull	3-11/16 (94) LGTH 3 (76) CTC	3 NEW! BP22094	\$4.25 (\$4.89)

Knob available in additional finishes beyond those noted at top of page.

HASSLE-FREE INSTALLATION

No stem means this cup pull mounts flush without counterbore drilling.



Shown in Polished Chrome

NEW FINISHES

- Polished Chrome
- Matte Black

Type	Product Detail in (mm)	Part Number	US MSRP (CA MSRP)
Knob	1-1/4 (32) DIA	1 BP53005	\$1.99 (\$2.29)
Pulls	3-3/8 (86) LGTH 3 (76) CTC	2 BP53013	\$2.99 (\$3.44)
	4-3/16 (106) LGTH 3-3/4 (96) CTC	BP55243	\$4.99 (\$5.74)
	5-9/16 (141) LGTH 5-1/16 (128) CTC	BP55244	\$5.99 (\$6.89)
	6-7/8 (175) LGTH 6-5/16 (160) CTC	BP55245	\$8.99 (\$10.34)

Additional finish available beyond four finishes noted at top of page.
Appliance Pulls available. See Amerock.com or catalog.

See index on p. 14 for full product numbers. Pricing subject to change.

Installation Hardware

The following installation hardware is included with each Allison product.

Knobs

(1) #8-32 x 1in T.H. Machine Screw

Pulls

(2) #8-32 x 1in T.H. Machine Screw

Cup Pulls

(2) #8-32 x 1in T.H. Machine Screw



COLLECTION:
Monument

FINISH:
Matte Black



Take the **guesswork** out of selecting cabinet hardware.

ALLISON MERCHANDISING

You can showcase the Allison styles and finishes you've seen in this booklet with Amerock's **MSRP Group 1** merchandising options.





A useful **selling tool** shows suggested pairings of Allison finishes and popular cabinet colors.

Eliminate the pain point of **price shopping**. Part numbers and other SKU specific details appear only in the **product map** on the back of the board. The product map is also available for printing.

To keep the display organized, a **green dot** appears on the **back** of each item.



A row of chips shows the Allison finishes available for every item:

-  **Polished Chrome**
-  **Satin Nickel**
-  **Oil-Rubbed Bronze**
-  **Matte Black**

Mounting hardware is **included** for sheetrock or slat wall.

INTERACTIVE BOARD OPTION

Amerock's new patent-pending **Interactive merchandising solution** allows customers to easily remove hardware from the board and **visualize it directly** on their cabinet selection.





STATIC BOARD OPTION

This elegant **white gloss** display board features **non-removable hardware** for those preferring a static option.

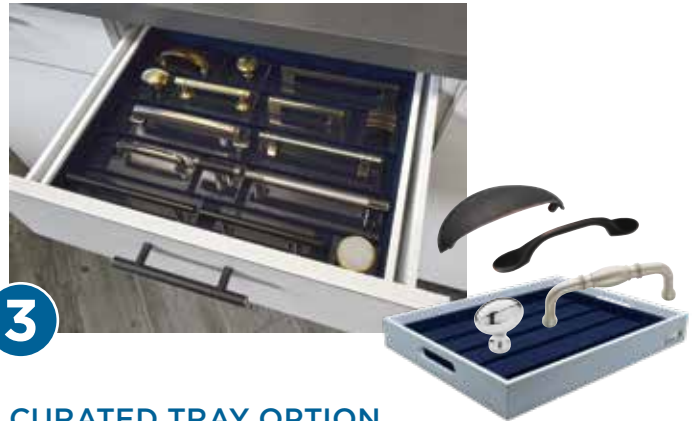

CURATED TRAY OPTION

Maximize the versatility of the hardware on your Interactive or Static board, or complement an existing display tower. The tray can also fit into existing vignettes.

More ways to **increase profitability.**



ADDITIONAL MSRP GROUPS

If you'd like to offer more options, choose from **three additional MSRP groups** that feature our top collections in on-trend finishes, including **gold** and **polished nickel**.



LUXURY CONTEMPORARY

Don't miss the movement — contemporary style is red-hot. Amerock now offers an Interactive, Static & Tray option for our new **Euro Contemporary collections**.

Contact your Amerock sales rep to learn more about our merchandising options.

On-Trend Finish and Cabinet Color Pairings

Eliminate the pain point of coordinating on-trend Allison finishes with popular cabinet colors.



LIGHT/MEDIUM GREY

26 G10 ORB FB



CREAM

26 G10 ORB FB



DARK GREY

26 G10

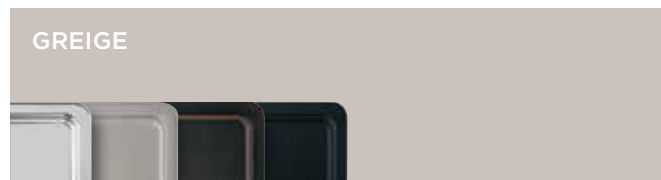

GREIGE

26 G10 ORB FB

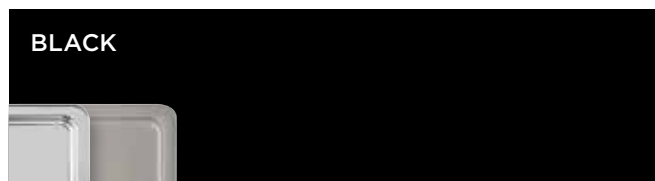

BLACK

26 G10



NAVY

26 G10

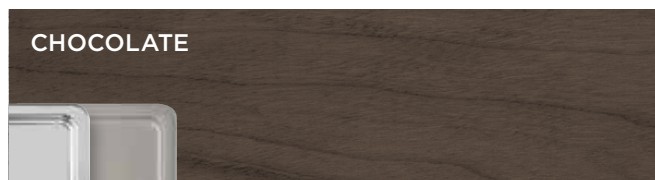

CHOCOLATE

26 G10



MEDIUM BROWN

26 G10 ORB FB

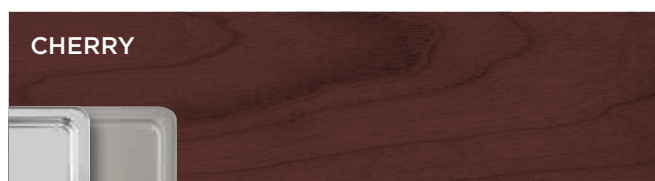

CHERRY

26 G10

ON-TREND FINISHES

-  Polished Chrome (26)
-  Satin Nickel (G10)
-  Oil-Rubbed Bronze (ORB)
-  Matte Black (FB)

Aligning with **top players** in the kitchen and bath industry.

Earn **0.1 CEU** in our new webinar **certified by the NKBA**. Our own principal designer Peter Wells walks you through the architectural styles and eras that are influencing decorative hardware.

Find Amerock's course online at nkba.org/amerock



Amerock is the right choice for **designers** and **builders**.

Professional **design software** partnerships make selecting the right Amerock product even easier.



For details, visit **Amerock.com** and select *Support*, then *Software Guides: How To Find Us*.



To find our selection of products **available in versions 11.9 and up**, simply select a cabinet or drawer item that you've added to your design, select the *Items* ribbon, click *Styles & Pricing* and select the *Catalog Styles* tab.



To find our selection of products **available in Envision design software**, click the *View Products* link in the *Global Navigation Bar*. You can then link products to your project by using the *Options Manager*.

Complementing Plumbing Finish Matrix

Identify the cabinet hardware finishes that **best complement** well-known plumbing brand finishes.

AMEROCK CABINET HARDWARE FINISH	KOHLER	DELTA	MOEN
 Polished Chrome (26)	Polished Chrome	Chrome	Chrome
 Satin Nickel (G10)	Vibrant Brushed Nickel	Brilliance® Stainless	Brushed Nickel
 Oil-Rubbed Bronze (ORB)	Oil-Rubbed Bronze	Oil-Rubbed Bronze	Mediterranean Bronze
 Matte Black (FB)	Matte Black	Matte Black	Matte Black



Think **outside** the kitchen and bath.

WHOLE-HOME SOLUTION

In today's open-concept home, **cabinets** live **beyond** just the kitchen and bath.

Creating a cohesive look across **master closets, mud rooms** and **laundry rooms** is highly desirable — and the demand for coordinating cabinet hardware means more **opportunity for profit**.

GET YOUR CUSTOMERS HOOKED

Amerock answers the need for versatile, functional spaces with a variety of **hooks** — and even more opportunities to **increase your profitability**.



More reasons Amerock is the **right choice.**

LIFETIME WARRANTY

All Amerock **Cabinet Hardware, Bath Accessories** and **Wall Plates** are protected against defect in material and workmanship.



See Amerock.com for full warranty statement.

IMAP POLICY

Amerock unilaterally has implemented an **Internet Minimum Advertised Price (IMAP)** policy for all active products. Amerock will conduct business solely with dealers and retailers who choose to advertise Amerock products in accordance with the policy.

FREE SAMPLES

Our free samples program takes the guesswork out of specifying hardware. **See and feel** our products for yourself before making a final decision.



Fulfillment the way it **should be.**

Amerock is now partnering with UPS Supply Chain Solutions to develop and deliver best-in-class logistics service.

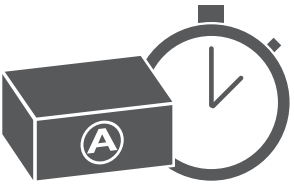

- ✓ Repositioned distribution footprint to improve national ground transit times.
- ✓ Ability to grow and scale with a flexible and configurable solution to meet evolving customer needs.
- ✓ Full-suite logistical services to better serve our customers nationally and globally.

Get **social** with Amerock.

Stay up to date with the latest **product, trends, kitchen and bath design news** and **tips and tricks.**

REFERENCE DRAWINGS

Symbol	Description
L	Length
W	Width
P	Projection
C	Center-to-Center
BL	Base Length
BW	Base Width

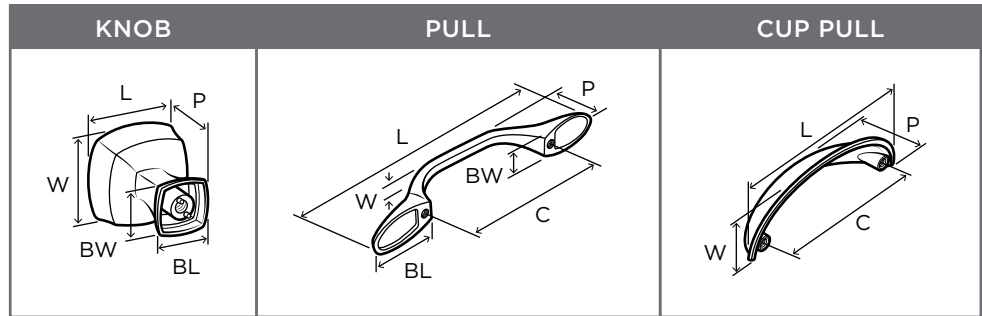

PRODUCT INDEX

Product No.	US MSRP (CA MSRP)	Type	Finish	Product Detail in(mm)	Length in(mm)	Width in(mm)	Projection in(mm)	Base Dimensions in(mm)	Base Material	Shelf / Master Pack QTY
BP1128726	\$3.99 (\$4.59)	Knob	Polished Chrome	1-1/4 (32) LGTH	1-1/4 (32)	1-1/4 (32)	1-1/4 (32)	9/16 L x 9/16 W (14 L x 14 W)	Zinc	10 / 120
BP11287FB	\$3.99 (\$4.59)	Knob	Matte Black	1-1/4 (32) LGTH	1-1/4 (32)	1-1/4 (32)	1-1/4 (32)	9/16 L x 9/16 W (14 L x 14 W)	Zinc	10 / 120
BP11287G10	\$3.99 (\$4.59)	Knob	Satin Nickel	1-1/4 (32) LGTH	1-1/4 (32)	1-1/4 (32)	1-1/4 (32)	9/16 L x 9/16 W (14 L x 14 W)	Zinc	10 / 120
BP11287ORB	\$3.99 (\$4.59)	Knob	Oil-Rubbed Bronze	1-1/4 (32) LGTH	1-1/4 (32)	1-1/4 (32)	1-1/4 (32)	9/16 L x 9/16 W (14 L x 14 W)	Zinc	10 / 120
BP2193526	\$2.70 (\$3.11)	Pull	Polished Chrome	3(76) CTC	5 (127)	11/16 (17)	1 (25)	1-1/8 L x 11/16 W (29 L x 17 W)	Zinc	10 / 100
BP21935FB	\$2.70 (\$3.11)	Pull	Matte Black	3(76) CTC	5 (127)	11/16 (17)	1 (25)	1-1/8 L x 11/16 W (29 L x 17 W)	Zinc	10 / 100
BP21935G10	\$2.70 (\$3.11)	Pull	Satin Nickel	3(76) CTC	5 (127)	11/16 (17)	1 (25)	1-1/8 L x 11/16 W (29 L x 17 W)	Zinc	10 / 100
BP21935ORB	\$2.70 (\$3.11)	Pull	Oil-Rubbed Bronze	3(76) CTC	5 (127)	11/16 (17)	1 (25)	1-1/8 L x 11/16 W (29 L x 17 W)	Zinc	10 / 100
BP2209426	\$4.25 (\$4.89)	Pull	Polished Chrome	3(76) CTC	3-11/16 (94)	1-1/4 (32)	1-1/8 (29)	3-11/16 L x 1-1/4 W (94 L x 32 W)	Zinc	10 / 100
BP22094FB	\$4.25 (\$4.89)	Pull	Matte Black	3(76) CTC	3-11/16 (94)	1-1/4 (32)	1-1/8 (29)	3-11/16 L x 1-1/4 W (94 L x 32 W)	Zinc	10 / 100
BP22094G10	\$4.25 (\$4.89)	Pull	Satin Nickel	3(76) CTC	3-11/16 (94)	1-1/4 (32)	1-1/8 (29)	3-11/16 L x 1-1/4 W (94 L x 32 W)	Zinc	10 / 100
BP22094ORB	\$4.25 (\$4.89)	Pull	Oil-Rubbed Bronze	3(76) CTC	3-11/16 (94)	1-1/4 (32)	1-1/8 (29)	3-11/16 L x 1-1/4 W (94 L x 32 W)	Zinc	10 / 100
BP2243926	\$5.99 (\$6.89)	Pull	Polished Chrome	5-1/16 (128) CTC	6-3/8 (162)	1-5/16 (34)	15/16 (24)	6-3/8 L x 1-5/16 W (162 L x 33 W)	Zinc	10 / 120
BP22439FB	\$5.99 (\$6.89)	Pull	Matte Black	5-1/16 (128) CTC	6-3/8 (162)	1-5/16 (34)	15/16 (24)	6-3/8 L x 1-5/16 W (162 L x 33 W)	Zinc	10 / 120
BP22439G10	\$5.99 (\$6.89)	Pull	Satin Nickel	5-1/16 (128) CTC	6-3/8 (162)	1-5/16 (34)	15/16 (24)	6-3/8 L x 1-5/16 W (162 L x 33 W)	Zinc	10 / 120
BP22439ORB	\$5.99 (\$6.89)	Pull	Oil-Rubbed Bronze	5-1/16 (128) CTC	6-3/8 (162)	1-5/16 (34)	15/16 (24)	6-3/8 L x 1-5/16 W (162 L x 33 W)	Zinc	10 / 120
BP2937026	\$3.99 (\$4.59)	Knob	Polished Chrome	1-1/8(29) LGTH	1-1/8(29)	1-1/8(29)	1-1/16(27)	5/16(8) DIA	Zinc	10 / 120
BP29370FB	\$3.99 (\$4.59)	Knob	Matte Black	1-1/8(29) LGTH	1-1/8(29)	1-1/8(29)	1-1/16(27)	5/16(8) DIA	Zinc	10 / 120
BP29370G10	\$3.99 (\$4.59)	Knob	Satin Nickel	1-1/8(29) LGTH	1-1/8(29)	1-1/8(29)	1-1/16(27)	5/16(8) DIA	Zinc	10 / 120
BP29370ORB	\$3.99 (\$4.59)	Knob	Oil-Rubbed Bronze	1-1/8(29) LGTH	1-1/8(29)	1-1/8(29)	1-1/16(27)	5/16(8) DIA	Zinc	10 / 120
BP2937926	\$4.99 (\$5.74)	Pull	Polished Chrome	3(76) CTC	4-1/8(105)	11/16(17)	1-5/16(33)	5/16(8) DIA	Zinc	10 / 120
BP29379FB	\$4.99 (\$5.74)	Pull	Matte Black	3(76) CTC	4-1/8(105)	11/16(17)	1-5/16(33)	5/16(8) DIA	Zinc	10 / 120
BP29379G10	\$4.99 (\$5.74)	Pull	Satin Nickel	3(76) CTC	4-1/8(105)	11/16(17)	1-5/16(33)	5/16(8) DIA	Zinc	10 / 120
BP29379ORB	\$4.99 (\$5.74)	Pull	Oil-Rubbed Bronze	3(76) CTC	4-1/8(105)	11/16(17)	1-5/16(33)	5/16(8) DIA	Zinc	10 / 120
BP2938526	\$5.99 (\$6.89)	Pull	Polished Chrome	3-3/4(96) CTC	4-15/16(125)	11/16(17)	1-5/16(33)	5/16(8) DIA	Zinc	10 / 120
BP29385FB	\$5.99 (\$6.89)	Pull	Matte Black	3-3/4(96) CTC	4-15/16(125)	11/16(17)	1-5/16(33)	5/16(8) DIA	Zinc	10 / 120
BP29385G10	\$5.99 (\$6.89)	Pull	Satin Nickel	3-3/4(96) CTC	4-15/16(125)	11/16(17)	1-5/16(33)	5/16(8) DIA	Zinc	10 / 120
BP29385ORB	\$5.99 (\$6.89)	Pull	Oil-Rubbed Bronze	3-3/4(96) CTC	4-15/16(125)	11/16(17)	1-5/16(33)	5/16(8) DIA	Zinc	10 / 120
BP2939326	\$6.99 (\$8.04)	Pull	Polished Chrome	5-1/16(128) CTC	6-1/4(159)	11/16(17)	1-7/16(37)	5/16(8) DIA	Zinc	10 / 80
BP29393FB	\$6.99 (\$8.04)	Pull	Matte Black	5-1/16(128) CTC	6-1/4(159)	11/16(17)	1-7/16(37)	5/16(8) DIA	Zinc	10 / 80
BP29393G10	\$6.99 (\$8.04)	Pull	Satin Nickel	5-1/16(128) CTC	6-1/4(159)	11/16(17)	1-7/16(37)	5/16(8) DIA	Zinc	10 / 80
BP29393ORB	\$6.99 (\$8.04)	Pull	Oil-Rubbed Bronze	5-1/16(128) CTC	6-1/4(159)	11/16(17)	1-7/16(37)	5/16(8) DIA	Zinc	10 / 80
BP2939426	\$8.99 (\$10.34)	Pull	Polished Chrome	6-5/16(160) CTC	7-1/2(191)	11/16(17)	1-1/2(38)	5/16(8) DIA	Zinc	10 / 80
BP29394FB	\$8.99 (\$10.34)	Pull	Matte Black	6-5/16(160) CTC	7-1/2(191)	11/16(17)	1-1/2(38)	5/16(8) DIA	Zinc	10 / 80
BP29394G10	\$8.99 (\$10.34)	Pull	Satin Nickel	6-5/16(160) CTC	7-1/2(191)	11/16(17)	1-1/2(38)	5/16(8) DIA	Zinc	10 / 80
BP29394ORB	\$8.99 (\$10.34)	Pull	Oil-Rubbed Bronze	6-5/16(160) CTC	7-1/2(191)	11/16(17)	1-1/2(38)	5/16(8) DIA	Zinc	10 / 80
BP2939826	\$7.99 (\$9.19)	Knob	Polished Chrome	1-1/2(38) LGTH	1-1/2(38)	1-1/2(38)	1-1/8(29)	5/16(8) DIA	Zinc	10 / 120
BP29398FB	\$7.99 (\$9.19)	Knob	Matte Black	1-1/2(38) LGTH	1-1/2(38)	1-1/2(38)	1-1/8(29)	5/16(8) DIA	Zinc	10 / 120
BP29398G10	\$7.99 (\$9.19)	Knob	Satin Nickel	1-1/2(38) LGTH	1-1/2(38)	1-1/2(38)	1-1/8(29)	5/16(8) DIA	Zinc	10 / 120
BP29398ORB	\$7.99 (\$9.19)	Knob	Oil-Rubbed Bronze	1-1/2(38) LGTH	1-1/2(38)	1-1/2(38)	1-1/8(29)	5/16(8) DIA	Zinc	10 / 120
BP3657026	\$8.99 (\$10.34)	Pull	Polished Chrome	3-3/4(96) CTC	4-1/8(105)	3/8(10)	1-3/16(30)	3/8 L x 3/8 W (10 L x 10 W)	Aluminum	20 / 200
BP36570FB	\$8.99 (\$10.34)	Pull	Matte Black	3-3/4(96) CTC	4-1/8(105)	3/8(10)	1-3/16(30)	3/8 L x 3/8 W (10 L x 10 W)	Aluminum	20 / 200
BP36570G10	\$8.99 (\$10.34)	Pull	Satin Nickel	3-3/4(96) CTC	4-1/8(105)	3/8(10)	1-3/16(30)	3/8 L x 3/8 W (10 L x 10 W)	Aluminum	20 / 200
BP36570ORB	\$8.99 (\$10.34)	Pull	Oil-Rubbed Bronze	3-3/4(96) CTC	4-1/8(105)	3/8(10)	1-3/16(30)	3/8 L x 3/8 W (10 L x 10 W)	Aluminum	20 / 200

Prices subject to change, and effective 10/1/19. Mounting hardware included.
The dimensional information provided here should be verified with the actual product prior to drilling or attempting to install the hardware.
Please direct any questions you may have on the installation process to Amerock Customer Service (see back cover for contact information).

PRODUCT INDEX

Product No.	US MSRP (CA MSRP)	Type	Finish	Product Detail in(mm)	Length in(mm)	Width in(mm)	Projection in(mm)	Base Dimensions in(mm)	Base Material	Shelf / Master Pack QTY
BP3657126	\$10.99 (\$12.64)	Pull	Polished Chrome	5-1/16(128) CTC	5-7/16(138)	3/8(10)	1-3/16(30)	3/8 L x 3/8 W (10 L x 10 W)	Aluminum	20 / 200
BP36571FB	\$10.99 (\$12.64)	Pull	Matte Black	5-1/16(128) CTC	5-7/16(138)	3/8(10)	1-3/16(30)	3/8 L x 3/8 W (10 L x 10 W)	Aluminum	20 / 200
BP36571G10	\$10.99 (\$12.64)	Pull	Satin Nickel	5-1/16(128) CTC	5-7/16(138)	3/8(10)	1-3/16(30)	3/8 L x 3/8 W (10 L x 10 W)	Aluminum	20 / 200
BP36571ORB	\$10.99 (\$12.64)	Pull	Oil-Rubbed Bronze	5-1/16(128) CTC	5-7/16(138)	3/8(10)	1-3/16(30)	3/8 L x 3/8 W (10 L x 10 W)	Aluminum	20 / 200
BP3657226	\$12.99 (\$14.94)	Pull	Polished Chrome	6-5/16(160) CTC	6-11/16(170)	3/8(10)	1-3/16(30)	3/8 L x 3/8 W (10 L x 10 W)	Aluminum	25 / 250
BP36572FB	\$12.99 (\$14.94)	Pull	Matte Black	6-5/16(160) CTC	6-11/16(170)	3/8(10)	1-3/16(30)	3/8 L x 3/8 W (10 L x 10 W)	Aluminum	25 / 250
BP36572G10	\$12.99 (\$14.94)	Pull	Satin Nickel	6-5/16(160) CTC	6-11/16(170)	3/8(10)	1-3/16(30)	3/8 L x 3/8 W (10 L x 10 W)	Aluminum	25 / 250
BP36572ORB	\$12.99 (\$14.94)	Pull	Oil-Rubbed Bronze	6-5/16(160) CTC	6-11/16(170)	3/8(10)	1-3/16(30)	3/8 L x 3/8 W (10 L x 10 W)	Aluminum	25 / 250
BP3657326	\$6.99 (\$8.04)	Pull	Polished Chrome	3(76) CTC	3-13/16(97)	1(25)	1-5/8(41)	3-3/4 L x 15/16 W (96 L x 24 W)	Aluminum	50 / 500
BP36573FB	\$6.99 (\$8.04)	Pull	Matte Black	3(76) CTC	3-13/16(97)	1(25)	1-5/8(41)	3-3/4 L x 15/16 W (96 L x 24 W)	Aluminum	50 / 500
BP36573G10	\$6.99 (\$8.04)	Pull	Satin Nickel	3(76) CTC	3-13/16(97)	1(25)	1-5/8(41)	3-3/4 L x 15/16 W (96 L x 24 W)	Aluminum	50 / 500
BP36573ORB	\$6.99 (\$8.04)	Pull	Oil-Rubbed Bronze	3(76) CTC	3-13/16(97)	1(25)	1-5/8(41)	3-3/4 L x 15/16 W (96 L x 24 W)	Aluminum	50 / 500
BP3657426	\$8.99 (\$10.34)	Pull	Polished Chrome	3-3/4(96) CTC	4-9/16(116)	1(25)	1-5/8(41)	4-1/2 L x 15/16 W (114 L x 24 W)	Aluminum	50 / 500
BP36574FB	\$8.99 (\$10.34)	Pull	Matte Black	3-3/4(96) CTC	4-9/16(116)	1(25)	1-5/8(41)	4-1/2 L x 15/16 W (114 L x 24 W)	Aluminum	50 / 500
BP36574G10	\$8.99 (\$10.34)	Pull	Satin Nickel	3-3/4(96) CTC	4-9/16(116)	1(25)	1-5/8(41)	4-1/2 L x 15/16 W (114 L x 24 W)	Aluminum	50 / 500
BP36574ORB	\$8.99 (\$10.34)	Pull	Oil-Rubbed Bronze	3-3/4(96) CTC	4-9/16(116)	1(25)	1-5/8(41)	4-1/2 L x 15/16 W (114 L x 24 W)	Aluminum	50 / 500
BP3657526	\$10.99 (\$12.64)	Pull	Polished Chrome	5-1/16(128) CTC	5-13/16(148)	1(25)	1-5/8(41)	5-13/16 L x 15/16 W (148 L x 24 W)	Aluminum	40 / 400
BP36575FB	\$10.99 (\$12.64)	Pull	Matte Black	5-1/16(128) CTC	5-13/16(148)	1(25)	1-5/8(41)	5-13/16 L x 15/16 W (148 L x 24 W)	Aluminum	40 / 400
BP36575G10	\$10.99 (\$12.64)	Pull	Satin Nickel	5-1/16(128) CTC	5-13/16(148)	1(25)	1-5/8(41)	5-13/16 L x 15/16 W (148 L x 24 W)	Aluminum	40 / 400
BP36575ORB	\$10.99 (\$12.64)	Pull	Oil-Rubbed Bronze	5-1/16(128) CTC	5-13/16(148)	1(25)	1-5/8(41)	5-13/16 L x 15/16 W (148 L x 24 W)	Aluminum	40 / 400
BP5300326	\$3.29 (\$3.78)	Pull	Polished Chrome	3-3/4(96) CTC	4-13/16(122)	1/2(13)	1-1/16(27)	13/16 L x 1/2 W (21 L x 13 W)	Zinc	25 / 250
BP53003FB	\$3.29 (\$3.78)	Pull	Matte Black	3-3/4(96) CTC	4-13/16(122)	1/2(13)	1-1/16(27)	13/16 L x 1/2 W (21 L x 13 W)	Zinc	25 / 250
BP53003G10	\$3.29 (\$3.78)	Pull	Satin Nickel	3-3/4(96) CTC	4-13/16(122)	1/2(13)	1-1/16(27)	13/16 L x 1/2 W (21 L x 13 W)	Zinc	25 / 200
BP53003ORB	\$3.29 (\$3.78)	Pull	Oil-Rubbed Bronze	3-3/4(96) CTC	4-13/16(122)	1/2(13)	1-1/16(27)	13/16 L x 1/2 W (21 L x 13 W)	Zinc	25 / 200
BP5300526	\$1.99 (\$2.29)	Knob	Polished Chrome	1-1/4(32) DIA	1-1/4(32)	N/A	1-1/8(29)	5/8(16) DIA	Zinc	25 / 200
BP53005FB	\$1.99 (\$2.29)	Knob	Matte Black	1-1/4(32) DIA	1-1/4(32)	N/A	1-1/8(29)	5/8(16) DIA	Zinc	25 / 200
BP53005G10	\$1.99 (\$2.29)	Knob	Satin Nickel	1-1/4(32) DIA	1-1/4(32)	N/A	1-1/8(29)	5/8(16) DIA	Zinc	25 / 200
BP53005ORB	\$1.99 (\$2.29)	Knob	Oil-Rubbed Bronze	1-1/4(32) DIA	1-1/4(32)	N/A	1-1/8(29)	5/8(16) DIA	Zinc	25 / 200
BP5301226	\$2.59 (\$2.98)	Knob	Polished Chrome	1-1/4(32) DIA	1-1/4(32)	N/A	1-1/16(27)	15/16(24) DIA	Zinc	25 / 200
BP53012FB	\$2.59 (\$2.98)	Knob	Matte Black	1-1/4(32) DIA	1-1/4(32)	N/A	1-1/16(27)	15/16(24) DIA	Zinc	25 / 200
BP53012G10	\$2.59 (\$2.98)	Knob	Satin Nickel	1-1/4(32) DIA	1-1/4(32)	N/A	1-1/16(27)	15/16(24) DIA	Zinc	25 / 200
BP53012ORB	\$2.59 (\$2.98)	Knob	Oil-Rubbed Bronze	1-1/4(32) DIA	1-1/4(32)	N/A	1-1/16(27)	15/16(24) DIA	Zinc	25 / 200
BP5301326	\$2.99 (\$3.44)	Pull	Polished Chrome	3(76) CTC	3-3/8(86)	9/16(14)	1-5/16(33)	5/16(8) DIA	Zinc	25 / 200
BP53013FB	\$2.99 (\$3.44)	Pull	Matte Black	3(76) CTC	3-3/8(86)	9/16(14)	1-5/16(33)	5/16(8) DIA	Zinc	25 / 200
BP53013G10	\$2.99 (\$3.44)	Pull	Satin Nickel	3(76) CTC	3-3/8(86)	9/16(14)	1-5/16(33)	5/16(8) DIA	Zinc	25 / 200
BP53013ORB	\$2.99 (\$3.44)	Pull	Oil-Rubbed Bronze	3(76) CTC	3-3/8(86)	9/16(14)	1-5/16(33)	5/16(8) DIA	Zinc	25 / 200
BP5301426	\$2.99 (\$3.44)	Knob	Polished Chrome	1-3/8(35) LGTH	1-3/8(35)	1(25)	1-3/8(35)	1/2(13) DIA	Zinc	25 / 200
BP53014FB	\$2.99 (\$3.44)	Knob	Matte Black	1-3/8(35) LGTH	1-3/8(35)	1(25)	1-3/8(35)	1/2(13) DIA	Zinc	25 / 200
BP53014G10	\$2.99 (\$3.44)	Knob	Satin Nickel	1-3/8(35) LGTH	1-3/8(35)	1(25)	1-3/8(35)	1/2(13) DIA	Zinc	25 / 200
BP53014ORB	\$2.99 (\$3.44)	Knob	Oil-Rubbed Bronze	1-3/8(35) LGTH	1-3/8(35)	1(25)	1-3/8(35)	1/2(13) DIA	Zinc	25 / 200
BP5524326	\$4.99 (\$5.74)	Pull	Polished Chrome	3-3/4(96) CTC	4-3/16(106)	5/8(16)	1-7/16(37)	7/16(11) DIA	Zinc	25 / 200
BP55243FB	\$4.99 (\$5.74)	Pull	Matte Black	3-3/4(96) CTC	4-3/16(106)	5/8(16)	1-7/16(37)	7/16(11) DIA	Zinc	25 / 200
BP55243G10	\$4.99 (\$5.74)	Pull	Satin Nickel	3-3/4(96) CTC	4-3/16(106)	5/8(16)	1-7/16(37)	7/16(11) DIA	Zinc	25 / 200
BP55243ORB	\$4.99 (\$5.74)	Pull	Oil-Rubbed Bronze	3-3/4(96) CTC	4-3/16(106)	5/8(16)	1-7/16(37)	7/16(11) DIA	Zinc	25 / 200
BP5524426	\$5.99 (\$6.89)	Pull	Polished Chrome	5-1/16(128) CTC	5-9/16(141)	3/4(19)	1-9/16(40)	1/2(13) DIA	Zinc	10 / 80
BP55244FB	\$5.99 (\$6.89)	Pull	Matte Black	5-1/16(128) CTC	5-9/16(141)	3/4(19)	1-9/16(40)	1/2(13) DIA	Zinc	10 / 80
BP55244G10	\$5.99 (\$6.89)	Pull	Satin Nickel	5-1/16(128) CTC	5-9/16(141)	3/4(19)	1-9/16(40)	1/2(13) DIA	Zinc	10 / 80
BP55244ORB	\$5.99 (\$6.89)	Pull	Oil-Rubbed Bronze	5-1/16(128) CTC	5-9/16(141)	3/4(19)	1-9/16(40)	1/2(13) DIA	Zinc	10 / 80
BP5524526	\$8.99 (\$10.34)	Pull	Polished Chrome	6-5/16(160) CTC	6-7/8(175)	7/8(22)	1-3/4(44)	5/8(16) DIA	Zinc	10 / 80
BP55245ORB	\$8.99 (\$10.34)	Pull	Oil-Rubbed Bronze	6-5/16(160) CTC	6-7/8(175)	7/8(22)	1-3/4(44)	5/8(16) DIA	Zinc	10 / 80
BP55245FB	\$8.99 (\$10.34)	Pull	Matte Black	6-5/16(160) CTC	6-7/8(175)	7/8(22)	1-3/4(44)	5/8(16) DIA	Zinc	10 / 80
BP55245G10	\$8.99 (\$10.34)	Pull	Satin Nickel	6-5/16(160) CTC	6-7/8(175)	7/8(22)	1-3/4(44)	5/8(16) DIA	Zinc	10 / 80

Product No.	US Cost (CA Cost)	Product Detail	Dimensions
Allison Merchandising Options • p. 8			
CDB19027	\$210 (\$330)	Amerock Branded Interactive Board 1	21-1/2in W x 18in H
CDB19027NB	\$210 (\$330)	Non-Branded Interactive Board 1	21-1/2in W x 18in H
CDB19020	\$120 (\$215)	Amerock Branded Static Board 1	24in W x 16in H
CDB19020NB	\$120 (\$215)	Non-Branded Static Board 1	24in W x 16in H
CDB19046	\$100 (\$160)	Tray (product assortment sold separately)	18in L x 14in W x 2-1/4in D
CDB19047	\$55 (\$100)	Tray Lid (optional)	-
CDB19042	\$95 (\$155)	Board 1 Product Assortment for Tray	-
Additional Display Option			
CDB19052	\$200 (\$295)	Floating Wall Display (holds 3 boards)	30in W x 64-1/2in H

Prices subject to change, and effective 10/1/19. Mounting hardware included.
 The dimensional information provided here should be verified with the actual product prior to drilling or attempting to install the hardware.
 Please direct any questions you may have on the installation process to Amerock Customer Service (see back cover for contact information).



Amerock is Embedded in
2020's General Hardware
Library (*Versions 11.9 & Up*)
and in Envision Software.



EST. 1928

CONTACT US

CUSTOMER SERVICE

10115 Kinsey Ave, Suite 210
Huntersville, NC 28078

amerock.customersupport@amerock.com

P: 1-800-435-6959

F: 1-800-618-6733

Amerock.com



©2019