



sheet metal

quality since 1946

product catalog

(800) 699 - 2253

www.ablemetal.com



Southern California Location:
614 N. Ford Blvd.
Los Angeles, CA 90022-1107

(800) 699-ABLE

www.ablemetal.com

Northern California Location:
14111 Catalina St.
San Leandro, CA 94577-5540

EDGING & FLASHING

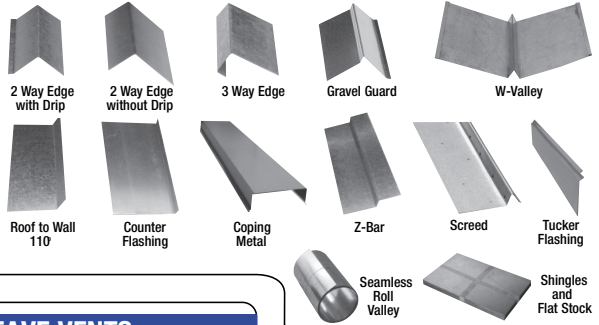

RAIN CARRYING PRODUCTS

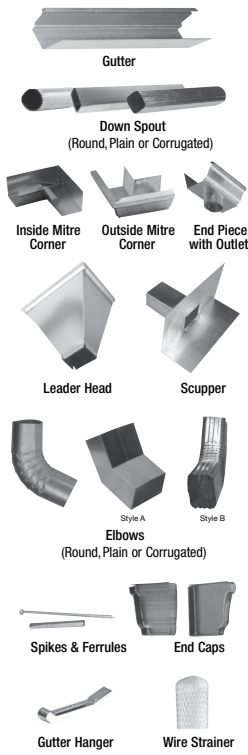

FOUNDATION & EAVE VENTS

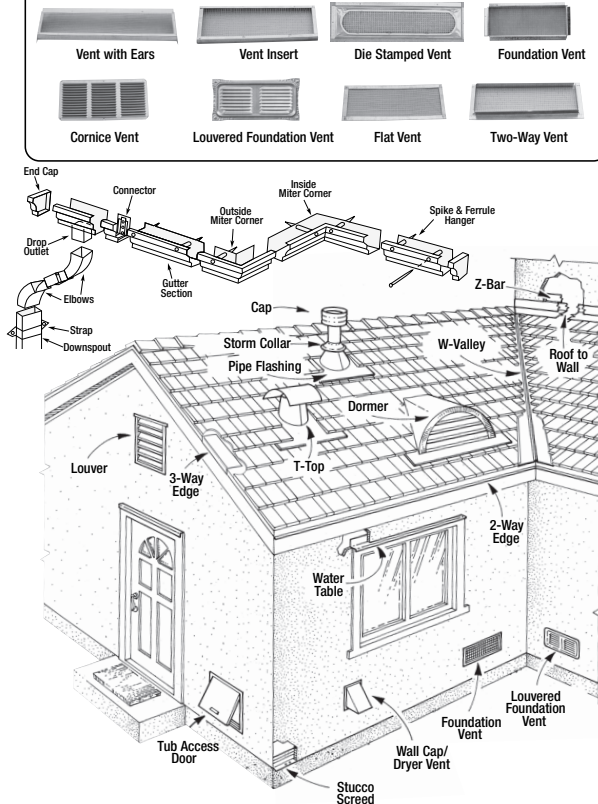

ACCESS DOORS



HOODS, VENTS & LOUVERS

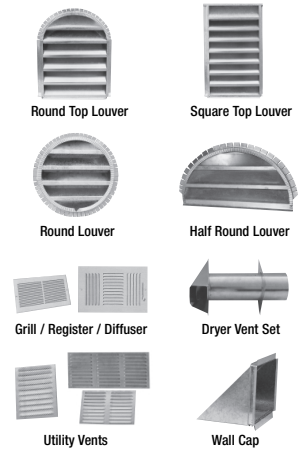

HVAC

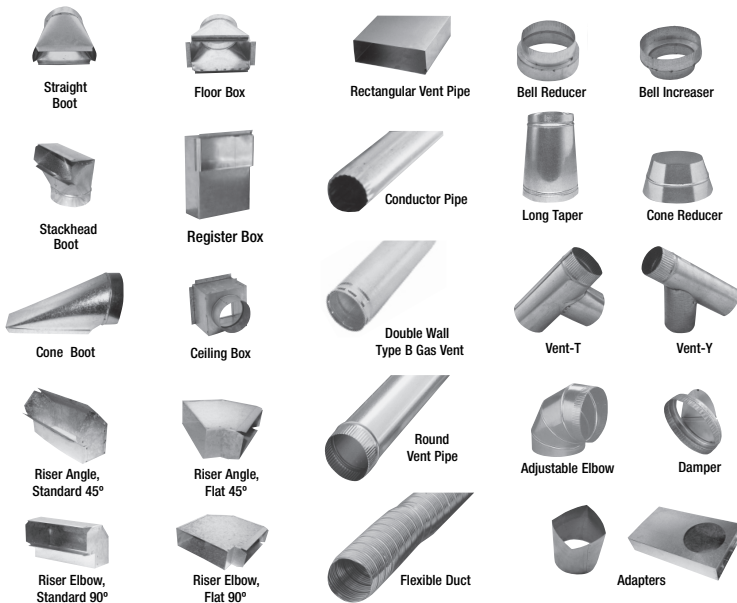

ROOF VENTS, CAPS & JACKS

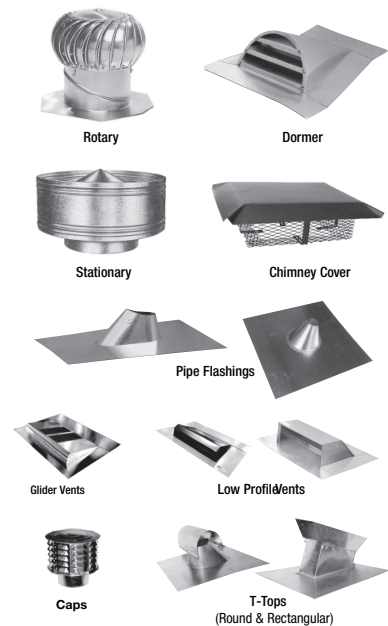

Custom Fabricating to Your Specifications ▲ **Materials Available: Galvanized, Zinalume, Bonderized, Painted and Copper**

Edging / Flashing

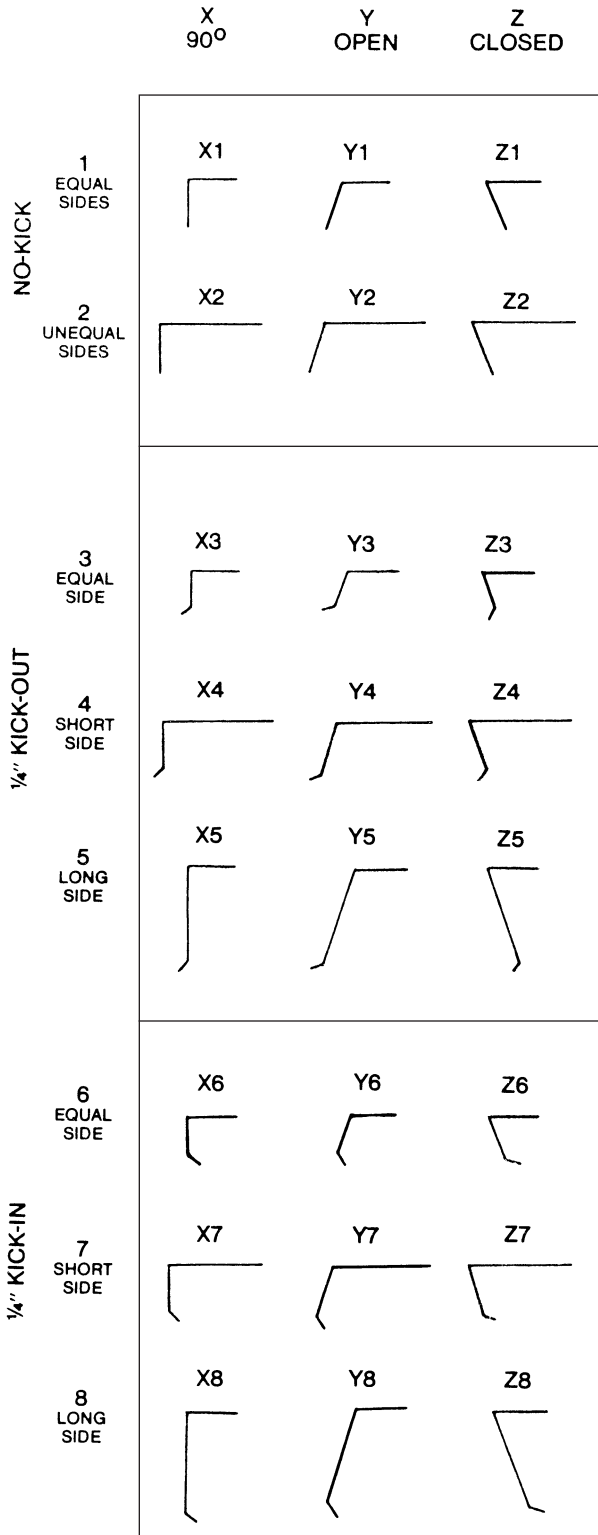

Item	Description
10000	2 Way Edging - Per Specifications
10100	1x1 Galv
10200	1x1 Bond
10300	1x1 Painted
10400	1x2 Galv
10500	1x2 Bond
10600	1x2 Painted
10700	1 1/2x1 1/2 Galv
10800	1 1/2x1 1/2 Bond
10900	1 1/2x1 1/2 Painted
11000	1 1/2x2 Galv
11100	1 1/2x2 Bond
11200	1 1/2x2 Painted
11300	2x2 Galv
11400	2x2 Bond
11500	2x2 Painted
11600	2x3 Galv
11700	2x3 Bond
11800	2x3 Painted
11900	2x4 Galv
12000	2x4 Bond
12100	2x4 Painted
12200	3x3 Galv
12300	3x3 Bond
12400	3x3 Painted
12500	3x4 Galv
12600	3x4 Bond
12700	3x5 Galv
12800	3x5 Bond
12900	4x4 Galv
13000	4x4 Bond
13100	4x5 Galv
13200	4x5 Bond
13300	4x6 Galv
13400	4x6 Bond
13500	5x5 Galv
13600	5x5 Bond
13900	6x6 Galv
14000	6x6 Bond
14100	1/2x4 Galv
14200	1/2x5 Galv
14300	1/2x6 Galv
	<p>ITEMS ARE AVAILABLE:</p> <ul style="list-style-type: none"> ✓ PAINTED WHITE, BROWN, OR CHARCOAL; ✓ GALVANIZED, ZINCALUME, BONDERIZED, OR COPPER; ✓ IN SPECIFIED GAUGES.

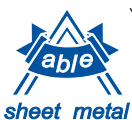

Phone (800) 699-2253

Edging / Flashing / Trim

Item	Description
15000	3 Way Edging - Per Specifications
15600	Tile Pan - Per Specifications
15620	Tile Riser - L Style - Per Specifications
15600	Tile Riser - T Style - Per Specifications
15650	Channel - Per Specifications
15700	Z Bar - Per Specifications
15800	Z Bar - 1x ³ / ₈ x1 Galv
15900	Z Bar - 1x ³ / ₈ x1 Bond
16000	Z Bar - 1x ¹ / ₂ x1 Galv
16100	Z Bar - 1x ¹ / ₂ x1 Bond
16200	Z Bar - 1x ⁵ / ₈ x1 Galv
16300	Z Bar - 1x ⁵ / ₈ x1 Bond
16400	Z Bar - 2x1x2 Galv
16500	Z Bar - 2x1x2 Bond
16600	Z Bar - 2x1x3 Galv
16650	Z Bar - 2x1x3 Bond
17000	Water Table
17500	Diato - Per Specifications
17600	Deck Flashing - Per Specifications
17700	Coping - Per Specifications
17800	Tucker Flashing - Per Specifications
18000	Chimney Saddle - Per Specifications
18100	Chimney Stock - Per Specifications
18200	Misc. Flashing - Per Specifications

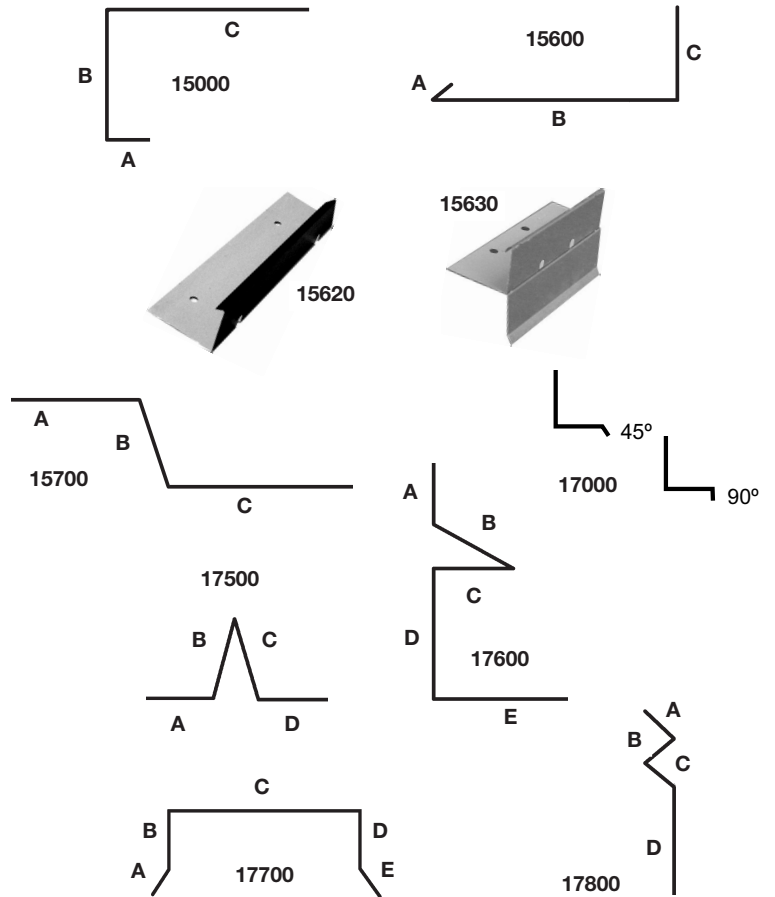

Accessories for Drywall / Lath

Item	Description
16750	J-Metal
16800	Casing Bead
16850	Corner Bead, Drywall, Regular
16860	Corner Bead, Drywall, Bullnose
16880	Corner Bead, Lath
16900	Cornerite
17400	Screed 5 ¹ / ₂ " perforated Galv

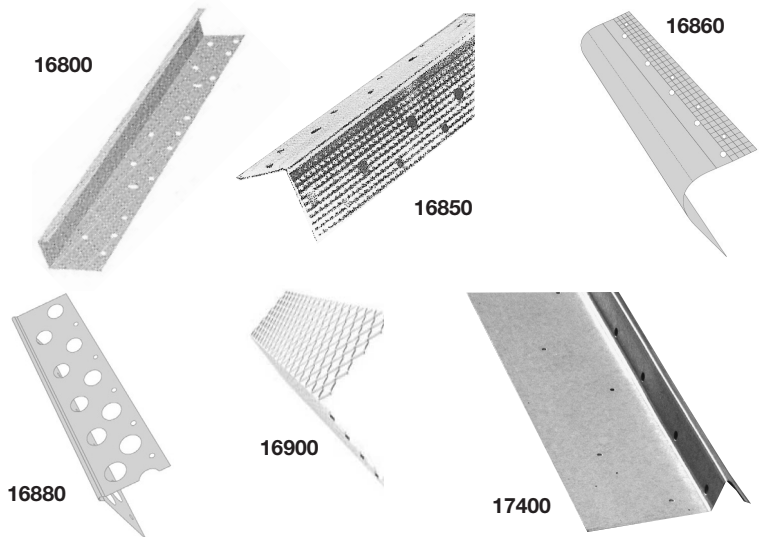

Pitch Pans / Pockets

Item	Description
19700	Pitch Pans / Pockets - Per Specifications
	✓ SPECIFY OPEN OR CLOSED.

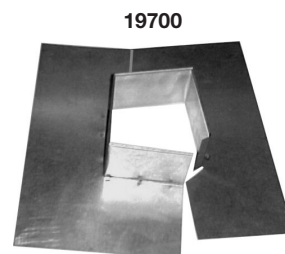

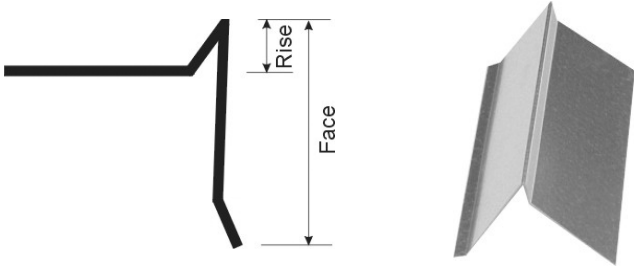

Gravel Guard

Item	Description
20000	4" Galv
20400	4" Painted
20500	6" Galv
20800	6" Painted
	<ul style="list-style-type: none"> ✓ SPECIFY RISE. ✓ SPECIFY FACE.

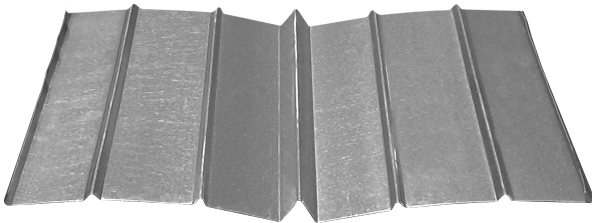
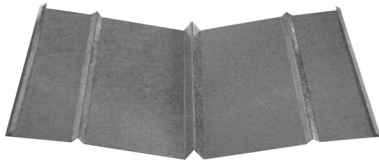
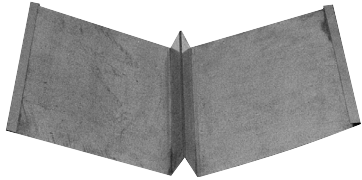

W-Valley

Item	Description
21500	18" Galv
21800	18" Painted
22000	24" Galv
22200	24" Painted
2200-3R	24" Galv, 3-Rib
2200-5R	24" Galv, 5-Rib
2235-5R	30" Galv, 5-Rib
	<ul style="list-style-type: none"> ✓ SPECIFY HEM, CROWN OR RIB.



Roll Valley

Item	Description
23300	8"x50' Galv or Painted
23400	14"x50' Galv or Painted
23500	20"x50' Galv or Painted
23700	8"x50' Aluminum
23800	14"x50' Aluminum
23900	20"x50' Aluminum
	<ul style="list-style-type: none"> ✓ ITEMS ARE AVAILABLE IN OTHER LENGTHS AND MATERIALS.

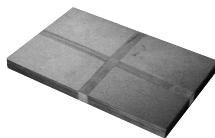

Flat Stock / Shingles / Step Shingles

Item	Description
24200	Shingles, 5x7 Galv or Painted
24300	Shingles, 8x12 Galv or Painted
24350	Shingles, 6x8 Galv or Painted
18150	Step Shingles, 3x5x8 Galv or Painted
24500	Flat Stock - Per Specifications
	<ul style="list-style-type: none"> ✓ ITEMS ARE AVAILABLE IN OTHER LENGTHS AND MATERIALS.

Gutter

Item	Description
25000	K4 10" girth Galv
25250	K4 10" girth Bond
25300	K4 10" girth Painted
25400	K5 12" girth Galv
25600	K5 12" girth Bond
25700	K5 12" girth Painted
✓ ITEMS ARE AVAILABLE IN 10' OR 20' LENGTHS.	

Gutter Fittings

Item	Description
25800	K4 Outside Corner Mitre
25900	K5 Outside Corner Mitre
26000	K4 Inside Corner Mitre
26100	K5 Inside Corner Mitre
26200	K4 Slip Connector
26300	K5 Slip Connector
26400	K4 End Piece w/Oval Drop Outlet
26500	K5 End Piece w/Oval Drop Outlet
26620	K4 End Cap Tap-On, Left
26630	K4 End Cap Tap-On, Right
26720	K5 End Cap Tap-On, Left
26730	K5 End Cap Tap-On, Right
27000	Oval Drop Outlet
27100	Outlet Strainer
27150	Gutter Guard, Hinged
27200	7" Spikes
27300	7" Spikes (Box)
27400	8" Spikes
27500	8" Spikes (Box)
27600	4" Ferrules
27610	4" Ferrules (Box)
27700	5" Ferrules
27710	5" Ferrules (Box)
27800	K4 Strap Hanger
27900	K5 Strap Hanger

✓ ITEMS ARE AVAILABLE: ✓ PAINTED WHITE, BROWN, OR CHARCOAL; ✓ GALVANIZED, ZINCALUME, BONDERIZED, ALUMINUM, OR COPPER; ✓ IN SPECIFIED GAUGES.

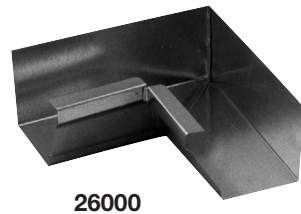
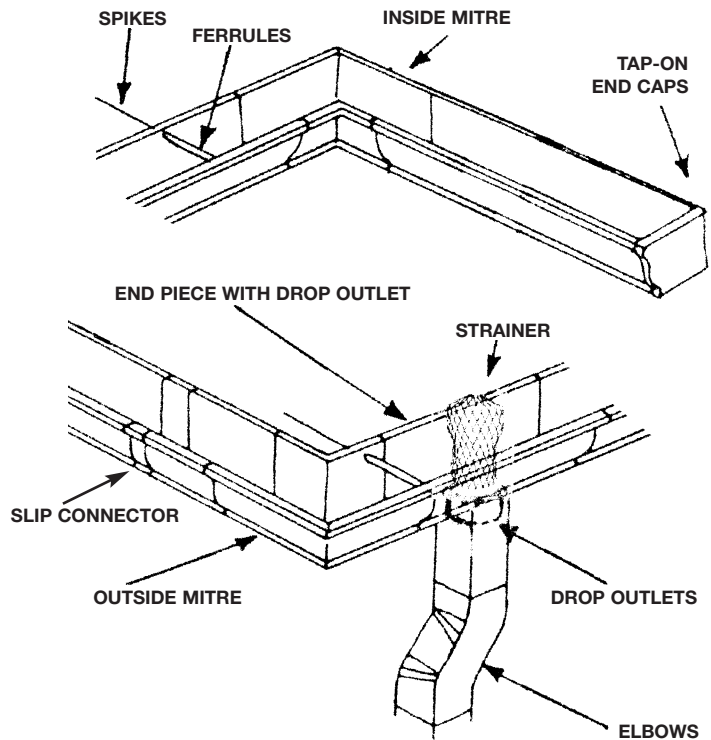

26000

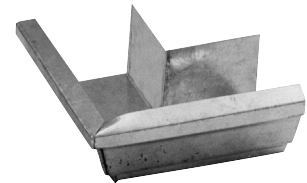

25800

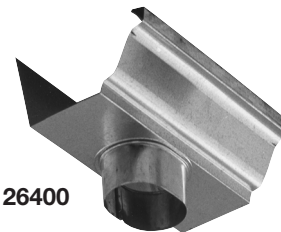

26400



27000

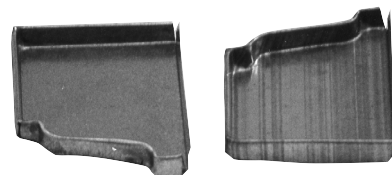

26600

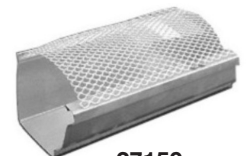

27150

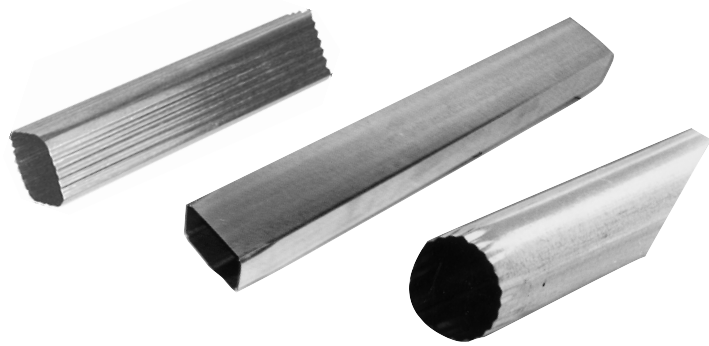

Downspout / Conductor Pipe

Item	Description
30000	2x3 Corrugated Galv
30300	2x3 Plain Galv
30600	3x4 Plain Galv
31000	4x6 Plain Galv
29000	Downspout Bandalles / Straps
32100	3" Plain Round Galv
32200	3" Plain Round Bond
32400	4" Plain Round Galv
32500	4" Plain Round Bond

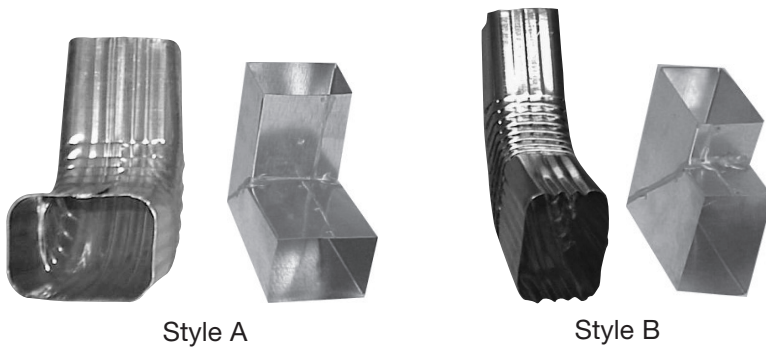

Elbows, Solid

Item	Description
33000	2x3 Corr. Style A, 45°, 60°, 75°, 90°
33050	2x3 Corr. Style B, 45°, 60°, 75°, 90°
33100	2x3 Corr. 12" long stem, 75°
33150	2x3 Plain, Style A, 45°, 60°, 75°, 90°
33200	2x3 Plain, Style B, 45°, 60°, 75°, 90°
33250	3x4 Plain, Style A, 45°, 75°, 90°
33300	3x4 Plain, Style B, 45°, 75°, 90°
33350	4x6 Plain, Style A, 45°, 90°
33400	4x6 Plain, Style B, 45°, 90°
33450	3" Plain Round Galv, 45°, 75°, 90°
33500	4" Plain Round Galv, 45°, 75°, 90°

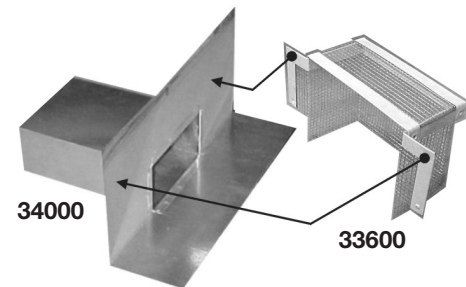
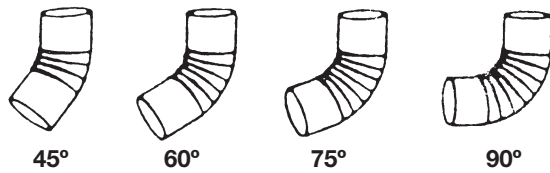

Scuppers (Outlets) / Leader Heads

Item	Description
34000	Roof Outlet 2x3 Center, Left, or Right
34100	Roof Outlet 3x4 Center, Left, or Right
34200	Roof Outlet 4x6 Center, Left, or Right
34300	Leader Head 2x3 Galv
34400	Leader Head 3x4 Galv
34500	Leader Head 4x6 Galv
33600	Able Universal Scupper Guard: 4x8x6
✓ CUSTOM SIZES AND DESIGNS PER SPECIFICATIONS.	

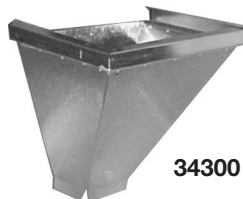
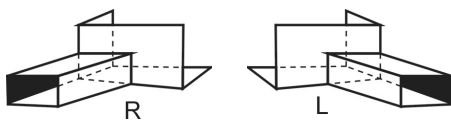

ITEMS ARE AVAILABLE:	
✓	PAINTED WHITE, BROWN, OR CHARCOAL;
✓	GALVANIZED, ZINCALUME, BONDERIZED, ALUMINUM, OR COPPER;
✓	IN SPECIFIED GAUGES.

Bird-Stop

Item	Description
34900	Barcelona
35000	Capistrano
35000	Malibu
36000	Espana
36000	Villa
	✓ ITEMS ARE AVAILABLE: PAINTED RED OR BLACK; IN OTHER POPULAR MFR. STYLES.

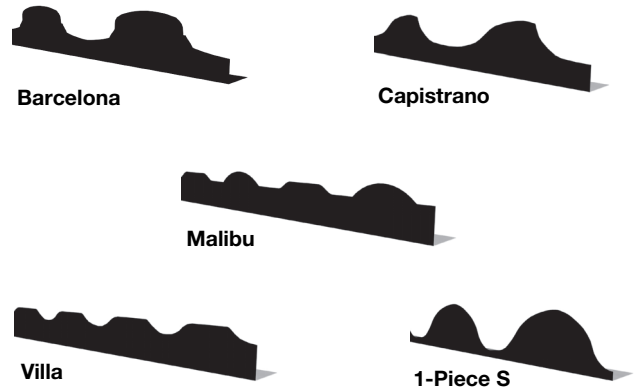

Siding Corners

Item	Description
40050	4" Galv
40150	6" Galv
40250	8" Galv
40350	10" Galv
40450	12" Galv

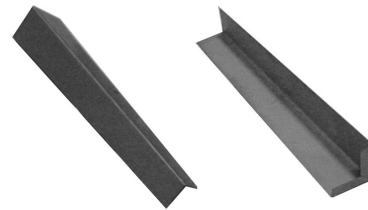

Attic Access Doors

Item	Description
41000	20x20 Galv
41200	22x22 Galv
41400	22x30 Galv
41600	30x30 Galv

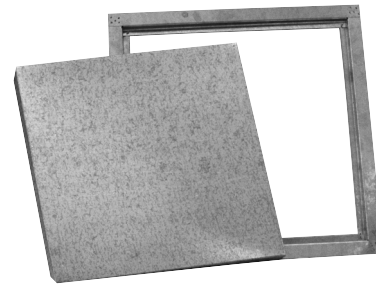

Tub Access Doors

Item	Description
42000	14x14 Lift-Out w/ P.G., Galv
42200	14x14 Snap-In 1/2" P.G., Galv
42350	14x14 Snap-In 5/8" P.G., Galv
42400	14x14 Snap-In 3/4" P.G., Galv
42370	14x14 Snap-In 7/8" P.G., Galv
42600	14x14 Hinged 1/2" P.G., Galv
42700	14x14 Hinged 5/8" P.G., Galv
42800	14x14 Hinged 3/4" P.G., Galv
42950	14x14 Hinged 7/8" P.G., Galv



Crawl Hole Doors

Item	Description
43500	24x18 Galv, Door and Frame
43700	24x18 Galv, Door or Frame
43900	24x24 Galv, Door and Frame
44100	24x24 Galv, Door or Frame

✓ ITEMS ARE AVAILABLE IN OTHER SIZES
PER SPECIFICATIONS.



Phone (800) 699-2253

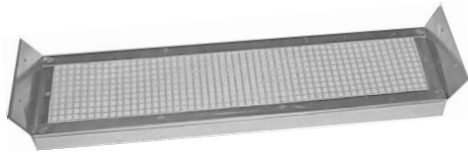

VENT WITH EARS OUT



VENT WITH EARS IN

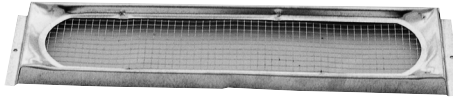

45200

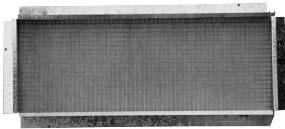

47800

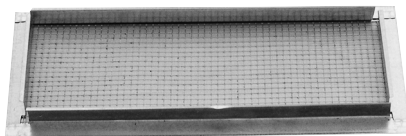

48000

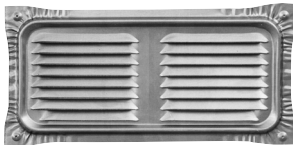

48200

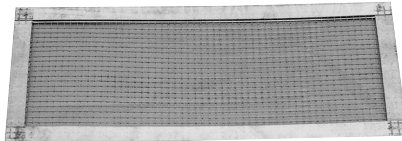

48600

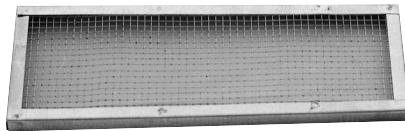

48800

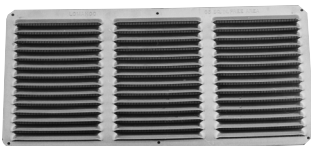

52700

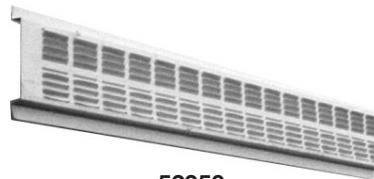

52950

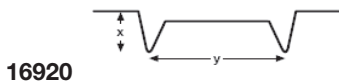

16920

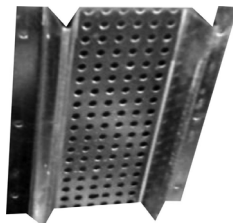

Eave Vents

Item	Description
45000	14x3 for Stucco Galv
45110	14x3 Two-Way Galv
45200	14x3 Die Stamped Galv
45400	14x3 Flat for Siding Galv
45600	14x3 Inserts Galv
45800	14x3 P.G. Four Sides Galv
46000	14x3 w/Ears Galv
46200	22x3 for Stucco Galv
46310	22x3 Two-Way Galv
46400	22x3 Die Stamped Galv
47000	22x3 P.G. Four Sides Galv
47200	22x3 w/Ears Galv

Foundation Vents

Item	Description
47400	22x6 for Stucco Galv
47510	22x6 Two-Way Galv
47600	22x6 w/Ears Galv
47800	14x6 for Stucco Galv
48000	14x6 Two-Way Galv
48200	14x6 Louvered Galv
48400	14x6 Louvered w/Mesh Galv
48600	14x6 Flat for Siding Galv
48800	14x6 Inserts Galv
49000	14x6 w/Ears Galv
49150	14x6 Floral Cover, White Plastic

Cornice / Soffit Vents

Item	Description
52700	16x4 Cornice, Louvered, 1/8" Mesh
52800	16x6 Cornice, Louvered, 1/8" Mesh
52900	16x8 Cornice, Louvered, 1/8" Mesh
52930	2 ³ / ₈ " x 8' long Continuous Soffit
52950	2 ³ / ₄ " x 8' long Continuous Soffit
52970	3 ³ / ₄ " x 8' long Continuous Soffit
16920	Reveal Screed - Continuous Soffit Galv, 10' long, with 1/8" Holes
	✓ AVAILABLE IN MILL FINISH ALUMINUM, OR PAINTED WHITE OR BROWN.

Wall Caps / Side Hoods / Door Hoods

Item	Description
50000	4x4 Galv
50200	7x7 Galv
50400	10x3 1/2 Galv
51000	Wall Caps / Side Hoods - Per Specifications
51200	Door Hoods - Per Specifications

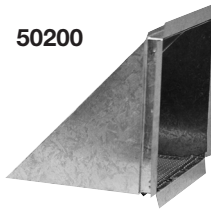

50200

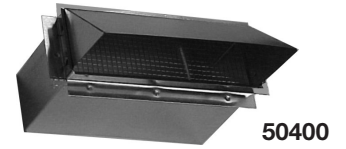

50400

Dryer Vents / Air Vents

Item	Description
51500	3" Alum Hood, w/Duct
51600	4" Alum Hood, w/Duct
51700	4" Galv Hood w/P.G., Duct
	✓ SPECIFY WITH DAMPER OR MESH.

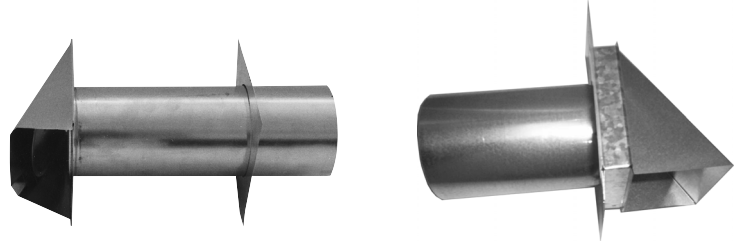

Utility Vents

Item	Description
52000	6x4 Utility, Louvered
52100	6x8 Utility, Louvered
52200	8x8 Utility, Louvered
52300	12x8 Utility, Louvered
52400	18x8 Utility, Louvered
52500	12x12 Utility, Louvered
52600	14x14 Utility, Louvered
	✓ AVAILABLE GALV OR ALUMINUM.

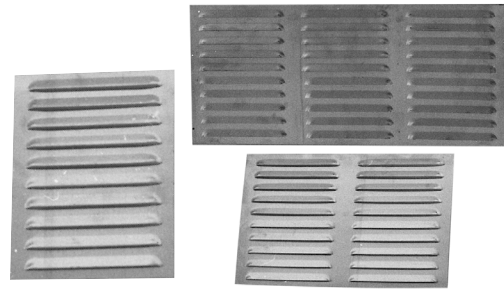

Grilles / Registers / Diffusers

Item	Description
49750	Grilles - Per Specifications
49850	Registers - Per Specifications
49950	Diffusers - Per Specifications

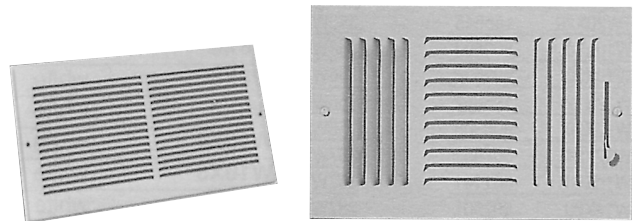

Square-Top Louvers

Item	Description
53000	14x9 Galv
53200	14x12 Galv
53400	14x18 Galv
53600	14x24 Galv
53800	14x30 Galv
54050	18x18 Galv
54100	18x24 Galv
54150	24x24 Galv



	<p>ITEMS ARE AVAILABLE:</p> <ul style="list-style-type: none"> ✓ GALVANIZED, ZINCALUME, BONDERIZED, OR COPPER; ✓ IN OTHER SIZES PER SPECIFICATIONS.
--	---

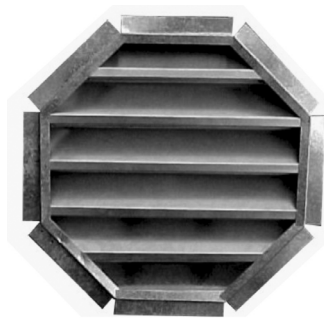
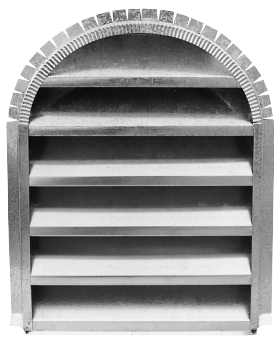

Special Louvers

Item	Description
54400	Round-Top - Per Specifications
54500	Arch-Top - Per Specifications
54550	Oval - Per Specifications
54800	Triangle-Top (Peak-Top) - Per Specifications
54900	Triangle - Per Specifications
54960	Hexagon - Per Specifications
54980	Octagon - Per Specifications

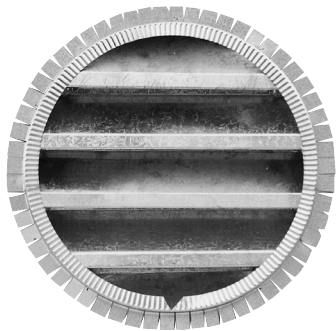

Round Louvers

Item	Description
55000	12" Galv
55200	14" Galv
55400	16" Galv
55600	18" Galv
55800	20" Galv
56000	24" Galv
56200	30" Galv
56500	1" Aluminum
56520	2" Aluminum
56540	3" Aluminum
56560	4" Aluminum

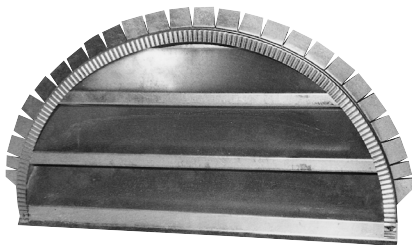

Half-Round Louvers

Item	Description
56700	12" Galv
56800	14" Galv
56900	16" Galv
57000	18" Galv
57100	20" Galv
57200	24" Galv
57400	30" Galv

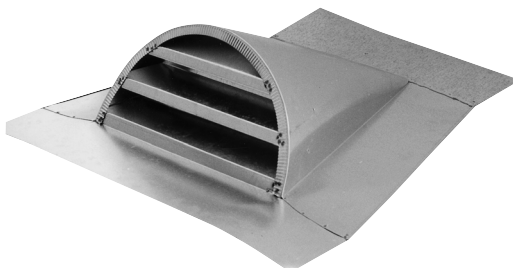

Dormer Roof Vents

Item	Description
58000	18x9 Zincalume
58200	18x9 for Shake
58400	18x9 w/Soft Alum Base
58600	18x9 Sub Base
58700	24x12 Zincalume
58900	24x12 for Shake
59100	24x12 w/Soft Alum Base
59300	24x12 Sub Base

<p>ITEMS ARE AVAILABLE:</p> <ul style="list-style-type: none"> ✓ GALVANIZED, ZINCALUME, BONDERIZED, OR COPPER; ✓ IN OTHER SIZES PER SPECIFICATIONS.

GLIDER VENT

The new Low-Profile Glider* Vent provides an impressive 73 sq. inch NFA (with 1/4" mesh) and blends well with various roofing materials. Our vent is designed for use on composition shingle, flat tile, shake or slate roof applications and offers modern style with an efficient solution for attic area ventilation. (*Patent No. US 9,447,583 B2)

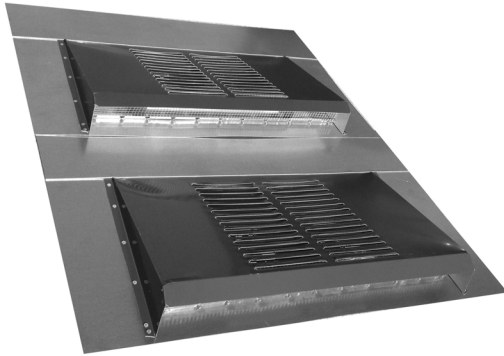

PRODUCT NAME	A	B	C	D	E	F	G	H	HARDWARE MESH	APPROX NFA
SHINGLE BASE, REG/LARGE	22	4/6	30/34	5	5.75	13	6	2.5	1/4"	73
SHAKE BASE, REG/LARGE	22	4/6	30/34	5	5.75	13	12	2.5	1/4"	73
EMBER RESISTANT (ER), R/L	22	4/6	30/34	5	5.75	13	6/12	2.5	1/8"	70

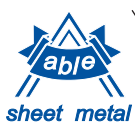
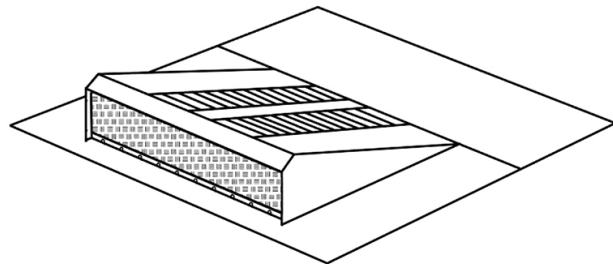
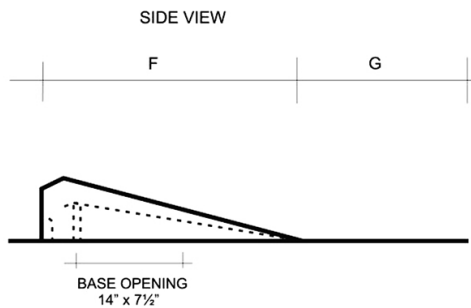
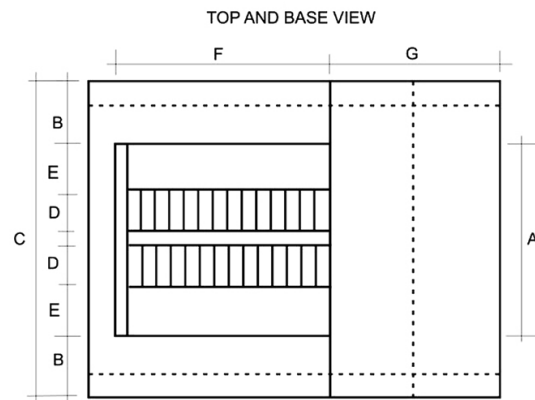
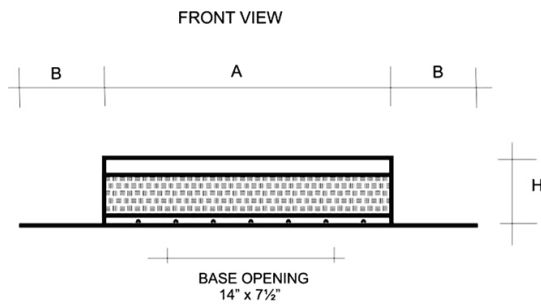

Phone (800) 699-2253

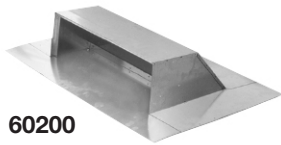

60200

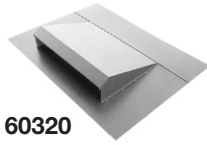

60320

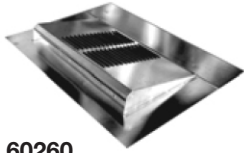

60260

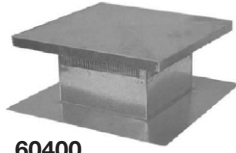

60400

Roof Vents, Square / Rectangular

Item	Description
60200	20x6 Galv Low Profile Rectangular
60260	22x2.5 Galv Low Profile Glider Vent
60320	18x4 Galv Low Profile Eyebrow Vent
60400	Gravity / Economy / Square - Per Spec's
	✓ AVAILABLE WITH REGULAR OR SHAKE BASE AND OTHER MATERIALS.

Roof Vent Assemblies



Item	Description
60930	3" .025 Aluminum, Regular Base
60940	4" .025 Aluminum, Regular Base
60950	5" .025 Aluminum, Regular Base
60960	6" .025 Aluminum, Regular Base
60970	7" .025 Aluminum, Regular Base
60980	8" .025 Aluminum, Regular Base
60900	4" .025 Aluminum, Oval, Regular Base
	✓ UL LISTED. AVAILABLE WITH SHAKE BASE AND IN OTHER SIZES.

Roof Jack T-Tops, Round

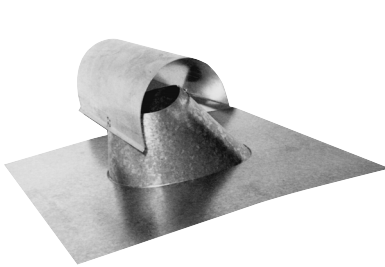

Item	Description
62000	3" Galv
62200	4" Galv
62400	5" Galv
62600	6" Galv
62800	7" Galv
63800	Per Specifications
	✓ AVAILABLE WITH END CAPS, WIRE MESH, SHAKE BASE, OTHER SIZES AND MATERIALS.

Roof Jacks / Roof Safes

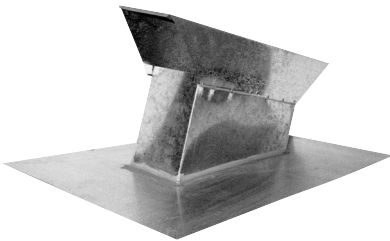

Item	Description
64000	6x6 Galv
64200	4x11 Galv, Parallel to Ridge
64400	4x11 Galv, 90° to Ridge
64600	4x11 Galv, Flat Type
64800	Roof Safes, Galv
	✓ ITEMS ARE AVAILABLE IN OTHER SIZES PER SPECIFICATIONS.

Chimney Covers (Adjustable)

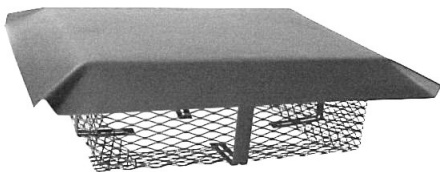

Item	Description
99630-S	8x8, 9x9, 8x12, 9x13, 12x12, 13x13, 8" Round, 10" Round, 12" Round
99630-L	13x13, 13x18, 9x18, 12x16, 8x17 Oval, 10x17 Oval, 13x17 Oval

Stationary Ventilators

Item	Description
65000	8" Galv
65100	10" Galv
65200	12" Galv
65300	14" Galv
65400	16" Galv
65500	18" Galv
65600	20" Galv



Rotary Ventilators

Item	Description
66500	8" Galv
66550	8" Galv, with Base
66600	10" Galv
66650	10" Galv, with Base
66700	12" Galv
66750	12" Galv, with Base
66760	12" Aluminum, Internally Braced
66770	12" Aluminum, Internally Braced, with Base
66780	12" Aluminum, Externally Braced
66790	12" Aluminum, Externally Braced, with Base
66800	14" Galv
66850	14" Galv, with Base
66860	14" Aluminum, Internally Braced
66870	14" Aluminum, Internally Braced, with Base
66880	14" Aluminum, Externally Braced
66890	14" Aluminum, Externally Braced, with Base
66900	16" Galv
66950	16" Galv, with Base
67000	18" Galv
67050	18" Galv, with Base
67100	20" Galv
67150	20" Galv, with Base



Ventilator Bases

Item	Description
68000	8" Galv
68100	10" Galv
68200	12" Galv
68300	14" Galv
68400	16" Galv
68500	18" Galv
68600	20" Galv

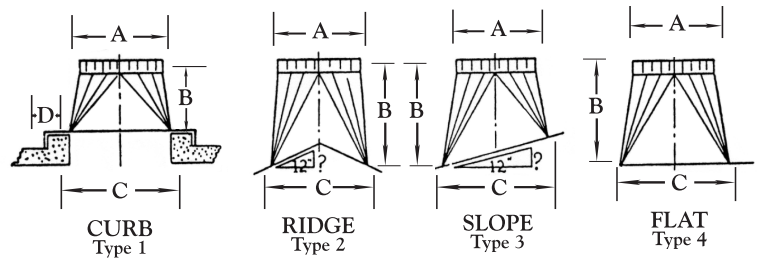
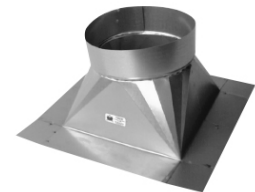

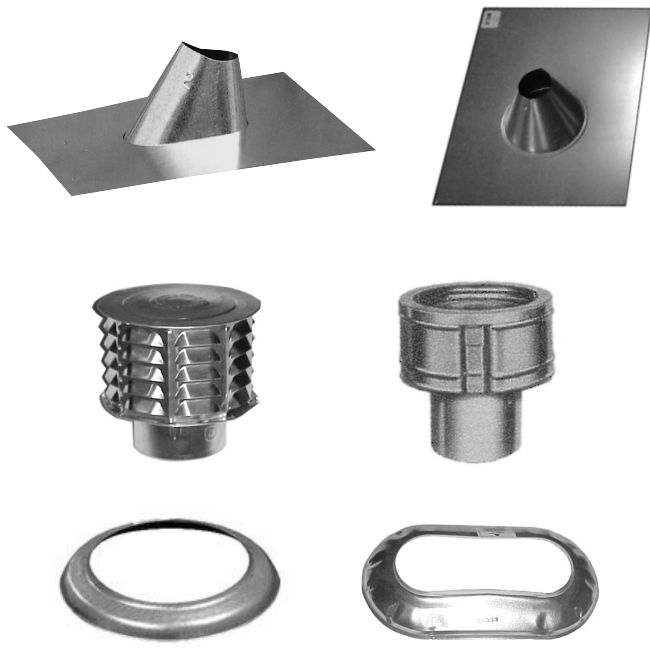

Pipe Flashings / Caps / Collars

Item	Description
61000	1/2" Std or FHA; Reg, Shingle or Shake
61050	1" Std or FHA; Reg, Shingle or Shake
61100	1 1/2" Std or FHA; Reg, Shingle or Shake
61150	2" Std or FHA; Reg, Shingle or Shake
61200	3" Std or FHA; Reg, Shingle or Shake
61250	4" Std or FHA; Reg, Shingle or Shake
61300	5" Std or FHA; Reg, Shingle or Shake
61350	6" Std or FHA; Reg, Shingle or Shake
61400	7" Std or FHA; Reg, Shingle or Shake
61450	8" Std or FHA; Reg, Shingle or Shake
61600	Pipe Caps, All Sizes, Universal (CW) or Double-Wall (ECW)
61900	Pipe Collars, All Sizes
	<ul style="list-style-type: none"> ✓ GALVANIZED, ALUMINUM, OR COPPER; ✓ IN OTHER SIZES AND PITCHES PER SPECIFICATIONS.

Single-Wall, Round Vent Pipe

Item	Description
70000	3x30" long, Galv, ASM
70100	4x36" long, Galv, KD
70200	4x30" long, Galv, ASM
70300	5x36" long, Galv, KD
70400	5x30" long, Galv, ASM
70500	6x36" long, Galv, KD
70600	6x30" long, Galv, ASM
70700	7x36" long, Galv, KD
70800	7x30" long, Galv, ASM
70900	8x36" long, Galv, KD
71000	8x30" long, Galv, ASM



Double-Wall, Type B, Gas Vent

Item	Description
72000	Type B Gas Vent Pipe
72400	Type B Gas Vent Flashings
72800	Type B Gas Vent Fittings

Duct, Flexible Aluminum

Item	Description
73050	3" Bare Alum, 8' compressed to 30"
73150	4" Bare Alum, 8' compressed to 30"
73250	5" Bare Alum, 8' compressed to 30"
73350	6" Bare Alum, 8' compressed to 30"
73450	7" Bare Alum, 8' compressed to 30"
73550	8" Bare Alum, 8' compressed to 30"

Elbows, Adjustable 90°

Item	Description
75000	3" Galv
75100	4" Galv
75200	5" Galv
75300	6" Galv
75400	7" Galv
75500	8" Galv
75600	9" Galv
75700	10" Galv
75800	12" Galv
75900	14" Galv
76000	16" Galv



Vent T's

Item	Description
77000	3" Galv
77100	4" Galv
77200	5" Galv
77300	6" Galv
77400	7" Galv
77500	8" Galv

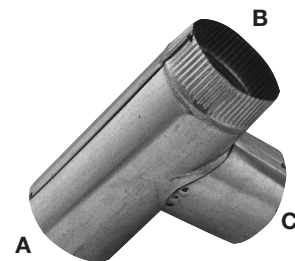

Vent Y's

Item	Description
78000	3" Galv
78100	4" Galv
78200	5" Galv
78300	6" Galv
78400	7" Galv
78500	8" Galv

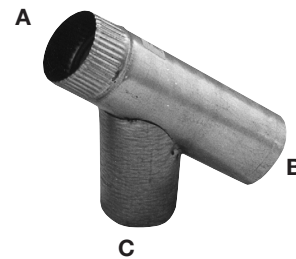

Adapters

Item	Description
79000	3 1/4x10 to 6x6 Sq.
79100	3 1/4x10x18 w/7" Hole, w/Cap
79200	6x6 Sq. to 7" Round

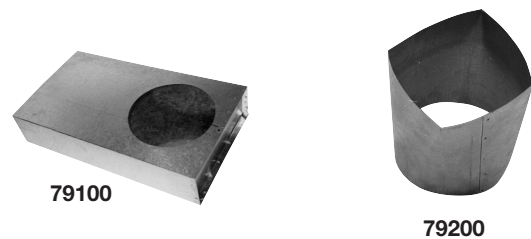

HVAC Caps / Pans

Item	Description
79500	Caps - Per Specifications
79750	Pans - Per Specifications

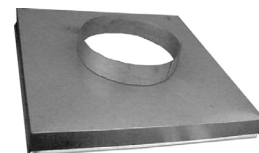



80000



81000

Bell-Type Reducers / Increasers

Item	Description
8000	Bell-Type Reducers - Per Specifications
8100	Bell-Type Increasers - Per Specifications

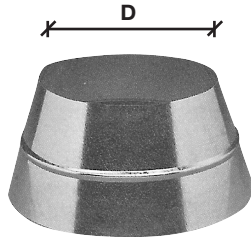

Cone-Type Reducers

Item	Description
8200	6xDx6" long, Galv
8210	7xDx6" long, Galv
8220	8xDx6" long, Galv
8230	9xDx6" long, Galv
8240	10xDx6" long, Galv
8250	12xDx6" long, Galv

Tapers

Item	Description
8290	5xDx9" long, Galv
8300	6xDx9" long, Galv
8310	7xDx9" long, Galv
8320	8xDx9" long, Galv
8330	9xDx9" long, Galv
8340	10xDx9" long, Galv
8350	12xDx9" long, Galv
8370	10xDx12" long, Galv
8380	12xDx12" long, Galv

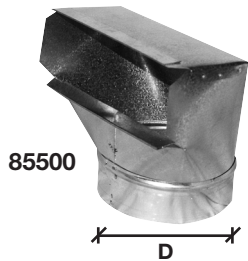

85500

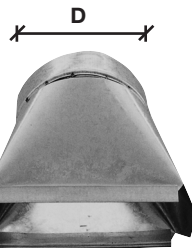

85000

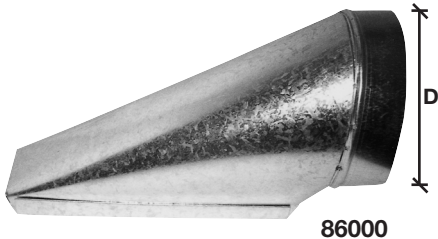

86000

Boots: Straight, Stackhead, Cone

Item	Description
8500	3 1/4x8xD Galv Straight Boots
8510	3 1/4x10xD Galv Straight Boots
8520	3 1/4x12xD Galv Straight Boots
8550	3 1/4x8xD Galv Stackhead Boots
8560	3 1/4x10xD Galv Stackhead Boots
8570	3 1/4x12xD Galv Stackhead Boots
8600	3 1/4x8xD Galv Cone Boots
8610	3 1/4x10xD Galv Cone Boots
8620	3 1/4x12xD Galv Cone Boots

Boxes: Floor, Register, Ceiling

Item	Description
90000	Floor Box, 8x6xD Galv, with P.G.
90200	Floor Box, 10x6xD Galv, with P.G.
90400	Floor Box, 12x6xD Galv, with P.G.
91000	Register Box, 3 ¹ / ₄ x8xC Galv, with P.G.
91200	Register Box, 3 ¹ / ₄ x10xC Galv, with P.G.
91400	Register Box, 3 ¹ / ₄ x12xC Galv, with P.G.
92200	Ceiling Box, 8x8xD Galv
92400	Ceiling Box, 10x10xD Galv
92600	Ceiling Box, 12x12xD Galv

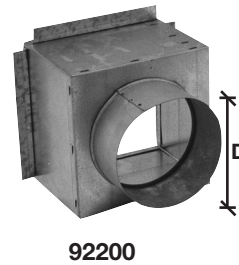
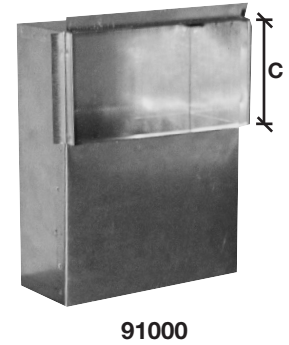
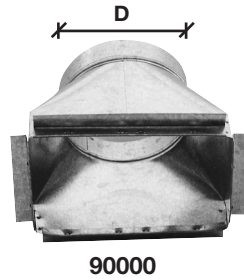

Rectangular (Riser) Vent Pipe

Item	Description
95000	3 ¹ / ₄ x8x30" long, Galv, KD
95100	3 ¹ / ₄ x8x30" long, Galv, ASM
95200	3 ¹ / ₄ x10x30" long, Galv, KD
95300	3 ¹ / ₄ x10x30" long, Galv, ASM
95400	3 ¹ / ₄ x12x30" long, Galv, KD
95500	3 ¹ / ₄ x12x30" long, Galv, ASM
95600	3 ¹ / ₄ x14x30" long, Galv, KD
95700	3 ¹ / ₄ x14x30" long, Galv, ASM

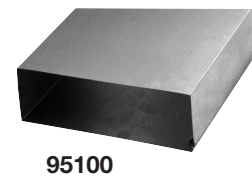

Riser Elbows, 90°

Item	Description
96000	3 ¹ / ₄ x8 Galv, Standard
96100	3 ¹ / ₄ x10 Galv, Standard
96200	3 ¹ / ₄ x12 Galv, Standard
97000	3 ¹ / ₄ x8 Galv, Flat
97100	3 ¹ / ₄ x10 Galv, Flat
97200	3 ¹ / ₄ x12 Galv, Flat

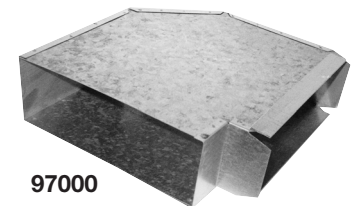
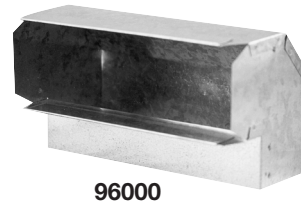

Riser Angles, 45°

Item	Description
98000	3 ¹ / ₄ x8 Galv, Standard
98100	3 ¹ / ₄ x10 Galv, Standard
98200	3 ¹ / ₄ x12 Galv, Standard
99000	3 ¹ / ₄ x8 Galv, Flat
99100	3 ¹ / ₄ x10 Galv, Flat
99200	3 ¹ / ₄ x12 Galv, Flat

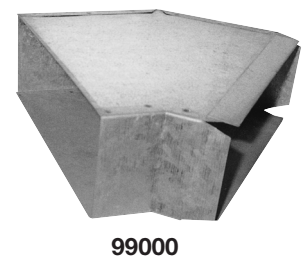
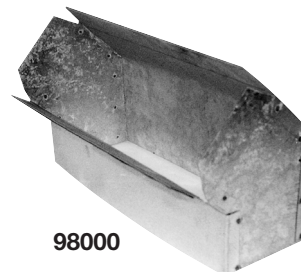

CUSTOM PRODUCTS

Custom products are manufactured to customer specifications and are available in most common gauges of Stainless, Galvanized, Bonderized, Prepainted Steel, Aluminum, Copper, Lead and composite materials.



Sectional Pitch Pocket



Threshold Sill Pans



Coping Miters



Overflow for Downspout



Drain Basins

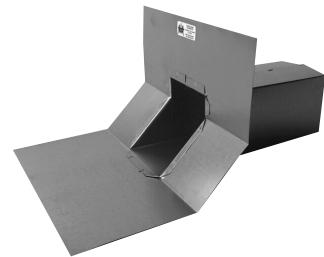

Scupper Outlets



Pelican Hood Tops



Pitched Flashings



Fireplace Shrouds



Eyebrow Awnings

GABLE LOUVERS

(FLANGES ARE NOT INDICATED)

SQUARE TOP

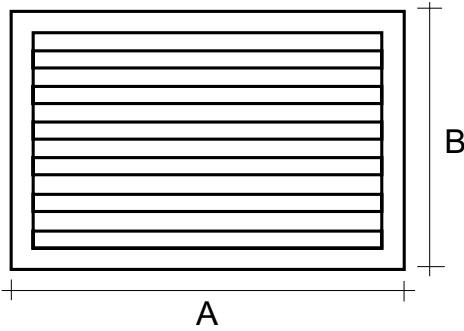

TRIANGLE
(isosceles)

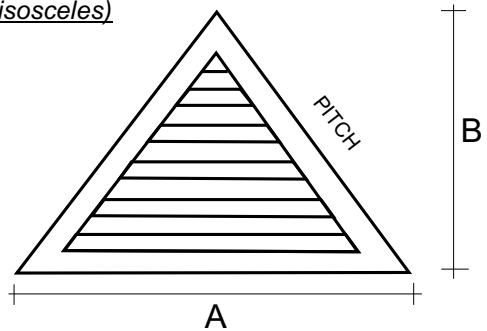

TRIANGLE
(right-angle)

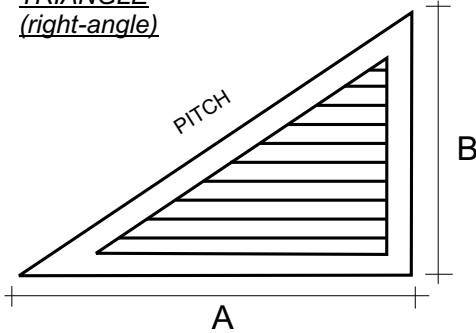

PEAK TOP

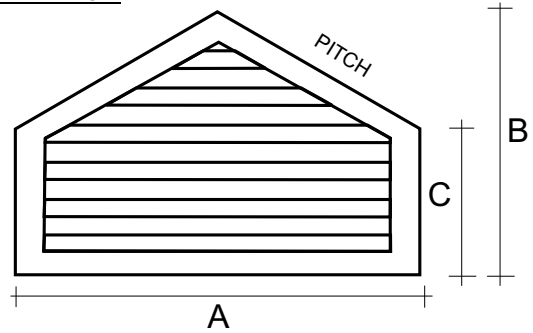

TRAPEZOID

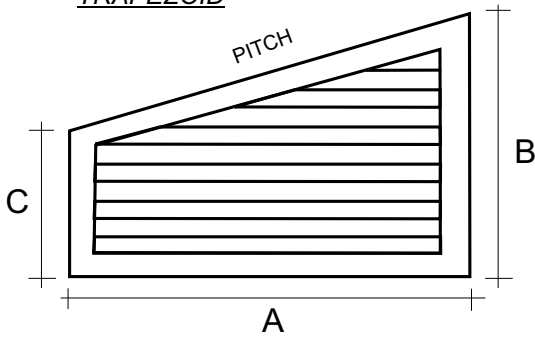

HEXAGON

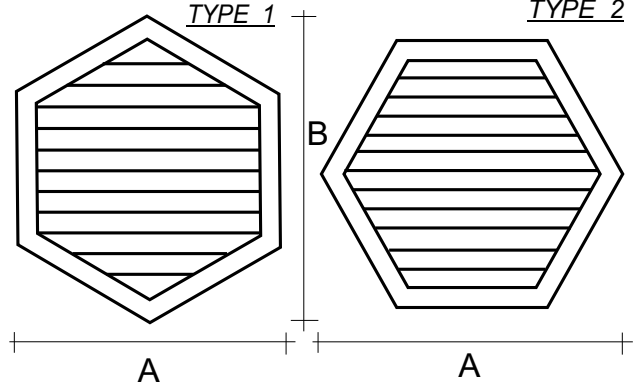

ROUND TOP & ARCH TOP

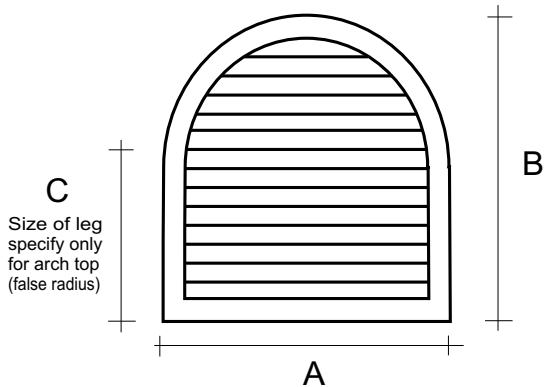

ROUND OR
HALF-ROUND

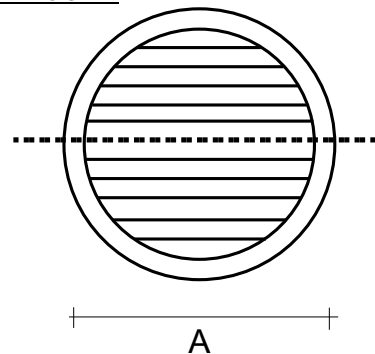

SPECIFICATION FOR LOUVERS AND VENTS

MATERIAL FOR THE FRAME AND BLADES IS ASTM A-653 GALVANIZED, BONDERIZED STEEL OR ZINCALUME. RETURN ANGLE ON BLADE PREVENTS LEAKAGE. MAXIMUM AIR FLOW; SCREENED WITH 1/4" OR 1/8" 23 GA GALVANIZED HARDWARE CLOTH. SOME SEAMS SEALED WITH NON-SAG ELASTOMER SEALANT. SPECIAL STYLES, SIZES AND MATERIALS AVAILABLE UPON REQUEST AND SUBJECT TO QUOTE.

SIDE CUT VIEW

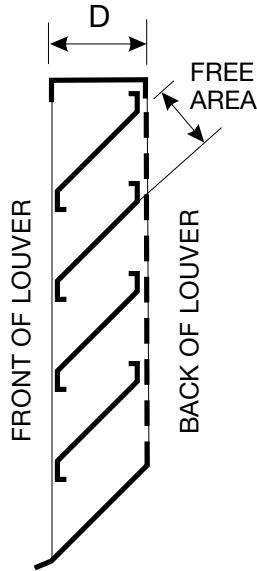

TOP CUT VIEW

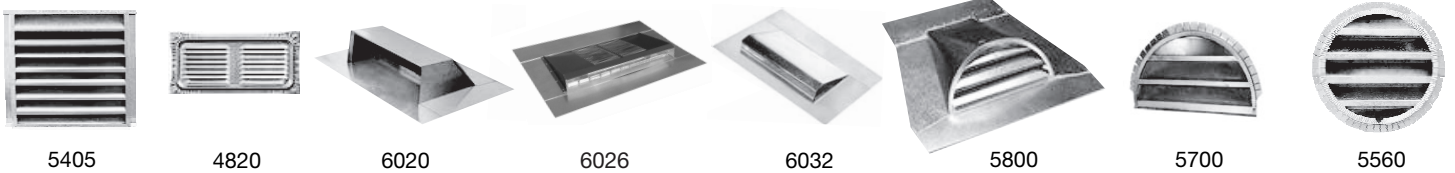
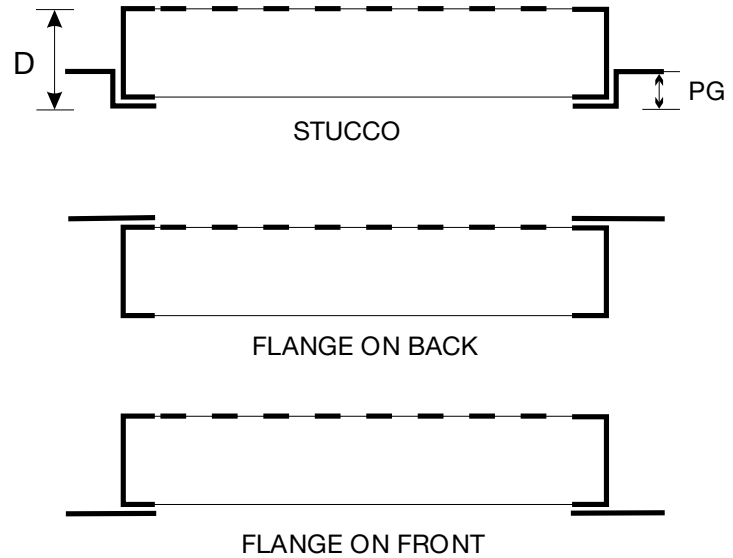

NET FREE AREA IN SQ.IN. (APPROX .)

FOR COMMON LOUVERS AND DORMERS (WITH CATALOG NUMBERS)

SQUARE-TOP LOUVERS

CODE	ITEM	NFA
5300	14 x 9 Galvanized	45
5320	14 x 12 Galvanized	85
5340	14 x 18 Galvanized	125
5360	14 x 24 Galvanized	165
5380	14 x 30 Galvanized	210
5405	18 x 18 Galvanized	160
5410	18 x 24 Galvanized	215
5415	24 x 24 Galvanized	290

HALF-ROUND LOUVERS

CODE	ITEM	NFA
5670	12 Galvanized	25
5680	14 Galvanized	35
5690	16 Galvanized	45
5700	18 Galvanized	70
5710	20 Galvanized	75
5720	24 Galvanized	105
5740	30 Galvanized	200

ROUND LOUVERS

CODE	ITEM	NFA
5500	12 Galvanized	60
5520	14 Galvanized	85
5540	16 Galvanized	100
5560	18 Galvanized	145
5580	20 Galvanized	160
5600	24 Galvanized	280
5620	30 Galvanized	440
5650-1	1 Aluminum	1
5650-2	2 Aluminum	2
5650-3	3 Aluminum	3
5650-4	4 Aluminum	5

DORMER ROOF VENTS

CODE	ITEM	NFA
5800	18x9 Galv/Zinc/Alu.base	50
5870	12x24 Galv/Zinc/Alu.base	100
6026	22x2.5 Galv Glider Vent	73
6032	18 x 4 LP Eyebrow Vent	40

LOUVERED FOUNDATION VENTS

CODE	ITEM	NFA
4820	14 x 6 Galv, w/o mesh	20
4840	14 x 6 Galv, with 1/4" mesh	18

(800) 699 - ABLE
www.ablemetal.com
Quality Since 1946

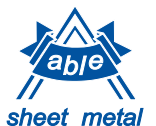

PRODUCTS ALSO AVAILABLE

PVC/TPO (CLAD)

T-TOPS AND FLASHINGS WITH CLAD METAL COMPOSITE BASES

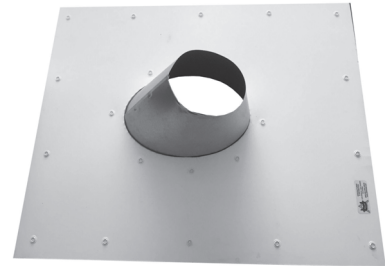
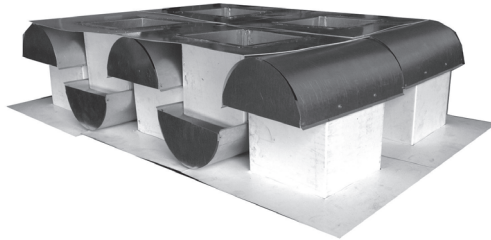
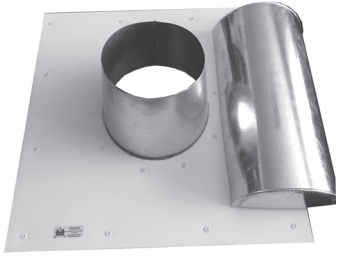

SEAMLESS PIPE FLASHING

FAN JACK

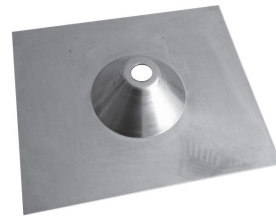
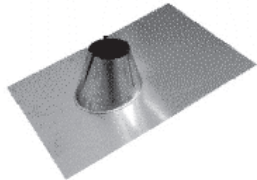
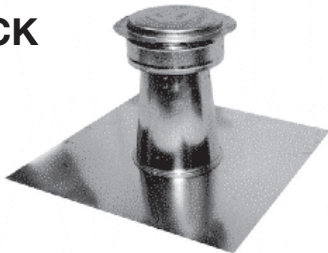

CRICKET SADDLE

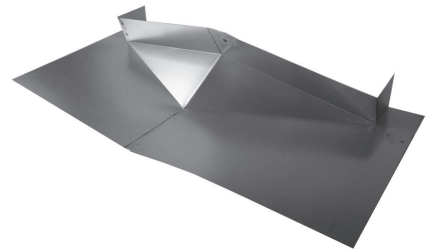

LEAD ROLLS & SHEETS

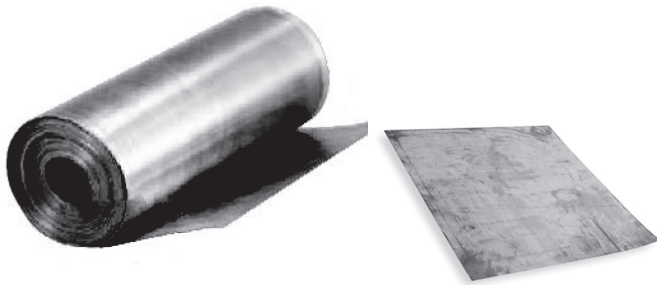

BAR SOLDER

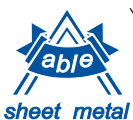

Phone (800) 699-2253

PRODUCTS ALSO AVAILABLE

SEALANT

WeatherMaster™ Ultimate MP Sealant

- Bonds to wet substrates
- Permanently flexible – will not crack
- Ideal for roofing applications, gutters, metal and vinyl siding, windows, doors, air vents, wood, stucco and other common materials



GLOVES



Level 5 Cut-Resistant
seamless knitted yarn with
latex-dipped crinkle finish



STRETCH FILM

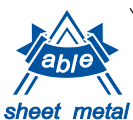

Phone (800) 699-2253

Terms and Conditions of Sale*

This sale is made based on and subject to the terms and conditions of sale set forth as well as all drawings, specifications, descriptions and other documents attached hereto and incorporated herein by reference. Any additional or different terms or conditions set forth in any communication from Buyer, including Buyer's Purchase Order, are hereby objected to by Seller and shall not be effective or binding unless assented to in writing by an authorized representative of Seller.

PRICES AND TAXES: Prices (quoted on separate sheets) for materials covered hereby are subject to adjustment by Able Sheet Metal, Inc. at its shipping points. Seller's prices do not include sales, use, excise or similar taxes. Consequently, in addition to the price specified herein, the amount of any present or future sales, use, excise or other similar tax applicable to the sale or use of the products hereunder shall be paid by the Buyer. All prices will be P.I.E., price in effect, at time of shipment. Prices are subject to change without notice.

PAYMENT: Open account sales have payment terms of net 30 unless otherwise stipulated. All invoices will be dated the day of shipment. Remittance Address: Able Sheet Metal, Inc.; 614 N. Ford Blvd., Los Angeles, CA 90022.

PRODUCT AVAILABILITY: The product offering is subject to the discretion of the Seller.

FREIGHT TERMS: Buyer's orders will be shipped freight collect from Seller's plant location unless orders are in excess of dollar values stipulated by Seller. No freight costs will be paid by Seller for any Buyer's pickups.

DELIVERY AND SHIPMENT: Delivery shall be F.O.B. Seller's factory. Unless otherwise specified upon delivery of materials F.O.B. Seller's plant, all risk of loss, damage and other incidents of ownership shall immediately pass to Buyer. Any routing specified by Buyer will be observed, but Seller shall not be liable for freight allowances, if any, other than that of most economical route. Freight allowances will be made in accordance with Seller's current published price list. Seller reserves the right at all times to control routing.

DELAYS: Seller shall not be liable for delay or failure in performance hereof arising from any cause not within Seller's control, including, but not limited to, accidents, breakdowns or mechanical failure of plant machinery or equipment arising from any cause whatsoever, strikes or other labor troubles; labor shortage, fire, flood, war acts of the public enemy, acts of God, priorities, allocations, limitations or other acts required or requested by Federal or local Governments; or failure of usual sources of supply of materials.

STANDARD TOLERANCES: Seller will produce and ship this order within Seller's limitations as to size, gauge, temper and quality of material in accordance with the Seller's current published price list.

RETURNS: A 20% handling charge plus incurred freight will be made on all material returned. Written authorization by Seller is required. Special or non-stock items are non-returnable.

REMEDIES: In addition to all rights and remedies provided by law, Buyer grants Seller the right to enter Buyer's premises and reclaim all products supplied hereunder which have not been paid for within the prescribed time period.

COMPANY RECOMMENDATIONS: Any recommendations made by Seller, or any of its authorized representatives, concerning uses of or applications of the products sold hereunder are believed reliable but Seller makes no warranty, express or implied, of results to be obtained.

LIMITED WARRANTY: Seller warrants (to the original consumer purchaser) all materials sold hereunder to be free from defects in materials and workmanship at time of purchase. This warranty does not cover, and Seller hereby disclaims all liability for, any product which has been subject to abuse, alteration, modification, neglect, misuse, or abnormal use; or improper storage, handling, installation, or maintenance; or to which parts, not supplied by Seller, have been added; or to defects caused by depreciation or normal wear. The suitability of a product for an intended use shall be the sole responsibility of the user. Seller's liability shall in no event exceed the purchase price paid to it. No person has the authority to change these terms and there are no warranties except as stated herein. Any claim on account of defective materials or for any other cause shall be deemed waived by Buyer unless written notice of such claims is received by Seller within ninety (90) days after date of receipt of materials by Buyer. This warranty is contingent upon Buyer giving Seller prompt notice of any defect appearing within the prescribed time period. Seller shall be given a reasonable opportunity to investigate all claims and no materials shall be returned to Seller until after inspection and approval by Seller and receipt by Buyer of written shipping instructions. Seller's obligation under this warranty is limited to the repair or replacement at its factory of any of the products which are defective in material or workmanship, and is conditioned upon the Buyer furnishing satisfactory evidence that the goods alleged to be defective have been properly installed, maintained, and operated under normal conditions. Seller shall have the option of replacing or repairing any defective materials, refunding the purchase price, or granting a reasonable allowance on account of such defects, and Seller's liability and Buyer's remedies for defective materials shall be limited solely and exclusively as above. This warranty gives you specific legal rights and you may also have other legal rights which vary from state to state. EXCEPT AS EXPRESSLY PROVIDED HEREIN, SELLER MAKES NO OTHER REPRESENTATIONS OR WARRANTIES OF WHATSOEVER NATURE, DIRECTLY OR INDIRECTLY, EXPRESS OR IMPLIED, INCLUDING BUT NOT LIMITED TO ANY REPRESENTATIONS OR WARRANTIES OF SUITABILITY, DURABILITY, FITNESS FOR A PARTICULAR PURPOSE, OR MERCHANTABILITY WITH RESPECT TO THE PRODUCTS.

LIMITATION OF LIABILITY: The statute of limitations applicable to all claims arising under this agreement shall be one year from the date the claim accrues. Seller shall not under any circumstances be liable for special or consequential damages such as, but not limited to, damage or loss of other property or equipment, loss of profits or revenue, cost of capital or cost of purchased or replacement products. The remedies of the Buyer set forth herein are exclusive, and the liability of Seller with respect to any sale, or anything done in connection therewith such as the performance or breach of any terms thereof, or from the manufacture, sale, delivery, resale or use of any products furnished, whether arising out of contract, negligence, strict liability in tort or under any warranty or otherwise, shall not exceed the cost of the products purchased. The parties agree that there is no failure of essential purpose so long as Seller is willing to repair or replace for breach of Seller's warranties herein contained. Any actions brought hereunder must be commenced within eighteen months from the date such cause of action has accrued.

INDEMNIFICATION: Buyer agrees to indemnify, defend and hold harmless Seller, its directors, officers, agents, consignees, employees and representatives from and against all damages, claims, suits, settlements, expenses, including reasonable attorneys fees or liabilities of any kind whatsoever including, but not limited to, breach of warranties, accidents, injuries and losses to or of any person or property wherever, which may arise or be claimed based in whole or in part on Buyer's alteration, modification, assembly or reassembly of any of Seller's products specified herein.

PATENTS AND TRADEMARKS: Except as otherwise provided herein, Seller agrees to defend, at its expense, any suit brought against Buyer based upon a claim that any products provided hereunder infringes any United States Letters Patent, and to pay costs and damages finally awarded in such suit, provided that (a) Seller is notified promptly in writing of the suit and is given assistance for the defense of the same, and (b) Seller shall have sole control of the defense of any suit and all negotiations for its settlement or compromise. In the event a final nonappealable judicial determination is made that products furnished hereunder infringes a valid United States patent, Seller shall, at its option and own expenses, either procure for Buyer the right to continue using such products, replace the same with noninfringing products or modify it so it becomes noninfringing, or remove the infringing products and refund the purchase price and the transportation cost thereof. The foregoing states the entire liability of Seller for patent infringement.

APPLICABLE LAW: Seller reserves any and all rights and remedies provided by law. These terms and conditions of sale shall be interpreted and construed in accordance with the laws of the State of California.

* A compilation of the terms and conditions of sale by American Metal Products and Amerimax Home Products, supplemented by Able Sheet Metal, Inc.

Index

A

Adapters	14
Adjustable Elbows, 90°	14
Air Vents	8
Aluminum Vents	8
Attic Access Doors	6

B

Bead, Casing	2
Bead, Corner	2
Bird-Stop	6
Boots	15
Boxes	16

C

Caps	13
Casing Bead	2
Channel	2
Chimney Caps	11
Chimney Saddle	2
Chimney Stock	2
Conductor Pipe	5
Coping	2
Corner Bead	2
Cornerite	2
Cornice Vents	7
Crawl Hole Doors	6

D

Deck Flashing	2
Diato	2
Diffusers	8
Door Hoods	8
Doors	6
Dormer Roof Vents	9
Double-Wall Vents	13
Down Spout	5
Dryer Vent Sets	8
Drywall Accessories	2
Duct	13

E

Eave Vents	7
Edging / Flashing	1-2
Elbows, Solid	5
Elbows, Adjustable	14

F

Flashings, Roof	1-3
Flexible Aluminum Duct ...	13
Foundation Vents	7

G

Gable Louvers	8-9
---------------------	-----

Glider Vents	10
Gravel Guard	3
Grilles	8
Gutter / Fittings	4

H

HVAC	13-16
Hoods	8

I

Increasesers, Bell-Type	15
-------------------------------	----

J

J-Metal.....	2
--------------	---

L

Lath Accessories	2
Leader Heads	5
Louvers, Half-Round	9
Louvers, Hexagon	9
Louvers, Octagon	9
Louvers, Round	9
Louvers, Round-Top	9
Louvers, Special	9
Louvers, Square-Top	8
Louvers, Triangle-Top	9
Louvers, Triangle	9
Louver Drawings	18
Low Profile Roof Vents	11

O

Outlets (Scuppers)	5
--------------------------	---

P

Pans	14
Pipe, Conductor	5
Pipe, Rectangular Vent	16
Pipe, Riser	16
Pipe, Round Vent	13
Pipe Caps	13
Pipe Collars	13
Pipe Flashings	13
Pitch Pans / Pockets	2
Plaster Accessories	2

R

Rectangular Vent Pipe	16
Reducers, Bell-Type	15
Reducers, Cone-Type	15
Registers	8
Riser Angles / Elbows	16
Riser Pipe	16
Roof Jack T-Tops	11
Roof Jacks, Sq. / Rec.	11

Roof Outlets	5
Roof Ventilators	11
Roof Vents, Assemblies ...	11
Roof Vents, Dormer	9
Roof Vents, Low Profile ...	11
Round Flexible Duct	13
Round Vent Pipe	13

S

Screed	2
Scuppers (Outlets)	5
Seamless Roll Valley	3
Side Hoods	8
Shingles	3
Siding Corners	6
Soffit Vents	7
Specs Louvers, Dormers ..	19
Sq./Rec. Roof Jacks	11
Square-Top Louvers	8
Straps	5

T

T-Tops	11
Tapers	15
Terms and Conditions	22
Three-Way Edging	2
Tile Pan	2
Trim	2
Tub Access Doors	6
Tucker Flashing	2
Two-Way Edging	1
Type B Gas Vents	13

U

Utility Vents	8
---------------------	---

V

Vent T's	14
Vent Y's	14
Vent Flashings	13
Ventilators, Roof	11
Ventilators, Rotary	12
Ventilators, Stationary	12

W

W-Valley	3
Wall Caps	8
Water Table	2

Z

Z Bar	2
-------------	---





sheet metal

quality since 1946

(800) 699 - 2253

www.ablemetal.com

LOS ANGELES BRANCH

*614 North Ford Blvd
Los Angeles, CA 90022
ph.(323)269-2181
fax(323)269-2184*

SAN LEANDRO BRANCH

*14111 Catalina Street
San Leandro, CA 94577
ph.(510)483-9966
fax(510)483-9960*