



INSTALLATION GUIDE

Arc™ 18 & Arc 24 Chamber

IG 8.02
June 2008

The Arc 18 and Arc 24 chambers are an economical, easy-to-install alternative to conventional on-site leachfield systems. In a conventional on-site leachfield system, 4-inch pipe and gravel are used to fill in the excavation. The Arc chamber units eliminate the need for gravel, thereby reducing many of the problems inherent in gravel systems, including compaction, loss of storage, and fines. The open bottom design of the Arc chamber maximizes infiltrative surface area, while its structural design ensures long-term trench integrity. As allowed by state or local code, chamber system designs commonly result in sizing credits that reduce the leach field area required within the field footprint. This affords a decrease in machine time, trucking costs, and labor to the installer and an increase in usable land to homeowners, and developers.

Trench Installation Guidelines

1. Excavate trench to proper width and depth as described in the design and as required by state and local code. Excavation and proper elevation should be set according to a permit formulated from a soil evaluation by the local Health Department, soil scientist, or engineer. For any traffic condition up to an H-10 (16,000 lbs/axle) maximum load limit, the minimum cover over the crown of the chamber shall be 12 inches. For trench installations, a minimum 18-inch wide trench is required for the Arc 18 and a minimum 24-inch wide trench is required for the Arc 24. Adjacent trenches require a minimum of 2-foot separation between lines. (Note: Please check with your State or Local codes for minimum separation between trench lines.)
2. Smooth irregularities in the excavation and trench bottom, then clear any large rocks or debris from the bottom of the trench. Scarify the soil if smearing is present. The drainfield trench bottom or absorption bed should be prepared level. Any allowed slope or fall should be determined and based on your state or local codes.
3. Chamber Assembly

- a. Install the first chamber onto the prepared drainfield. Place dome end first. Each chamber end is marked either Dome (B) or Post (A) on the round observation / vent knockout ports.

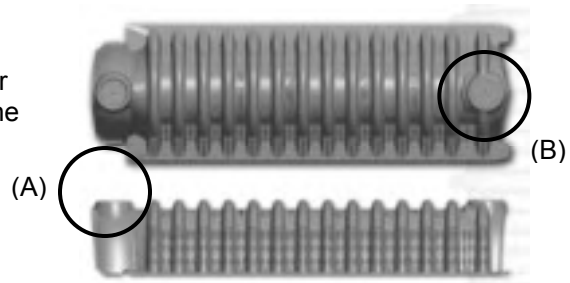

- b. Assemble the Arc chambers in the trench excavation by laying the chamber dome over the post. Raise the post end of the incoming chamber and slightly pull the chamber back until the dome stops at the underlying post.
- c. As the incoming chamber is laid flat in the trench, position the lower base flanges of the incoming chamber under the raised base flanges (C) of the previously-installed chamber. The trench area in front of the raised base flange should be free of rocks, soil clumps or other obstructions to ensure proper base flange engagement.

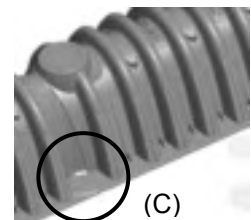

- d. Arc 18 and Arc 24 chambers are designed with an articulating joint that allows for a free-range horizontal rotation of 20 degrees, with a maximum of 10 degrees in either direction. Do not over-rotate the joint beyond 10 degrees.



- e. Each chamber is equipped with a swivel lockout feature (D) located at the base flange of the post end. While the swivel lockout is left in place, the chambers are designed to align in a straight pattern. With the swivel lockout removed, the chamber is free to rotate. The swivel lockout may be removed by cutting along the two sides of the perforation of the lockout and then either moving or removing the remaining piece of plastic from its original position.

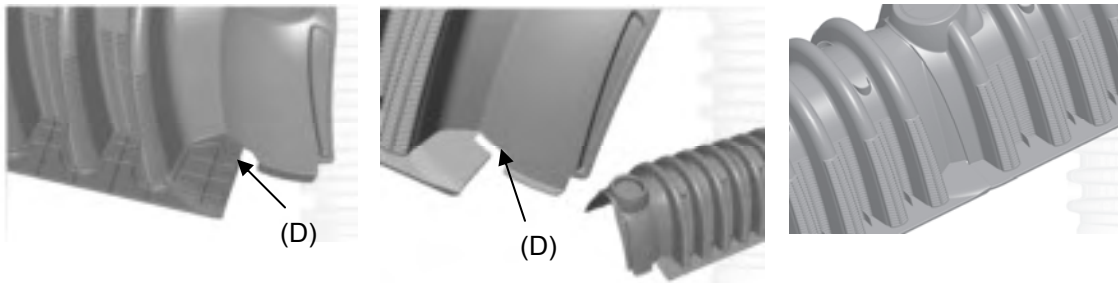

- f. As each chamber is placed in the trench, adjust the trench direction accordingly by removing the appropriate swivel lockout. The incoming chamber base flange will now ride in the removed lockout gap, allowing up to ten degrees of rotation per five-foot chamber.

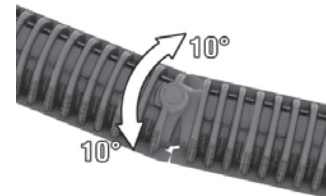

4. Prior to installing end caps, remove the appropriate knockouts for pipe connections by placing the end cap face down on a hard surface and cutting with a hole saw or utility knife. Trim any burrs or excess material with a utility knife. Where a hole saw is used to create a pipe opening, centering dimples are placed in the middle of each knockout for the hole saw pilot bit. The knockout will accept 4" SDR 35, 4-inch Schedule 40, or 4-inch ADS-3000 Triplewall[®] pipe. Inlet pipe nipples must not exceed 2 inches in length. Nipples extending beyond 2 inches will interfere with the chamber and hinder end cap assembly. Upper knockout shall be used for inlet piping. Lower knockouts are provided for return lines or continuous circuit piping in bed or mound systems. Receiving pockets for 6" x 8" splash plates are incorporated into every end cap.

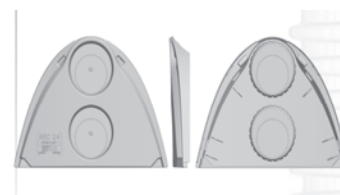
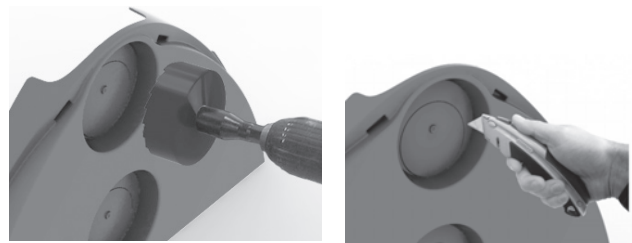

5. Place lip of end cap over the end of the chamber unit and snap into place. Secure in place with backfill. The universal end cap is designed to fit both ends of the Arc 18 and Arc 24 chamber. The end cap shall be placed so that the Arc logo faces outward.

- Where required by local code, a splash plate shall be placed under the inlet end of the chamber. Each end cap is equipped with splash plate receiving pockets. Place the splash plate into the positioning fins prior to end cap assembly.

- Where required, connect serial or manifold lines of the chambers in the same manner as described in steps 4 and 5 above.

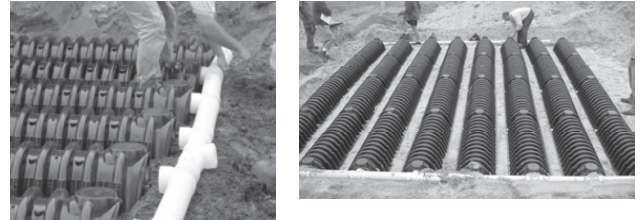

- The post end has small knockouts located on the roof of each chamber. When removed, these knockouts allow for the use of zip ties or straps in order to hang pressure-dosing pipe. Where pressure-dosing pipe is used, end caps should be prepared with a hole saw to adequately accommodate the outside diameter of the PVC dosing pipe.

Knockout

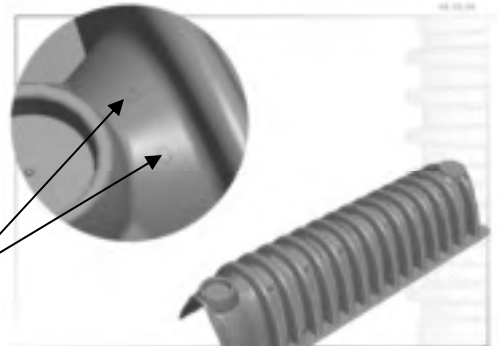

- An easy-knockout inspection port is provided in each Arc 18 and 24 chamber. Once the knockout is removed, the resulting opening will accept 4-inch SDR 35 (4.215" O.D.) or 4-inch Schedule 40 (4.5" O.D.) pipe. The Schedule 40 pipe may require moderate coaxing with a rubber mallet.

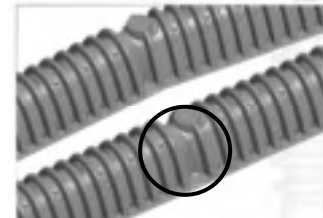

- Fill sidewall area to top of chambers with native soil (or select fill where required). Fill shall be compacted to the minimum requirements necessary for the soil type used. "Walking in" the soil is one acceptable means for achieving the compaction level along the sides of the chamber.



- Complete the backfill of the system with native soil or select fill to the depth specified in the system design and as required by state and local codes. Avoid large rocks and debris in backfill material, as they may eventually impinge on the chamber. As common practice, avoid driving any equipment over the Arc chambers prior to final backfill. Where vehicular loading will be anticipated, all Arc 18 and Arc 24 chambers are approved for H-10 (16,000 lbs/axle) loading when installed with a minimum of 12 inches to a maximum of 8 feet of cover after consolidation*.



- When preparing the final grade, grading shall be such that stormwater is diverted away from the drainfield. System final grade should be crested or sloped, never left flat or concave. Channel storm and downspout water away from the drainfield. Final grading should be slightly to moderately limited soil to help maintain an



aerobic state in the drainfield. Venting is not required. However, venting is recommended to promote oxygen to easily access to the drainfield, and may be required by code.

Bed Installation Guidelines

1. Excavate bed to proper width and depth as described in the design and as required by state and local code. For any traffic condition up to an H-10 (16,000 lbs/axle) maximum load limit, the minimum cover over the crown (top of chamber) of the chamber shall be 12 inches. The total minimum bed depth, when measured to the bottom of the chamber, shall be 24 inches to the bottom of the trench bed for the Arc 18 and Arc 24 chambers for non-traffic applications. For bed type installations, a minimum separation of 4 to 6 inches is required between chamber rows.
2. Smooth irregularities in the excavation and clear any large rocks or debris from the bottom of the bed. Slope of the bed shall be determined based on state or local code.
3. For chamber assembly, see steps 3 through 10 in the Trench Installation Guidelines above.



* Cover height and live loading limits are impacted by both soil type and compaction requirements. Advanced Drainage Systems should be contacted when poor soils are encountered or, if unknown, when fill heights exceed 2 feet.

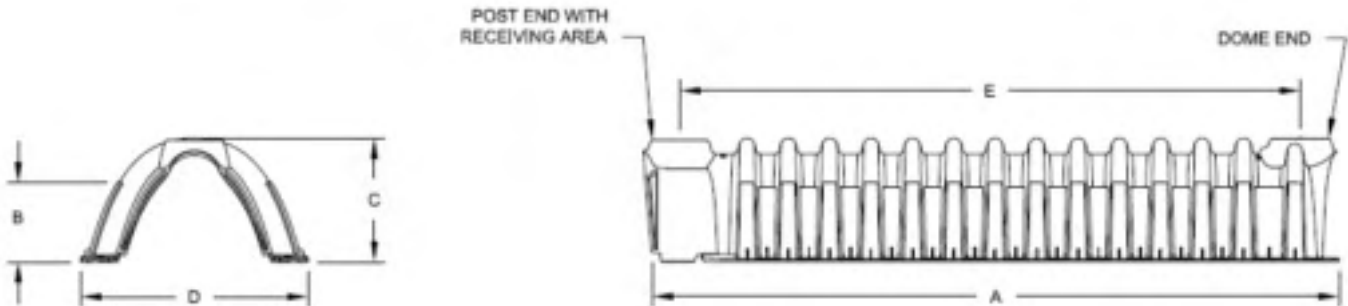

	ARC 18	ARC 24
Length (A)	67 in	67 in
Repeat Length (E)	60 in	60 in
Side Wall Height (B)	7.5 in	7.5 in
Overall Height (C)	12 in	12 in
Overall Width (D)	16 in	22.5 in
Weight	11 lbs	13 lbs
Capacity	3.42 cu ft (25.6 gal)	5.02 cu ft (37.5 gal)