





HYDROPONICS

231–252

Active Aqua	232–237
Active Aqua Premium White Flood Trays	232
Active Aqua Flood Tables	233
Active Aqua Premium White Reservoirs & Covers 	234
Active Aqua Reservoirs, Covers & Ports	235
Active Aqua Domes & Covers	235
Active Aqua Tray Stands	236
Active Aqua Root Spa Complete Deep Water Culture System	237
Emily's Garden™ System	238
Megagarden™ System	238
Tomato Planters	239
Active Aqua Grow Flow Ebb & Flow System	240–241
C.A.P. Ebb & Gro Hydro System	242
The Ebb Monster 6 Pot System	242
Neoprene Inserts 	243
PLANT!T Big Float Auto Top-Up Kit	243
Telescopic Flood Table Groove Brush	243
Hydrofusion Fill & Drain Kit	243
Drill Bit & Deburring Tool	243
Floating Thermometer	243
General Hydroponics	244–247
WaterFarm®	244
Powergrower Eco	244
Ecogrower Max & MegaFarm	245
Eurogrower Drip Hydroponics	245
Rainforest Aeroponics	245
Aeroflo® Aeroponics	246
Snap Stand	247
Panda Reservoir	247
Controller System	247
Texas Controller	247
Covert Tank	247
Botanicare	248–249
Clone Machine	258
Aerojet Aeroponics Hydrogarden	258
Microgarden	258
Daisy Cloner	258
Turbogarden	258
Neoprene Inserts	258
360° Clone Spinner & Aeroponic Mister	258
Power Cloner	259
EZ-Clone Classic Cutting System	259
Aerogarden Countertop Hydroponic Garden 	250
AeroGarden Seed Kits 	251
Lazy Gardener Self-Watering Insert	252



ACTIVE AQUA PREMIUM WHITE FLOOD TRAYS

Active Aqua's new premium white trays offer unparalleled strength and performance. These heavy duty full ID flood trays are thick, rigid, durable, and easy to clean. The tray edge has been arch-formed, which reinforces the tray and minimizes flexing. They feature a square drainage pattern and smooth channels, which simplifies cleaning. Active Aqua's premium white trays are manufactured in seven sizes: 2' x 2', 2' x 4', 2' x 4' tent, 3' x 3', 4' x 4', 3' x 6', 4' x 8'.

- Made in North America
- UV-resistant, virgin ABS plastic cap over a 100% recycled ABS plastic core
- True internal dimensions
- Water level fill height indicators
- Reinforced with a deep, 7" sidewall
- Recessed drain position
- Smooth, rounded corners
- Easy to clean

100% Recyclable!

Strong, durable, and low maintenance

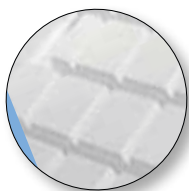

Recessed drain position for better drainage



Arch-formed edge for more strength



Inside gradation for accurate water levels



See our new premium white reservoirs on page 234

ITEM CODE	DESCRIPTION	VOLUME	INSIDE DIMENSIONS	OUTSIDE DIMENSIONS	SRP
HGFTW22P	Active Aqua Premium White Tray, 2' x 2'	15 gal	24" x 24" x 7"	28.5" x 28.5" x 8.5"	\$49.95
HGFTW24P	Active Aqua Premium White Tray, 2' x 4'	30 gal	24" x 48" x 7"	28.5" x 52.5" x 8.5"	78.95
HGFTW33P	Active Aqua Premium White Tray, 3' x 3'	36 gal	36" x 36" x 7"	40.5" x 40.5" x 8.5"	117.95
HGFTW44P	Active Aqua Premium White Tray, 4' x 4'	60 gal	48" x 48" x 7"	52.5" x 52.5" x 8.5"	149.95
HGFTW36P	Active Aqua Premium White Tray, 3' x 6'	72 gal	36" x 72" x 7"	40.5" x 76.5" x 8.5"	189.95
HGFTW84P	Active Aqua Premium White Tray, 4' x 8'	120 gal	48" x 96" x 7"	52.5" x 100.5" x 8.5"	274.95
HGFTW2245T	Active Aqua Premium White Tray for Tents, 22" x 45"	18 gal	42" x 19" x 6"	45" x 22" x 7"	\$69.95



ACTIVE AQUA WHITE FLOOD TABLES

Now our Active Aqua flood tables are available in white in three popular sizes – 2' x 4', 4' x 4' and 8' x 4'. All Active Aqua flood tables feature stronger corners and thicker walls than any others in their class, with multi-drain positions for versatility in setups and rounded corners for easy cleaning.

True full size dimensions & volume

Superior grid pattern design and multi-level drainage channels to promote fast and thorough drainage



HGFTW24
2' x 4'

Rounded corners for easy cleaning

Now available in white!



HGFTW44
4' x 4'

Inside gradation for accurate water levels



HGFTW84
8' x 4'



Tray stands

(See page 236)

ITEM CODE	DESCRIPTION	VOLUME	INSIDE DIAMETER	OUTSIDE DIAMETER	SRP
HGFTW24	Active Aqua 2' x 4' Flood Table, white	20 gal	24" x 48" x 5"	29.5" x 53.75" x 7"	\$61.95
HGFTW44	Active Aqua 4' x 4' Flood Table, white	40 gal	48" x 48" x 5"	53.5" x 53.5" x 7"	102.95
HGFTW84	Active Aqua 8' x 4' Flood Table, white	80 gal	48" x 96" x 5"	53.5" x 101.25" x 7"	214.95

BLACK FLOOD TABLES

Active Aqua flood tables offer features that rival the competition at value prices. Made from durable, high-impact ABS plastic with UV resistance for longevity, with true, full-size dimensions and volume to provide maximum growing area.

ITEM CODE	DESCRIPTION	VOLUME	INSIDE DIAMETER	OUTSIDE DIAMETER	SRP
HGFT22	2' x 2' Flood Table, black	10 gal	24" x 24" x 5"	29.75" x 29.75" x 7"	\$39.95
HGFT24	2' x 4' Flood Table, black	20 gal	24" x 48" x 5"	29.5" x 53.75" x 7"	61.95
HGFT33	4' x 6' Flood Table, black	24 gal	36" x 36" x 5"	41" x 41" x 7"	70.95
HGFT44	4' x 4' Flood Table, black	40 gal	48" x 48" x 5"	53.5" x 53.5" x 7"	102.95
HGFT46	4' x 6' Flood Table, black	60 gal	72" x 48" x 5"	77" x 53" x 7"	159.95
HGFT36	3' x 6' Flood Table, black	48 gal	36" x 72" x 5"	41" x 77" x 7"	134.95
HGFT84	8' x 4' Flood Table, black	80 gal	48" x 96" x 5"	53.5" x 101.25" x 7"	214.95



HGFT33
3' x 3'



HGFT44
4' x 4'



Inside gradation for accurate water levels

Superior grid pattern to promote fast and thorough drainage



HGFT36
3' x 6'



HGFT24
2' x 4'

Rounded corners for easy cleaning

ECONOMY FLOOD TABLES

Our economy flood tables have the same grid pattern, drainage channels, depth charts and dimensions as our Active Aqua tables – at a lighter weight and an even lower price!

Great value!



HGFE24
2' x 4'



HGFE84
8' x 4'



HGFE44
4' x 4'

ITEM CODE	DESCRIPTION	VOLUME	INSIDE DIMENSIONS	OUTSIDE DIMENSIONS	SRP
HGFE24	2' x 4' Economy Flood Table	10 gal	16.5" x 40" x 4"	2" x 47" x 5"	\$59.95
HGFE44	4' x 4' Economy Flood Table	20 gal	40" x 40" x 4"	47" x 47" x 5.5"	84.95
HGFE84	8' x 4' Economy Flood Table	40 gal	40" x 87" x 4"	46.5" x 93.75" x 5.5"	136.95



Premium quality at an affordable price

ACTIVE AQUA PREMIUM WHITE RESERVOIRS & COVERS

The Active Aqua line of premium white reservoirs and covers offers features that rival the competition at value prices. These reservoirs are thicker all around than most other brands, with slightly concave sides to improve strength and avoid bowing. They feature stronger corners and a low profile to fit under flood tables and other hydroponic systems.

- Multi-level drill access points for automated drainage, float valves, or other improvements
- Inside gradation to verify water level
- True, full-size dimensions and volume to provide maximum growing area
- Made from durable, high-impact ABS plastic with UV resistance for longevity
- Stronger corners and thicker walls than any others in their class



HGRES115K
Includes HGRES115PWB, HGRES115PWC, and HGRESPPHC



HGRES70K
Includes HGRES70PWB, HGRES70PWC, and HGRESPPHC



HGRES40K
Includes HGRES40PWB, HGRES40PWC, and HGRESPPHC



HGRES20K
Includes HGRES20PWB, HGRES20PWC, and HGRESPPHC

PREMIUM RESERVOIR COVER & PORTHOLE COVER

Our premium reservoir covers are slightly convex with a ribbed design for strength. They fit inside the reservoir top to guarantee that any water that may collect on top falls back into the reservoir. They feature a convenient access porthole (cover available separately) and multi-drill access points to install various meters and pump cords. Porthole cover fits all of our premium reservoir covers.

PREMIUM RESERVOIR KITS

Our convenient Premium Reservoir Kits include one reservoir, one cover, and one porthole cover – a great value at an affordable price.

ITEM CODE	DESCRIPTION	DIMENSIONS	SRP
HGRES115K	115 gal Reservoir Kit Premium White	52.75" x 47.25" x 15"	\$364.95
HGRES70K	70 gal Reservoir Kit Premium White	55.25" x 38.25" x 12"	268.95
HGRES40K	40 gal Reservoir Kit Premium White	38.5" x 33.5" x 12"	144.95
HGRES20K	20 gal Reservoir Kit Premium White	31.5" x 24.5" x 11"	104.95
HGRES115PWB	115 gal Reservoir Premium White	52.75" x 47.25" x 15"	\$238.95
HGRES70PWB	70 gal Reservoir Premium White	55.25" x 38.25" x 12"	185.95
HGRES40PWB	40 gal Reservoir Premium White	38.5" x 33.5" x 12"	89.95
HGRES20PWB	20 gal Reservoir Premium White	31.5" x 24.5" x 11"	61.95
HGRES115PWC	115 gal Res Cover Premium White	52.75" x 47.25" x 1.25"	\$146.95
HGRES70PWC	70 gal Res Cover Premium White	55.25" x 38.25" x 1.25"	95.95
HGRES40PWC	40 gal Res Cover Premium White	38.5" x 33.5" x 1.25"	57.95
HGRES20PWC	20 gal Res Cover Premium White	31.5" x 24.5" x 1.25"	42.95
HGRESPPHC	Premium White Porthole Cover	9" x 6" x 1"	\$8.95



RESERVOIRS, COVERS & PORTS

Our line of flood tables, reservoirs and covers offer features that rival the competition at value prices.

- True, full-size dimensions and volume to provide maximum growing area
- Made from durable, high-impact ABS plastic with UV resistance for longevity
- Low profile to fit under flood tables and other hydroponic systems

- Slightly convex & ribbed cover design for strength and drainage of any water that may collect on top
- Convenient access port hole (available separately)
- Superior grid pattern design and multi-level drainage channels to promote fast and thorough drainage
- Rounded corners for easy cleaning

Add a floating thermometer for temperature at a glance!

Easy and accurate readings of your water temperature, with a pressure sensitive backing for easy mounting. Features readings in both celsius and fahrenheit, as well as clear markings that delineate ideal nutrient temperature.



HGRESPHC
Port Hole Cover
(fits all sizes)

HGRES100B
100 gallon, 53" x 53" x 13"
(shown with optional lid)

Stronger corners and thicker walls than any others in their class

Cover fits inside so water falls back into reservoirs

Slightly concave sides are stronger and avoid bowing

Multi-level drill access points for drainage, float valves, meter and pump cords, etc.



Easy to read depth chart embossed in side panel makes measuring a cinch



Super low profile design

ITEM CODE	DESCRIPTION	SRP
HGRES25B	25 gal Reservoir, 30"x30"x13"	\$65.95
HGRES50B	50 gal Reservoir, 39.5"x39.5"x13"	96.95
HGRES75B	75 gal Reservoir, 46.5"x46.5"x13"	136.95
HGRES100B	100 gal Reservoir, 53"x53"x13"	189.95
HGRES25C	25 gal Reservoir Cover, 7"x27"	\$34.95
HGRES50C	50 gal Reservoir Cover, 36.5"x36.5"	47.95
HGRES75C	75 gal Reservoir Cover, 43.5"x43.5"	66.95
HGRES100C	100 gal Reservoir Cover, 50"x50"	93.95
HGRESPHC	Porthole Cover, fits all sizes	8.95
HGFLT	Floating Thermometer	\$2.09

ACTIVE AQUA DOMES & COVERS

Active Aqua humidity domes fit our flood tables perfectly and feature 3-way ventilation for superior temperature and humidity control with vents on the top and on the side. These tall (8.5" high), sturdy domes accommodate larger plants for increased growing volume. Our white flood tray covers reflect light to minimize heat buildup.



HGFTDM24
2' x 4'



HGFT44COV
4' x 4'

Dome features patented design with open and close 3-way ventilation on center top vent
Taller dome for higher growing volume

Patented design



Two adjustable side vents



ITEM CODE	DESCRIPTION	SRP
HGFTDM22	2' x 2' Humidity Dome (fits HGFT22)	\$69.95
HGFTDM24	2' x 4' Humidity Dome (fits HGFT24)	134.95
HGFTDM33	3' x 3' Humidity Dome (fits HGFT33)	103.95
HGFT24COV	2' x 4' Flood Table Cover (fits HGFT24)	\$66.95
HGFT33COV	3' x 3' Flood Table Cover (fits HGFT33)	87.95
HGFT44COV	4' x 4' Flood Table Cover (fits HGFT44 and HGFTW44)	145.95



Reinforced steel tray stands offer strength & mobility for your flood trays!

ACTIVE AQUA TRAY STANDS

Active Aqua tray stands offer strength and mobility for all scenarios involving use of specific propagation flood tables. The reinforced steel structure with casters is easy to assemble, features an attached light hanging cross bar, and supports flood tables for even tray balance, equal water distribution, and drainage. The low profile design ensures trays are positioned directly over reservoirs so more vertical space is available for plant growth.

Measurements (all stands):

- Extendable light bar adjusts from 51" to 73"
- 20" clearance for reservoirs
- Top of tray is 30" from the ground when in the tray stand



ITEM CODE	DESCRIPTION	SRP
HGSFT24	2' x 4' Tray Stand w/Hanging Bar	\$166.95
HGSFT44	4' x 4' Tray Stand w/Hanging Bar	261.95
HGSFT84	8' x 4' Tray Stand w/Hanging Bar	379.95

Compatible with Hydrofarm trays and other brands



Fill the Root Spa with your favorite nutrient solution and watch your plants grow!

ROOT SPA COMPLETE DEEP WATER CULTURE SYSTEM

The Root Spa Deep Water Culture System is a fun and simple DIY bucket system that offers an effective method for delivering optimal levels of water, nutrient, and oxygen to your plants. Fill up The Root Spa with your favorite nutrient solution and watch your plants grow! After a very short time, you will realize the advantage of the simplicity of this uniquely easy-to-use, inexpensive, and forgiving system! Pumping raw air into the nutrient solution, without the need of expensive and often troublesome air stones, is not only cost effective, but your plants will also thrive!

Includes:

- DIY bucket (HG5DIYB – see page 299) – also available with 4 and 8 buckets
- 10" bucket basket to hold your choice of growing medium
- Multipurpose air hose to deliver air from the pump to the bottom of the bucket
- External air pump to oxygenate your water to encourage root growth
- .5" grommet fitting
- .5" elbow fitting
- .25" black tubing
- Air hose retainer
- Instruction manual

Clay pebble media sold separately.



Ideal for use with clay pebbles

See page 137

Easy to assemble & use – no tools required!



1. Attach tubing to air pump.

2. Insert other end of tubing into the multipurpose air hose.

3. Turn on the pump to deliver air to the bottom of the bucket



RSSGALSYS includes EMPUMP air pump with 1 outlet



RSSGAL4SYS includes AAPA15L air pump with 4 outlets



RSSGAL8SYS includes AAPA25L air pump with 8 outlets



ROOT SPA

ITEM CODE	DESCRIPTION	SRP
RSSGALSYS	Root Spa DIY Bucket System	\$34.95
RSSGAL4SYS	Root Spa DIY 4 Bucket System	119.95
RSSGAL8SYS	Root Spa DIY 8 Bucket System	199.95
HG5DIYB	Replacement DIY Bucket, 5 gal	\$6.95
HG5DIYL	DIY Bucket Lid	2.95



See video of the Root Spa in action!

EMILY'S GARDEN™ SYSTEM

This 6"H x 16"W x 24"L garden with 6 individual planters allows you to rotate or add new plants as you please. It will fit just about anywhere – on a bench, a shelf, table, or out on the patio. Also available without media so you can customize your system with media of your choice.

System includes:

- 2 gal reservoir
- Growing media
- UL-listed air pump
- Tubing
- Six 7"H x 6"W x 6"L planters
- Seed starter cubes
- Molded cover
- Nutrient
- Water level indicator
- pH test kit
- Illustrated instructions



Grow media & starter cubes included; also available without media – see our website for suggested media.

Water level indicator



Add a Mini Sunburst

(See page 32)



For extra growing power light up with our Sunburst all-in-one grow light

ITEM CODE	DESCRIPTION	SRP
EMSYST	Emily's Garden System	\$99.95
EMSYSTEM	Emily's Garden – No Media	\$89.95

MEGAGARDEN™ SYSTEM

Get the convenience of an ebb & flow system in a 10"H x 22"W x 22"L size garden. Ebb & flow systems work by pumping nutrient solution up from a reservoir to a controlled water level tray. All plants are watered uniformly on a timed cycle. Also available without media so you can customize your system with media of your choice.

System includes:

- 7.5 gal reservoir
- Growing media
- Insert grow tray
- Fifteen 5.5" square planters
- Submersible pump and timer
- Nutrient
- Seed starter cubes
- pH test kit
- Water level indicator
- Illustrated instructions



15 planters

Pump & timer



Grow media & starter cubes included; also available without media – see our website for suggested media.

Water level indicator



ITEM CODE	DESCRIPTION	SRP
MGSYS	MegaGarden System	\$179.95
MGSYSNM	MegaGarden, No Media	\$159.95

TOMATO PLANTERS

Hydrofarm's self-watering tomato planters provide lightweight, strong support for tomatoes, beans, peas, and other climbing plants, and flowers. An easy-fill reservoir system delivers water and nutrients from below, helping avoid over- or underwatering. The sturdy frame construction helps support the weight of vines as they grow, allowing the plant to devote more energy to developing fruit – and preventing the fruit from falling off before it's ripe.

- Expandable – as plants grow, just add extra risers or rings
- Convenient watering port makes refilling easy
- Simple to assemble – no tools required
- Breaks down for easy storage
- Durable plastic construction

TOMATO BARREL™

GCTB

- Trellis expands to 4 feet tall
- Planter holds .75 cu ft
- Reservoir holds 1.5 gallons
- Includes round base and planter, 4 support rings, and 4 connecting risers
- Extra rings & risers available separately – make your own tomato cage! (Item #GCTC)

SIZE: 14.75" dia. x 11.5" tall



GCTB

Watering port

TOMATO & PEPPER TREE™

GCTT

- Trellis expands to 3 feet tall
- Planter holds .75 cu ft
- Reservoir holds .75 gallons
- Includes square base and planter, 3 support rings, and 3 connecting risers

SIZE: 11" W x 11" W x 8" H



Trellis ring

GCTT

Self-watering planter

Water reservoir

TOMATO TRELLIS™

GARDEN ON WHEELS GCTR

- Trellis expands to 4 feet tall
- Planter holds 1.5 cu ft
- Reservoir holds 2.5 gallons
- Includes rectangular base and planter, 3 risers with supports, and 2 side support brackets

SIZE: 13.5" W x 13.75" H x 29" L

Great for peppers and tomatoes!

GCTR



Wheels & handle make moving easy

a Hydrofarm exclusive



Snap together trellis

Watering port

TOMATO CAGE™

GCTC

- Three ring extension
- Expands to 4 feet tall

SIZE: 14.25" dia. x 13.5" risers



ITEM CODE	DESCRIPTION	SRP
GCTB	Tomato Barrel with 4 ft Tower	\$29.95
GCTT	Tomato Tree with 3 ft Tower	19.95
GCTR	Tomato Trellis with 4 ft Trellis	47.95
GCTC	Tomato Cage Extension	\$7.95



Features and flexibility you want at a price you can afford

Active Aqua's Grow Flow is the most efficient ebb & flow system on the market. With the Grow Flow's easy-to-program controller unit, you can pretty much "set it and forget it." And since your pumps are only pumping a short time each day, the system is extremely reliable and efficient. Just set the fill drain cycles and the controller unit does the rest!

As for safety, the Grow Flow is the only unit available with fail-safe overflow protection. If the float valve stops operating, the LED indicator lights up on the control panel and the emergency shut-off valve automatically shuts down the system, preventing any spillage or damage to your growing area.

Have bigger plans? Expand your system to up to 48 growing modules with the convenient Grow Flow or Grow Flow 2.0 Expansion Kit, or you can build your own system from the ground up by purchasing all the components individually.

GROW FLOW EBB & FLOW SYSTEM

The updated Grow Flow System has everything you need to get started, right down to the fittings and tubing. Save money in your initial setup with this 12-site complete system.

- Digital controller with 3-year warranty
- Adjustable fill height
- 3/4" (13 mm) tubing and fittings make for fast flood and drain times
- 55-gallon distribution reservoir
- Two 250 GPH high-flow pumps
- Twelve bucket modules

EFFICIENT, CONVENIENT CUSTOMIZABLE

Available as a 12-site Complete System, or create a custom setup by purchasing individual components.

- Connect 6 to 48 growing modules to a single system
- Adjustable float ladder and emergency shut-off valve
- LED emergency indicator light
- Each growing module consists of one outer bucket and one inner bucket – making it easy to lift and move plants
- 3/4" (13 mm) tubing and fittings make for fast flood and drain times
- Water pumps operate on 120V

Updated system comes with heavy duty square 5-gallon pots and 3/4" fittings



For the ultimate in customization, purchase Grow Flow components separately and build your own system

Heavy duty Grow Flow 2.0 Expansion Kit



GROW FLOW 2.0 EXPANSION KIT (GFOE3) 5 GALLON

The new Grow Flow 2.0 Expansion Kit includes six growing modules, each consisting of a square, heavy-duty, 5-gallon pot with 3/4" fittings, an inner bucket, and all necessary fittings and tubing. Each pot features concave bottom with multiple drain holes for better water flow.

GROW FLOW EXPANSION KIT (GFOE2) 2 GALLON

The Grow Flow Expansion Kit includes six growing modules, each consisting of a round 2-gallon pot with 1/2" fittings, an inner bucket, and all necessary fittings and tubing. Each pot features concave bottom with multiple drain holes for better water flow.

GROW FLOW CONTROLLER UNIT (GF07CB)

Each Grow Flow Controller Unit w/3-year warranty can control up to 48 growing modules. Includes one 7-gallon controller bucket, premium Grasslin® timer, two 250 GPH pumps, all fittings, 1/2" tubing for pumps, and sample nutrients.



55 GALLON RESERVOIR DRUM (HG55DRUM)

The multi-purpose, heavy-duty reservoir barrel is made of high-density polyethylene so it's lightweight and won't dent, rust, or peel. Easy to read levels are marked on the side. Open head design includes plastic lid with pre-drilled opening and metal clamp for secure closing. Dimensions: 22.0"L x 22.0"W x 36.0"H. (A lid without holes is available separately—not shown: item # HG55LID).

- Easy to read levels on side
- Lid clamps securely



GROW FLOW 1/2" AND 3/4" HARDWARE KITS (GFTH AND GFEH)

The Grow Flow Tee Hardware Kit (GFTH) includes six each of 1/2" tees, drain tees, and mounting nuts, and 12 washers.

The Grow Flow Elbow Hardware Kit (GFEH) includes six each of 1/2" elbows, drain screens, and mounting nuts, and 12 washers.

SUBMERSIBLE PUMP (GFOPUMP)

The Grow Flow Submersible 120V, 251 GPH pump is recommended for 25 gallon reservoirs. Great for indoor or outdoor use, it's oil free and environmentally safe.

An inside look at the Grow Flow Controller

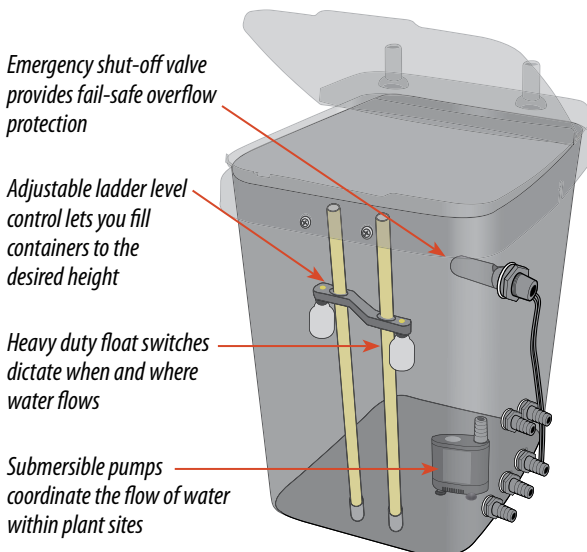

COMPARE:	GROW FLOW EBB & FLOW COMPLETE SYSTEM	GROW FLOW EBB & FLOW CONTROLLER UNIT	GROW FLOW EXPANSION KIT	GROW FLOW PRO EXPANSION KIT
Item Code	GF07KT	GF07CB	GFOE2	GFOE3
INCLUDES:				
Controller Unit	1	1		
Submersible Pump	2	2		
Tubing & Fittings	Yes	No*	Yes	Yes
2-Gallon Pots			6	
5-Gallon Pots	12			6

*Includes 1/2" tubing for pumps

ITEM CODE	DESCRIPTION	SRP
GF07KT	Grow Flow Ebb & Flow 12-Site Complete System	\$499.95
GF07CB	Grow Flow Ebb & Flow Controller Unit w/2 pumps	\$279.95
GFOE2	Grow Flow Expansion Kit w/six 2-gal round pots	69.95
GFOE3	Grow Flow 2.0 Expansion Kit w/six 5-gal square pots	89.95
GFTH	Grow Flow Tee Hardware Kit (6/pk)	\$11.97
GFEH	Grow Flow Elbow Hardware Kit (6/pk)	11.97
HG55DRUM	55 Gallon Reservoir Drum w/Pre-Drilled Lid	\$124.95
HG55LID	55 Gallon Drum Lid (not shown), No Holes	14.95
GFOPUMP	Grow Flow Submersible Pump 251 GPH	\$19.95

EBB & GRO HYDRO SYSTEM AND COMPONENTS

The Ebb & Gro system works by connecting all of the grow pots to the controller unit. All necessary tubing is included with the system. Just set the timer and the system will fill and drain the pots three to four times a day. When the fill and drain cycle comes on, it turns on the pump in the large reservoir (the 55 gallon drum) and starts filling the controller unit. Since the grow pots are all plumbed to the controller unit, the water in the entire system starts to level off with the controller unit. When the pots are full, and your drain cycle starts, the pump in the controller unit pumps all of the water back into the reservoir. When the level of the water in the controller unit goes down, all of the grow pot's levels go down also. Then the controller unit waits for the next fill and drain cycle a few hours later.

EBB & GRO EXPANSION KIT *CAEBBEXP6*
Expand your Ebb & Gro hydroponic system up to 48 modules! Includes six 2-gallon modules with perforated grow pots, and all tubing and fittings. Connects to existing controller and 55-gallon reservoir.

EBB & GRO CONTROLLER UNIT *CAEBBCTR*
Includes 2 pumps and a 3.5 gallon reservoir – you supply the pots. This is the same controller unit that comes with the Ebb & Gro Hydro System.



System expands up to 48 modules



ITEM CODE	DESCRIPTION	SRP
CAEBB12	Ebb & Gro Hydro System, Complete	\$549.95
CAEBBEXP6	Ebb & Gro Expansion Kit, 6 Pots, Tubing & Fittings	\$74.95
CAEBBCTR	Ebb & Gro Controller Unit w/ 2 pumps, 3.5 gal reservoir	274.95

THE EBB MONSTER 6 POT SYSTEM

Comes complete with a 55 gallon reservoir and the Ebb Monster Controller Module to efficiently and effectively transfer nutrients to your plants on whatever schedule you set. Includes six 5-gallon grow pot sets, 3/4" tubing, and fittings.

EBB MONSTER CONTROLLER *CAEBBMCTR* The backbone of our EBB Monster System, now available as a standalone controller. Use to control the fill and drain cycles on the schedule you set.



Expandable up to 12 sites



ITEM CODE	DESCRIPTION	SRP
CAEBBM6	Ebb Monster Kit w/6 Pots, Controller & 55 Gal Drum	\$639.95
CAEBBMEXP3	Monster Grow 3-Pot Expansion Kit	82.95
CAEBBMRCKIT	Ebb Monster Kit, 55 Gal Drum, 3.5 Gal Controller & Pumps	459.95
DRMM55GL	Ebb Monster 55 Gal Reservoir w/Un-Drilled Lid	124.95
CAEBBMCTR	Ebb Monster Controller Module Only	274.95

NEOPRENE INSERTS



These neoprene inserts are pre-slit and come in convenient sheets. Available in black or mixed color packs to help you keep track of cutting varieties.



ITEM CODE	DESCRIPTION	SRP
HGNE02B	Neoprene Insert 2", Black – 35/pk	\$13.95
HGNE02MC	Neoprene Insert 2", Mixed Colors – 100/pk	\$39.95
HGNE03B	Neoprene Insert 3", Black – 25/pk	\$19.95

PLANT!T BIG FLOAT AUTO TOP-UP KIT



The PLANT!T BigFloat Auto Top-Up kit lets you connect a secondary header tank to your existing reservoirs – then, using gravity and a low-pressure float valve, it automatically tops-up and maintains nutrient levels in your system. Spend less time filling and inspecting your tanks, and protect your plants from drying out if your reservoir runs low. No pump required. The kit contains everything you need – simply attach to the header tank of your choice up to 400 L (sold separately). Includes:

- 1 x 2 meters 13 mm flexible pipe
- 1 x 13 mm barbed tee
- 1 x 13 mm nut and tail with .75" BSP
- 1 x 13 mm poly to hose connector
- 1 x grey low pressure float valve



ITEM CODE	DESCRIPTION	SRP
GMBF	Plant!t Big Float Auto Top-Up Kit	\$24.95

TELESCOPIC FLOOD TABLE GROOVE BRUSH

Clean flood tables from a standing position! Telescopic handle and stiff nylon bevel cut bristles to help clean hard-to-reach corners and inner channels. Pivoting brush head measures 7.5".



ITEM CODE	DESCRIPTION	SRP
HGSB	Telescopic Flood Table Groove Brush	\$39.95



HYDROFUSION FILL & DRAIN KIT

Fill and drain kit for non-electric siphoning pumps. Faucet adapter changes ordinary faucets into hose threads. Super Pump can create over 20 lbs. of vacuum and is non-electric. Hose shut-off valve allows you to shut off at the filling point. Hose guard's micro screen and grill prevent debris from getting into the pump.



ITEM CODE	DESCRIPTION	SRP
HF101	Hydrofusion Fill & Drain Kit	\$19.95

DRILL BIT FOR DRAIN INSTALLATIONS & DEBURRING TOOL

1/4" to 1 3/8" step in 1/8" increments drill bit for plastic containers. Don't forget to also purchase a deburring tool (at right) to get a leak-free installation of drains and fittings. Quickly removes sharp edges – use on all plastic modifications. Great for removing burrs from holes drilled in lids and grow trays. Eliminates the chances of leaks created by an uneven drainage hole.



ITEM CODE	DESCRIPTION	SRP
HGDRBT	Drill Bit for Drain Installations	\$29.95
HGDEBURR	Deburring Tool	12.95

FLOATING THERMOMETER

Easy and accurate, this gauge floats and has a pressure-sensitive backing for easy mounting. It features readings in both celsius and fahrenheit, as well as clear markings that delineate ideal nutrient temperature.



ITEM CODE	DESCRIPTION	SRP
HGFLT	Floating Thermometer	\$2.09



WATERFARM®

The WaterFarm is built out of high-impact plastic to assure a long service life. Unique square design allows growers to closely pack WaterFarm modules in order to create large, high-density installations. Will grow small, medium, and large plants. It has large water capacity and low water requirements, simple and efficient. As it offers all the features of larger systems at a lower cost without sacrificing quality or performance, the WaterFarm is one of the very best buys.

WATERFARM COMPLETE

Includes 4-gallon reservoir, grow chamber, farm kit, pump, tubing, nutrients and media.



GH4120

Sold as complete kit or individual components

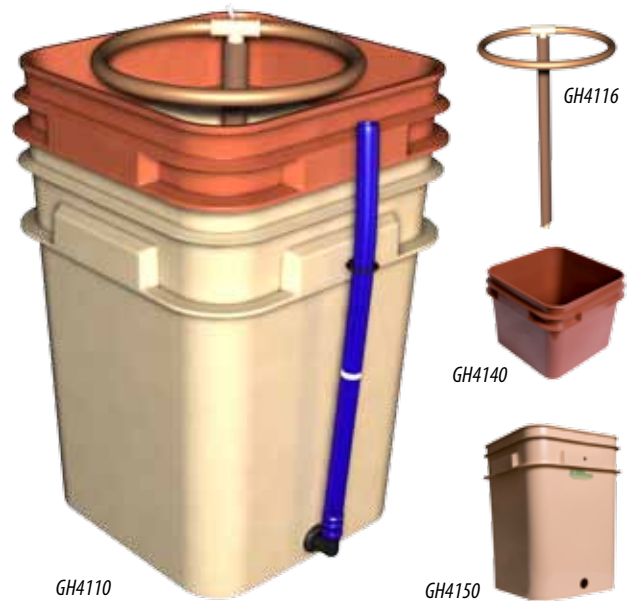

GH4110

GH4116

GH4140

GH4150

ITEM CODE	DESCRIPTION	SRP
GH4120	WaterFarm Complete	\$65.63
GH4110	WaterFarm Module w/ Farm Kit	46.00
GH4116	Waterfarm Farm Kit (10/cs)	\$14.30
GH4140	Waterfarm Replacement Grow Chamber	13.00
GH4150	WaterFarm Replacement 4 Gal Reservoir	25.00

WATERFARM® 8-PACK

The WaterFarm 8-pack is eight WaterFarm module units connected to one General Hydroponics Controller consisting of an integrated 13-gallon reservoir and an 8-gallon controller unit. The Controller will keep each unit topped off with the correct level of nutrient for low maintenance. The kit is powered by GH's dual diaphragm air pump and includes all the necessary hardware, supplies, and General Hydroponics Flora Series nutrients. Arrange the WaterFarm units in a design suitable for any environment. Pack them tight or space them out for your growing situation. The WaterFarm 8-Pack is the system for big growers.

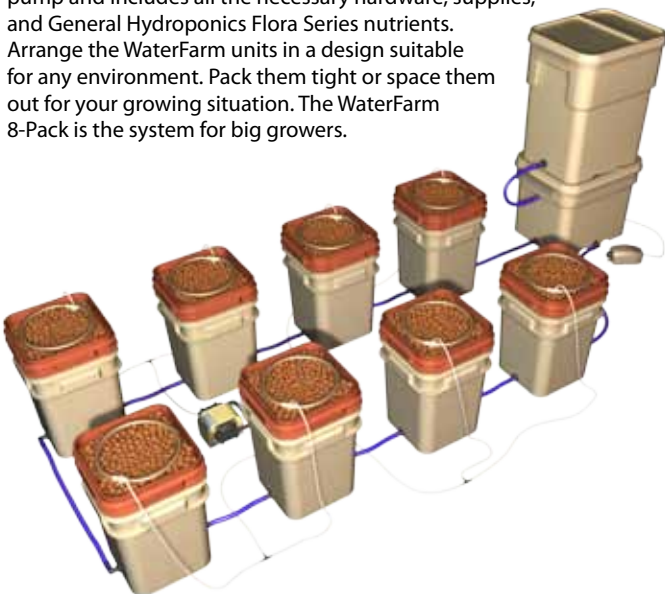

ITEM CODE	DESCRIPTION	SRP
GH4720	WaterFarm Controller Kit – Terra Cotta (Includes 8 Farms & Controller)	\$514.60

POWERCROWER ECO

The PowerGrower Eco incorporates numerous design innovations and is protected by several patents. It is 15" across the top and 15" tall and consists of a single growing chamber at the top with an integrated reservoir below. The unique hexagonal shape lets you place units close together when plants are small, and then separate them as the plants mature and grow.



ITEM CODE	DESCRIPTION	SRP
GH4830	Power Grower Eco Complete	\$80.12
GH4831	Power Grower Eco Module	54.19
GH4832	Power Grower 8 Pack (2 box)	687.48



ECOGROWER MAX & MEGAFARM

THE ECOGROWER incorporates an air driven "spider" drip system and a revolutionary 17-gallon hexagonal reservoir with removable 6" lid inserts. Each lid insert accommodates one 6" net pot. Dimensions: 2' x 2' x 2'.

THE MEGAFARM is GH's largest (22" x 22" x 22") drip hydroponic module. The unique 20-gallon growing chamber sits on top of a 20 gal reservoir. A dual drip ring is utilized to allow for unlimited planting options. The MegaFarm will grow all sizes of plants, including many varieties of trees. Large water capacity and low water requirements make the MegaFarm simple and efficient.



GH4920



GH8005

ITEM CODE	DESCRIPTION	SRP
GH4920	EcoGrower Max	\$233.75
GH8005	MegaFarm	387.00

EUROGROWER DRIP HYDROPONICS

Ideal for new hydroponic gardeners, the Eurogrower provides users with a simple, yet efficient approach to home hydroponics. The heart of the system is the custom designed 40-gallon Panda reservoir, which is more than adequate for its eight 2-gallon buckets. Whether using a soil or soilless medium, growers can use the EuroGrower virtually anywhere. Comes complete with Flora Series nutrients.



GH5400

ITEM CODE	DESCRIPTION	SRP
GH5400	EuroGrower, 8 Pots Complete	\$616.65

RAINFORREST 318/236/66 AEROPONICS

Perfect for propagating cuttings or for starting seeds, seedlings, or transplants. The Vortex Sprayer lifts and oxygenates nutrient solution then gently distributes it over cutting base or root system, for more oxygen in the root zone. Start plants in RainForest modules and later transplant them into larger systems like our WaterFarm. Several RainForest modules can be connected to a Texas Controller for larger installations.



GH6600

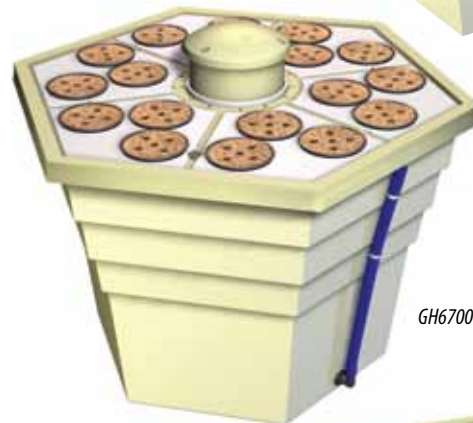

GH6700

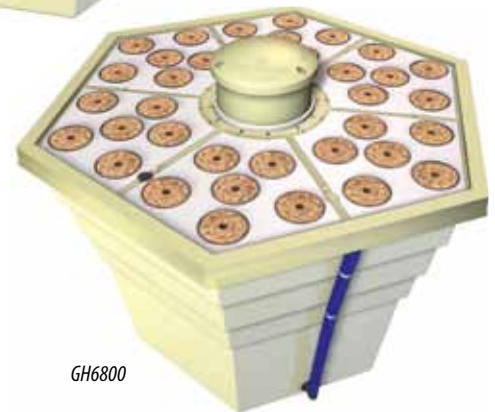

GH6800

ITEM CODE	DESCRIPTION	SRP
GH6700	RainForest Modular 318 – Vortex Sprayer	\$295.17
GH6800	RainForest Modular 236 – Vortex Sprayer	291.50
GH6600	RainForest Modular 66 – Vortex Sprayer	291.50
GH6610	RainForest Modular 66 Lid Insert Kit– Six 6" Lid Inserts, 6 - 6" Grow Cups	71.25
GH6710	RainForest Modular 318 Lid Insert Kit– Six 3" Lid Inserts, 18 - 3" Grow Cups	75.00
GH6810	RainForest Modular 236 Lid Insert Kit– Six 2" Lid Inserts, 36 - 2" Grow Cups	72.50



AEROFLO® AEROPONICS

By generating a fine mist of nutrient solution, AeroFlo Aeroponics systems optimize the oxygen/water/nutrient ratio for plant roots and provide ideal conditions for all stages of growth. Plants' roots grow in the moist air space between the net cups and hang in a shallow, constantly circulating bath of super-oxygenated nutrient solution. Systems come with everything you need to get started – net cups, coco inserts, pump, all plumbing and fittings, leg stand, and nutrient solution.

AEROFLO® 18 AEROPONICS

GH8006 – With a 17-gallon reservoir and 18 plant sites, the AeroFlo 18 site is perfect for those who want a compact, high performance system. It is particularly well-suited to growing lettuce, basil, and other small plants up to three feet in height.

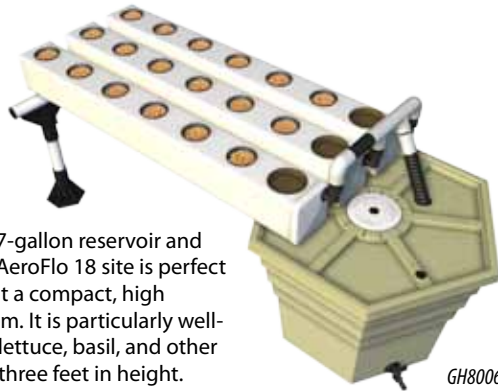

AEROFLO2® 20 AEROPONICS

GH8000 – A twenty site system and an excellent choice for growing small crops such as lettuce, cucumbers, peppers, basil, and other herbs. Varieties of flowers and tomatoes, which do not grow taller than three feet, will also do well. Works beautifully when placed near a sunny window in your home or office.

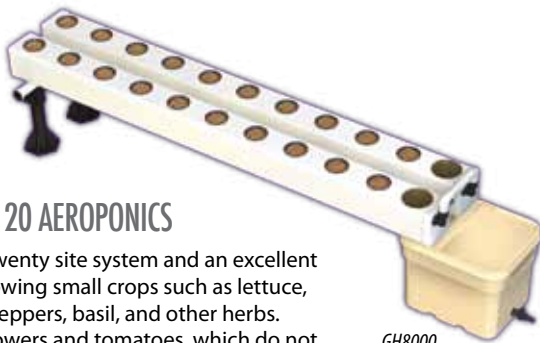

AEROFLO® 30 AEROPONICS

GH8008 – With a 20-gallon reservoir and thirty plant sites, the three grow chambers can be kept side-by-side or fanned out in a radial pattern to maximize growth on lower branches. A perfect system for those who want a smaller, high performance system. Excellent for growing lettuce, basil, and other smaller plants up to 4' in height.

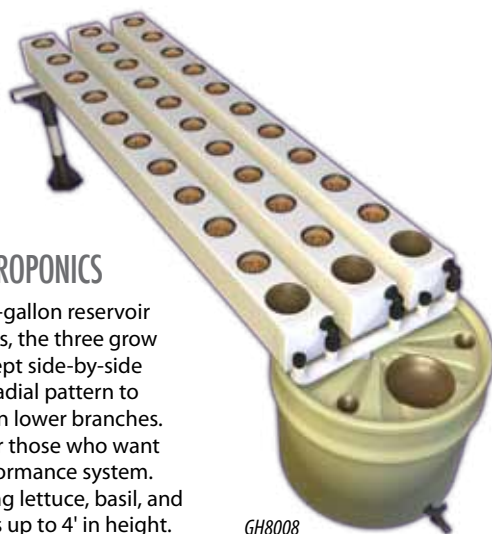

AEROFLO2® 36 AEROPONICS

GH8004 – Designed specifically for indoor cultivation under a grow light, the AF236 system offers 36 plant sites in a compact footprint. It also features the generous 40-gallon Panda reservoir.



AEROFLO2® 60/120 AEROPONICS

GH8002 – Our largest AeroFlo2 unit, the AF260, features sixty plant sites. Growers who wish to expand this system can enjoy a total of 120 plant sites with the addition of our AeroFlo2 60 extension unit. Users can choose either to configure the grow chambers on the same side or to stagger them in order to cover a larger area or to grow larger plants. The AF260 and extension unit feature the generous 40-gallon Panda reservoir.



ITEM CODE	DESCRIPTION	SRP
GH8006	AeroFlo – 18 Site 2' x 5'2"	\$429.00
GH8000	AeroFlo2 – 20 Site 1" x 7" (2Bx)	\$421.67
GH8008	AeroFlo – 30 Sites (2' x 7'), 20 Gal. Res, 3–6 ft. chambers	\$559.98
GH8004	AeroFlo2 – 36 Sites (3' x 4'), 40 Gal. Res, 6–4 ft. chambers	\$937.74
GH8002	AeroFlo2 – 60 Sites (6' x 6'), 35 gal Res, 6–6 ft chambers	\$1173.33
GH8003	AeroFlo2 – 60 Sites Extension (120 Sites) (5' x 6')	935.00
GH8023	AeroFlo2 – 60 Manifold	70.00
GH98001	AeroFlo2 – 6 ft.Sq. Chamber- Drilled on 7" Centers for 3" Net Cups	\$98.08

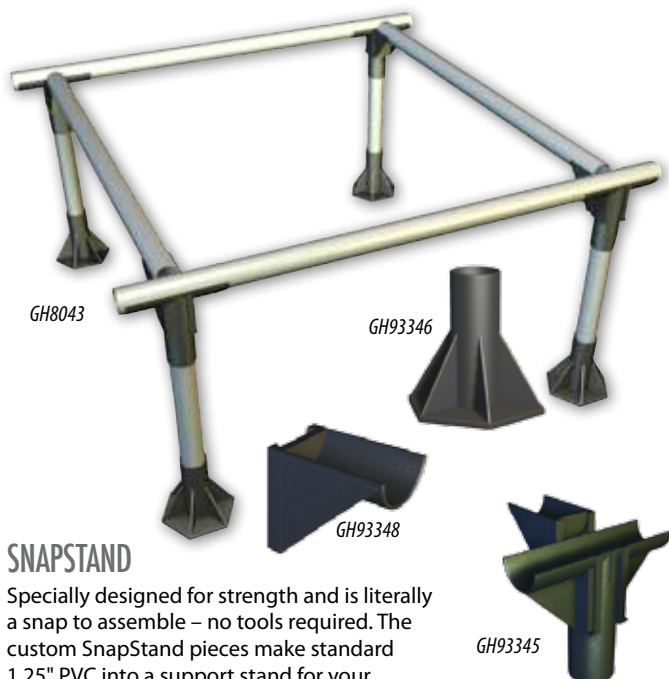

SNAPSTAND

Specially designed for strength and is literally a snap to assemble – no tools required. The custom SnapStand pieces make standard 1.25" PVC into a support stand for your system or as many uses as the grower's imagination can conceive.

ITEM CODE	DESCRIPTION	SRP
GH8043	SnapStand 4' x 4' Tray Stand	\$90.00
GH93345	SnapStand Cross Fitting	4.79
GH93346	SnapStand Foot Base	4.79
GH93348	SnapStand Dovetail 90°	3.79

PANDA RESERVOIR

The 40-gallon Panda reservoir has a white exterior to reflect light and heat and is black on the inside to discourage algae growth. Its sleek design fits into tighter spots to optimize space. Convenient access hatch makes nutrient changes a breeze. Float valves and drain kits are also available.



ITEM CODE	DESCRIPTION	SRP
GH93351	Panda Reservoir w/out Lid, 40 Gal	142.00
GH93380	Panda Reservoir Lid w/no holes, 40 Gal	92.00

CONTROLLER SYSTEM

A container with a float valve connected to the line of units. A master reservoir filled with fresh water and nutrients is located on top of the float-valve activated controller. As the plants draw water from their individual reservoirs, the liquid levels drop, causing the float valve in the controller to open and draw fresh nutrients from the master reservoir. This automatically maintains the ideal nutrient level in all the interconnected units. Simple, elegant, reliable, and inexpensive.



Dimensions:
3'6"H x 12"W x 12"L

- Controller includes:**
- 13-gallon reservoir with grommet
 - 8-gallon controller with float valve fittings
 - Seven .5" barbed tees
 - Blue .5" tubing
 - Two .5" elbows

ITEM CODE	DESCRIPTION	SRP
GH4520	Controller System (accommodates 8 Farm Modules)	\$134.36

TEXAS CONTROLLER Unit

includes a 20-gallon reservoir with grommet, 20-gallon controller with float valve, fittings, fifteen .5" barbed tees, .5" tubing, and two .5" elbows. Dimensions: 3' 6"H x 2'W x 2'L



ITEM CODE	DESCRIPTION	SRP
GH4610	Texas Controller (accommodates 16 Farm Modules)	\$372.00

COVERT TANK

Covert Tanks are portable, lightweight and are ideal for use as a hydroponic barrel, or for water storage. Covert Tanks are collapsible and are extremely compact which makes them ideal for moving and set up in small spaces and covert ops. Made with food grade plastic.



ITEM CODE	DESCRIPTION	SRP
GH3502	Covert Tank 66 gal/250 L	\$65.30



CLONE MACHINE

Botanicare designed these clone machines to be cost efficient and practical. Each machine contains a true aeroponic mist application to ensure the best rooting and aeration to achieve optimum results.



ITEM CODE	DESCRIPTION	SRP
BCHSCL25	25 Plant Clone Machine	\$171.95
BCHSCL48	48 Plant Clone Machine	249.95

AEROJET AEROPONICS HYDROGARDEN

The Aerojet is Botanicare's best selling expandable hydrogarden. It is a true aeroponic system, not a deep flow hydro-aeroponic system. Microjets spray the roots of the plants allowing for aggressive growth rates due to the high levels of oxygen delivered to the root zone. Ideal for hobbyists, schools, research and education, and preferred by advanced growers as the method of choice in feed delivery methods.



ITEM CODE	DESCRIPTION	SRP
BCHSAJ2	2 Tray Aerojet	\$802.50
BCHSAJ4	4 Tray Aerojet	1069.95
BCHSAJ6	6 Tray Aerojet	1209.50
BCHSAJ8	8 Tray Aerojet	1,711.95

MICROGARDEN

A multi-method hydrogarden perfect for propagating plants or nourishing and watering seedlings. It holds a 1020 seeding tray containing (72) 1.5" starter plugs or (200) 3/4" plugs.



ITEM CODE	DESCRIPTION	SRP
BCMGEF	Micro Garden Ebb & Flow 14" x 30"	\$258.95
BCMGRIP	Micro Garden Drip 14" x 30"	263.95
BCHSMGAERO	Micro Garden Aeroponic with Lid	358.95
BCMDRIPLINE	.125" Dripline with Stakes	0.75



DAISY CLONER

The aeroponic Daisy Cloner is a self-contained cloning system that fits almost anywhere. Its high-pressure mist provides a perfect atmosphere for fast root development. Comes with net cups and lids, and a 120-volt, UL-listed submersible pump with one-year warranty. Reservoir holds approximately three gallons. The Daisy Cloner 8 has 2-inch plant sites. The Daisy Cloner 4 has 3-inch plant sites and a larger plant area, perfect for growing smaller sized plants (peppers, ornamentals, cooking herbs) to maturity.



Not shown to scale

ITEM CODE	DESCRIPTION	SRP
BCHSDAISY8	Daisy Cloner, 8 Site	84.95

TURBOGARDEN

The same features as above, but has a larger reservoir and holds more plants. Rapid growth rates, higher yields, increased nutritional value, heightened fragrances and flavors in a 2' x 3' area!



ITEM CODE	DESCRIPTION	SRP
BCTGEF	Turbo Garden Ebb & Flow	\$366.25
BCHSTGDRIPI	Turbo Garden Drip	378.95
BCHSTGAERO	Turbo Garden Aeroponic w/Lid	551.95

NEOPRENE INSERTS

Custom made neoprene collars are pre-slit for easy insertion of cuttings.



360° CLONE SPINNER & AEROPONIC MISTER



ITEM CODE	DESCRIPTION	SRP
BCPTNEO2	Botanicare Neoprene Insert, 2" – 25/pk	\$14.50
BCPTNEO3.75	Botanicare Neoprene Insert, 3.75" – 25/pk	35.28
BCPTNEO5	Botanicare Neoprene Insert, 5" – 25/pk	50.40
BCPTNEOPC	Botanicare Neoprene Insert for Power Clone, 1.625" – 25/pk	13.95
BCCLSPIN	360 Degree Clone Spinner	\$1.45
BCFTSPRAY180	180 Aeroponic Mister, 50/pk	\$14.75
BCFTSPRAY330	360 Aeroponic Mister, 50/pk	14.75



POWER CLONER

Botanicare Powers Cloners underwent a series of improvements and modifications to provide gardens of all sizes consistent, reliable production. Redeveloped with a Botanicare low profile reservoir, these systems decrease propagation time.

- Unique Botanicare cord guide designed to block sprayed solution & improve cord management
- Drainage grid with a recessed pump
- An internally seated tray
- Humidome™ options
- Customizable points for installation of spouts and fittings
- Botanicare ceramic airstones with air pump
- Water volume indicator
- Dense neoprenes



BCHSCLPCBA45



BCHSCLPCWA45



BCHSCLPCWB77



BCHSCLPCBB77

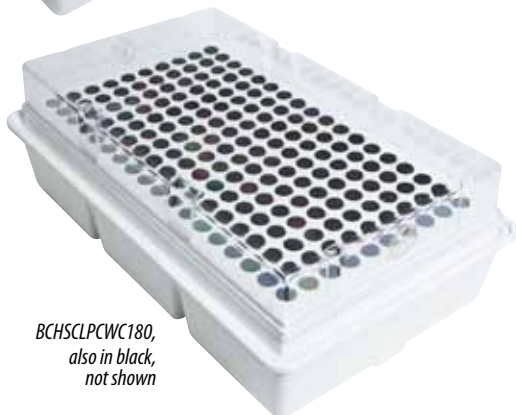

BCHSCLPCWC180,
also in black,
not shown

ITEM CODE	DESCRIPTION	SRP
BCHSCLPCBA45	Power Cloner 45, Black	\$299.95
BCHSCLPCBB77	Power Cloner 77, Black	379.95
BCHSCLPCBC180	Power Cloner 180, Black (not shown)	581.50
BCHSCLPCWA45	Power Cloner 45, White w/dome	\$363.25
BCHSCLPCWB77	Power Cloner 77, White w/dome	474.95
BCHSCLPCWC180	Power Cloner 180, White w/dome	737.00

White Cloners also include AquaShield and ZHO.



**100%
recyclable!**



EZ-CLONE CLASSIC CUTTING SYSTEM

The new EZ-CLONE Classic Cutting System is made from fully recyclable HDPE which is highly chemically resistant and extremely durable. Leak resistant cord outlet allows multiple cords. Recessed drain is highly protected and lets you easily tip the unit for draining.

EZ-CLONE CLONING COLLARS & NEOPRENE INSERTS

Cloning collars and neoprene inserts are custom cut to fit the EZ-CLONE Classic Cutting System.



ITEM CODE	DESCRIPTION	SRP
EZCL16	EZ-Clone Classic 16 Cutting System	\$159.95
EZCL32	EZ-Clone Classic 32 Cutting System	249.95
EZCL64	EZ-Clone Classic 64 Cutting System	319.95
EZCL128	EZ-Clone Classic 128 Cutting System	419.95
EZCOL175	EZ Clone Soft Cloning Collars, 17 ct	\$9.95
EZCOL355	EZ Clone Soft Cloning Collars, 35 ct	15.75
EZCOL655	EZ Clone Soft Cloning Collars, 65 ct	29.25
EZCOL35H	EZ Clone Hard Cloning Collars, 35 ct	\$15.75
EZCOL65H	EZ Clone Hard Cloning Collars, 65 ct	29.95



Includes everything to start growing right out of the box!

THE AEROGARDEN is a complete countertop hydroponic garden that produces an abundance of fresh herbs, flowers, vegetables, salad greens, and more indoors and year-round. Using aeroponic technology, your plants grow in water, nutrient, and oxygenated air to directly deliver nourishment to their roots. The AeroGarden makes indoor gardening easy, with no dirt, no weeds, and no mess.

EASY – Drop in the pre-seeded Grow Pods, add water and grow. Plant your own seeds or choose from a wide variety of pre-seeded kits.

AUTOMATED – Reminds you when to add nutrients. Light turns on and off automatically.

VERSATILE – Grow a wide variety of herbs, vegetables, salad greens, flowers and more!

FOOLPROOF – 100% success guaranteed!



AEROGARDEN 7 is fully automated, elegantly designed, and now available in silver as well as in classic black. Grow beautiful plants indoors, any time of year – from tomatoes to fresh herbs, lettuce, flowers, and more!



AEROGARDEN 3 is stylish and space saving – about the same size as a coffee maker! Perfect for kitchens that are short on counter space.

AEROGARDEN ULTRA is a revolutionary new indoor garden, featuring the MyGarden control panel – the "brain" of the garden that guides you every step of the way, from planting to harvest. With twice the light of the Aerogarden 7, and more than twice the height, the Aerogarden Ultra is great for growing bigger plants better. Still perfect for herbs and lettuce, too!

- MaxGrow Grow Lights for even greater luminosity
- Loads of smart features including "Quick Plant" settings, on-screen clock, "Garden Coach" that displays growing tips, easy to set 24 hour light cycles, reminder system with audio alerts, detailed dashboard notes, and custom settings for all critical garden functions including lights, nutrient cycle, and pump cycle
- Improved lamp hood, reflectors and lamp arm for greater growth, easier adjustment

SIZE: 33.5"H x 14.75"W x 19.25"D

SIZE: 21"H x 18.5"W x 10.5"D

SIZE: 20"H x 9.5"W x 11"D

2-PACK GROW LIGHTS

These energy efficient grow lights were engineered exclusively for all AeroGardens with 1 and 2 lights in the hood. High output, full spectrum grow lights provide the optimal amount and type of light needed for robust growth.



Available in 3 sizes!



	AEROGARDEN ULTRA	AEROGARDEN 7	AEROGARDEN 3
Item Code	AERO604	AERO500/500S	AERO300
POD CAPACITY:	7	7	3
Grow Lights	3	2	1
Gourmet Seed Kit	1	1	1
Grow Anything Seed Kit	1	1	
MyGarden Control Panel	1		
Trellis System	1		

ITEM CODE	DESCRIPTION	SRP
AERO604	AeroGarden ULTRA – includes Grow Anything Kit and Gourmet Herb Seed Kit	\$249.95
AERO500	AeroGarden 7 Complete Kit – includes Grow Anything Kit and Gourmet Herb Seed Kit	159.95
AERO500S	AeroGarden 7 (Silver) – Includes Grow Anything Kit and Gourmet Herb Seed Kit	159.95
AERO300	AeroGarden 3 (Black) with Gourmet Seed Kit	79.95
AERO505	Grow Lights for All 1- and 2-Light Gardens, 2/pk	\$24.95

AeroGarden®

SEED KITS

GROW ANYTHING 1-SEASON KIT

Grow Anything Kits let you plant and grow your own favorite seeds in the AeroGarden, from snap peas to wildflowers and more. Or easily root cuttings from your favorite plants.

- 7 grow sponges (seeds not included)
- Liquid nutrients
- (9) 8 ml packets for growing herbs/flowers/salad greens
- (16) 5.5 ml packets for growing vegetables and larger plants
- 7 universal baskets for easy transplanting
- 7 grow domes for faster germination
- 7 labels



GOURMET HERB SEED KIT

Begin harvesting in three to four weeks and continue harvesting for four to five months. Includes Genovese basil, dill, thyme, lemon basil, mint, oregano, and globe basil.

Available exclusively as part of the AeroGarden 7 Complete Kit.

CHERRY TOMATO SEED KIT

Ready to harvest in ten to twelve weeks and continues producing fruit for up to six months. Includes three red heirloom cherry tomato seed pods, plus 4 plant spacers.



CHILI PEPPER SEED KIT

Harvestable fruit in about twelve weeks with hundreds of peppers produced for up to six months. Includes 2 mildly spicy jalapeños, 2 medium Red Fire, and 3 tiny, fiery Super Hots.



FRESH TEA SEED KIT

Makes tea a delicious, special treat—cut fresh from the plant and steep your own special blend, or add amazing flavor to your favorite green or black tea. Includes lavender, peppermint, lemon balm, and lemon mint.



GOLDEN HARVEST CHERRY TOMATO SEED KIT

Bright yellow with a very sweet flavor. Ready to harvest in ten to twelve weeks and continues producing fruit for up to six months. Includes 3 Golden Harvest cherry tomato seed pods and 4 plant spacers.



JALAPEÑO PEPPER SEED KIT

Grow delicious jalapeño peppers all year long! Includes 1 jalapeño pepper seed pod and 2 plant spacers to give your plant ample room to grow.



MIXED ROMAINE SEED KIT

A mixture of crispy, sweet, red and green leaf romaine varieties. Begin harvesting in three to four weeks and enjoy continuous harvests for up to four months.



PESTO BASIL SEED KIT

The favorite basil of Italy, Genovese basil is perfect for pesto. AeroGarden's most productive herb kit will make all the pesto your heart desires.



SALAD GREENS SEED KIT

Perfect for making salads, adding to sandwiches, or garnishing meals. Begin harvesting in weeks and enjoy continuous harvests for three to four months. Includes seeds for green leaf, red leaf, butterhead, and romaine.



SALSA GARDEN SEED KIT

Begin harvesting in ten to twelve weeks and then continuously for up to six months. Includes 2 cherry tomato seed pods, 1 jalapeño seed pod, and 4 plant spacers to allow ample room for the plants to flourish and thrive.



THAI PEPPER SEED KIT

Spicy little bright red peppers produced abundantly on lush plants. Includes 3 Thai pepper seed pods and 4 spacers to allow your pepper plants ample room to flourish and thrive.



ITEM CODE	DESCRIPTION	SRP
AER0501	Cherry Tomato Seed Kit	\$19.95
AER0509	Chili Pepper Seed Kit	19.95
AER0602	Fresh Tea Seed Kit	19.95
AER0506	Golden Harvest Cherry Tomato Seed Kit	19.95
AER0503	Grow Anything 1-Season Kit	19.95
AER0507	Jalapeño Pepper Seed Kit	19.95
AER0603	Mixed Romaine Seed Kit	19.95
AER0504	Pesto Basil Seed Kit	19.95
AER0502	Salad Greens Seed Kit	19.95
AER0601	Salsa Garden Seed Kit	19.95
AER0508	Thai Pepper Seed Kit	19.95

LAZY GARDENER SELF-WATERING INSERT

Never over-water again with this innovative self-watering system. Lazy Gardener creates ideal growing conditions by maintaining consistent moisture content, root zone temperature, and oxygen levels. Instead of water, it delivers water vapor, which is the most efficient form of irrigation, eliminates over watering, and cuts water use by up to 90%. All you need to supply is power and a water reservoir (sold separately).

- Three sizes
- Root-zone warming
- Longer growing season and higher yields
- Root-zone aeration
- No fungal root diseases

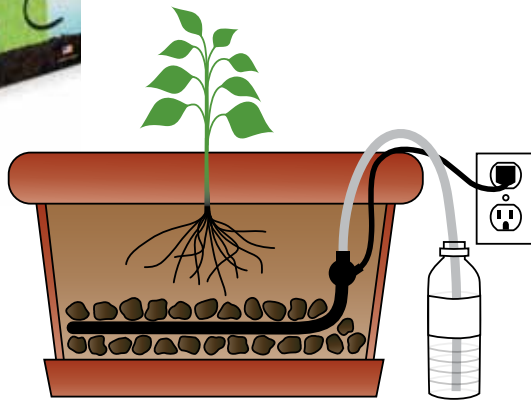

MOISTURE DELIVERY WICK Uses up to 10 times less water, yet still provides a constant, controlled moisture vapor to the root system for perfect root zone hydration.

WATER SUPPLY LINE The water supply line with the moisture delivery wick and heating element have been carefully scaled to prevent swamping the root system.

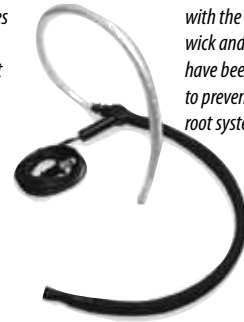

THERMOSTATIC HEATING ELEMENT Sipping just 7 watts of electricity, it maintains an optimal sub-surface temperature to extend the growing season by months while also facilitating rapid, robust and healthy root development.

ITEM CODE	DESCRIPTION	SRP
AG3417	Lazy Gardener Self-Watering Insert, 1"–12"	\$19.99
AG3418	Lazy Gardener Self-Watering Insert, 14"–22"	24.99
AG3419	Lazy Gardener Self-Watering Insert, Raised Bed, 9–12 sq. ft	39.99

PHANTOM DE



Our new Phantom DE Reflector and Ballast make the most of your double-ended 1000W lamps.



Phantom DE Ballast
See page 37



Phantom DE Reflector
See page 23