

For the latest product and pricing updates for this category, scan the QR code or go to Hydrofarm.com.



HYDROPONICS

293–318

Active Aqua Premium High Rise Flood Tables	296
Low Rise Flood Tables	297
Active Aqua Low Rise Flood Tables	297
Black Flood Tables	298
Active Aqua White Flood Tables	298
Economy Flood Tables	299
Active Aqua Fill/Drain Fittings	299
Active Aqua Fill/Drain Combo Kit	299
Active Aqua Premium White Reservoirs & Covers	300
Premium Reservoir Cover & Porthole Cover	300
Premium Reservoir Kits	300
Reservoirs, Covers & Ports	301
Active Aqua Tray Stands	302
Root Spa Complete Deep Water Culture System	303
Root Spa	303
Emily's Garden™ System	304
MegaGarden™ System	304
Tomato Planters	305
Grow Flow Ebb & Flow System	306–307
55 Gallon Reservoir Drum	307
Ebb & Gro Hydro System and Components	308
The Ebb Monster 6 Pot System	308
Neoprene Inserts	309
PLANT!T Big Float Auto Top-Up Kit	309
Telescopic Flood Table Groove Brush	309
Drill Bit for Drain Installations & Deburring Tool	309
Floating Thermometer	309
Waterfarm®	310
Powergrower Eco	310
Ecogrower Max & Megafarm	311
Eurogrower Drip Hydroponics	311
Rainforest Aeroponics	311
Aeroflo® Aeroponics	312
Panda Reservoir	313
Controller System	313
Clone Machine	314
Daisy Cloner	314
Neoprene Inserts	314
360° Clone Spinner & Aeroponic Mister	314
Power Cloner	314
EZ-Clone Classic Cutting System & Collars	315
Aerogarden & Seed Kits	316–317
Autopot Watering Systems	318
Easy2go Kit	318
Flexitank	318

ActiveAQUA
HYDRO CULTURE

Durable
hydroponics
solutions for
dedicated
indoor
gardeners

(pgs 296-303)



HYDR FARM



STRONG · DURABLE · LOW MAINTENANCE

Active Aqua is our extensive line of custom designed and engineered hydroponic growing tools and accessories that offer superior performance and unsurpassed value.

ACTIVEAQUA™ FLOOD TABLE SPECIFICATIONS CHART

IMAGE	ITEM CODE	DESCRIPTION	WT	VOLUME	INSIDE DIMENSIONS	OUTSIDE DIMENSIONS
	AAHR22W	Active Aqua Premium High Rise Flood Table, 2' x 2'	3 lbs.	15 gal	24" x 24" x 7"	28½" x 28½" x 8½"
	AAHR24W	Active Aqua Premium High Rise Flood Table, 2' x 4'	13 lbs.	30 gal	48" x 24" x 7"	52½" x 28½" x 8½"
	AAHR33W	Active Aqua Premium High Rise Flood Table, 3' x 3'	14 lbs.	36 gal	36" x 36" x 7"	40½" x 40½" x 8½"
	AAHR44W	Active Aqua Premium High Rise Flood Table, 4' x 4'	24 lbs.	60 gal	48" x 48" x 7"	52½" x 52½" x 8½"
	AAHR36W	Active Aqua Premium High Rise Flood Table, 3' x 6'	27 lbs.	72 gal	72" x 36" x 7"	76½" x 40½" x 8½"
	AAHR84W	Active Aqua Premium High Rise Flood Table, 4' x 8'	46 lbs.	120 gal	96" x 48" x 7"	100½" x 52½" x 8½"
	AAWT2245T	Active Aqua Premium High Rise Flood Table for Tents, 22" x 45"	6 lbs.	18 gal	42" x 19" x 6"	45" x 22" x 7"
	AALR24B	2' x 4' Flood Table, black	5 lbs.	13.5 gal	46¼" x 22¼" x 3⅛"	48" x 24" x 3¾"
	AALR33B	3' x 3' Flood Table, black	10 lbs.	15 gal	34¼" x 34¼" x 3⅛"	36" x 36" x 3¾"
	AALR44B	4' x 4' Flood Table, black	12 lbs.	28 gal	46¼" x 46¼" x 3⅛"	48" x 48" x 3¾"
	AALR84B	8' x 4' Flood Table, black	20 lbs.	57 gal	94¼" x 46¼" x 3⅛"	96" x 48" x 3¾"
	HGFTW24	Active Aqua 2' x 4' Flood Table, white	8 lbs.	20 gal	48" x 24" x 5"	29½" x 53¾" x 7"
	HGFTW44	Active Aqua 4' x 4' Flood Table, white	15 lbs.	40 gal	48" x 48" x 5"	53½" x 53½" x 7"
	HGFTW84	Active Aqua 8' x 4' Flood Table, white	25 lbs.	80 gal	96" x 48" x 5"	53½" x 101¼" x 7"
	HGFT22	2' x 2' Flood Table, black	5 lbs.	10 gal	24" x 24" x 5"	29¾" x 29¾" x 7"
	HGFT24	2' x 4' Flood Table, black	8 lbs.	20 gal	48" x 24" x 5"	53.5" x 29¾" x 7"
	HGFT33	3' x 3' Flood Table, black	9 lbs.	24 gal	36" x 36" x 5"	41" x 41" x 7"
	HGFT44	4' x 4' Flood Table, black	13 lbs.	40 gal	48" x 48" x 5"	53½" x 53½" x 7"
	HGFT46	4' x 6' Flood Table, black	25 lbs.	60 gal	72" x 48" x 5"	77" x 53" x 7"
	HGFT36	3' x 6' Flood Table, black	20 lbs.	48 gal	72" x 36" x 5"	77" x 41" x 7"
	HGFT84	8' x 4' Flood Table, black	25 lbs.	80 gal	96" x 48" x 5"	101¼" x 53½" x 7"
	HGFE24	2'x 4' Economy Flood Table	5 lbs.	10 gal	40" x 16½" x 4"	2" x 47" x 5"
	HGFE44	4'x 4' Economy Flood Table	12 lbs.	20 gal	40" x 40" x 4"	47" x 47" x 5½"
	HGFE84	8'x 4' Economy Flood Table	20 lbs.	40 gal	87" x 40" x 4"	46½" x 93¾" x 5½"

ACTIVE AQUA PREMIUM HIGH RISE FLOOD TABLES

Active Aqua's Premium High Rise Flood Tables offer unparalleled strength and performance. These heavy duty full ID flood tables are thick, rigid, durable, and easy to clean. The edges are arch-formed, which reinforces the flood table and minimizes flexing. They feature a square drainage pattern and smooth channels, which simplifies cleaning. Active Aqua's Premium High Rise Flood Tables are manufactured in seven sizes: 2'x2', 2'x4', 2'x4' tent, 3'x3', 4'x4', 3'x6', 4'x8'.

- Made in North America
- UV-resistant, virgin ABS plastic cap over a 100% recycled ABS plastic core
- True internal dimensions
- Water level fill height indicators
- Reinforced with a deep, 7" sidewall
- Recessed drain position
- Smooth, rounded corners
- Easy to clean

100% Recyclable!

Strong, durable, and low maintenance

Thick, durable walls and corners!

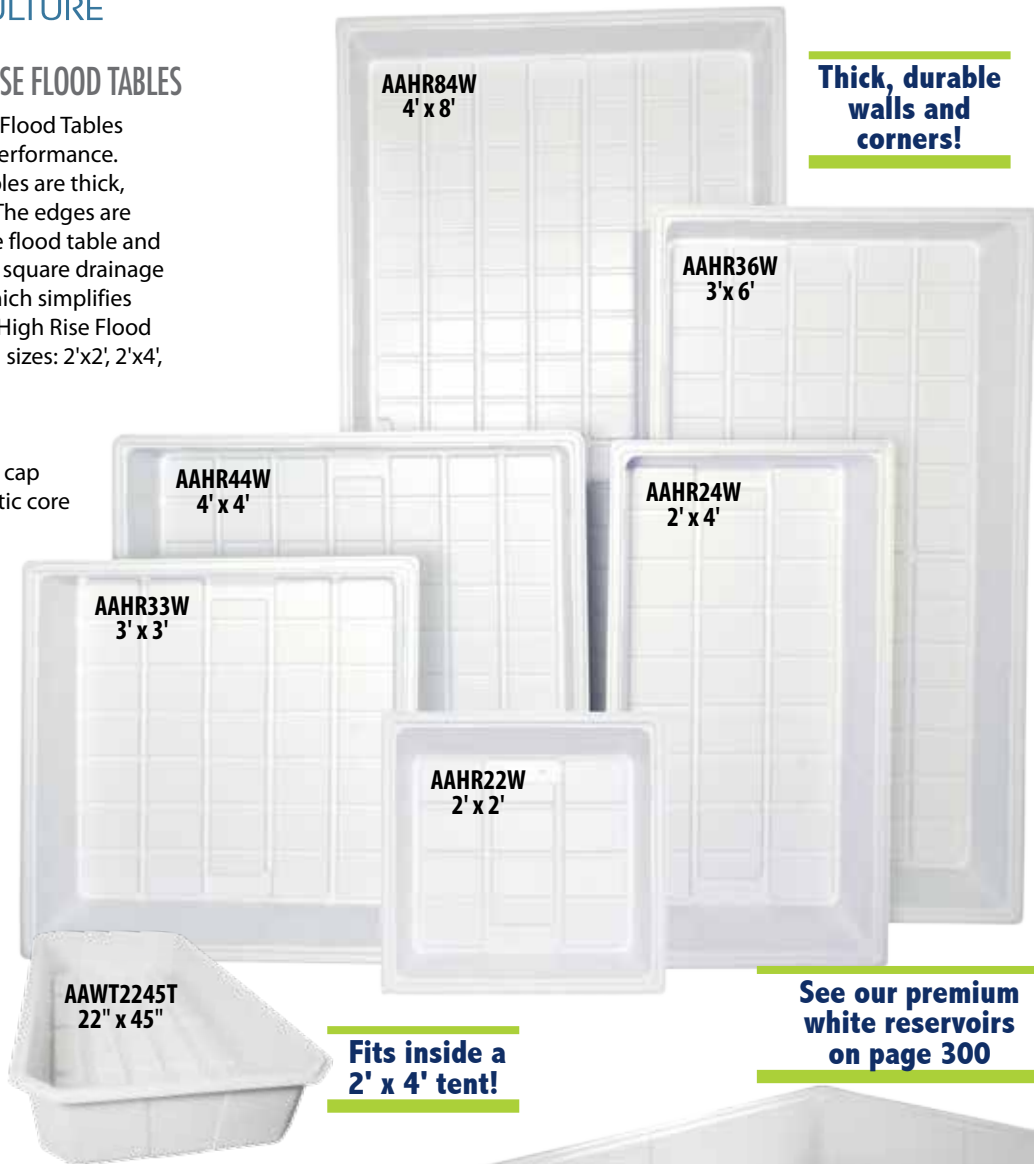

See our premium white reservoirs on page 300

Fits inside a 2' x 4' tent!



Recessed drain position for better drainage



Arch-formed edge for more strength



Inside gradation for accurate water levels



ITEM CODE	DESCRIPTION	WT	VOLUME	INSIDE DIMENSIONS	OUTSIDE DIMENSIONS	THICKNESS	SRP
AAHR22W	Active Aqua Premium High Rise Flood Table, 2' x 2'	3 lbs.	15 gal	24" x 24" x 7"	28.5" x 28.5" x 8.5"	0.22"	\$59.59
AAHR24W	Active Aqua Premium High Rise Flood Table, 2' x 4'	13 lbs.	30 gal	48" x 24" x 7"	52.5" x 28.5" x 8.5"	0.22"	81.95
AAHR33W	Active Aqua Premium High Rise Flood Table, 3' x 3'	14 lbs.	36 gal	36" x 36" x 7"	40.5" x 40.5" x 8.5"	0.23"	115.95
AAHR36W	Active Aqua Premium High Rise Flood Table, 3' x 6'	27 lbs.	72 gal	72" x 36" x 7"	76.5" x 40.5" x 8.5"	0.23"	187.95
AAHR44W	Active Aqua Premium High Rise Flood Table, 4' x 4'	24 lbs.	60 gal	48" x 48" x 7"	52.5" x 52.5" x 8.5"	0.24"	147.95
AAHR84W	Active Aqua Premium High Rise Flood Table, 4' x 8'	46 lbs.	120 gal	96" x 48" x 7"	100.5" x 52.5" x 8.5"	0.24"	279.95
AAWT2245T	Active Aqua Premium High Rise Flood Table for Tents, 22" x 45"	6 lbs.	18 gal	42" x 19" x 6"	45" x 22" x 7"	0.175"	\$69.95



STRONG · DURABLE · LOW MAINTENANCE

**ACTIVE AQUA PREMIUM
LOW RISE FLOOD TABLES**

Active Aqua Low Rise Flood Tables feature curved narrow edges that allow for tighter grow space, and vertical channels that slope toward the center of the table, directing water to drain down horizontal channels. Ideally suited for top feeding, and perfect for catching run-off from your hydroponic setup. Available in black only, in our four most popular sizes – 2'x4', 3'x3', 4'x4', and 4'x8'.

Low profile and narrow edges provide a better fit for tighter grow spaces



Unique grid design allows for fast and thorough drainage

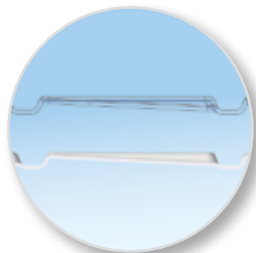

Sloped grid drains each channel to center of tray

Durable, rigid and strong with low profile 3/4" sidewall



ACTIVE AQUA LOW RISE FLOOD TABLES

ITEM CODE	DESCRIPTION	WT	VOLUME	INSIDE DIMENSIONS	OUTSIDE DIMENSIONS	SRP
AALR24B	2'x4' Low Rise Flood Table, black	9 lbs.	13.5 gal	46.25" x 22.25" x 3.125"	48" x 24" x 3.75"	\$49.95
AALR33B	3'x3' Low Rise Flood Table, black	9 lbs.	15 gal	34.25" x 34.25" x 3.125"	36" x 36" x 3.75"	54.95
AALR44B	4'x4' Low Rise Flood Table, black	9 lbs.	28 gal	46.25" x 46.25" x 3.125"	48" x 48" x 3.75"	79.95
AALR84B	8'x4' Low Rise Flood Table, black	25 lbs.	57 gal	94.25" x 46.25" x 3.125"	96" x 48" x 3.75"	154.95



ACTIVE AQUA BLACK FLOOD TABLES

Active Aqua flood tables offer features that rival the competition at value prices. Made from durable, high-impact ABS plastic with UV resistance for longevity, with true, full-size dimensions and volume to provide maximum growing area.



Inside gradation for accurate water levels

Superior grid pattern to promote fast and thorough drainage



HGFT36
3' x 6'



HGFT33
3' x 3'

Rounded corners for easy cleaning



HGFT24
2' x 4'



HGFT44
4' x 4'



ITEM CODE	DESCRIPTION	WT	VOLUME	INSIDE DIMENSIONS	OUTSIDE DIMENSIONS	SRP
HGFT22	2' x 2' Flood Table, black	5 lbs.	10 gal	24" x 24" x 5"	29.75" x 29.75" x 7"	\$39.95
HGFT24	2' x 4' Flood Table, black	8 lbs.	20 gal	48" x 24" x 5"	53.5" x 29.75" x 7"	61.95
HGFT33	3' x 3' Flood Table, black	9 lbs.	24 gal	36" x 36" x 5"	41" x 41" x 7"	67.95
HGFT44	4' x 4' Flood Table, black	13 lbs.	40 gal	48" x 48" x 5"	53.5" x 53.5" x 7"	97.95
HGFT46	4' x 6' Flood Table, black	25 lbs.	60 gal	72" x 48" x 5"	77" x 53" x 7"	157.95
HGFT36	3' x 6' Flood Table, black	20 lbs.	48 gal	72" x 36" x 5"	77" x 41" x 7"	129.95
HGFT84	8' x 4' Flood Table, black	25 lbs.	80 gal	96" x 48" x 5"	101.25" x 53.5" x 7"	185.95

ACTIVE AQUA WHITE FLOOD TABLES

Now our Active Aqua flood tables are available in white in three popular sizes – 2' x 4', 4' x 4' and 8' x 4'. All Active Aqua flood tables feature stronger corners and thicker walls than any others in their class, with multi-drain positions for versatility in setups and rounded corners for easy cleaning.



HGFTW24
2' x 4'



HGFTW44
4' x 4'

Now available in white!

Rounded corners for easy cleaning



Inside gradation for accurate water levels



HGFTW84
8' x 4'

Superior grid pattern design and multi-level drainage channels to promote fast and thorough drainage

True full size dimensions & volume

ITEM CODE	DESCRIPTION	WT	VOLUME	INSIDE DIMENSIONS	OUTSIDE DIMENSIONS	SRP
HGFTW24	Active Aqua 2' x 4' Flood Table, white	8 lbs.	20 gal	24" x 48" x 5"	29.5" x 53.75" x 7"	\$61.95
HGFTW44	Active Aqua 4' x 4' Flood Table, white	15 lbs.	40 gal	48" x 48" x 5"	53.5" x 53.5" x 7"	97.95
HGFTW84	Active Aqua 8' x 4' Flood Table, white	25 lbs.	80 gal	48" x 96" x 5"	53.5" x 101.25" x 7"	185.95





ACTIVE AQUA ECONOMY FLOOD TABLES

Our economy flood tables have the same grid pattern, drainage channels, depth charts and dimensions as our Active Aqua tables – at a lighter weight and an even lower price!



HGfTE24
2' x 4'



HGfTE84
8' x 4'



HGfTE44
4' x 4'



Great value!

ITEM CODE	DESCRIPTION	WT	VOLUME	INSIDE DIMENSIONS	OUTSIDE DIMENSIONS	SRP
HGfTE24	2' x 4' Economy Flood Table	5 lbs.	10 gal	16.5" x 40" x 4"	2" x 47" x 5"	\$59.95
HGfTE44	4' x 4' Economy Flood Table	12 lbs.	20 gal	40" x 40" x 4"	47" x 47" x 5.5"	84.95
HGfTE84	8' x 4' Economy Flood Table	20 lbs.	40 gal	40" x 87" x 4"	46.5" x 93.75" x 5.5"	136.95



ACTIVE AQUA FILL/ DRAIN FITTINGS

These fittings are mostly used for ebb & flow and drip systems. An ebb & flow system pumps the water from your reservoir up to your flood table. When the water level gets to the level of the overflow fitting, it spills back into the reservoir from the overflow fitting. A drip system simply uses a Fill/Drain fitting to drain the water back to your reservoir from the flood table. The fittings accept 1/2", 3/4", or 1" tubing.

- Made from the highest quality plastic
- All threads accept standard garden hose fittings
- Threaded fittings don't come apart under pressure
- Debris screens easily screw into your extensions
- Overflow extensions allow user to raise or lower water levels



Get the combo kit for great value!

ACTIVE AQUA FILL/ DRAIN COMBO KIT

Includes two sizes of Active Aqua barbed fill/ drain fittings (AAEFBK2 and AAEFBK3), two extension fittings (AAEFEX1), and two screen fittings (AAEFSC1).

Computer designed barbed ends ensure a secure fit

ACTIVE AQUA FILL/ DRAIN COMBO KIT

ITEM CODE	DESCRIPTION	SRP
AAKEF2	Active Aqua Fill/Drain Combo Kit	\$5.95

ACTIVE AQUA FILL/ DRAIN FITTINGS

ITEM CODE	DESCRIPTION	PER BG	SRP
AAEFBK2	Active Aqua 1/2" Fill/Drain Fitting	10	\$16.95
AAEFBK3	Active Aqua 3/4" Fill/Drain Fitting	10	18.95
AAEFBK4	Active Aqua 1" Fill/Drain Fitting	10	19.95
AAEFEX1	Active Aqua Extension Fitting	10	5.95
AAEFSC1	Active Aqua Screen Fitting	10	5.95
AAEFWA1	Active Aqua Washer Fitting	10	3.95



Premium quality at an affordable price

STRONG · DURABLE · LOW MAINTENANCE

ACTIVE AQUA PREMIUM WHITE RESERVOIRS & COVERS

The Active Aqua line of premium white reservoirs and covers offers features that rival the competition at value prices. These reservoirs are thicker all around than most other brands, with slightly concave sides to improve strength and avoid bowing. They feature stronger corners and a low profile to fit under flood tables and other hydroponic systems.

- Multi-level drill access points for automated drainage, float valves, or other improvements
- Inside gradation to verify water level
- True, full-size dimensions and volume to provide maximum growing area
- Made from durable, high-impact ABS plastic with UV resistance for longevity
- Stronger corners and thicker walls than any others in their class



HGRES115K
Includes HGRES115PWB, HGRES115PWC, and HGRESPPHC



HGRES70K
Includes HGRES70PWB, HGRES70PWC, and HGRESPPHC



HGRES40K
Includes HGRES40PWB, HGRES40PWC, and HGRESPPHC



HGRES20K
Includes HGRES20PWB, HGRES20PWC, and HGRESPPHC

ACTIVE AQUA PREMIUM RESERVOIR COVER & PORTHOLE COVER

Our premium reservoir covers are slightly convex with a ribbed design for strength. They fit inside the reservoir top to guarantee that any water that may collect on top falls back into the reservoir. They feature a convenient access porthole (cover available separately) and multi-drill access points to install various meters and pump cords. Porthole cover fits all of our premium reservoir covers.

ACTIVE AQUA PREMIUM RESERVOIR KITS

Our convenient Premium Reservoir Kits include one reservoir, one cover, and one porthole cover – a great value at an affordable price.



ITEM CODE	DESCRIPTION	DIMENSIONS	SRP
HGRES115K	115 gal Reservoir Kit Premium White	52.75" x 47.25" x 15"	\$364.95
HGRES70K	70 gal Reservoir Kit Premium White	55.25" x 38.25" x 12"	268.95
HGRES40K	40 gal Reservoir Kit Premium White	38.5" x 33.5" x 12"	144.95
HGRES20K	20 gal Reservoir Kit Premium White	31.5" x 24.5" x 11"	104.95
HGRES115PWB	115 gal Reservoir Premium White	52.75" x 47.25" x 15"	\$238.95
HGRES70PWB	70 gal Reservoir Premium White	55.25" x 38.25" x 12"	185.95
HGRES40PWB	40 gal Reservoir Premium White	38.5" x 33.5" x 12"	89.95
HGRES20PWB	20 gal Reservoir Premium White	31.5" x 24.5" x 11"	61.95
HGRES115PWC	115 gal Res Cover Premium White	52.75" x 47.25" x 1.25"	\$146.95
HGRES70PWC	70 gal Res Cover Premium White	55.25" x 38.25" x 1.25"	95.95
HGRES40PWC	40 gal Res Cover Premium White	38.5" x 33.5" x 1.25"	57.95
HGRES20PWC	20 gal Res Cover Premium White	31.5" x 24.5" x 1.25"	42.95
HGRESPPHC	Premium White Porthole Cover	9" x 6" x 1"	\$8.95



ACTIVE AQUA RESERVOIRS, COVERS & PORTS

Our line of flood tables, reservoirs and covers offer features that rival the competition at value prices.

- True, full-size dimensions and volume to provide maximum growing area
- Made from durable, high-impact ABS plastic with UV resistance for longevity
- Low profile to fit under flood tables and other hydroponic systems
- Slightly convex & ribbed cover design for strength and drainage of any water that may collect on top
- Convenient access porthole (available separately)
- Superior grid pattern design and multi-level drainage channels to promote fast and thorough drainage
- Rounded corners for easy cleaning



Add a floating thermometer for temperature at a glance!

See page 309



ITEM CODE	DESCRIPTION	SRP
HGRES25B	25 gal Reservoir, 30" x 30" x 13"	\$65.95
HGRESS0B	50 gal Reservoir, 39.5" x 39.5" x 13"	96.95
HGRES75B	75 gal Reservoir, 46.5" x 46.5" x 13"	136.95
HGRES100B	100 gal Reservoir, 53" x 53" x 13"	189.95
HGRES25C	25 gal Reservoir Cover, 7" x 27"	\$34.95
HGRESS0C	50 gal Reservoir Cover, 36.5" x 36.5"	47.95
HGRES75C	75 gal Reservoir Cover, 43.5" x 43.5"	66.95
HGRES100C	100 gal Reservoir Cover, 50" x 50"	93.95
HGRESPHC	Porthole Cover, fits all sizes	8.95

ACTIVE AQUA DOMES & COVERS

Active Aqua humidity domes fit our flood tables perfectly and feature 3-way ventilation for superior temperature and humidity control with vents on the top and on the side. These tall (8.5" high), sturdy domes accommodate larger plants for increased growing volume. Our white flood tray covers reflect light to minimize heat buildup.



Patented design

ITEM CODE	DESCRIPTION	SRP
HGFTDM22	2' x 2' Humidity Dome (fits HGFT22)	\$69.95
HGFTDM33	3' x 3' Humidity Dome (fits HGFT33)	103.95
HGFTDM24	2' x 4' Humidity Dome (fits HGFT24)	134.95
HGFT24COV	2' x 4' Flood Table Cover (fits HGFT24)	\$66.95
HGFT33COV	3' x 3' Flood Table Cover (fits HGFT33)	87.95
HGFT44COV	4' x 4' Flood Table Cover (fits HGFT44 and HGFTW44)	145.95



Sign up for our email blast!



Premium Giveaways



New Product Launches



Gardening Tips



Contests to Win Big!



Winners are Chosen Every Month

Prizes include, but are not limited to, products and gear from these premium Hydrofarm brands!

ActiveAQUA
HYDRO CULTURE

autopilot
Environmental Controllers

ACTIVE AIR

PHANTOM



**SIGN UP
HERE!**

Scan the QR code, or visit Hydrofarm.com and click "Sign up for new product info and giveaways!"



Get Connected with the Hydrofarm Community:



Like us on Facebook, follow us on Twitter, and check out Hydrofarmtv on YouTube and Instagram!

HYDROFARM
hydrofarm.com



Fill the Root Spa with your favorite nutrient solution and watch your plants grow!

ROOT SPA COMPLETE DEEP WATER CULTURE SYSTEM

The Root Spa Deep Water Culture System is a fun and simple DIY bucket system that offers an effective method for delivering optimal levels of water, nutrient, and oxygen to your plants. Fill up The Root Spa with your favorite grow medium and nutrient solution, and watch your plants grow! After a very short time, you will realize the advantage of the simplicity of this uniquely easy-to-use, inexpensive, and forgiving system! Pumping raw air into the nutrient solution, without the need of expensive and often troublesome air stones, is not only cost effective, but your plants will also thrive!

Includes:

- DIY bucket (HG5DIYB – see page 368) – also available with 4 and 8 buckets
- 10" (3 gallon) bucket basket to hold your choice of growing medium
- Multipurpose air hose to deliver air from the pump to the bottom of the bucket
- External air pump to oxygenate your water to encourage root growth
- .5" grommet fitting
- .5" elbow fitting
- .25" black tubing
- Air hose retainer
- Instruction manual

Clay pebble media sold separately.



Ideal for use with clay pebbles

Sold separately – see page 179



RSSGALSYS includes EMPUMP air pump with 1 outlet



RSSGAL4SYS includes AAPA15L air pump with 4 outlets



Easy to assemble & use – no tools required!

RSSGAL8SYS includes AAPA25L air pump with 8 outlets



ROOT SPA

ITEM CODE	DESCRIPTION	SRP
RSSGALSYS	Root Spa 5 Gal Bucket System	\$34.95
RSSGAL4SYS	Root Spa 5 Gal 4 Bucket System	119.95
RSSGAL8SYS	Root Spa 5 Gal 8 Bucket System	199.95
HG5DIYB	DIY Bucket, 5 gal	\$6.95
HG5DIYL	DIY Bucket Lid	2.95

See video of the Root Spa in action!



EMILY'S GARDEN™ SYSTEM

This 6"H x 16"W x 24"L garden with 6 individual planters allows you to rotate or add new plants as you please. It will fit just about anywhere – on a bench, a shelf, table, or out on the patio. Also available without media so you can customize your system with media of your choice.

System includes:

- 2 gal reservoir
- Growing media
- UL-listed air pump 
- Tubing
- Six 7"H x 6"W x 6"L planters
- Seed starter cubes
- Molded cover
- Nutrient
- Water level indicator
- pH test kit
- Illustrated instructions



Water level indicator

Add a Mini Sunburst

(See page 51)

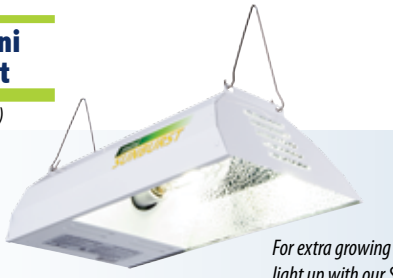

For extra growing power light up with our Sunburst all-in-one grow light

ITEM CODE	DESCRIPTION	SRP
EMSYST	Emily's Garden System	\$99.95
EMSYSTEM	Emily's Garden, No Media	\$89.95

MEGAGARDEN™ SYSTEM

Get the convenience of an ebb & flow system in a 10"H x 22"W x 22"L size garden. Ebb & flow systems work by pumping nutrient solution up from a reservoir to a controlled water level tray. All plants are watered uniformly on a timed cycle. Also available without media so you can customize your system with media of your choice.

System includes:

- 7.5 gal reservoir
- Growing media
- Insert grow tray
- Fifteen 5.5" square planters
- UL-listed submersible pump and timer 
- Nutrient
- Seed starter cubes
- pH test kit
- Water level indicator
- Illustrated instructions

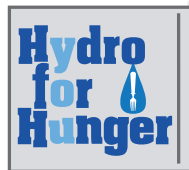

ITEM CODE	DESCRIPTION	SRP
MGSYS	MegaGarden System	\$179.95
MGSYSNM	MegaGarden, No Media	\$159.95

TOMATO PLANTERS

Hydrofarm's self-watering tomato planters provide lightweight, strong support for tomatoes, beans, peas, and other climbing plants, and flowers. An easy-fill reservoir system delivers water and nutrients from below, helping avoid over- or underwatering. The sturdy frame construction helps support the weight of vines as they grow, allowing the plant to devote more energy to developing fruit – and preventing the fruit from falling off before it's ripe.

- Expandable – as plants grow, just add extra risers or rings
- Convenient watering port makes refilling easy
- Simple to assemble – no tools required
- Breaks down for easy storage
- Durable plastic construction

TOMATO BARREL™

GCTB

- Trellis expands to 4 feet tall
- Planter holds .75 cu ft
- Reservoir holds 1.5 gallons
- Includes round base and planter, 4 support rings, and 4 connecting risers
- Extra rings & risers available separately – make your own tomato cage! (Item #GCTC)

SIZE: 14.75" dia. x 11.5" tall



GCTB

Watering port

TOMATO & PEPPER TREE™

GCTT

- Trellis expands to 3 feet tall
- Planter holds .75 cu ft
- Reservoir holds .75 gallons
- Includes square base and planter, 3 support rings, and 3 connecting risers

SIZE: 11"W x 8"H x 11"L



Trellis ring

GCTT

Self-watering planter

Water reservoir

TOMATO TRELLIS™

GARDEN ON WHEELS GCTR

- Trellis expands to 4 feet tall
- Planter holds 1.5 cu ft
- Reservoir holds 2.5 gallons
- Includes rectangular base and planter, 3 risers with supports, and 2 side support brackets

SIZE: 13.5"W x 13.75"H x 29"L

Great for peppers and tomatoes!



a Hydrofarm exclusive

Snap together trellis

GCTR



Wheels & handle make moving easy

Watering port

TOMATO CAGE™

GCTC

- Three ring extension
- Expands to 4 feet tall

SIZE: 14.25" dia. x 13.5" risers



ITEM CODE	DESCRIPTION	SRP
GCTB	Tomato Barrel with 4 ft Tower	\$33.95
GCTT	Tomato Tree with 3 ft Tower	20.95
GCTR	Tomato Trellis with 4 ft Trellis	65.95
GCTC	Tomato Cage Extension	\$8.95



Features and flexibility you want at a price you can afford

Active Aqua's Grow Flow is the most efficient ebb & flow system on the market. With the Grow Flow's easy-to-program controller unit, you can pretty much "set it and forget it." And since your pumps are only pumping a short time each day, the system is extremely reliable and efficient. Just set the fill and drain cycles, and the controller unit does the rest!

As for safety, the Grow Flow is the only unit available with fail-safe overflow protection. If the float valve stops operating, the LED indicator lights up on the control panel and the emergency shut-off valve automatically shuts down the system, preventing any spillage or damage to your growing area.

Have bigger plans? With our convenient Grow Flow Expansion Kits* you can connect up to 24 growing modules to a single 5-gallon system – and up to 48 modules with the 2-gallon system! You can also build your own system from the ground up by purchasing all the components individually.

*Each kit includes 6 growing modules; see facing page for details.

EFFICIENT, CONVENIENT CUSTOMIZABLE

Grow Flow is available as a 12-site Complete System, or you can create a custom setup by purchasing individual components.

- Adjustable float ladder and emergency shut-off valve
- LED emergency indicator light
- Each growing module consists of one outer bucket and one inner bucket – making it easy to lift and move plants
- Tubing and fittings are sized for fast flood and drain times
- Water pumps operate on 120V
- Each controller unit can control up to 24 of our 5-gallon growing modules, and up to 48 2-gallon modules

Now available in two sizes – 5-gallon and 2-gallon

GROW FLOW EBB & FLOW COMPLETE SYSTEM

Save money in your initial setup! The Grow Flow System has everything you need to get started, right down to the fittings and tubing. 12-site complete system.

Includes:

- 7-gallon digital controller unit with 3-year warranty
- Tubing and fittings
- 55-gallon distribution reservoir with drilled lid and lock
- Two 250 GPH high-flow pumps 
- Twelve bucket modules (available in 2-gallon or 5-gallon sizes)

ITEM CODE	DESCRIPTION	SRP
GF07KT5	Grow Flow 5 Gal System with Controller Unit & 3/4" tubing	\$599.95
GF07KT	Grow Flow 2 Gal System with Controller Unit & 1/2" tubing	499.95



GF07KT
(2-gallon system not shown)



Systems come complete with heavy duty pots and fittings

For the ultimate in customization, purchase Grow Flow components separately and build your own system



GROW FLOW CONTROLLER UNIT (GF07CB)

Each Grow Flow Controller Unit can control up to 24 of our 5-gallon growing modules, and up to 48 2-gallon modules. Includes one 7-gallon controller bucket, premium Grasslin® timer, two 250 GPH pumps, all fittings, 1/2" tubing for pumps, and sample nutrients.

Heavy duty Grow Flow 2.0 Expansion Kit



GROW FLOW 2.0 EXPANSION KIT (GFOE3) 5 GALLON

The Grow Flow 2.0 Expansion Kit includes six growing modules, each consisting of a square, heavy-duty, 5-gallon pot with 3/4" fittings, an inner bucket, and all necessary connectors and tubing. Each pot features multiple drain holes for better water flow.



GROW FLOW EXPANSION KIT (GFOE2) 2 GALLON

The Grow Flow Expansion Kit includes six growing modules, each consisting of a round 2-gallon pot with 1/2" fittings, an inner bucket, and all necessary connectors and tubing. Each pot features concave bottom with multiple drain holes for better water flow.



GROW FLOW 1/2" AND 3/4" HARDWARE KITS (GFTH AND GFEH)

The Grow Flow Tee Hardware Kit (GFTH) includes six each of 1/2" tees, drain tees, and mounting nuts, and 12 washers. The Grow Flow Elbow Hardware Kit (GFEH) includes six each of 1/2" elbows, drain screens, and mounting nuts, and 12 washers.



55 GALLON RESERVOIR DRUM (DRM58T)

The multi-purpose, heavy-duty reservoir barrel is made of FDA-approved, high-density polyethylene so it's lightweight and won't dent, rust, or peel. Easy to read levels are marked on the side. Open head design includes plastic lid with pre-drilled opening and metal clamp for secure closing. Dimensions: 22.0"L x 22.0"W x 36.5"H.

- Easy to read levels on side
- Lid clamps securely



SUBMERSIBLE PUMP (GFOPUMP)

The Grow Flow Submersible 120V, 251 GPH pump is recommended for 10-60 gallon reservoirs. Great for indoor or outdoor use, it's oil free and environmentally safe.

An inside look at the Grow Flow Controller

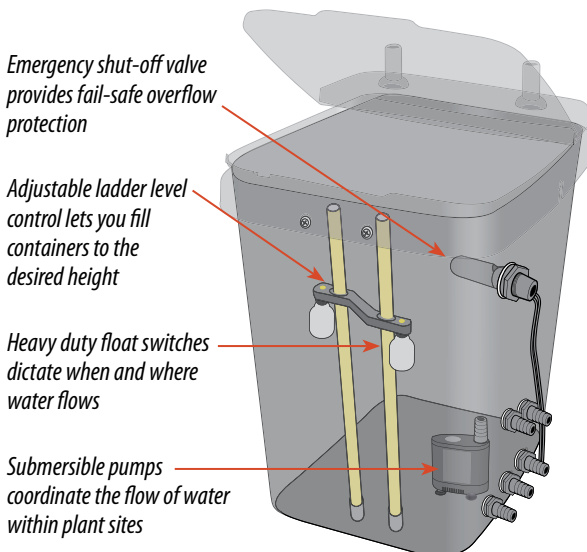

GROW FLOW EBB & FLOW COMPONENTS

ITEM CODE	DESCRIPTION	SRP
GF07CB	Grow Flow Ebb & Flow Controller Unit w/2 pumps	\$279.95
GFOE3	Grow Flow 2.0 Expansion Kit w/six 5-gal square pots	\$89.95
GFOE2	Grow Flow Expansion Kit w/six 2-gal round pots	69.95
GFTH	Grow Flow Tee Hardware Kit, 6/pk	\$11.97
GFEH	Grow Flow Elbow Hardware Kit, 6/pk	11.97
DRM58T	55 Gallon Reservoir Drum w/Pre-Drilled Lid	\$116.95
GFOPUMP	Grow Flow Submersible Pump 251 GPH	\$19.95

EBB & GRO HYDRO SYSTEM AND COMPONENTS

The Ebb & Gro system works by connecting all of the grow pots to the controller unit. All necessary tubing is included with the system. Just set the timer and the system will fill and drain the pots three to four times a day. When the fill and drain cycle comes on, it turns on the pump in the large reservoir (the 55 gallon drum) and starts filling the controller unit. Since the grow pots are all plumbed to the controller unit, the water in the entire system starts to level off with the controller unit. When the pots are full, and your drain cycle starts, the pump in the controller unit pumps all of the water back into the reservoir. When the level of the water in the controller unit goes down, all of the grow pot's levels go down also. Then the controller unit waits for the next fill and drain cycle a few hours later.

EBB & GRO EXPANSION KIT *CAEBBEXP6*

Expand your Ebb & Gro hydroponic system up to 48 modules! Includes six 2-gallon modules with perforated grow pots, and all tubing and fittings. Connects to existing controller and 55-gallon reservoir.



EBB & GRO CONTROLLER UNIT *CAEBBCTR*

Includes 2 pumps and a 3.5 gallon reservoir – you supply the pots. This is the same controller unit that comes with the Ebb & Gro Hydro System.



System expands up to 48 modules



ITEM CODE	DESCRIPTION	SRP
CAEBB12	Ebb & Gro Hydro System, Complete	\$539.95
CAEBBEXP6	Ebb & Gro Expansion Kit, 6 Pots, Tubing & Fittings	\$74.95
CAEBBCTR	Ebb & Gro Controller Unit w/ 2 pumps, 3.5 gal reservoir	274.95

THE EBB MONSTER 6 POT SYSTEM

Comes complete with a 55 gallon reservoir and the Ebb Monster Controller Module to efficiently and effectively transfer nutrients to your plants on whatever schedule you set. Includes six 5-gallon grow pot sets, 3/4" tubing, and fittings.

EBB MONSTER CONTROLLER *CAEBBMCTR* The backbone of our EBB Monster System, now available as a standalone controller. Use to control the fill and drain cycles on the schedule you set.



Expandable up to 12 sites



ITEM CODE	DESCRIPTION	SRP
CAEBBM6	Monster 6 Grow Pot Complete w/ 55 Gal Reservoir	\$639.95
CAEBBMEXP3	Monster Grow 3-Pot Expansion Kit	82.95
CAEBBMRCKIT	Ebb Monster Kit, 55 Gal Drum & 3.5 Gallon Controller	459.95
CAEBBMCTR	Monster Ebb Controller Module Only	274.95
CAPMP018	Ebb & Gro Pump, 340 GPH	21.95
CAPMP026	Ebb Monster Pump, 530 GPH	36.95

NEOPRENE INSERTS

These neoprene inserts are pre-slit and come in convenient sheets. Available in black or mixed color packs to help you keep track of cutting varieties.



ITEM CODE	DESCRIPTION	SRP
HGNE02B	Neoprene Insert 2", Black, 35/pk	\$13.95
HGNE02MC	Neoprene Insert 2", Mixed Colors, 100/pk	39.95
HGNE03B	Neoprene Insert 3", Black, 25/pk	\$19.95

PLANT!T BIG FLOAT AUTO TOP-UP KIT



The PLANT!T BigFloat Auto Top-Up kit lets you connect a secondary header tank to your existing reservoirs – then, using gravity and a low-pressure float valve, it automatically tops-up and maintains nutrient levels in your system. Spend less time filling and inspecting your tanks, and protect your plants from drying out if your reservoir runs low. No pump required. The kit contains everything you need – simply attach to the header tank of your choice up to 400 L (sold separately). Includes:

- 1 x 2 meters 13 mm flexible pipe
- 1 x 13 mm barbed tee
- 1 x 13 mm nut and tail with .75" BSP
- 1 x 13 mm poly to hose connector
- 1 x grey low pressure float valve



ITEM CODE	DESCRIPTION	SRP
GMBF	PLANT!T Big Float Auto Top-Up Kit	\$24.95

TELESCOPIC FLOOD TABLE GROOVE BRUSH

Clean flood tables from a standing position! Telescopic handle and stiff nylon bevel cut bristles to help clean hard-to-reach corners and inner channels. Pivoting brush head measures 7.5".



ITEM CODE	DESCRIPTION	SRP
HGSB	Telescopic Flood Table Groove Brush	\$39.95

DRILL BIT FOR DRAIN INSTALLATIONS & DEBURRING TOOL

1/4" to 1 3/8" step in 1/8" increments drill bit for plastic containers. Don't forget to also purchase a deburring tool (at right) to get a leak-free installation of drains and fittings. Quickly removes sharp edges – use on all plastic modifications. Great for removing burrs from holes drilled in lids and grow trays. Eliminates the chances of leaks created by an uneven drainage hole.



ITEM CODE	DESCRIPTION	SRP
HGDRBT	Drill Bit for Drain Installations	\$29.95
HGDEBURR	Deburring Tool	12.95

FLOATING THERMOMETER

Easy and accurate, this gauge floats and has a pressure-sensitive backing for easy mounting. It features readings in both celsius and fahrenheit, as well as clear markings that delineate ideal nutrient temperature.



ITEM CODE	DESCRIPTION	SRP
HGFLT	Floating Thermometer	\$2.09



Please visit us at Hydrofarm.com for more items!



WATERFARM®

The WaterFarm is built out of high-impact plastic to assure a long service life. Unique square design allows growers to closely pack WaterFarm modules in order to create large, high-density installations. Will grow small, medium, and large plants. It has large water capacity and low water requirements, simple and efficient. As it offers all the features of larger systems at a lower cost without sacrificing quality or performance, the WaterFarm is one of the very best buys.

WATERFARM COMPLETE

Includes 4-gallon reservoir, grow chamber, farm kit, pump, tubing, nutrients and media.



GH4120

Sold as complete kit or individual components

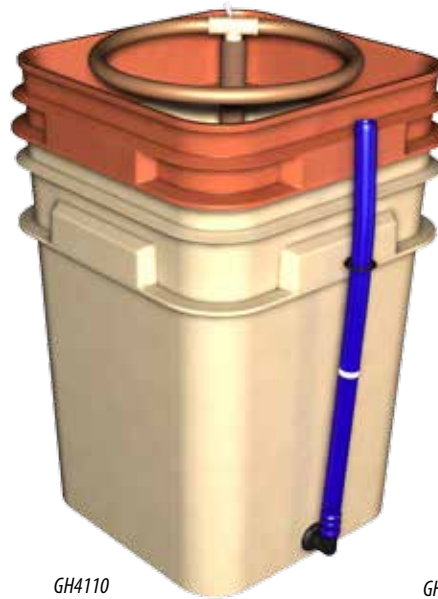

GH4110



GH4116



GH4140



GH4150

ITEM CODE	DESCRIPTION	SRP
GH4120	WaterFarm Complete	\$65.63
GH4110	WaterFarm Module w/ Farm Kit	46.00
GH4116	Waterfarm Farm Kit (10/cs)	\$14.30
GH4140	Waterfarm Replacement Grow Chamber	13.00
GH4150	WaterFarm Replacement 4 Gal Reservoir	25.00

WATERFARM® 8-PACK

The WaterFarm 8-pack is eight WaterFarm module units connected to one General Hydroponics Controller consisting of an integrated 13-gallon reservoir and an 8-gallon controller unit. The Controller will keep each unit topped off with the correct level of nutrient for low maintenance. The kit is powered by GH's dual diaphragm air pump and includes all the necessary hardware, supplies, and General Hydroponics Flora Series nutrients. Arrange the WaterFarm units in a design suitable for any environment. Pack them tight or space them out for your growing situation. The WaterFarm 8-Pack is the system for big growers.

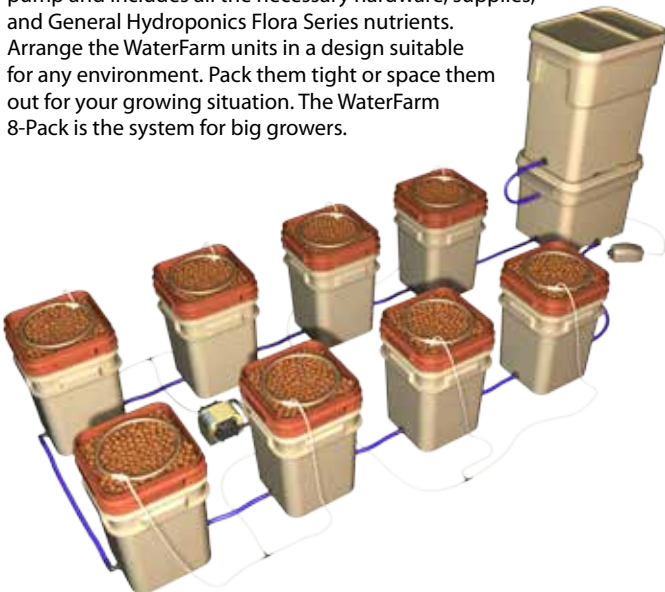

ITEM CODE	DESCRIPTION	SRP
GH4720	WaterFarm Controller Kit - Terra Cotta (Kit of 8 Farms & Controller)	\$514.60

POWERCROWER ECO

The PowerGrower Eco incorporates numerous design innovations and is protected by several patents. It is 15" across the top and 15" tall and consists of a single growing chamber at the top with an integrated reservoir below. The unique hexagonal shape lets you place units close together when plants are small, and then separate them as the plants mature and grow.



ITEM CODE	DESCRIPTION	SRP
GH4830	Power Grower Eco Complete	\$108.00
GH4831	Power Grower Eco Module	79.80
GH4832	Power Grower 8 Pack (2 box)	687.48



ECOGROWER MAX & MEGAFARM

THE ECOGROWER incorporates an air driven "spider" drip system and a revolutionary 17-gallon hexagonal reservoir with removable 6" lid inserts. Each lid insert accommodates one 6" net pot. Dimensions: 2' x 2' x 2'.

THE MEGAFARM is GH's largest (22" x 22" x 22") drip hydroponic module. The unique 20-gallon growing chamber sits on top of a 20 gal reservoir. A dual drip ring is utilized to allow for unlimited planting options. The MegaFarm will grow all sizes of plants, including many varieties of trees. Large water capacity and low water requirements make the MegaFarm simple and efficient.



GH4920



GH8005

ITEM CODE	DESCRIPTION	SRP
GH4920	EcoGrower Max	\$233.75
GH8005	MegaFarm	387.00

EUROGROWER DRIP HYDROPONICS

Ideal for new hydroponic gardeners, the Eurogrower provides users with a simple, yet efficient approach to home hydroponics. The heart of the system is the custom designed 40-gallon Panda reservoir, which is more than adequate for its eight 2-gallon buckets. Whether using a soil or soilless medium, growers can use the EuroGrower virtually anywhere. Comes complete with Flora Series nutrients.



GH5400

ITEM CODE	DESCRIPTION	SRP
GH5400	EuroGrower, 8 Pots Complete	\$616.65

RAINFORREST 318/236/66 AEROPONICS

Perfect for propagating cuttings or for starting seeds, seedlings, or transplants. The Vortex Sprayer lifts and oxygenates nutrient solution then gently distributes it over cutting base or root system, for more oxygen in the root zone. Start plants in RainForest Modules and later transplant them into larger systems like our WaterFarm. Several RainForest modules can be connected to a Texas Controller for larger installations.



GH6600

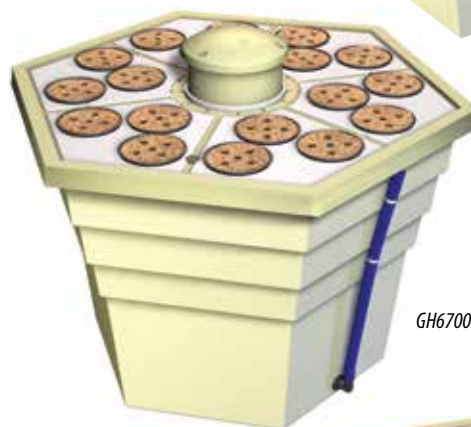

GH6700

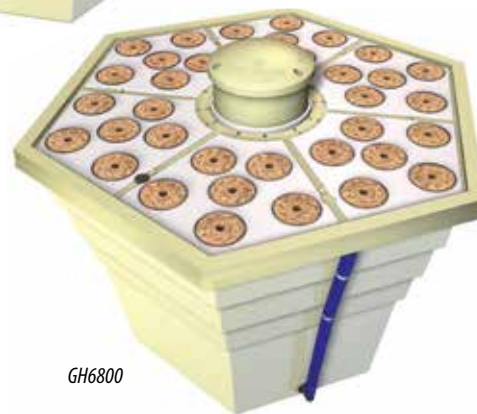

GH6800

ITEM CODE	DESCRIPTION	SRP
GH6800	RainForest Modular 236 - Vortex Sprayer	\$291.50
GH6610	RainForest Modular 66 Lid Insert Kit - Six 6" Lid Inserts, 6-6" Grow Cups	71.25
GH6710	RainForest Modular 318 Lid Insert Kit - Six 3" Lid Inserts, 18-3" Grow Cups	75.00
GH6810	RainForest Modular 236 Lid Insert Kit - Six 2" Lid Inserts, 36-2" Grow Cups	72.50



AEROFLO® AEROPONICS

By generating a fine mist of nutrient solution, AeroFlo Aeroponics systems optimize the oxygen/water/nutrient ratio for plant roots and provide ideal conditions for all stages of growth. Plants' roots grow in the moist air space between the net cups and hang in a shallow, constantly circulating bath of super-oxygenated nutrient solution. Systems come with everything you need to get started – net cups, coco inserts, pump, all plumbing and fittings, leg stand, and nutrient solution.

AEROFLO® 18 AEROPONICS

GH8006 – With a 17-gallon reservoir and 18 plant sites, the AeroFlo 18 site is perfect for those who want a compact, high performance system. It is particularly well-suited to growing lettuce, basil, and other small plants up to three feet in height.

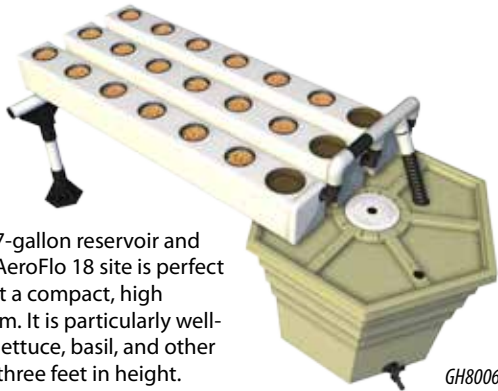

AEROFLO2® 20 AEROPONICS

GH8000 – A twenty site system and an excellent choice for growing small crops such as lettuce, cucumbers, peppers, basil, and other herbs. Varieties of flowers and tomatoes that do not grow taller than three feet will also do well. Works beautifully when placed near a sunny window in your home or office.

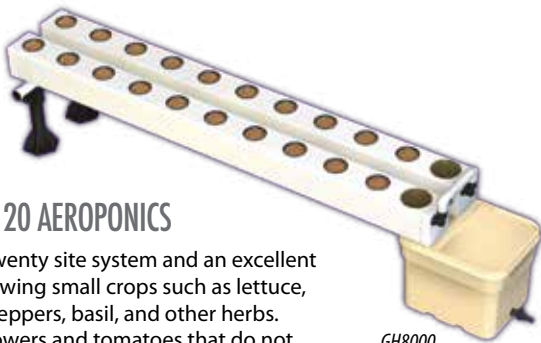

AEROFLO® 30 AEROPONICS

GH8008 – With a 20-gallon reservoir and thirty plant sites, the three grow chambers can be kept side-by-side or fanned out in a radial pattern to maximize growth on lower branches. A perfect system for those who want a smaller, high performance system. Excellent for growing lettuce, basil, and other smaller plants up to 4' in height.

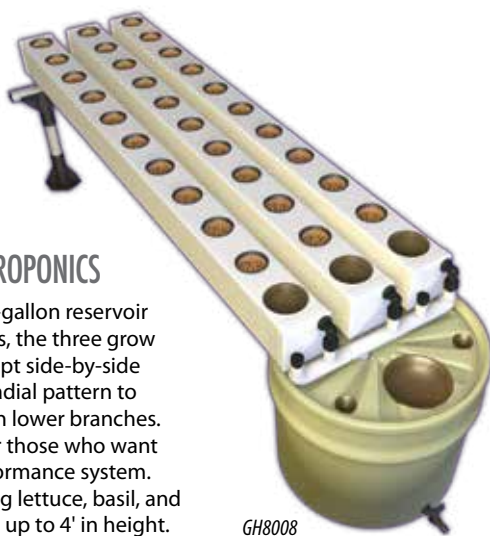

AEROFLO2® 36 AEROPONICS

GH8004 – Designed specifically for indoor cultivation under a grow light, the AF236 system offers 36 plant sites in a compact footprint. It also features the generous 40-gallon Panda reservoir.



AEROFLO2® 60/120 AEROPONICS

GH8002 – Our largest AeroFlo2 unit, the AF260, features sixty plant sites. Growers who wish to expand this system can enjoy a total of 120 plant sites with the addition of our AeroFlo2 60 extension unit. Users can choose either to configure the grow chambers on the same side or to stagger them in order to cover a larger area or to grow larger plants. The AF260 and extension unit feature the generous 40-gallon Panda reservoir.

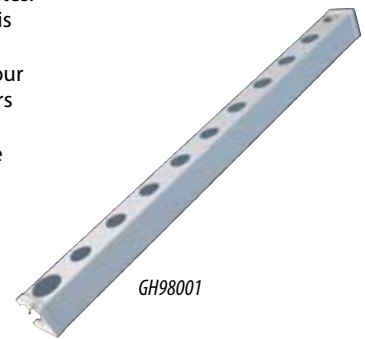

ITEM CODE	DESCRIPTION	SRP
GH8006	Aeroflo - 18 Site 2' x 5'2"	\$429.00
GH8000	Aeroflo 2 - 20 Site 1" x 7" (2Bx)	\$421.67
GH8008	AeroFlo - 30 Sites (2' x 7'), 20 Gal. Res, 3 - 6ft. chambers	\$559.98
GH8004	AeroFlo2 - 36 Sites (3' x 4'), 40 Gal. Res, 6 - 4 ft. chambers	\$937.74
GH8002	AeroFlo2 - 60 Sites (6' x 6'), 35 gal Res, 6 - 6 ft chambers	\$1173.33
GH8003	AeroFlo2 - 60 Sites Extension (120 Sites) (5' x 6')	935.00
GH8023	AeroFlo2 - 60 Manifold	70.00
GH98001	AeroFlo2 - 6 ft.Sq. Chamber- Drilled on 7" Centers for 3" Net Cups	\$98.08

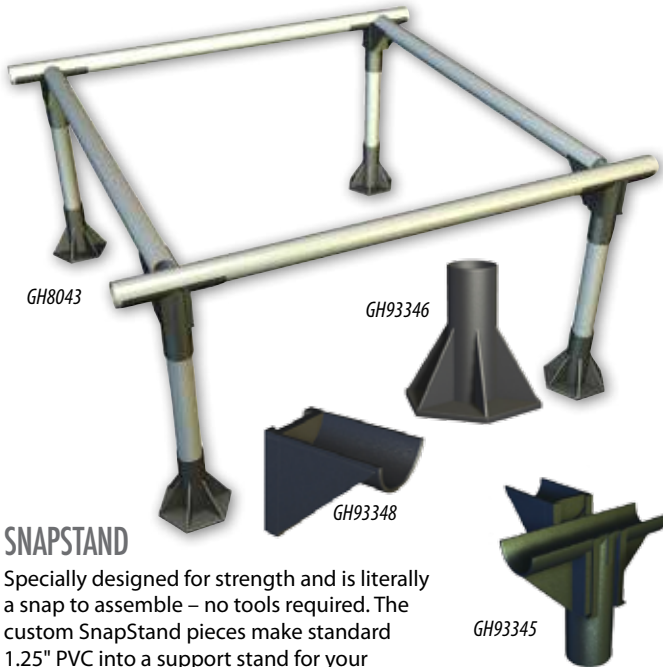

SNAPSTAND

Specially designed for strength and is literally a snap to assemble – no tools required. The custom SnapStand pieces make standard 1.25" PVC into a support stand for your system or as many uses as the grower's imagination can conceive.

ITEM CODE	DESCRIPTION	SRP
GH8043	Snapure 4' x 4' Tray Stand	\$90.00
GH93345	SnapStand Cross Fitting	4.79
GH93346	SnapStand Foot Base	4.79
GH93348	SnapStand Dovetail 90 degree	3.79

PANDA RESERVOIR

The 40-gallon Panda reservoir has a white exterior to reflect light and heat and is black on the inside to discourage algae growth. Its sleek design fits into tighter spots to optimize space. Convenient access hatch makes nutrient changes a breeze. Float valves and drain kits are also available.



ITEM CODE	DESCRIPTION	SRP
GH93351	Panda Reservoir w/out Lid, 40 Gal	\$142.00
GH93380	Panda Reservoir Lid, 40 Gal	92.00

CONTROLLER SYSTEM

A container with a float valve connected to the line of units. A master reservoir filled with fresh water and nutrients is located on top of the float-valve activated controller. As the plants draw water from their individual reservoirs, the liquid levels drop, causing the float valve in the controller to open and draw fresh nutrients from the master reservoir. This automatically maintains the ideal nutrient level in all the interconnected units. Simple, elegant, reliable, and inexpensive.



- Controller includes:**
- Seven .5" barbed tees
 - 13-gallon reservoir with grommet
 - 8-gallon controller with float valve fittings
 - Blue .5" tubing
 - Two .5" elbows

Dimensions:
3'6"H x 12"W x 12"L

ITEM CODE	DESCRIPTION	SRP
GH4520	Controller System (accommodates 8 Farm Modules)	\$134.36

TEXAS CONTROLLER

Unit includes a 20-gallon reservoir with grommet, 20-gallon controller with float valve, fittings, fifteen .5" barbed tees, .5" tubing, and two .5" elbows. Dimensions: 3' 6"H x 2'W x 2'L



ITEM CODE	DESCRIPTION	SRP
GH4610	Texas Controller (accommodates 16 Farm Modules)	\$372.00



NEOPRENE INSERTS

Custom made neoprene collars are pre-slit for easy insertion of cuttings.



360° CLONE SPINNER & AEROPONIC MISTER

ITEM CODE	DESCRIPTION	SRP
BCPTNE02	Botanicare Neoprene Insert, 2", 25/pk	\$14.50
BCPTNE03	Botanicare Neoprene Insert, 3", 25/pk	23.94
BCPTNE03.75	Botanicare Neoprene Insert, 3.75", 25/pk	35.28
BCPTNE05	Botanicare Neoprene Insert, 5", 25/pk	50.40
BCPTNEOPC	Botanicare Neoprene Insert for Power Clone, 1.625", 25/pk	13.95
BCCLSPIN	360 Degree Clone Spinner	\$1.45
BCFTSPRAY180	180 Aeroponic Mister, 50/pk	\$14.75
BCFTSPRAY330	360 Aeroponic Mister, 50/pk	14.75



Please visit us at Hydrofarm.com for more items!



POWER CLONER

Botanicare Power Cloners underwent a series of improvements and modifications to provide gardens of all sizes consistent, reliable production. Redeveloped with a Botanicare low profile reservoir, these systems decrease propagation time.

- Unique Botanicare cord guide designed to block sprayed solution & improve cord management
- Drainage grid with a recessed pump
- An internally seated tray
- Humidome™ options
- Customizable points for installation of spouts and fittings
- Botanicare ceramic airstones with air pump
- Water volume indicator
- Dense neoprenes



BCHSCLPCBA45



BCHSCLPCWA45



BCHSCLPCWB77



BCHSCLPCBB77



BCHSCLPCWC180, also in black, not shown

ITEM CODE	DESCRIPTION	SRP
BCHSCLPCBA45	Power Cloner 45, Black	\$299.95
BCHSCLPCBB77	Power Cloner 77, Black	379.95
BCHSCLPCBC180	Power Cloner 180, Black (not shown)	581.50
BCHSCLPCWA45	Power Cloner 45, White w/dome	\$363.25
BCHSCLPCWB77	Power Cloner 77, White w/dome	474.95
BCHSCLPCWC180	Power Cloner 180, White w/dome	737.00

White Cloners also include AquaShield and ZHO.



**100%
recyclable!**



EZ-CLONE CLASSIC CUTTING SYSTEM

The new EZ-CLONE Classic already lives up to its name! It has been made from fully recyclable HDPE which is highly chemically resistant and extremely durable. Every detail of its design has been thought out; from the leak resistant cord outlet that allows multiple cords to the specially designed recessed drain that allows it to be highly protected and gives the ability to easily tip the unit for draining. These are just some of the 75+ improvements designed specifically to make cloning even easier.

ITEM CODE	DESCRIPTION	SRP
EZCL16	EZ-Clone Classic 16 Cutting System	\$159.95
EZCL32	EZ-Clone Classic 32 Cutting System	249.95
EZCL64	EZ-Clone Classic 64 Cutting System	319.95



EZ-CLONE COLORED CLONING COLLARS

EZ-CLONE Colored Cloning Collars are designed specifically to be used in the EZ-CLONE Cloning System. They are manufactured from a sterile material and are engineered to protect and hold your cuttings upright in the lid, exposing the top leaves to air and light, while allowing the stems of your cuttings to be completely unrestricted to the inside of the misting chamber. Currently, EZ-CLONE Colored Cloning Collars are available in four vivid colors, green, purple, white and grey. All four colors come in packs of 35.

ITEM CODE	DESCRIPTION	SRP
EZCOL35GRN	EZ-Clone Green Cloning Collars, 35 ct	\$15.75
EZCOL35PUR	EZ-Clone Purple Cloning Collars, 35 ct	15.75
EZCOL35WHT	EZ-Clone White Cloning Collars, 35 ct	15.75
EZCOL35GRY	EZ-Clone Gray Cloning Collars, 35 ct	15.75

EZ-CLONE CLONING COLLARS & NEOPRENE INSERTS

Available in both Hard and Soft, EZ-CLONE Cloning Collars are long lasting, sterile and the perfect fit for EZ-CLONE Cloning Systems. Packaged in quantities of 17 for your new EZ-CLONE Classic 16 Site Cloning System, all the way up to a 280 pack for the bulk user.



ITEM CODE	DESCRIPTION	SRP
EZCOL17S	EZ-Clone Soft Cloning Collars, 17 ct	\$9.95
EZCOL35S	EZ-Clone Soft Cloning Collars, 35 ct	15.75
EZCOL65S	EZ-Clone Soft Cloning Collars, 65 ct	29.25
EZCOL35H	EZ-Clone Hard Cloning Collars, 35 ct	\$15.75
EZCOL65H	EZ-Clone Hard Cloning Collars, 65 ct	29.95



Hands-free hydro!

AUTOPOT WATERING SYSTEMS

AutoPot Watering Systems are considered one of the most environmentally friendly watering systems in the world! With AutoPot, the plant uses everything that is supplied to it; there is no loss of water, run-off or leakage. AutoPot Watering Systems are extremely versatile and can be used with the medium / substrate of your choice, including soil, perlite, coco, clay pebbles, rockwool, and more.

- No more daily watering – the system can be left unattended for weeks
- All our systems require no power, pumps or timers to operate
- Simple gravity pressure is all that is required from a reservoir or waterbutt
- Can be used to grow any crop varieties; edible or ornamental
- Adaptable and easily extended in minutes
- Environmentally sustainable

ITEM CODE	DESCRIPTION	SRP
AWCS1040	AutoPot 4-Pot Standard System	\$199.95
AWCS2040	AutoPot 4-Pot XL System	229.95
AWCS1100	AutoPot 1-Pot Standard Module	\$43.50
AWCS2100	AutoPot 1-Pot XL Module	50.50
AWCS1260	AutoPot Root Control Standard Disk Replacement	\$1.80
AWCS2260	AutoPot Root Control XL Disk Replacement	2.70
AWEK1000	AutoPot easy2GO Kit	\$29.95
AWFT0025	FlexiTank, 25 gal	\$79.95
AWFT0060	FlexiTank, 60 gal	108.00
AWFT0105	FlexiTank, 105 gal	180.00
AWFT0200	FlexiTank, 200 gal	260.00
AWFT0265	FlexiTank, 265 gal	350.00

EASY2GO KIT

The easy2GO Kit will keep your plants watered for weeks using a simple gardening tray and reservoir. The easy2GO Kit is placed directly onto the tray along with your potted plants and distributes water to the pots from below. Can be installed anywhere, in the home, greenhouse, conservatory, patio or balcony. Multiple kits can be linked together to keep larger volumes of plants watered. Includes all fittings required to connect to a reservoir of your choice.



AUTOPOT SYSTEM

The 4Pot System is extremely versatile and can be used for a wide range of plant types and sizes. Seasonal flowering plants and perennial shrubs thrive and produce an abundance of blooms and foliage because of the unique action of the AQUAvalve, which is designed to only give the plant the amount of water that it requires – resulting in no wasted water or over/underfeeding. The 4Pot System is easily extended so multiple pots can be linked to a single reservoir. Once set up and the reservoir is filled with water and liquid nutrients, this adaptable system will completely take care of all your plants' needs with minimal monitoring.

	1-Pot standard Module:	1POT XL Module:	4-pot standard System:	4Pot XL system:
Pot	1x 3.9 gallon	1x 6.6 gallon	4x 3.9 gallon	4x 6.6 gallon
1Pot Tray & Lid	1 Standard	1 XL	4 Standard	4 XL
Reservoir & Lid	1x 12.4 gallon	–	1x 12 gallon	1x 12 gallon
AQUAvalve(s)	1	1	4	4
¼" Pipe	5 ft	4.9 ft	13 ft	13 ft
¼" Tee Connectors	–	1	4	4
½" – ¼" Tee Connectors	–	1	–	–
¼" Cross Connectors	–	–	2	2
¼" Filter	1	–	1	–
¼" Top Hat Grommet	1	–	1	1
¼" Inline Tap	1	–	2	2
Root Control Disc	1	1 round	4 black & gold	4 round

FLEXITANK

The FlexiTank is made of a unique flexible material to create up to 200 gallons of water storage that fits where other reservoirs cannot go – and can be packed away and stored at the end of the season. Assembles in minutes with no tools required!

Includes:

- FlexiTank reservoir skin with zippered lid
- Tap
- Support poles

Dimensions when full of water:

- 25 Gallons – 29.5" tall x 17" diameter
- 60 Gallons – 31.9" tall x 25" diameter
- 105 Gallons – 43.7" tall x 26.8" diameter
- 200 Gallons – 46" tall x 35.5" diameter



GROW!T®

See our full line of Coco Coir-based products



mondi™

Unique, innovative products
constructed with premium materials

BUY WITH CONFIDENCE!

FOUNDATION FOR YOUR *HEALTHY* PROPAGATION STARTER KIT

Mondi Easy Grow Combo

The Mini-Greenhouse, Clean & Strong premium propagation tray and Mond Mini Greenhouse Thermo-Hygrometer combine seamlessly into the growers choice propagation solution!



Mondi Mini Greenhouse Thermo-Hygrometer
Temperature and Humidity Meter
model #E100

**Mondi Clean & Strong
premium propagation tray**
model #G170

PAT PENDING

WHY DO YOU BUY MONDI?
It is the only product on the market that uses a proprietary plastic that is non-offgassing.



model #G170

NEW!

features

Clean

- Premium grade virgin materials for cleanliness and durability.
- Premium white plastic for increased light reflectivity.

Strong

- Reinforced outside shell made from recycled materials provide strongest support to date.
- Black base prevents light penetration to the root zone and reduces the chance of root disease.
- Best design 1020 flat (standard propagation tray) on the market.
- Perfectly fits all Mondi Mini Greenhouses.

Clean & Strong premium propagation tray



Super reinforced sides and lip, thick plastic and UV protection for durability and long life.



Engineered tray-ends add extra strength, making them easier to carry and move.



Deep, continuous channels and 'level fit' wide ridges prevent water pooling and provide better stability for propagation media.

CAPACITY: 6L / 1.6GAL - **TRAY MEASUREMENTS:** 21.5" x 11.2" x 2.5" - **CASE MEASUREMENTS:** 22" x 14" x 13" - **UNITS PER CASE:** 50

ALSO AVAILABLE

Mondi Propagation Tray

1020 no holes



model #G150

Mondi Propagation Tray

1020 with holes



model #G155

Mondi Mini-Greenhouse

7" with Easy Vents

- A professional propagation dome for starting seeds or cuttings
- Constructed from proprietary food-grade materials that do not off gas and kill plants



model #G100

Mondi Mini-Greenhouse

7" No Vents

- Perfectly fitted for standard trays, to create a tight seal and reduce moisture loss



model #G105

Mondi Mini-Greenhouse

4" with Easy Vents

- Temperature and humidity controlled by two adjustable vents for better growing results



model #G110

Mondi Mini-Greenhouse

4" No Vents

- Heavy duty plastic maximizes light penetration with lasting durability



model #G115

For a complete product line visit: www.mondiproducts.com

Hydrofarm: The Leader in Design and Manufacturing Quality

Hydrofarm's dedication to manufacturing quality is well established. For nearly four decades we've been committed to bringing you the highest-quality indoor gardening products in the industry. Our uncompromising commitment to excellence governs every step of product development, from concept and design to final production, helping to ensure that the product you hold in your hands performs as advertised reliably, while giving great value.

Engineering Collaboration

Our team of in-house engineers collaborates with factory engineers during each step of the design process, consulting certification testing laboratories when necessary. We then embark on the sampling phase, reviewing and refining each sample until the final product reliably meets our exacting standards. Only then can production begin.

Manufacturing Quality

Hydrofarm conducts the most comprehensive Quality Assurance inspection process in the industry! Our unique approach employs a multidisciplinary team of QA specialists who visit the factories to oversee initial production. Following strict protocols, the team reviews each product to ensure that Hydrofarm's rigorous electrical, technical, and material specifications are being upheld in every unit that comes off the line.

Constant Evolution

We utilize a system of internal feedback at all levels, from minor packaging improvements to major product evolutions. That's how we continue to grow, evolve, and prove our value and service offering. Considering all of the above, it's no wonder that Hydrofarm continues to be the indoor horticultural product industry's leader in design and manufacturing quality.



Our dedicated technical teams do not rest until every detail has been scrutinized.

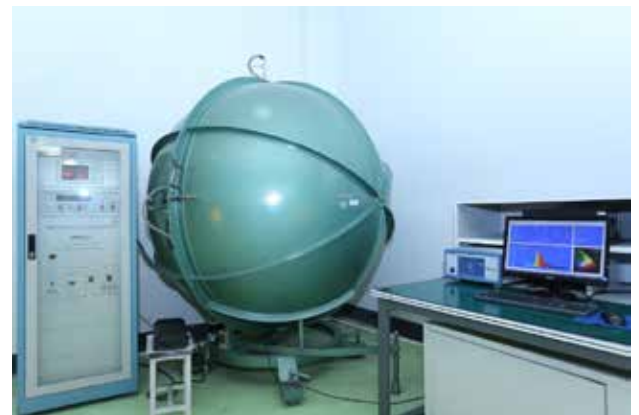

Our lighting test laboratory utilizes cutting-edge equipment like this integrating sphere with goniophotometer.