

INTEX®

Summer

2019
COLLECTION





optima.ru



2019

8	SWIM TRAINERS	44	PLAYCENTERS	104	IN TOYZ*
11	POOL TOYS & FLOATS	55	SWIMMING POOLS	112	AIR PUMPS
31	SPORT LOUNGES	72	AQUAFLOW™	116	COMMITMENT TO EXCELLENCE
36	NOVELTIES & GAMES	82	BOATS	118	PRODUCT LOCATOR TABLE

About Us



Intex Trading B.V., The Netherlands

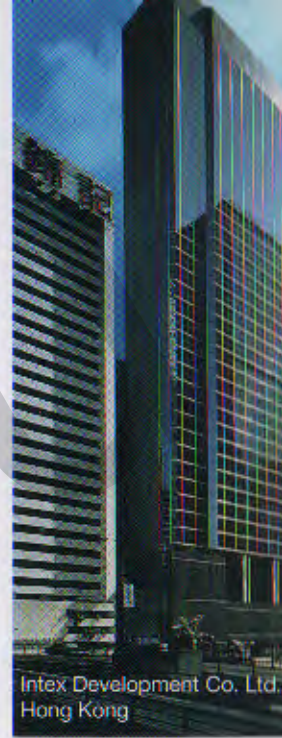

Intex Development Co. Ltd.
Hong Kong



Intex Manufacturing and Distribution Complex, Xiamen, China

Intex Recreation Corp, Long Beach, CA, USA



Intex Service (France) S.A.S., France



Intex Administration Building
Landscape, Xiamen, China





The Intex Family of companies is dedicated to developing and manufacturing the highest quality products that not only provide the best value in price, but are innovative, fun and exciting. Backed by excellent Customer Service, Intex also provides first-rate after sales support. The 100+ independently owned and locally operated companies that make up the Intex Family all embrace this commitment to quality, service and price and are committed to working together to ensure the satisfaction of the families and individuals in countries across the globe who enjoy these products. This has become the hallmark of Intex around the world.

As a true industry leader, Intex boasts state of the art factories, trained and motivated people, products that meet rigorous testing requirements, and a Customer Service organization that will go extra lengths to ensure our customers are satisfied and happy with their purchases.

When you purchase an Intex product you can be confident that you are buying the best product, at the best price, backed by the best Customer Service organization in the industry. Intex is committed to delivering top quality products at a great value with the backing of a responsive Customer Service organization. Intex's Wet Set[®] line offers hundreds of backyard, pool and lake inflatables designed for every budget and age group. With products ranging from colorful and fun beach balls to floating islands for you and your friends to lounge on, no summer is complete without them.

For boating enthusiasts, we offer a line of boats that are perfect for one person relaxing in a pool on a lazy afternoon, to 5-person boats designed for serious camping trips. Ask your Intex representative for any of our product catalogs — we are confident that you will agree that Intex's product line is unmatched in meeting your needs.





Packaging

Packaging creates a powerful impact in the world of consumer shopping. That is why here at Intex, we strive to deliver the most attractive and unique package design that communicates and promotes our brand image – by delivering maximum shelf impact at the store level. We make the package a part of the experience.

Throughout our multiple lines of products across different categories, attractive design and outstanding high quality images offered by each packaging provide a competitive edge at the retail level. Our packages are designed to enhance shelf appeal and stimulate sales, as part of our strategy to ensure a successful sales season.



Brand Partners

From the Movie
Disney FROZEN

Accompany Anna and Elsa on their enchanting adventures with these magical summer inflatables!
 ©Disney
 Visit the Disney Website at www.disney.com

Disney
Winnie the Pooh

Anyone who gets to know Winnie the Pooh and his friends quickly comes to love them.
 ©Disney
 Based on the "Winnie the Pooh" works by A.A. Milne and E.H. Shepard.



Hit the fast lane with Lightning McQueen — everyone's favorite race car will have you speeding through summer!
 ©Disney/Pixar



Enjoy a real life "bull-riding" experience with the Intex PBR Inflatabull!
 ©PBR



Swim Trainers

POOL SCHOOL™

A three-step progressive swim trainer program focused on safety awareness to help kids develop water confidence and improve swimming skills.



56587EU/EP
DELUXE BABY FLOAT
POOL SCHOOL™ STEP 1

- 31" x 31" (79cm x 79cm)
- 12ga (0.3mm) vinyl
- Large square ring for stability
- Diaper style seat
- 4 air chambers
- Repair patch
- Pegable box
- 33 lb (15 kg) maximum weight limit
- 12 ea, 22.3 lb (10.1 kg)

AGE 1-2



58860EU/EP
DELUXE SWIM VEST
POOL SCHOOL™ STEP 2

- 10ga (0.25mm) vinyl
- 3 air chambers including an inflatable collar
- 2 quick release adjustment buckles
- Pegable box
- 24 ea, 15.9 lb (7.2 kg)

AGE 3-6



58231EU/EP
DELUXE SWIM RING
POOL SCHOOL™ STEP 2

- 20" (51cm) diameter
- 10ga (0.25mm) vinyl
- 2 air chambers with double valves
- Pegable box
- 24 ea, 10.2 lb (4.6 kg)

AGE 3-6



56643EU/EP
ROLL-UP ARM BANDS
POOL SCHOOL™ STEP 3

- 8" x 6" (20cm x 15cm)
- 10ga (0.25mm) vinyl
- 2 air chambers each
- Pegable box
- 36 pairs, 12.8 lb (5.8 kg)

AGE 3-6

58167EU/EP
KICKBOARD
POOL SCHOOL™ STEP 3

- 31" x 30" (79cm x 76cm)
- 10ga (0.25mm) vinyl
- Clear center section with I-beam construction
- Heavy duty handles
- 2 air chambers
- Repair patch
- Pegable box
- 12 ea, 13.6 lb (6.2 kg)

AGE 3+



59640NP/EU/EP
ARM BANDS

- 7½" x 7½" (19cm x 19cm)
 - 8ga (0.20mm) vinyl
 - 2 air chambers each
- 72 pairs, 16.9 lb (7.7 kg)

AGE 3-6



59642NP/EU/EP
LARGE ARM BANDS

- 10" x 6½" (25cm x 17cm)
 - 8ga (0.20mm) vinyl
 - 2 air chambers each
- 36 pairs, 9.2 lb (4.2 kg)

AGE 6-12



58671NP/EU/EP
DELUXE SWIM VEST

- 19½" x 18½" (50cm x 47cm)
 - 10ga (0.25mm) vinyl
 - 3 air chambers including an inflatable collar
 - 2 quick release adjustment buckles
- Pegable box
24 ea, 16.1 lb (7.3 kg)

AGE 3-6



59650NP/EP
SEA BUDDY ARM BANDS

- 7½" x 7½" (19cm x 19cm)
 - 8ga (0.20mm) vinyl
 - 2 air chambers each
- 36 pairs, 8.7 lb (4.0 kg)

Not available in Europe

AGE 3-6



58652NP/EU/EP
TROPICAL BUDDIES ARM BANDS

- 9" x 6" (23cm x 15cm)
 - 8ga (0.20mm) vinyl
 - 2 air chambers each
- Pegable box
36 pairs, 9.4 lb (4.3 kg)

AGE 3-6



59661NP/EP
TROPICAL BUDDIES SWIM VEST

- 16" x 12" (41cm x 30cm)
 - 10ga (0.25mm) vinyl
 - 3 air chambers
 - 2 quick release adjustment buckles
- 24 ea, 11.1 lb (5.0 kg)
- Not available in Europe

AGE 3-5



58642NP/EU/EP
DELUXE ARM BANDS

- 9" x 6" (23cm x 15cm)
 - 10ga (0.25mm) vinyl
 - 2 air chambers each
- Pegable box
36 pairs, 10.8 lb (4.9 kg)

AGE 3-6



58641NP/EU/EP
LARGE DELUXE ARM BANDS

- 12" x 6" (30cm x 15cm)
 - 10ga (0.25mm) vinyl
 - 2 air chambers each
- Pegable box
36 pairs, 12.4 lb (5.7 kg)

AGE 6-12

Pool Toys & Floats



Dive ToyzTM

55503/E

UNDERWATER FUN BALLS

- Soft neoprene material for streamers
 - Floating streamers create extra fun
 - 3 bright colors in one set
- 12 ea, 4.4 lb (2.0 kg)

AGE 6+



55504/E

UNDERWATER PLAY STICKS

- Soft, flexible material for safety
 - Sticks stand upright on pool bottom
 - 5 bright colors in one set
- 12 ea, 8.2 lb (3.7 kg)

AGE 6+

55507/E

UNDERWATER FISH RINGS

- 4 fun bright colored fish in one set: Blue, Green, Red and Yellow
 - Soft flexible material for safety
 - Rings stand upright on pool bottom
- 12 ea, 6.5 lb (3.0 kg)

AGE 6+



Puff'n'Play™



58590NP/EP

PUFF 'N PLAY™ WATER TOYS

- Teddy the Tropical Fish
 - Dakota the Duck
 - Wayne the Whale
 - Fred the Flamingo
 - Pegable box
- 36 ca, asst, 4.6 lb (2.1 kg)

AGE 2+



59574NP/EP

MY BABY FLOAT™

- 26½" (67cm) diameter
- 10ga (0.25mm) vinyl
- Large ring with smaller inner ring for stability
- Pillow backrest
- Diaper style seat
- 2 air chambers
- 33 lb (15 kg) maximum weight limit
- 24 ea. 18.6 lb (8.5 kg)
- Not available in Europe

AGE 1-2



56585EU/EP

MY BABY FLOAT™

- 27½" (70cm) diameter
- 12ga (0.30mm) vinyl
- Large ring with smaller inner ring for stability
- Pillow backrest
- Diaper style seat
- 4 air chambers
- 25 lb (11 kg) maximum weight limit
- Repair patch
- Pegable box
- 12 ea. 17.1 lb (7.8 kg)

AGE 6-12 MONTHS

56588EU/EP

BABY FLOAT™

- 30" (76cm) diameter
- 12ga (0.30mm) vinyl
- Diaper style seat
- 4 air chambers
- 33 lb (15 kg) maximum weight limit
- Repair patch
- Pegable box
- 12 ea. 19.7 lb (9.0 kg)

AGE 1-2



Baby Floats

56590NP/EP

MY FIRST SWIM FLOAT™

- 46" x 29½" (1.17m x 75cm)
- 10 ga (0.25mm) Vinyl
- Inflatable leaf shade
- Smooth leg holes inside smaller ring for baby
- 3 air chambers for added safety
- Smaller ring weight capacity: 33lb (15kg)
- Repair patch
- Shelf box
- 12 ea. 21.2 lb (9.7 kg)
- Not available in Europe

AGE 1-2



56581NP/EP

KIDDIE FLOAT

- 32" x 26" (81cm x 66cm)
- 10ga (0.25mm) vinyl
- 2 air chambers
- Smooth leg holes
- Inflatable sunshade
- 3 play balls in handle bar (1 rattle ball, 2 plastic balls)
- Shelf box
- 33 lb (15 kg) maximum weight limit
12 ea, 16.9 lb (7.7 kg)
U.S. Patent No. 6,749,474
Not available in Europe

AGE 1-2



56584NP/EP FROGGY FRIEND SHADED BABY FLOAT

- 47" x 31" (1.19m x 79cm)
- 10ga (0.25mm) vinyl
- 3 air chambers
- Friendly frog character
- Inflatable leaf sunshade for added sun protection
- Smooth leg holes for a comfortable feel
- Shelf box
- 33lb (15kg) maximum weight limit
12 ea, 16.0 lb (7.3 kg)
Not available in Europe

AGE 1-2



NEW

59586NP/EP

KIDDIE FLOATS

- Lil' Construction Truck, Lil' Army Plane, Lil' Fire Engine
- 8ga (0.20mm) bodies;
- 10ga (0.25mm) seats
- Smooth leg holes
- Repair patch
- 33lb (15kg) maximum weight limit
24 ea, asst, 17.5 lb (8.0 kg)
Not available in Europe

Lil' Construction Truck:
34" x 23" (86cm x 58cm)
Lil' Army Plane:
35" x 30" (89cm x 76cm)
Lil' Fire Engine:
29" x 23" (74cm x 58cm)

AGE 1-2



NEW

Beach Balls



59030NP/EP
GLOSSY PANEL BALL

- 24" (61cm) diameter
- 7ga (0.18mm) vinyl
- 36 ea, 11.0 lb (5.0 kg)

AGE 3+



59020NP/EP
GLOSSY PANEL BALL

- 20" (51cm) diameter
- 7ga (0.18mm) vinyl
- 36 ea, 8.5 lb (3.9 kg)

AGE 3+



NEW
graphics

NEW
59040NP/EP
LIVELY PRINT BALLS

- 20" (51cm) diameter
- 7ga (0.18mm) vinyl
- Novelty Delights, Octopus & Friends, and Coral Reef Fish designs
- 36 ea, asst, 8.4 lb (3.8 kg)

AGE 3+



59065NP/EP
JUMBO BALL

- 42" (1.07m) diameter
- 9ga (0.23mm) vinyl
- Fresh, fun, multi-colored dot design
- Repair patch
- 24 ea, 25.8 lb (11.7 kg)

AGE 3+

Pool Floats



59380NP/EP

POOL CRUISERS

- Race car, Fish and Plane assortment
- 8ga (0.20mm) vinyl
- Repair patch
- 59 lb (27 kg) maximum weight limit
- 24 ea, asst, 23.9 lb (10.9 kg)

Race car: 42" x 27" (1.07m x 69cm)
 Fish: 46" x 30" (1.17m x 76cm)
 Plane: 47" x 45" (1.19m x 1.14m)

AGE 3-6

59570NP/EP

SEE-ME-SIT POOL RIDERS

- Duck, Bunny and Turtle assortment
- Adorable kid-friendly characters
- 10ga (0.25mm) vinyl
- 2 air chambers
- Smooth leg holes
- Repair patch
- 50 lb (23 kg) maximum weight limit
- 12 ea, asst, 12.9 lb (5.9 kg)

AGE 3-4

Not available in Europe

Duck: 28" x 23" (71cm x 58cm)
 Bunny: 32" x 23" (81cm x 58cm)
 Turtle: 30" x 23" (76cm x 58cm)

58165NP/EP

JOY RIDER

- 44" x 24½" (1.12m x 62cm)
- 10ga (0.25mm) vinyl
- Cool graphics
- 2 handles for stability
- 2 air chambers
- Repair patch
- Shelf box
- 12 ea, asst, 17.9 lb (8.1 kg)

AGE 6+

Swim Rings



NEW

59220NP/EP ANIMAL SPLIT RINGS

- Duck, Flamingo, Penguin assortment
- 8ga (0.20mm) vinyl
- 36 ea, asst, 13.4 lb (6.1 kg)

Duck: 24½" x 22½" (62cm x 57cm)
Flamingo: 30" x 21½" (76cm x 55cm)
Penguin: 25" x 25" (64cm x 64cm)

AGE 3-6



NEW design



58221NP/EP BIG ANIMAL RINGS

- Playful Lion, Alligator and Toucan jungle animals
- 10ga (0.25mm) vinyl
- Pegable box
- 36 ea, asst, 23.5 lb (10.7 kg)

Lion: 28½" x 26" (72cm x 66cm)
Alligator: 28" x 22" (71cm x 56cm)
Toucan: 35" x 22" (89cm x 56cm)

AGE 3-6



NEW graphics

NEW

59230NP/EP LIVELY PRINT SWIM RINGS

- 20" (51cm) diameter
- 7ga (0.18mm) vinyl
- Coral Reef Fish, Novelty Delights, and Pink Octopus and Friends designs
- Modern clear top
- 36 ea, asst, 8.3 lb (3.8 kg)

AGE 3-6

NEW

59241NP/EP LIVELY PRINT SWIM RINGS

- 24" (61cm) diameter
- 7ga (0.18mm) vinyl
- Coral Reef Fish, Novelty Delights, and Pink Octopus and Friends designs
- Modern clear top
- 36 ea, asst, 11.2 lb (5.1 kg)

AGE 6-10

59242NP/EP

TRANSPARENT RINGS

24" (61cm) diameter
7ga (0.18mm) vinyl
3 assorted patterns printed
on clear vinyl
36 ea, asst, 10.9 lb (5.0 kg)

AGE 6-10



59260NP/EP

TRANSPARENT TUBES

30" (76cm) diameter
8ga (0.20mm) vinyl
Transparent aqua, lime and
pink assortment
24 ea, asst, 11.7 lb (5.3 kg)

AGE 8+



59258NP/EP

HI-GLOSS TUBES

30" (76cm) diameter
8ga (0.20mm) vinyl
Pink, yellow and orange neon colors
2 heavy duty handles for added
stability
24 ea, asst, 16.3 lb (7.4 kg)

AGE 8+

59262NP/EP

NEON FROST TUBES

- 36" (91cm) diameter
 - 9ga (0.23mm) vinyl
 - Yellow, orange and pink neon frost colors
- 24 ea, asst, 18.5 lb (8.4 kg)

AGE 9+



58263NP/EP

TRANSPARENT TUBES

- 38" (97cm) diameter
 - 10ga (0.25mm) vinyl
 - 2 heavy duty handles
 - Bright tropical designs
- Shelf box
12 ea, asst, 15.6 lb (7.1 kg)

AGE 9+



NEW

59251NP/EP

CLEAR COLOR TUBES

- 36" (91cm) diameter
 - 9ga (0.23mm) vinyl
 - Assorted blue, purple and orange floral graphics with white bottom
- 24 ea, asst, 18.9 lb (8.6 kg)

AGE 9+



NEW
graphics

Swim Tubes



58883NP/EP

SIT 'N LOUNGE™

- 47" (1.19m) diameter
- 12ga (0.30mm) vinyl
- Clear top with blue and green bottom
- 2 air chambers
- 2 heavy duty handles
- One cup holder
- Repair patch
- Shelf box

AGE 8+



59256NP/EP

STARGAZE TUBES

- 36" (91cm) diameter
- 9ga (0.23mm) vinyl
- Bright star patterns
- Clear top
- Pink, blue and purple bottom
- 2 heavy duty handles for added stability

AGE 9+





58202EU/EP
COLOR WHIRL TUBE

- 48" (1.22m) diameter
 - 12ga (0.30mm) vinyl
 - 2 air chambers
 - 2 heavy duty handles
 - Repair patch
 - Shelf box
- 6 ea, 18.0 lb (8.2 kg)

AGE 9+



59252NP/EP
GIANT TIRE TUBE

- 36" (91cm) diameter
 - 9ga (0.23mm) vinyl
 - "Radial" tread and sidewall
- 24 ea, 19.6 lb (8.9 kg)

AGE 9+



56268NP/EP
MONSTER TRUCK TUBE

- 45" (1.14m) diameter
- 10ga (0.25mm) vinyl
- "Radial" tread and sidewall
- 2 heavy duty handles
- Repair patch
- Shelf box
- 6 ea., 10.8 lb (4.9 kg)

Age 9+



68209NP/EP
RIVER RAT™

- 48" (1.22m) diameter
- Top 14ga (0.35mm); bottom 16ga (0.40mm)
- Bold stripes
- 2 air chambers with double valves
- All-around grab line
- Repair patch
- Shelf box
- 6 ea., 18.3 lb (8.3 kg)
- Not available in Europe

Age 9+

Mats & Lounges



NEW

59720NP/EP

FASHION MATS

- 72" x 27" (1.83m x 69cm)
- 7ga (0.18mm) vinyl
- 2 air chambers
- Coral Fish, Flamingo, Flower designs
- 24 ea, asst, 31.7 lb (14.4 kg)

59720EU

Same as 59720NP/EP except

- 8ga (0.20mm) vinyl
- Repair patch
- 24 ea, asst, 36.1 lb (16.4 kg)

NEW graphics



NEW graphics



59703NP/EP
ECONOMATS

- 72" x 27" (1.83m x 69cm)
- 6ga (0.15mm) vinyl
- Pink, green and blue assortment
- Matte finish
- 36 ea, asst, 38.3 lb (17.4 kg)

59703EU

- Same as 59703NP/EP except
- 8ga (0.20mm) vinyl
- 2 air chambers
- Repair patch
- 24 ea, asst, 35.8 lb (16.3 kg)



59717NP/EP
NEON FROST AIR MATS

- 72" x 30" (1.83m x 76cm)
- 8ga (0.20mm) vinyl
- Contoured pillow design and larger tubes
- Pink, orange and yellow neon frost colors
- Double-sealed edges
- 2 air chambers
- 24 ea, asst, 36.8 lb (16.7 kg)

59717EU

- Same as 59717NP/EP except
- Repair patch
- 24 ea, asst, 37.7 lb (17.1 kg)



58152EU/EP

SURF'S UP MATS

- 70" x 27" (1.78m x 69cm)
- Vintage surfboard & High Wave surfboard assortment
- Fiber-Tech™ interior structure for strength and stability
- 12ga (0.3mm) vinyl
- 2 air chambers
- Repair patch
- Shelf box
- 6 ea, asst, 17.0 lb (7.7 kg)



58807EU/EP
TOTE-N-FLOAT® WAVE MATS

- 90" x 34" (2.29m x 86cm)
- 10ga (0.25mm) vinyl
- Built-in pillow chamber
- Roll it up inflated and head for the pool!
- 2 air chambers
- Orange, yellow and pink color assortment
- Double-sealed edges
- Repair patch
- Shelf box
- 6 ea, asst, 17.1 lb (7.8 kg)

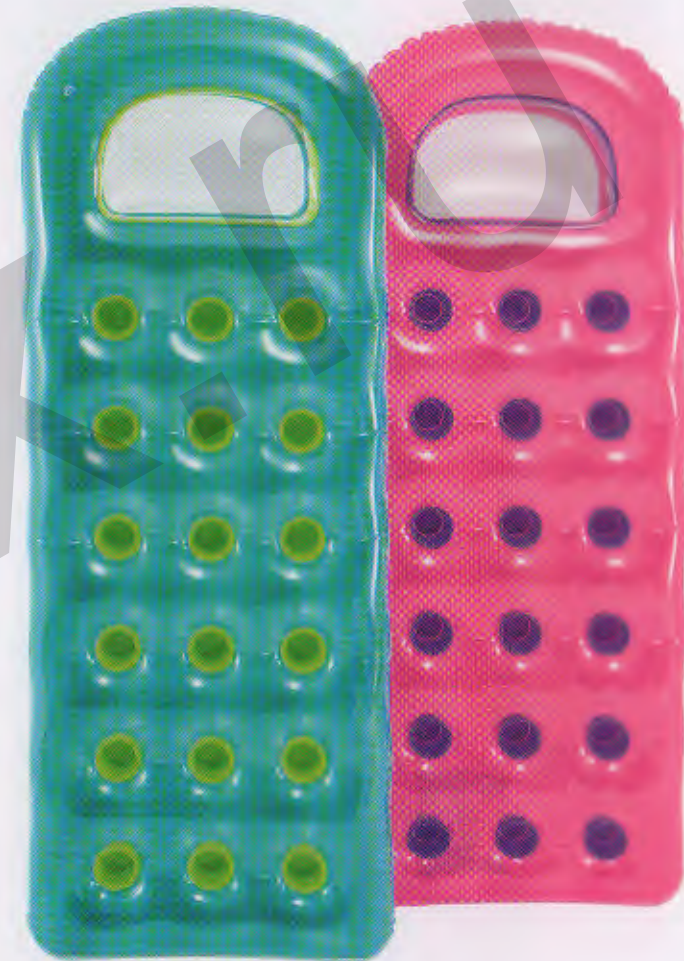

59895NP/EU/EP
18-POCKET SUNTANNER MATS

- 74" x 28" (1.88m x 71cm)
- 11ga (0.28mm) vinyl
- 2 air chambers
- Clear vinyl top with color pockets
- See-through window
- Coil-beam construction
- Contoured pillow for comfort
- Repair patch
- 12 ea, asst, 28.8 lb (13.1 kg)



NEW
color

NEW

58890NP/EU/EP

18-POCKET FASHION MATS

- 74" x 28" (1.88m x 71cm)
- 11ga (0.28mm) vinyl
- 2 air chambers
- Pillow for comfort
- Coil-beam construction
- I-beam pillow
- Repair patch
- Shelf box
- 6 ea, asst, 18.3 lb (8.3 kg)

58894EU/EP

18-POCKET SUNTANNER MAT

- 74" x 28" (1.88m x 71cm)
- 11ga (0.28mm) vinyl
- Clear top, reflective silver bottom
- 2 air chambers
- Coil-beam construction
- I-beam pillow
- Repair patch
- Shelf box
- 6 ea, asst, 18.3 lb (8.3 kg)



59894NP/EU/EP

18-POCKET SUNTANNER MATS

- 74" x 28" (1.88m x 71cm)
- 11ga (0.28mm) vinyl
- 2 air chambers
- Clear vinyl with color pockets
- See through window
- Coil beam construction
- Contoured pillow for comfort
- Repair patch
- 12 ea, asst, 28.6 lb (13.0 kg)



58802NP/EU/EP

KING KOOL™ LOUNGES

- 63" x 33½" (1.60m x 85cm)
- 12ga (0.30mm) vinyl
- Transparent top panels with multi-colored I-beams
- Pearlescent silver and blue assortment
- 2 air chambers
- Drink holder
- Armrests and backrest
- Repair patch
- Shelf box
- 6 ea, asst, 20.7 lb (9.4 kg)



58856EU/EP

ROCKIN' LOUNGE

- 74" x 39" (1.88m x 99cm)
- 16ga (0.40mm) vinyl
- Contoured design for added comfort
- 2 air chambers
- 1 cup holder
- Repair patch
- Shelf box
- 3 ea, 20.9 lb (9.5 kg)





56897EU/EP
DOUBLE LOUNGE MAT

- 78" x 63" (1.98m x 1.60m)
- 10ga (0.33mm) vinyl
- 2 air chambers
- Heavy duty vinyl construction
- Unique opposed design
- 2 standard size cup holders
- 2 built-in pillows
- Repair patch
- Shelf box
- 8 ea, 28.1 lb (12.8 kg)



58889EU/EP
PILLOW-BACK LOUNGES

- 54" x 48" (1.37m x 1.22m)
- 10ga (0.25mm) vinyl
- For pools, patios or home – great TV chair
- Clear top with orange or blue bottom
- 2 air chambers
- Repair patch
- Shelf box
- 6 ea, asst, 12.8 lb (5.8 kg)



58859NP/EU/EP
SIT 'N FLOAT

- 60" x 39" (1.52m x 99cm)
- 10ga (0.25mm) vinyl
- Unique design for extra fun
- Transparent top panel with yellow and green bottom
- 2 air chambers
- 2 heavy duty handles for stability
- Repair patch
- Shelf box
- 12 ea, asst, 26.4 lb (12.0 kg)



NEW

56800EU/EP

DOUBLE PILLOW-BACK LOUNGE

- 78" x 46" (1.98m x 1.17m)
- 12ga (0.30mm) vinyl
- 2 person lounge
- Clear top with blue bottom
- Built-in backrests
- Two drink holders
- Two heavy duty handles
- Repair patch
- Shelf box
- 6 ea, 29.9 lb (13.6 kg)



NEW
item

Sport Lounges



58854EU/EP

RIVER RUN™ CONNECT LOUNGE

- 51" x 49½" (1.30m x 1.26m)
 - Comfortable backrest
 - Mesh bottom
 - Built-in cup holder
 - Easy-to-use connectors* to fasten it to an Intex Cooler or additional River Runs
 - Durable handles
 - 2 air chambers for added safety
 - Repair patch
 - Shelf box
- 4 ea., 22.5 lb (10.2 kg)
U.S. Patent No. D747,425, D746,934



U.S. Patent No. D759,180



58837EU/EP

RIVER RUN™ 2

- 95½" x 62" (2.43m x 1.57m)
 - 18ga (0.45mm) vinyl
 - Mesh bottom keeps you cool
 - Built-in backrest for easy cruising
 - Large built-in cooler with lid
 - Easy-to-use connectors*
 - 5 air chambers
 - 2 heavy duty handles
 - 2 cup holders
 - All-around grab rope
 - Repair patch
 - Shelf box
- 3 ea., 37.2 lb (16.9 kg)



58821NP/EP

MEGA CHILL 2

- 48" x 38" (1.22m x 97cm)
 - 16ga (0.40mm) vinyl
 - Removable ice chest
 - Holds up to 72 soda cans plus ice
 - Use as a floating base for a cooler up to 48 quarts
 - 6 cup holders
 - Easy-to-use connectors* to fasten it to River Runs by Intex
 - 4 heavy duty handles
 - 3 air chambers
 - Repair patch
 - Shelf box
- 3 ea., 24.6 lb (11.2 kg)

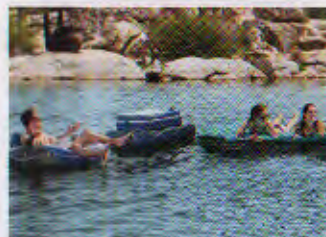

U.S. Patent No. D759,180

56822NP/EP

MEGA CHILL

- 35" (89cm) diameter
 - 16ga (0.40mm) vinyl
 - 5 built-in cup holders and 2 trays
 - Easy-to-use connectors* to fasten it to River Runs by Intex
 - Durable handles
 - 3 air chambers
 - Repair patch
 - Shelf box
- 6 ea., 20.3 lb (9.2 kg)



U.S. Patent No. D759,180



58825EU/EP

RIVER RUN[™] 1

- 53" (1.35m) diameter
 - 18ga (0.45mm) vinyl
 - Mesh bottom keeps you cool
 - Built in backrest for easy cruising
 - Easy-to-use connectors*
 - 2 air chambers
 - 2 heavy duty handles
 - 2 cup holders
 - All-around grab rope
 - Repair patch
 - Shelf box
- 6 ea, 34.7 lb (15.8 kg)

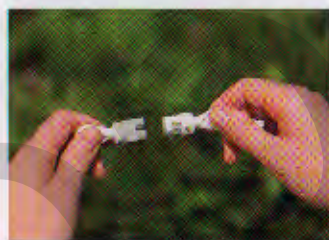

U.S. Patent No. D759,180

56825EU/EP
**RED RIVER RUN[™] 1
 FIRE EDITION**

- 53" (1.35m) diameter
 - 18ga (0.45mm) vinyl
 - Mesh bottom keeps you cool
 - Built-in backrest for easy cruising
 - Easy-to-use connectors*
 - 2 air chambers
 - 2 heavy duty handles
 - 2 cup holders
 - All-around grab rope
 - Repair patch
 - Shelf box
- 6 ea, 34.7 lb (15.8 kg)



58868EU/EP

FLOATING RECLINER LOUNGE

- 71" x 53" (1.80m x 1.35m)
- 18ga (0.45mm) vinyl
- Contoured design for added comfort
- 2 air chambers
- 2 cup holders
- 2 heavy duty handles
- Repair patch
- Shelf box
- 3 ea, 24.9 lb (11.3 kg)



58836EU

MESH MATS

- 70" x 37" (1.78m x 94cm)
- Mesh bottom for keeping cool
- Inflatable fabric-wrapped ring for durability and comfort
- Built-in pillow
- 2 air chambers
- Repair patch
- Shelf box
- 12 ea, asst, 16.6 lb (7.5 kg)
- Not available in USA





56841EU/EP

GIANT FLOATING MAT

- 114" x 89" (2.90m x 2.26m)
- 20ga (0.50mm) vinyl
- 2 air chambers for added safety
- 4 easy-to-use connectors
- Easy to inflate and deflate
- Folds small for storage
- Large space
- Repair patch
- Shelf box
- 2 ea, 40,3 lb (18.3 kg)

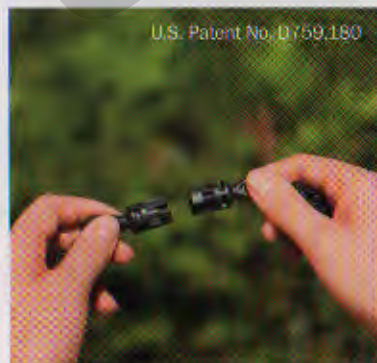
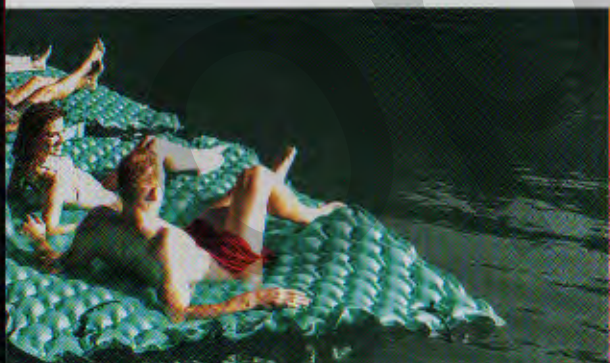

U.S. Patent No. D759,180



58292EU/EP

CANOPY ISLAND

- 78½" x 59" (1.99m x 1.50m) set up size
- 18ga (0.45mm) vinyl
- Detachable fabric sunshade
- 2 built-in cup holders
- All-around grab rope
- 2 air chambers for added safety
- Repair patch
- Shelf box
- 2 ea, 45.0 lb (20.5 kg)



Novelties &
Games





INFLATABULL™ USED UNDER LICENSE FROM DAVID DAL



© THE PROFESSIONAL BULL RIDERS
& IMG COLLEGE 1994-2010



56280EU/EP

INFLATABULL™

- 94" L x 77" W x 32" H (2.39m x 1.96m x 81cm) Inflated
 - 18ga (0.45mm) vinyl
 - 3 air chambers
 - 5 heavy duty handles to hold on to
 - Outer ring to ensure balance and safety
 - Repair patch
 - Shelf box
- 2ea. 29.7 lb (13.5 kg)

AGE 9+



PHOTO EYE



57555NP/EP
**REALISTIC SEA TURTLE
 RIDE-ON**

- 75" x 67" (1.91m x 1.70m)
- 12ga (0.30mm) vinyl
- 2 air chambers
- Hop on the world's friendliest sea turtle for a comfortable and fun ride!
- 2 heavy duty handles
- Repair patch
- Shelf box
- 4 ea. 18.7 lb (8.5 kg)

AGE 3+



57525NP/EP
**GREAT WHITE SHARK
 RIDE-ON**

- 68" x 42" (1.73m x 1.07m)
- 10ga (0.25mm) vinyl
- Innovative photo-realistic printing
- 2 heavy duty handles
- Repair patch
- Shelf box
- 6 ea. 11.7 lb (5.3 kg)

AGE 3+



57551NP/EP
**REALISTIC GATOR
 RIDE-ON**

- 67" x 34" (1.70m x 86cm)
- 10ga (0.25mm) vinyl
- 2 heavy duty handles
- Repair patch
- Shelf box
- 6 ea. 10.6 lb (4.8 kg)

AGE 3+





57550NP/EP
STINGRAY RIDE-ON

- 74" x 57" (1.88m x 1.45m)
- 10ga (0.25mm) vinyl
- Innovative photo-realistic printing (on top and bottom)
- 2 heavy duty handles
- Repair patch
- Shelf box
- 6 ea., 15.2 lb (6.9 kg)

AGE 3+

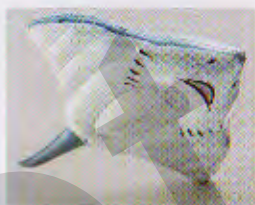

U.S. Patent No. D722,667



NEW

57533NP/EP
LOBSTER RIDE-ON

- 84" x 54" (2.13m x 1.37m)
- 12ga (0.30mm) vinyl
- Innovative photo-realistic printing
- 4 heavy duty handles
- Repair patch
- Shelf box
- 6 ea., 27.4 lb (12.5 kg)

AGE 3+



NEW
Item

Realistic
Ride-ons!



57537NP/EP

**WATER GUN PLANE
RIDE-ONS**

- 52" x 51" (1.32m x 1.30m)
- 10ga (0.25mm) vinyl
- Propeller style plane design
- Includes a toy water gun
- Wide base for extra support
- Handle for added stability
- Repair patch
- Shelf box
- 6 ea, asst, 13.5 lb (6.1 kg)

AGE 3+



57520NP/EP

**WAVE RIDER
RIDE-ON**

- 46" x 30½" (1.17m x 77cm)
- 10ga (0.25mm) vinyl
- Bright, bold, and sleek design
- Wide base for extra stability
- 1 heavy duty handle
- Repair patch
- Shelf box
- 6 ea, 11.5 lb (5.2 kg)

AGE 3+



57524NP/EP

LIL' SEA TURTLE RIDE-ON

- 59" x 50" (1.50m x 1.27m)
- 10ga (0.25mm) vinyl
- Extra stable design
- 2 heavy duty handles
- Repair patch
- Shelf box
- 6 ea, 15.9 lb (7.2 kg)

AGE 3+

58561NP/EP
WHALE RIDE-ON

- 76" x 47" (1.93m x 1.19m)
- 12ga (0.30mm) vinyl
- 2 air chambers
- 2 heavy duty handles
- Repair patch
- Shelf box
- 6 ea, 20.7 lb (9.4 kg)

AGE 3+

58523NP/EP
LIL' WHALE RIDE-ON

- 60" x 45" (1.52m x 1.14m)
- 10ga (0.25mm) vinyl
- 2 heavy duty handles
- Repair patch
- Shelf box
- 6 ea, 14.0 lb (6.4 kg)

AGE 3+



58546NP/EP
LIL' GATOR RIDE-ON

- Smaller version of #58562
- 66" x 34" (1.68m x 86cm)
- 10ga (0.25mm) vinyl
- 1 heavy duty handle
- Repair patch
- Shelf box
- 12 ea, 19.9 lb (9.1 kg)

AGE 3+

58562NP/EP
GIANT GATOR RIDE-ON

- 80" x 45" (2.03m x 1.14m)
- 12ga (0.30mm) vinyl
- 2 air chambers
- 4 heavy duty handles
- Repair patch
- Shelf box
- 6 ea, 19.3 lb (8.8 kg)

AGE 3+



58535NP/EP
LIL' DOLPHIN RIDE-ON

- 69" x 26" (1.75m x 66cm)
- 10ga (0.25mm) vinyl
- 2 heavy duty handles
- Repair patch
- Shelf box
- 6 ea, 10.5 lb (4.8 kg)

AGE 3+



NEW
Item

NEW
Item

56514NP/EP
PRINCESS CARRIAGE

- 57" L x 53" W x 41" H (1.45m x 1.35m x 1.04m) inflated
- Horse inflated size: 49" L x 23" W x 26" H (1.24m x 58cm x 66cm)
- 12ga (0.30mm) vinyl
- Enchanting pearlescent pink carriage
- Comes with its own friendly horse
- Suitable for both indoors and outdoors
- Repair patch
- Shelf box
2 ea, 26.6 lb (12.1 kg)

AGE 3+



58507NP/EP

FUN GOALS GAME

- 55" L x 35" W x 32" H (1.40m x 89cm x 81cm) inflated
- 10ga (0.25mm) vinyl with 7ga (0.18mm) ball
- Includes anchor bags and an inflatable ball
- Goal base has grommets for anchor weights if desired
- Repair patch
- Shelf box
6 ea, 25.1 lb (11.4 kg)

AGE 6+



58504NP/EP

FLOATING HOOPS

- 26½" x 21½" (67cm x 55cm) inflated
- 10 ga (0.25mm) vinyl with 7ga (0.18mm) ball
- Inflatable basketball
- Inflatable hoop
- Fun, bright color combination
- Repair patch
- Shelf box
- 12 ea, 14.7 lb (6.7 kg)

AGE 3+



56508NP/EP

POOL VOLLEYBALL GAME

- 94" L x 25" W x 36" H (2.39m x 64cm x 91cm) inflated
- 10ga (0.25mm) vinyl with 7ga (0.18mm) ball
- Includes inflatable volleyball
- Includes grommet bags to add weights and anchor the pole bases
- Repair patch
- Shelf box
- 6 ea, 17.0 lb (7.7 kg)

AGE 6+



58294EU/EP

ISLAND WITH SLIDE

- 110" L x 68" W x 48" H (2.79m x 1.73m x 1.22m) inflated
- 15ga (0.38mm) island and slide; 10ga (0.25mm) sunshade and noodles
- 6 heavy duty handles
- Removable side noodles
- Detached slide
- Make your day at the pool even more exciting with this Island with Slide Float and removable sides
- Landing pad
- 220 lb (100 kg) maximum weight limit
- Repair patch
- Shelf box
- 1 ea, 23.8 lb (10.8 kg)

AGE 9+



Play Centers





NEW

57161NP/EP
JUNGLE ADVENTURE PLAY CENTER

- 8'5" L x 7'1" W x 2'9" H (2.57m x 2.16m x 84cm) inflated
- 12ga (0.30mm) vinyl
- Two pools in one: small pool and larger pool
- Includes water slide, inflatable palm trees, flamingo, monkey, ring toss game and 5 balls to fit the wall
- Landing mat for extra padding
- Includes control valve to adjust water flow
- Drain plug in pool floor
- Small pool equipped with overflow drain hole to fill to no more than 4 1/2" (11cm) water height for younger children 15 gal (57L)
- Larger pool capacity 8' (20cm) of wall height: 130gal (493L)
- 178 lb (81 kg) maximum weight limit
- Repair patch
- Shelf box
 2 ea, 31.1 lb (14.2 kg)

57161NP

AGE 3+

57161EP

AGE 2+

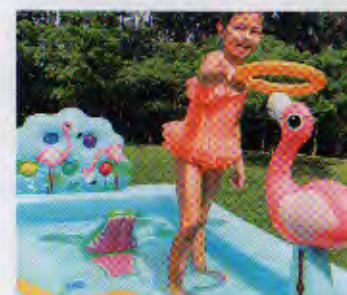

NEW
 Item



NEW

57162NP/EP

FISHING FUN PLAY CENTER

- 7'2" L x 6'2" W x 3'3" H (2.18m x 1.88m x 99cm) inflated
- 11ga (0.28mm) vinyl
- Palm tree sprayer attaches to garden hose
- Includes inflatable fishing rod, two fish, 6 balls to fit the wall
- Landing mat for extra padding
- Capacity 5¼" (13cm) of wall height: 48 gal (182L)
- 178 lb (81 kg) maximum weight limit
- Drain plug
- Repair patch
- Shelf box
2 ea, 19.1 lb (8.7 kg)

57162NP

AGE 3+

57162EP

AGE 2+



NEW
item



NEW
Item

NEW
Item

57160NP/EP

HAPPY DINO PLAY CENTER

- 8'6" L x 5'5" W x 3'6" H (2.59m x 1.65m x 1.07m) inflated
- 12ga (0.30mm) vinyl
- Includes water slide and ring toss game
- Water sprayer spout attaches to water hose
- Landing mat for extra padding
- Wading pool fills to 5¼" (13cm) water height: 17 gal (65L)
- Main pool capacity 5¼" (13cm) of wall height: 45 gal (169L)
- 120 lb (54 kg) maximum weight limit
- Drain plug
- Repair patch
- Shelf box
- 2 ea., 26.4 lb (12.0 kg)

57160NP

AGE 3+

57160EP

AGE 2+





57149NP/EP
CANDY ZONE™ PLAY CENTER

- 9'8" L x 6'3" W x 4'3" H (2.95m x 1.91m x 1.30m) inflated
- 12ga (0.30mm) vinyl
- Includes waterslide, 2 lollipops, rails for balls rolling down and 6 balls
- Landing mat for extra padding
- Water sprayer attaches to garden hose to keep kids cool in the summer
- Large pool fills to: 5.5' (14cm) of wall height: 54gal (206L)
- Small pool fills to: 5.5' (14cm) of wall height: 44gal (168L)
- 178lb (81kg) maximum weight limit
- Drain plug
- Repair patch
- Shelf box
- 2 ea, 32.7 lb (14.9 kg)

57149NP
 AGE 3+

57149EP
 AGE 2+

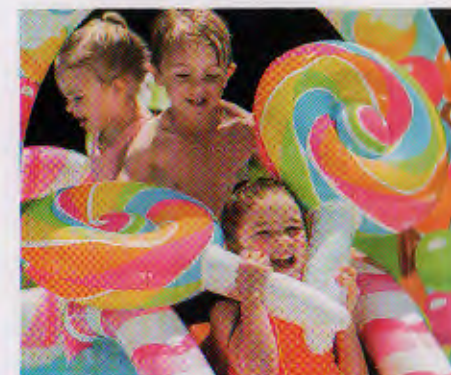



57129NP/EP
GATOR PLAY CENTER

- 6'6" L x 5'8" W x 2'11" H
- (2.03m x 1.73m x 89cm) inflated
- 11ga (0.28mm) vinyl
- Includes waterslide, 1 mushroom shade, gator, 2 fish, 1 baby duck and 1 fishing bucket
- Landing mat for extra padding
- Water sprayer attaches to garden hose to keep kids cool in the summer
- Capacity 5½" (14cm) of wall height: 48gal (180L)
- 120 lb (54 kg) maximum weight limit
- Drain plug
- Repair patch
- Shelf box
- 3 ea, 29.5 lb (13.4 kg)

57129NP
 AGE 3+

57129EP
 AGE 2+



57444NP/EP
DINOSAUR PLAY CENTER

- 8'2" L x 6'3" W x 3'7" H
(2.49m x 1.91m x 1.09m) inflated
- 10ga (0.25mm) vinyl
- Slide down the volcano and splash into the pool to feed the hungry dinosaur with colorful Fun Ballz™ (6 balls included)
- Attach a garden hose to keep kids cool with the palm tree sprayer and waterfall
- Water flow to palm tree sprayer and waterfall adjusts with control valve
- Landing mat for extra padding
- Drain plug in pool floor
- Capacity 6½" (16cm) of wall height: 72gal (272L)
- 178 lb (81 kg) maximum weight limit
- Repair patch
- Shelf box
- 2 ea, 25.2 lb (10.5 kg)

57444NP

AGE 3+

57444EP

AGE 2+





57453NP/EP

RAINBOW RING PLAY CENTER

- 9'9" L x 6'4" W x 4'5" H (2.97m x 1.93m x 1.35m) inflated
- 12ga (0.30mm) vinyl
- Includes waterslide, wading pool, water sprayer, ring toss game (with four inflatable rings), ball roller game and toss ball game (six 3 1/2" (8cm) Fun Ballz™ included)
- Water sprayer attaches to garden hose to keep kids cool in summer
- Landing mat for extra padding
- Wading pool fills to 8" (20cm) of wall height: 46 gal (175L)
- Main pool capacity 5 1/2" (14cm) of wall height: 54 gal (206L) for younger children
- 178 lb (81 kg) maximum weight limit
- Drain plug
- Repair patch
- Shelf box
- 2 ea, 34.3 lb (15.6 kg)

57453NP

AGE 3+

57453EP

AGE 2+



57135NP/EP
DINOLAND PLAY CENTER

- 10'11" L x 7'6" W x 3'8" H (3.33m x 2.29m x 1.12m) inflated
- 12ga (0.30mm) vinyl
- Comes ready for play with six 3½" (8cm) Fun Ballz™
- Moveable Dino Arch sprayer attaches to garden hose
- Slide and splash into the wading pool
- Jurassic fun with Dino Hoops and Volcanic Ball Roller games
- Landing mat for extra padding
- Capacity 5½" (14cm) of wall height: 77 gal (290L)
- 178 lb (81 kg) maximum weight limit
- Drain plug in pool floor
- Repair patch
- Shelf box
2 ea. 35.8 lb (16.3 kg)

57135NP

AGE 3+

57135EP

AGE 2+



58849NP/EP

WATER SLIDE

- 10'11" L x 6'9" W x 3'10" H
(3.33m x 2.06m x 1.17m)
- 20ga (0.50mm) vinyl
- Wave graphics
- Make a splash all summer long
- Attach garden hose for sprayers to wet the slide surface
- 5 air chambers
- 6 heavy duty handles
- 176 lb (80 kg) maximum weight limit
- Repair patch
- Shelf box

1 ea, 38.5 lb (17.5 kg)

AGE 6+





57159NP/EP
SURF 'N SLIDE

- 15'1" L x 5'6" W x 5'2" H (4.60m x 1.68m x 1.57m) inflated
- 16ga (0.4mm) vinyl
- 2 surf riders with heavy duty handles
- Landing mat for extra padding
- Attach garden hose for sprayers to wet the slide surface
- Endless summer fun!
- 176 lb (80 kg) maximum weight limit
- Repair patch
- Shelf box
- 1 ea. 33.5 lb (15.2 kg)

AGE 6+



Swimming Pools



Baby Pools



57100NP/EP
PLAY BOX POOLS

- 33½" x 33½" x 9"
(85cm x 85cm x 23cm) inflated
- 10ga (0.25mm) vinyl
- Soft inflatable floor
- Capacity 6½" (17cm) of wall height: 15 gal (57L)
- Repair patch
- Shelf box
- 6 ea, asst, 14.0 lb (6.4 kg)

AGE 1-3



57124NP/EP
LAZY SNAIL SHADE BABY POOL

- 57" x 40" W x 29" H
(1.45m x 1.02m x 74cm) inflated
- 10ga (0.25mm) vinyl
- Built-in sunshade provides partial protection from harsh sunlight
- Capacity 5½" (14cm) of wall height: 14 gal (53L)
- Repair patch
- Shelf box
- 6 ea, 24.9 lb (11.3 kg)

AGE 1-3



57106NP/EP
DINOSAUR 3-RING BABY POOL

- 24" x 8½" (61cm x 22cm) inflated
- 8ga (0.20mm) rings; 7ga (0.18mm) bottom vinyl
- Capacity 5½" (14cm) of wall height: 7 gal (28L)
- Repair patch
- Shelf box
- 12 ea, 11.4 lb (5.2 kg)

AGE 1-3



Printing on Frosted PVC

57107NP/EP
SUNSET GLOW BABY POOL

- 24" x 8½" (61cm x 22cm) inflated
- 8ga (0.20mm) rings; 7ga (0.18mm) floor
- Three rings
- Soft inflatable floor
- Capacity 5½" (14cm) of wall height: 7 gal (28L)
- Repair patch
- Shelf box
- 12 ea, 11.4 lb (5.2 kg)

AGE 1-3



58924NP/EP
SUNSET GLOW BABY POOL

- 34" x 10" (86cm x 25cm) inflated
- 8ga (0.20mm) rings; 7ga (0.18mm) floor
- Three rings
- Soft inflatable floor
- Capacity 6" (15cm) of wall height: 15 gal (56L)
- Repair patch
- Shelf box
- 6 ea, 9.0 lb (4.1 kg)

AGE 1-3

57104NP/EP
RAINBOW BABY POOL

- 34" x 10" (86cm x 25cm) inflated
- 8ga (0.20mm) rings; 7ga (0.18mm) floor
- Three rings
- Capacity 6" (15cm) of wall height: 17 gal (63L)
- Repair patch
- Shelf box
- 12 ea, 15.9 lb (7.2 kg)

AGE 1-3

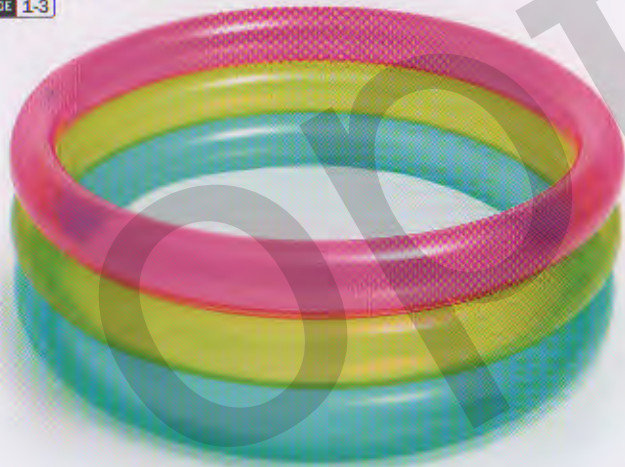

59409NP/EP
MY FIRST POOLS

- 24" x 6" (61cm x 15cm) inflated
- 8ga (0.20mm) rings; 7ga (0.18mm) floor
- Two rings
- Capacity 3" (8cm) of wall height: 4 gal (17L)
- Repair patch
- 36 ea, asst, 21.5 lb (9.8 kg)

AGE 1-3





57114NP/EP

MUSHROOM BABY POOL

- 40" x 35" (1.02m x 89cm) inflated
- 10ga (0.25mm) vinyl
- Baby's own pool with built-in mushroom sunshade
- A soft inflatable floor
- Capacity 5' (13cm) of wall height: 12 gal (45L)
- Repair patch
- Shelf box
- 6 ea, 20.2 lb (9.2 kg)

AGE 1-3

57122NP/EP

ROYAL CASTLE BABY POOL

- 48" x 48" (1.22m x 1.22m) inflated
- 10ga (0.25mm) vinyl
- Built-in sunshade
- Windows and large openings for added visibility and easy access
- Capacity 5' (13cm) of wall height: 20gal (74L)
- Repair patch
- Shelf box
- 6 ea, 33.9 lb (15.4 kg)

AGE 1-3





NEW
Item

NEW

57141NP/EP
RAINBOW CLOUD BABY POOL

- 56" L x 47" W x 33" H (1.42m x 1.19m x 84cm) inflated
- 10ga (0.25mm) vinyl
- Built-in sunshade
- Capacity 5 1/2' (13cm) of wall height: 22 gal (82L)
- Repair patch
- Shelf box
- 6 ea, 23.0 lb (10.4 kg)

AGE 1-3



57111NP/EP
FRIENDLY GOLDFISH BABY POOL

- 55" L x 49" W x 13 1/2" H (1.40m x 1.24m x 34cm) inflated
- 10ga (0.25mm) vinyl
- Goldfish design
- Capacity 4' (10cm) of wall height: 10 gal (36L)
- Repair patch
- Shelf box
- 6 ea, 11.8 lb (5.4 kg)

AGE 1-3



NEW

59460NP/EP

JUST SO FRUITY POOL SET

- Set includes #59421 inflatable pool with matching 20" (51cm) beach ball and 20" (51cm) swim ring
- 48" x 10" (1.22m x 25cm) inflated
- 8ga (0.20mm) rings; 7ga (0.18mm) floor
- 2 rings
- Capacity 7" (18cm) of wall height; 40 gal (150L)
- Repair patch 12 ea, 25.5 lb (11.6 kg)

AGE 2+

NEW
graphics



NEW

59421NP/EP

JUST SO FRUITY POOL

- 48" x 10" (1.22m x 25cm) inflated
- 8ga (0.20mm) rings; 7ga (0.18mm) floor
- 2 rings
- Capacity 7" (18cm) of wall height; 40 gal (150L)
- Repair patch 12 ea, 21.3 lb (9.7 kg)

AGE 2+

NEW
graphics



58439NP/EP
COOL DOTS POOL

- 58" x 13" (1.47m x 33cm) inflated
 - 8ga (0.20mm) rings;
 - 7ga (0.18mm) floor
 - Colorful dots
 - Capacity 9' (23cm) of wall height:
 - 87 gal (330L)
 - Repair patch
 - Shelf box
 - 6 ea, 19.0 lb (8.6 kg)
- AGE 2+

58449NP/EP
COOL DOTS POOL

- 66" x 18" (1.68m x 38cm) inflated
 - 9ga (0.23mm) rings;
 - 7ga (0.18mm) floor
 - Colorful dots
 - Capacity 11' (29cm) of wall height:
 - 154 gal (581L)
 - Repair patch
 - Shelf box
 - 6 ea, 28.6 lb (13.0 kg)
- AGE 2+

59469NP/EP
FISHBOWL POOL SET

- Set includes inflatable 52" x 11" (1.32m x 28cm) 3 ring pool with matching 20" (51cm) beach ball and 20" (51cm) swim ring
 - Repair patch
 - 12 ea, 31.6 lb (14.4 kg)
- AGE 2+



59431NP/EP
FISHBOWL POOL

- 52" x 11" (1.32m x 28cm) inflated
 - 8ga (0.20mm) rings;
 - 7ga (0.18mm) floor
 - 3 rings
 - Capacity 8½' (22cm) of wall height: 66gal (248L)
 - Repair patch
 - 12 ea, 27.1 lb (12.3 kg)
- AGE 2+



56441NP/EP

SUNSET GLOW POOL

- 66" x 18" (1.68m x 46cm) inflated
- 9ga (0.23mm) rings with 7ga (0.18mm) floor
- 4 equal rings
- Capacity 14½" (37cm) of wall height: 206 gal (780L)
- Drain plug
- Repair patch
- Shelf box, 6 ea, 33.8 lb (15.4 kg)

AGE 3+



57412NP/EP

SUNSET GLOW POOL

- 45" x 10" (1.14m x 25cm) inflated
- 8ga (0.20mm) rings; 7ga (0.18mm) floor
- 3 rings, soft inflatable floor
- Capacity 7" (18cm) of wall height: 35 gal (131L), Repair patch
- Shelf box, 6 ea, 15.2 lb (6.9 kg)

AGE 2+

57422NP/EP

SUNSET GLOW POOL

- 58" x 13" (1.47m x 33cm) inflated
- 8ga (0.20mm) rings; 7ga (0.18mm) floor
- 3 rings, soft inflatable floor
- Capacity 9½" (24cm) of wall height: 73 gal (275L), Repair patch
- Shelf box, 6 ea, 23.3 lb (10.6 kg)

AGE 2+

NEW

58448NP/EP

WATERMELON POOL

- 66" x 15" (1.68m x 38cm) inflated
- 9ga (0.23mm) vinyl with 7ga (0.18mm) floor
- 3 rings
- Capacity 11½" (29cm) of wall height: 154 gal (581L)
- Colorful watermelon print
- Repair patch
- Shelf box, 6 ea, 28.6 lb (13.0 kg)

AGE 2+



57403NP/EP

RECTANGULAR POOL

- 65½" L x 39½" W x 11" H (1.66m x 1.00m x 28cm) inflated
- 12ga (0.30mm) vinyl
- Soft inflatable floor
- Good for use on balconies and terraces
- Capacity 6½" (17cm) of wall height: 24 gal (90L)
- Repair patch
- Shelf box
6 ea, 23.9 lb (10.9 kg)

AGE 2+



57173NP/EP

MINI FRAME™ POOL

- 48" L x 48" W x 12" H (1.22m x 1.22m x 30cm) set-up size
- 20ga (0.50mm) wall, 10ga (0.25mm) floor
- Galvanized metal steel
- Foam padded horizontal beams for comfort
- Capacity 9½" (24cm) of wall height: 90 gal (342L)
- Drain plug
- Repair patch
- Shelf box
3 ea, 27.7 lb (12.6 kg)

AGE 2+



58431NP/EP

SOFT SIDE POOL

- 74" x 18" (1.88m x 46cm) inflated
- 10ga (0.25mm) rings; 8ga (0.20mm) floor
- Capacity 12" (30cm) of wall height: 209 gal (790L)
- 3 air chambers with unique side panel construction
- Drain plug
- Repair patch
- Shelf box
3 ea, 18.8 lb (8.6 kg)

AGE 3+



59416NP/EP

CRYSTAL BLUE POOL

- 45" x 10" (1.14m x 25cm) inflated
- 8ga (0.20mm) rings; 7ga (0.18mm) floor
- Capacity 7" (18cm) of wall height: 41 gal (156L)
- Repair patch
- 12 ea, 22.7 lb (10.3 kg)

AGE 2+

58426NP/EP

CRYSTAL BLUE POOL

- 58" x 13" (1.47m x 33cm) inflated
- 8ga (0.20mm) rings; 7ga (0.18mm) floor
- Capacity 9" (23cm) of wall height: 87 gal (330L)
- Repair patch
- Shelf box
6 ea, 18.9 lb (8.6 kg)

AGE 2+

58446NP/EP

CRYSTAL BLUE POOL

- 66" x 15" (1.68m x 38cm) inflated
- 9ga (0.23mm) rings; 7ga (0.18mm) floor
- Capacity 11½" (29cm) of wall height: 154 gal (581L)
- Repair patch
- Shelf box
6 ea, 28.3 lb (12.9 kg)

AGE 2+

Spray Pools

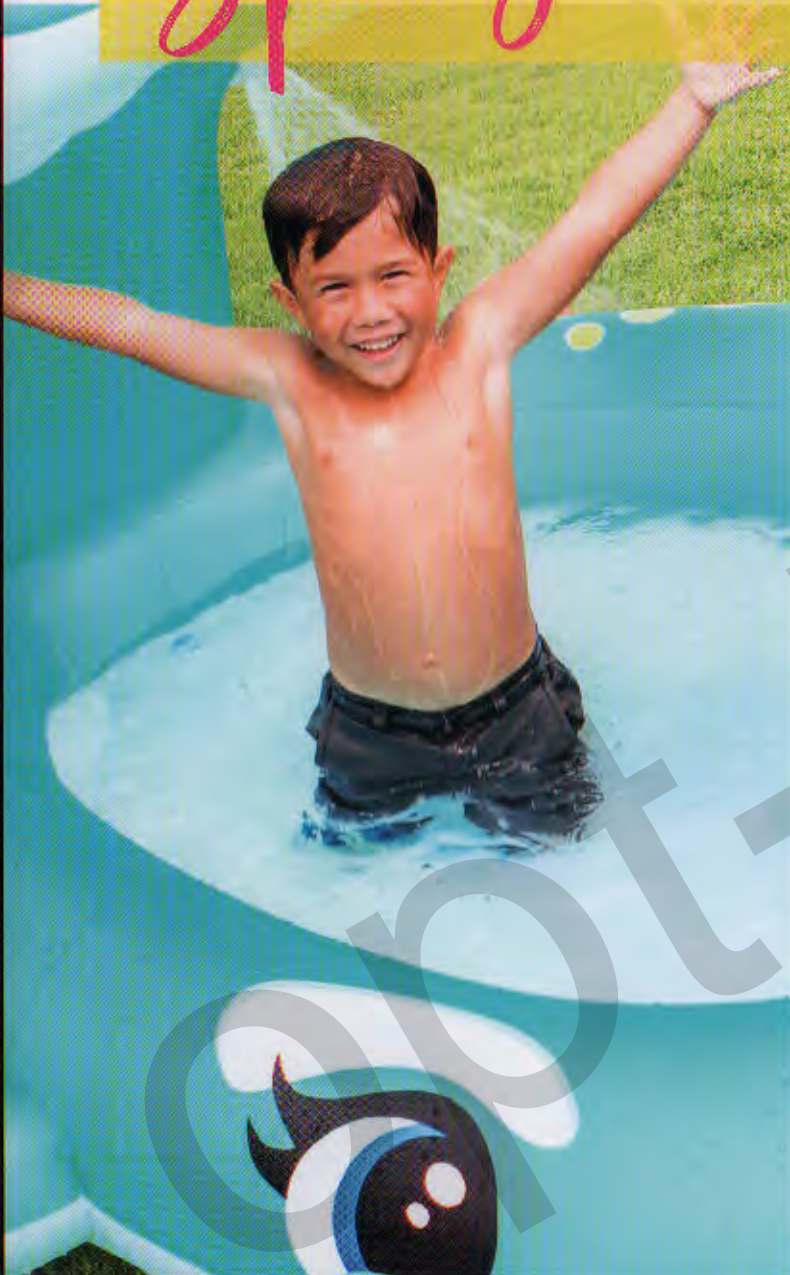

NEW

57440NP/EP WHALE SPRAY POOL

- 79" L x 77" W x 36" H (2.01m x 1.96m x 91cm) inflated
- 11ga (0.28mm) vinyl
- Sprayer spout attaches to garden hose
- Capacity 7' (18cm) of wall height 53 gal (200L)
- Drain plug
- Repair patch
- Shelf box 4 ea, 27.4 lb (12.4 kg)

AGE 2+

NEW Item



57441NP/EP MYSTIC UNICORN SPRAY POOL

- 107" L x 76" W x 41" H (2.72m x 1.93m x 1.04m) inflated
- 11ga (0.28mm) vinyl
- Sprayer spout attaches to a garden hose
- Vibrant colors
- Capacity 6½' (17cm) of wall height 40 gal (151L)
- Drain plug
- Repair patch
- Shelf box 4 ea, 26.7 lb (12.2 kg)

AGE 2+

Snapset™ Pools

56451NP/EP UNDER THE PALM TREES SNAPSET™ POOL

- Approximate set-up size:
5' x 10' (1.52m x 25cm)
- Capacity 9½' (24cm) of wall height:
117 gal (443L)
- Repair patch
- Shelf box
6 ea, 19.4 lb (8.8 kg)

AGE 3+



NEW

58477NP/EP DUCKLING SNAPSET™ POOL

- Approximate set-up size:
4' x 10' (1.22m x 25cm)
- Fun duckling graphics
- Capacity 9½' (24cm) of wall height:
74 gal (218L)
- Repair patch
- Shelf box
6 ea, 14.8 lb (6.7 kg)

AGE 3+

NEW



56452NP/EP OCEAN PLAY SNAPSET™ POOL

- Approximate set-up size:
6' x 1'3" (1.83m x 38cm)
- Fun sea animals
- Capacity 14½' (37cm) of wall
height: 253 gal (958L)
- Repair patch
- Shelf box
6 ea, 30.5 lb (13.9 kg)

AGE 3+



58472NP/EP DEEP BLUE SEA SNAPSET™ POOL

- Approximate set-up size:
8' x 1'6" (2.44m x 46cm)
- Ocean graphics
- Capacity 17½' (44cm) of wall height:
539 gal (2,040L)
- Repair patch
- Shelf box
4 ea, 37.8 lb (17.2 kg)

AGE 3+

57482NP/EP

MY SEA FRIENDS POOL

- 64" L x 42" W x 18" H (1.63m x 1.07m X 46cm) inflated
- Durable 12ga (0.30mm) vinyl
- Capacity 11" (28cm) of wall height: 61 gal (230L)
- Sea animal graphics for added fun
- 3 blue transparent rings
- Drain plug
- Repair patch
- Shelf box
- 6 ea, 35.4 lb (16.1 kg)

AGE 3+



58480NP/EP

AQUARIUM POOL

- 60" x 22" (1.52m x 56cm) inflated
- Durable 12ga (0.30mm) vinyl
- Inflatable floor
- Ideal as an adult lounging spa
- Capacity 16" (41cm) of wall height: 95 gal (360L)
- Drain plug
- Repair patch
- Shelf box
- 3 ea, 23.4 lb (10.6 kg)

AGE 6+



57471NP/EP

SEA AQUARIUM POOL

- 62½" L x 62½" W x 19½" H (1.59m x 1.59m x 50cm) inflated
- 12ga (0.30mm) vinyl
- Capacity 11" (28cm) of wall height: 90 gal (340L)
- Drain plug
- Repair patch
- Shelf box
- 3 ea, 24.0 lb (10.9 kg)

AGE 3+



Printing on Frosted PVC

Swim Center™



5747ONP/EP
SUN SHADE POOL

- 62" L x 62" W x 48" H (1.57m x 1.57m x 1.22m) inflated
- 10ga (0.25mm) vinyl
- Capacity 81/2' (22cm) of wall height: 78 gal (295L)
- Removable sunshade
- Drain plug
- Repair patch
- Patent No. 6,209,150
- Shelf box
- 3 ea. 25.1 lb (11.4 kg)

AGE 2+



56493NP/EP
OCEAN REEF POOL

- 75" L x 70" W x 24" H (1.91m x 1.78m x 61cm) inflated
- 12ga (0.30mm) vinyl
- Inflatable floor
- Capacity 16" (41cm) of wall height: 135 gal (510L)
- Drain plug
- Repair patch
- Shelf box
- 3 ea. 31.6 lb (14.4 kg)

AGE 6+

56495NP/EP

SUMMER COLORS POOL

- 73" L x 71" W x 21" H
(1.85m x 1.80m x 53cm) inflated
- 12ga (0.30mm) vinyl
- Five sided shape with see-through sidewalls
- Inflatable floor
- Capacity 14" (36cm) of wall height: 122 gal (460L)
- Drain plug
- Repair patch
- Shelf box
- 3 ea, 28.6 lb (13.0 kg)

AGE 3+

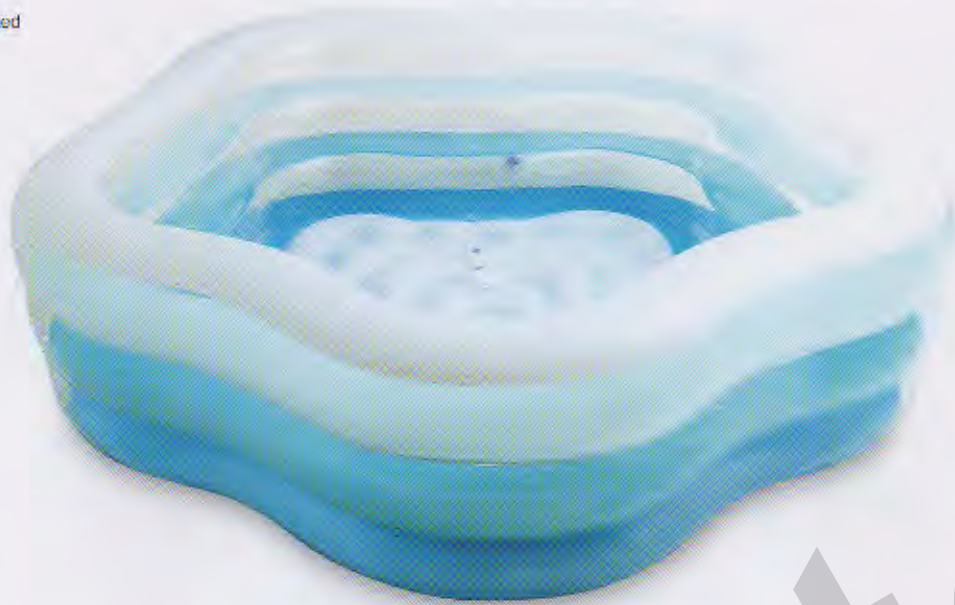

57495NP/EP

BEACH WAVE SWIM CENTER™ POOL

- 90" L x 90" W x 22" H
(2.29m x 2.29m x 56cm) inflated
- 13ga (0.33mm) vinyl
- Wave shape
- 3 Rings
- Capacity 13" (33cm) of wall height: 330 gal (1,250L)
- Drain plug
- Repair patch
- Shelf box
- 2 ea, 29.4 lb (13.4 kg)

AGE 6+



57182NP/EP

SWIM CENTER™ PINWHEEL POOL

- 90" x 22" (2.29m x 56cm) inflated
- 14ga (0.35mm) vinyl with 12ga (0.30mm) wall
- Capacity 11 1/2" (29cm) of wall height: 182 gal (690L)
- Crystal PVC inner beam construction
- Drain plug
- Repair patch
- Shelf box
- 2 ea, 26.0 lb (11.8 kg)

AGE 6+

58484NP/EP

SWIM CENTER™ FAMILY POOL

- 120" L x 72" W x 22" H (3.05m x 1.83m x 56cm) inflated
- 13ga (0.33mm) vinyl
- 3 air chambers each with combo valve for quick inflation and deflation
- Capacity 13" (33cm) of wall height: 269gal (1,020L)
- Drain plug
- Repair patch
- Shelf box
- 2 ea, 32.2 lb (14.6 kg)

AGE 6+



58485NP/EP

SEALIFE SWIM CENTER™ POOL

- 120" L x 72" W x 22" H (3.05m x 1.83m x 56cm) inflated
- 13ga (0.33mm) vinyl
- 3 air chambers each with combo valve for quick inflation and deflation
- I-Beam walls with printed graphics provide strength yet remain comfortable
- Easy to store for next season
- Capacity 13" (33cm) of wall height: 269 gal (1,020L)
- Drain plug
- Repair patch
- Shelf box
- 2 ea, 32.8 lb (14.9 kg)

AGE 6+



57181NP/EP

MANDARIN SWIM CENTER™ FAMILY POOL

- 90" L x 58" W x 18" H (2.29m x 1.47m x 46cm) inflated
- 13ga (0.33mm) vinyl
- 2 rings
- Capacity 13" (33cm) of wall height: 159 gal (600L)
- Drain plug
- Repair patch
- Shelf box
- 3 ea, 28.1 lb (12.8 kg)

AGE 3+

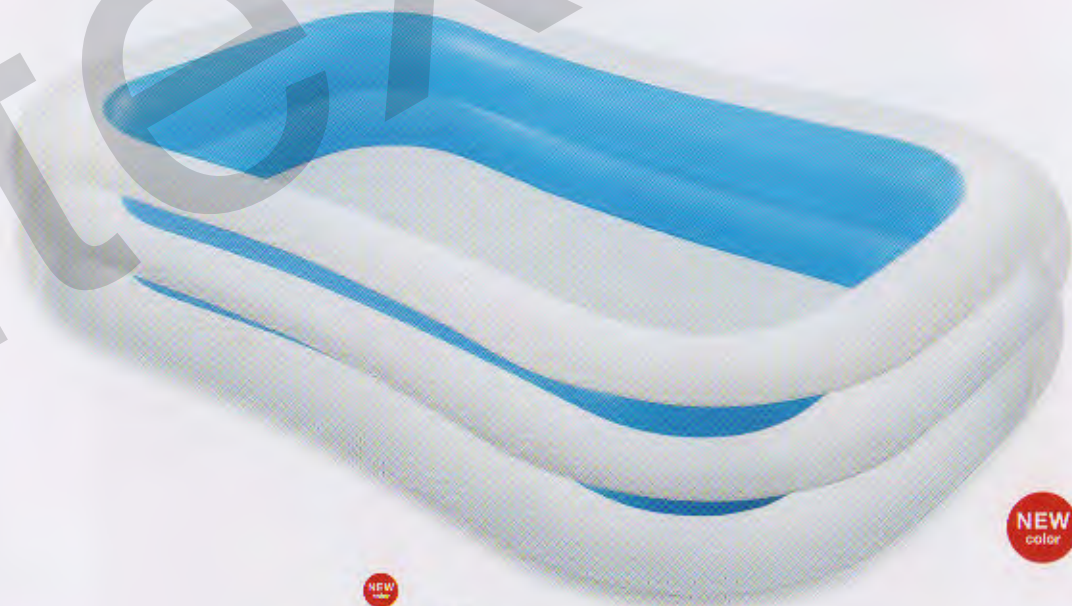

NEW color

NEW

56483NP/EP

SWIM CENTER™ FAMILY POOL

- 103" L x 69" W x 22" H (2.62m x 1.75m x 56cm) inflated
- 12ga (0.30mm) vinyl
- 2 air chambers each with combo valve for quick inflation and deflation
- Capacity 14" (36cm) of wall height: 203 gal (770L)
- Drain plug
- Repair patch
- Shelf box
- 2 ea, 23.3 lb (10.6 kg)

AGE 6+



56475NP/EP
SWIM CENTER™ FAMILY LOUNGE POOL

- 90" L x 90" W x 26" H (2.29m x 2.29m x 66cm) inflated
- 13ga (0.33mm) vinyl
- 4 built-in seats with backrests for lounging or supervising children
- 2 drink holders
- Capacity 14" (35cm) of wall height: 262 gal (990L)
- Drain plug
- Repair patch
- Shelf box
- 2 ea., 29.9 lb (13.6 kg)

AGE 3+

57198NP/EP
SWIM CENTER™ FAMILY CABANA POOL

- 122" L x 74" W x 51" H (3.10m x 1.88m x 1.30m) inflated
- 13ga (0.33mm) vinyl
- Capacity 10" (25cm) of wall height: 185 gal (700L)
- Built-in bench and removable shade transforms this kids pool into a shaded oasis for parents to supervise in
- Sprayer
- Drain plug
- Repair patch
- Shelf box
- 2 ea., 40.0 lb (18.2 kg)

AGE 3+





56490NP/EP
SWIM CENTER™ SEASHORE POOL

- 103" L x 63" W x 18" H (2.62m x 1.60m x 46cm) inflated
- 13ga (0.33mm) vinyl
- 2 air chambers each with combo valve for quick inflation and deflation
- Capacity 12" (30cm) of wall height: 169 gal (640L)
- Drain plug
- Repair patch
- Shelf box
- 3 ea, 30.0 lb (13.7 kg)

AGE 3+



REPAIR PATCHES

Six Patches

59631NP/EP
REPAIR PATCHES

- 6 pcs of 7½ sq. in. (49cm²) stick-on patches
- Blister card
- 36 ea, 1.6 lb (0.7 kg)

AGE 14+



VINYL REPAIR KIT

One Repair Kit

59632NP/EP
REPAIR KIT

- 21 sq. in. (132cm²) vinyl sheet
- ½ oz. (5.7g) tube of vinyl cement
- Blister card
- 36 ea, 2.2 lb (1.0 kg)
- Not available in Europe



57190NP/EP
SWIM CENTER™ FAMILY LOUNGE POOL

- 88" L x 85" W x 30" H (2.24m x 2.16m x 76cm) inflated
- 13ga (0.33mm) vinyl
- Parents get comfy on the built-in bench while the little ones enjoy the water
- 2 air chambers each with combo valve for quick inflation and deflation
- Capacity 12" (30cm) of wall height: 156 gal (590L)
- Drain plug
- Repair patch
- Shelf box
- 2 ea, 33.5 lb (15.2 kg)

AGE 3+

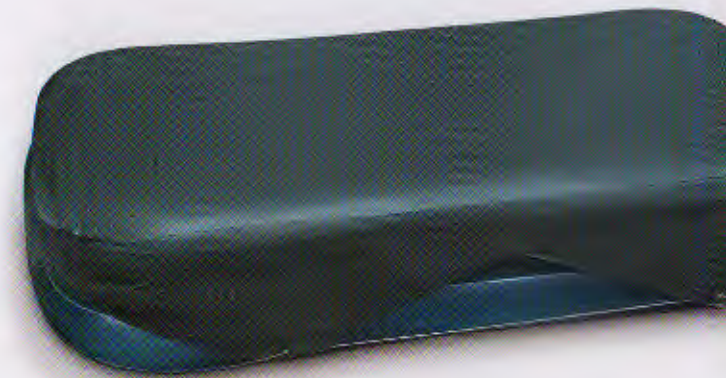

58412NP/EP
RECTANGULAR POOL COVER

- Fits Swim Center™ Family Pools: 120" x 72" (3.05m x 1.83m) or 103" x 69" (2.62m x 1.75m)
- 20" (51cm) overhang
- Shelf box
- 6 ea, 27.3 lb (12.4 kg)

Aquaflow™





Play Series

Colorful and design oriented for kids.

AGE 3-8 AGE 8+



Sport Series

Superior in design, comfort and durability.

Colors made for teenagers and adults.

AGE 8+ AGE 14+

FEATURES



Lenses incorporate advanced UV protection to reduce the sun's damaging UVA & UVB rays.



Lenses are treated with a special coating that keeps them clear underwater, ensuring 100% visibility.



Products incorporate hypoallergenic materials that protect users from potentially irritating latex.



Snorkel is configured to prevent water from flowing into the top, allowing the diver to easily swim below the surface.



Seals use silicone, ensuring a softer, more form fitting product that is comfortable and water-tight.



Mask contains enhanced glass which is stronger and more transparent than standard models.

Play Series

55601/E
JUNIOR GOGGLES

12 ea, asst.
1.6 lb (0.7 kg)

AGE 3-8



55602/E
PLAY GOGGLES

12 ea, asst.
1.7 lb (0.8 kg)

AGE 3-8



55603/E

FUN GOGGLES

12 ea, asst.
2.6 lb (1.2 kg)

AGE 3-8



55642/E

ADVENTURER SWIM SET

- #55916 Sea Scan Mask with #55922 Hi-Flow Snorkel
- Polycarbonate lens for safety

6 sets, 6.2 lb (2.8 kg)

AGE 8+

LATEX FREE

NEW item



55655/E

MASTER CLASS SWIM SET

- #55916 Sea Scan Swim Mask with #55922 Hi-Flow Snorkel and #55937 Medium Swim Fins
- Fins: Fits shoe sizes 5-8

6 sets, 12.2 lb (5.6 kg)

AGE 8+

LATEX FREE

NEW item



55944/E

SHARK FUN SET

- #55915 Fun Mask with #55922 Hi-Flow Snorkel
- Polycarbonate lens for safety

6 sets, 6.1 lb (2.8 kg)

AGE 3-8

LATEX FREE



55922/E

HI-FLOW SNORKELS

- Polyvinyl chloride mouthpiece for soft comfortable fit
- Medium diameter breathing tube with head contour design ideal for kids

12 ea, asst.
3.4 lb (1.6 kg)

AGE 3-10

LATEX FREE



55915/E
FUN MASKS

- Playful character masks are fun for kids
12 ea, asst, 7.5 lb (3.4 kg)

AGE 3-8

LATEX
FREE



55916/E
SEA SCAN SWIM MASKS

- Hypoallergenic polyvinyl chloride skirt for a comfortable fit
 - Polycarbonate lens
 - Adjustable strap
- 12 ea, asst, 6.8 lb (3.1 kg)

AGE 8+

LATEX
FREE



55936/E
SMALL SWIM FINS

- Fits shoe size US (3-5), EU (35-37), CM (22-24)
 - Designed for more comfort and easy adjustability
- 6 pairs, asst, 7.0 lb (3.2 kg)

LATEX
FREE



55937/E
MEDIUM SWIM FINS

- Fits shoe size US (5-8), EU (38-40), CM (24-26)
 - Designed for more comfort and easy adjustability
- 6 pairs, asst, 9.5 lb (4.3 kg)

LATEX
FREE



Sport
series



55682/E
FREE STYLE SPORT GOGGLES

12 ea, asst, 2.6 lb (1.2 kg)

AGE 8+



55684/E
SPORT RELAY GOGGLES

12 ea, asst, 2.7 lb (1.2 kg)

AGE 8+



55928/E
EASY-FLOW SNORKELS

- Thermoplastic rubber mouthpiece for extra soft comfortable fit
- Head contour design with large diameter breathing tube
- Splash-proof guard to keep surface water out

12 ea, asst, 7.1 lb (3.2 kg)

AGE 8+

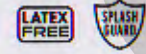

55685/E
WATER SPORT GOGGLES

12 ea, asst, 3.1 lb (1.4 kg)

AGE 14+



55978/E
WAVE RIDER MASKS

- Hypoallergenic thermoplastic rubber skirt for a soft comfortable fit
- Polycarbonate lenses for safety

12 ea, asst, 6.4 lb (2.9 kg)

AGE 8+



55977/E
REEF RIDER MASKS

- Hypoallergenic thermoplastic rubber skirt for a soft comfortable fit
- Polycarbonate lenses for safety

12 ea, asst, 6.8 lb (3.1 kg)

AGE 14+



55647/E
WAVE RIDER SWIM SET

- #55978 Wave Rider Mask with #55928 Easy-Flow Snorkel
- Hypoallergenic, thermoplastic rubber facial skirt

6 sets, 6.8 lb (3.1 kg)

AGE 8+



55648/E
REEF RIDER SWIM SET

- #55977 Reef Rider Mask with #55928 Easy-Flow Snorkel
- Hypoallergenic, thermoplastic rubber facial skirt

6 sets, 7.0 lb (3.2 kg)

AGE 14+





55657/E

REEF RIDER SPORTS SET

- #55977 Reef Rider Mask with
- #55928 Easy-Flow Snorkel
- #55635 Large Super Sport Fins
- Fins: Fits shoe sizes 8-11
- 6 sets, 20.7 lb (9.4 kg)

AGE 14+

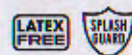

55658/E

WAVE RIDER SPORTS SET

- #55978 Wave Rider Mask with
- #55928 Easy-Flow Snorkel
- #55634 Medium Super Sport Fins
- Fins: Fits shoe sizes 5-8
- 6 sets, 18.1 lb (8.2 kg)

AGE 8+

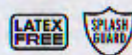

55691/E

SILICONE SPORT RACING GOGGLES

- Soft silicone head strap for high performance
- 12 ea, asst, 2.8 lb (1.3 kg)

AGE 8+



55634/E

MEDIUM SUPER SPORT FINS

- Fits shoe size US (5-8), EU (38-40), CM (24-26)
- High density polymer blades for strong, powerful leg strokes
- open foot design with adjustable strap for optimal fit, channels for less resistance and more speed
- 6 pairs, 14.4 lb (6.5 kg)

LATEX FREE



55635/E

LARGE SUPER SPORT FINS

- Fits shoe size US (8-11), EU (41-45), CM (26-29)
- High density polymer blades for strong, powerful leg strokes
- open foot design with adjustable strap for optimal fit, channels for less resistance and more speed
- 6 pairs, 16.7 lb (7.6 kg)

LATEX FREE



55609/E

EAR PLUGS & NOSE CLIP COMBO SET

- Compact and convenient carrying case for easy storage and transport
- Blister card packaging
- 24 ea, 1.4 lb (0.7 kg)

AGE 8+

LATEX FREE



55692/E

SILICONE SPORT MASTER GOGGLES

Soft silicone head strap for high performance
12 ea. asst. 3.0 lb (1.4 kg)

AGE 14+



55981/E

SILICONE AQUA SPORT MASKS

- Single lens with additional side lens provide a 180° panoramic view
- Soft silicone head strap for high performance

AGE 14+



55924/E

HYPER-FLOW SR. SNORKELS

- Comfortable silicone mouthpiece with integrated silicone purge valve

AGE 8+



55991/E

SILICONE SWIM CAP

Extra soft comfortable fit
Designed to not stick to hair
One size fits all
24 ea. asst. 3.3 lb (1.5 kg)

AGE 8+

LATEX FREE

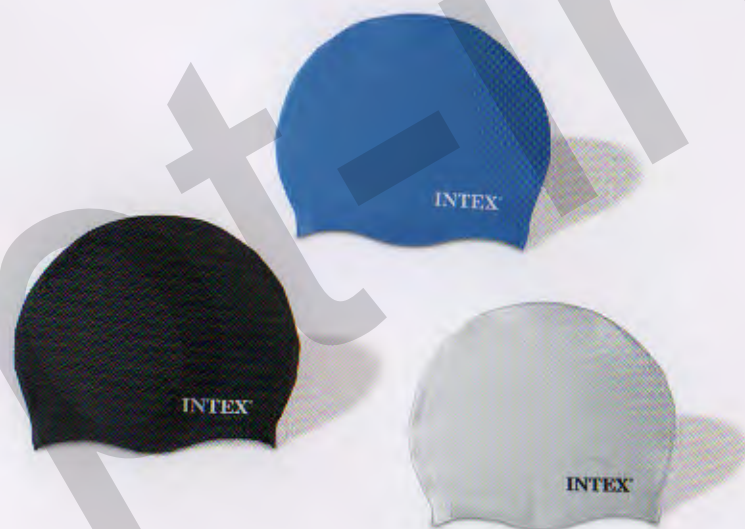

55962/E

SILICONE AQUA SPORT SWIM SET

- #55981 Silicone Aqua Pro Mask with #55924 Hyper-Flow Sr. Snorkel

6 sets, 9.3 lb (4.2 kg)

AGE 14+





Play Series

Bright colors and graphics, perfect for leisurely cruising and relaxing around the pool on lazy summer days.

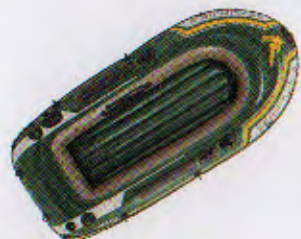

Sport Series

A broad range of recreation boats and kayaks. All models are made with strong and durable materials for stability and rugged use, suited to fishing and boating in lakes and mild rivers.



Pro Series

Designed and engineered for optimum performance, comfort, rigidity and versatility. It features SUPER-TOUGH™ triple-layered, laminated PVC material to maximize comfort and safety, while resisting gasoline, abrasion and sunlight.

Boats



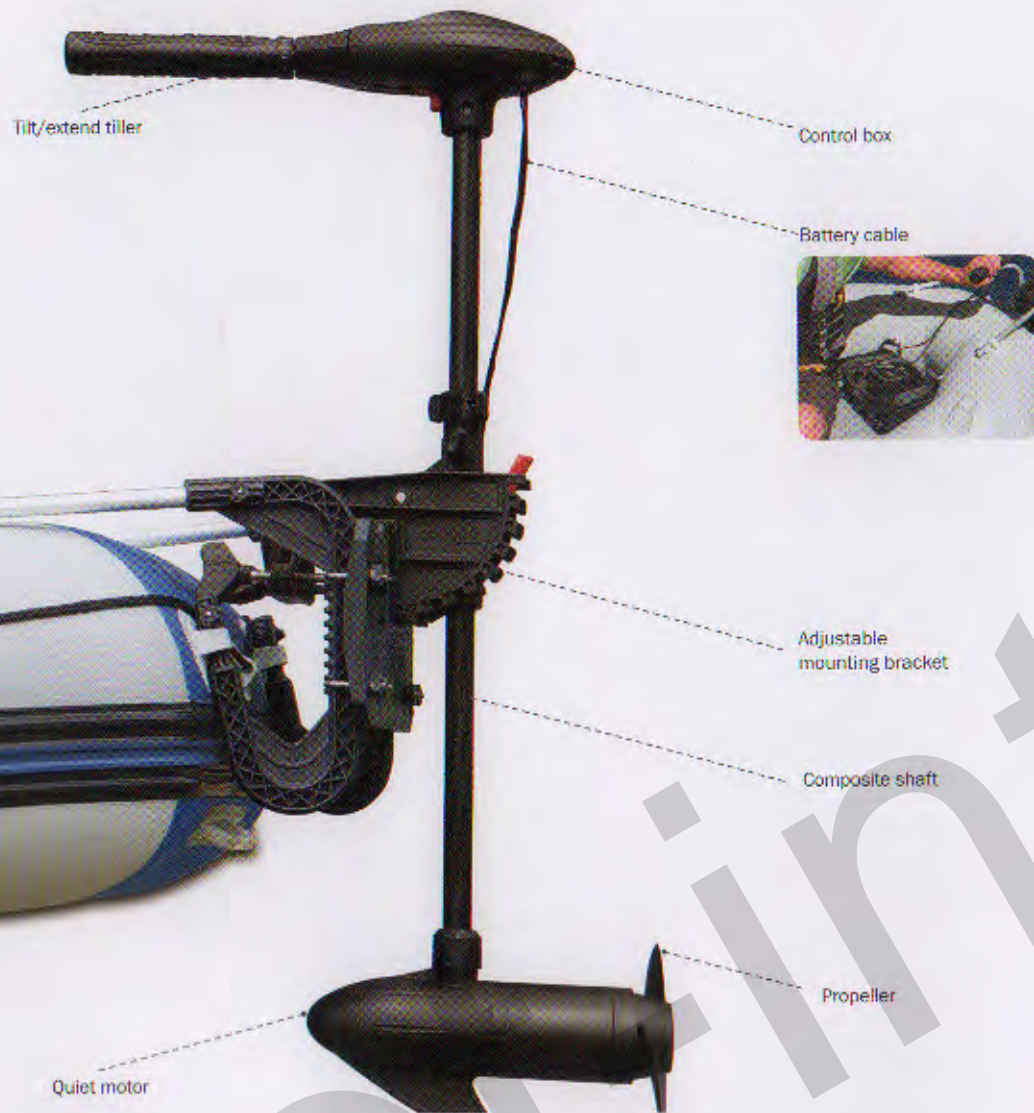

Tilt/extend tiller

Control box

Battery cable



Adjustable mounting bracket

Composite shaft

Propeller

Quiet motor

68631/E TROLLING MOTOR

- For Challenger™ 3, Seahawk™ 2, 3, 4, Excursion™ 4, 5, and Mariner™ 3, 4 boats
- Built-in battery meter
- Tilt/extend tiller
- Quiet motor
- Weed escape mode
- Suitable for freshwater and saltwater
- Easy to attach
- Battery not included
- Shelf box with full-color label
2 ea, 52.3 lb (23.8 kg)

Voltage 12V DC

Power 420W

Thrust 40 lb / 178 (N)

Shaft Length 36in / 91.40cm

Speed 5-forward / 3-reverse

68624NP/EP MOTOR MOUNT KIT

- For Challenger™ 3, Seahawk™ 2, 3, 4, Excursion™ 4, 5, and Mariner™ 3, 4 boats
- Heavy duty composite mount with aluminum supports
- Fits up to 3.0 hp motors
- Easy to attach
- Shelf box
3 ea, 16.5 lb (7.5 kg)



59623/E FRENCH OARS

- 48" (1.22m)
- Easy 3 piece assembly
- Ribbed blade
- Retainer ring for oar locks
- TUV RL approved
- Polybag with header
6 pairs, 14.5 lb (6.6 kg)



69627/E KAYAK PADDLE/BOAT OARS

- Dual purpose -- two separate 48" (1.22m) boat oars or join together for a 96" (2.44m) kayak paddle
- Lightweight, durable aluminum shaft
- Retainer ring for oar locks
- Ribbed blade
- Polybag with header
- TUV RL approved
6 pairs, 20.0 lb (9.1 kg)



Accessories



Play Series

EXPLORER™



Grab rope on bow

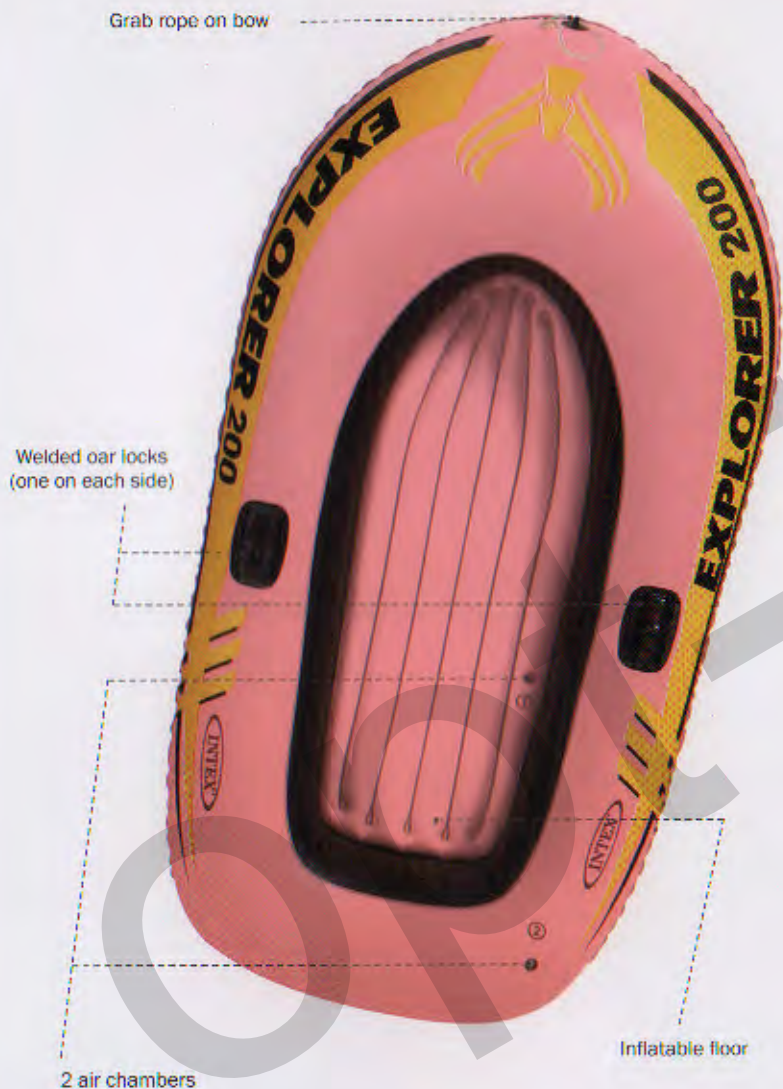

PLAY SERIES EXPLORER™ BOATS 100/200/300

- 2 air chambers with double valves
- Grab rope on bow
- Inflatable floor for comfort and rigidity
- Welded oar locks
- U.S. Coast Guard I.D.
- Repair patch
- Shelf box

AGE 6+



Item #	Model	Case Pack	Case Weight lb (kg)	Inflated Size ft (cm)	Material ga (mm)	Persons Capacity	Capacity lb (kg)	Accessories
58329NP/EP	Explorer™ 100	3 ea	9.5 (4.3)	4'10" x 2'9" x 1'2" (147 x 84 x 36)	11 (0.28)		120 (55)	-
58330NP/EP	Explorer™ 200	3 ea	14.9 (6.8)	6'1" x 3'1" x 1'4" (185 x 94 x 41)	13 (0.33)		210 (95)	-
58331NP/EP	Explorer™ 200 Set	3 ea	22.6 (10.3)	6'1" x 3'1" x 1'4" (185 x 94 x 41)	13 (0.33)		210 (95)	59623 48" French Oars 69613 Mini Air Pump
58332NP/EP	Explorer™ 300 Set	3 ea	32.2 (14.6)	6'11" x 3'10" x 1'4" (211 x 117 x 41)	15 (0.38)		410 (186)	59623 48" French Oars 68612 High-Output Pump

EXPLORER™ PRO

PLAY SERIES EXPLORER™ PRO BOATS 50/100/200/300

- 3 air chambers including inner auxiliary chamber inside main hull
- Quick-fill, fast deflate Boston valve on main hull chamber (excluding 50)
- All-around grab line
- Inflatable I-beam floor for comfort and rigidity
- Grab handle on bow
- Welded on oar locks (excluding 50)
- Oar holders (models 200/300)
- U.S. Coast Guard I.D.
- TUV approved (excluding 50)
- Repair patch
- Shelf box

AGE 6+

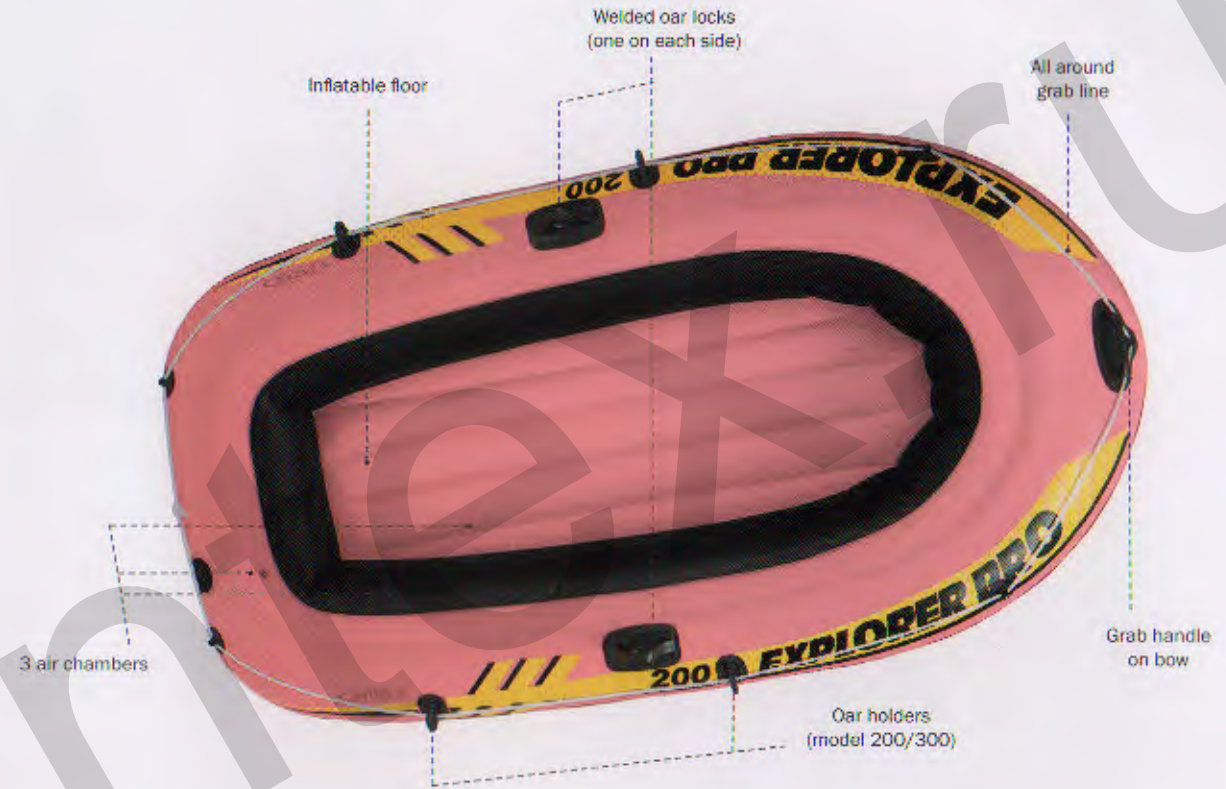

Item #	Model	Case Pack	Case Weight lb (kg)	Inflated Size in (cm)	Material ga (mm)	Persons Capacity	Capacity lb (kg)	Standard	Accessories
58354NP/EP	Explorer™ Pro 50	4 ea	17.3 (7.9)	4'6" x 2'9½" x 9" (137 x 85 x 23)	12 (0.30)		88 (40)	EN25649	-
58355NP/EP	Explorer™ Pro 100	3 ea	17.1 (7.8)	5'3" x 3'1" x 11½" (160 x 94 x 29)	12 (0.30)		176 (80)		-
58356NP/EP	Explorer™ Pro 200	3 ea	25.6 (11.6)	6'5" x 3'4" x 11" (196 x 102 x 33)	14 (0.35)		264 (120)		-
58357NP/EP	Explorer™ Pro 200 Set	3 ea	34.6 (15.7)	6'5" x 3'4" x 11" (196 x 102 x 33)	14 (0.35)		264 (120)		59623 48" French Oars 68612 High-Output Pump
58358NP/EP	Explorer™ Pro 300 Set	2 ea	34.1 (15.5)	8' x 3'10" x 1'2" (244 x 117 x 36)	16 (0.40)		440 (200)		59623 48" French Oars 68612 High-Output Pump

Sport Series



68367



68370



68367 Challenger™ 2 Set Accessories



68370 Challenger™ 3 Set Accessories



CHALLENGER™



SPORT SERIES CHALLENGER™

- 3 air chambers including an inner auxiliary chamber inside main hull
- Quick-fill, fast-deflate Boston valve on main hull chamber (model 1)
- Two quick-fill, fast-deflate Boston valves (models 2 & 3)
- The INNER AUXILIARY CHAMBER alone will keep you afloat
- Rugged vinyl construction
- All-around grab line
- Inflatable I-beam floor for comfort and rigidity
- Inflatable cushions (model 3)
- Grab handles on bow
- Welded on oar locks
- Oar holders (model 2 & 3)
- Motor mount fittings (model 3)
- U.S. Coast Guard I.D.
- TUV approved
- Repair patch
- Shelf box



Item #	Model	Case Pack	Case Weight lb (kg)	Inflated Size in (cm)	Material ga (mm)	Persons Capacity	Capacity lb (kg)	Motor hp (kW)	Standard	Accessories
68367NP/EP	Challenger™ 2 Set	2 ea	34.2 (15.5)	7'9" x 3'9" x 1'4" (236 x 114 x 41)	18 (0.45)		440 (200)		ISO 6185-1 / NMMA-ABYC	59623 48" French Oars 68612 High-Output Pump
68370NP/EP	Challenger™ 3 Set	2 ea	57.8 (26.3)	9'8" x 4'6" x 1'5" (295 x 137 x 43)	20 (0.50)		704 (320)	1.5 (1.1)	ISO 6185-1 / NMMA-ABYC	48" Aluminum Oars 68614 High-Output Pump

SEAHAWK™



Item #	Model	Case Pack	Case Weight lb (kg)	Inflated Size in (cm)	Material ga (mm)	Persons Capacity	Capacity lb (kg)	Motor hp (KW)	Standard	Accessories
68347NP/EP	Seahawk™ 2 Set	2 ea	40.0 (18.2)	7'9" x 3'9" x 1'4" (236 x 114 x 41)	20 (0.50)		520 (240)	1.5 (1.1)	ISO 6185-1 NMMA-ABYC	59623 48" French Oars 68612 High-Output Pump
68380NP/EP	Seahawk™ 3 Set	1 ea	33.4 (15.2)	9'8" x 4'6" x 1'5" (295 x 137 x 43)	23 (0.58)		790 (360)	1.5 (1.1)	ISO 6185-1 NMMA-ABYC	48" Aluminum Oars 68614 High-Output Pump
68351NP/EP	Seahawk™ 4 Set	1 ea	48.0 (21.8)	11'6" x 4'9" x 1'7" (351 x 145 x 48)	30 (0.75)		1,050 (480)	1.5 (1.1)	ISO 6185-1 NMMA-ABYC	48" Aluminum Oars 68614 High-Output Pump

68347 Seahawk™ 2 Set and accessories



68380 Seahawk™ 3 Set and accessories



68351 Seahawk™ 4 Set and accessories



SPORT SERIES SEAHAWK™

- 3 air chambers including an inner auxiliary chamber inside main hull
- Two quick-fill, fast-deflate Boston valves
- The INNER AUXILIARY CHAMBER alone will keep you afloat
- Rugged vinyl construction
- All-around grab line
- Inflatable I-beam floor for comfort and rigidity
- Inflatable cushions (models 3 & 4)
- 1 gear pouch
- Two fishing rod holders
- Grab handles on bow
- Welded on oar locks
- Oar holders
- Motor mount fittings
- U.S. Coast Guard I.D.
- TUV approved
- Repair patch
- Shelf box





68325 Excursion™ 5 Set



68324 Excursion™ 4 Set



**SPORT SERIES
EXCURSION™**

- 3 air chambers including an auxiliary air chamber in hull for extra buoyancy
- The INNER AUXILIARY CHAMBER alone will keep you afloat
- Boston valve on two main hull chambers for quick-fill, fast deflate
- Rugged vinyl construction
- All-around grab line
- Inflatable I-beam floor for comfort and rigidity
- Two fishing rod holders (models 4)
- Four fishing rod holders (model 5)
- Two roomy inflatable seats with backrests
- 1 gear pouch
- Grab handles
- Welded oar locks
- Oar holders
- Motor mount fittings
- U.S. Coast Guard I.D.
- TUV approved
- Carry bag
- Repair patch
- Shelf box



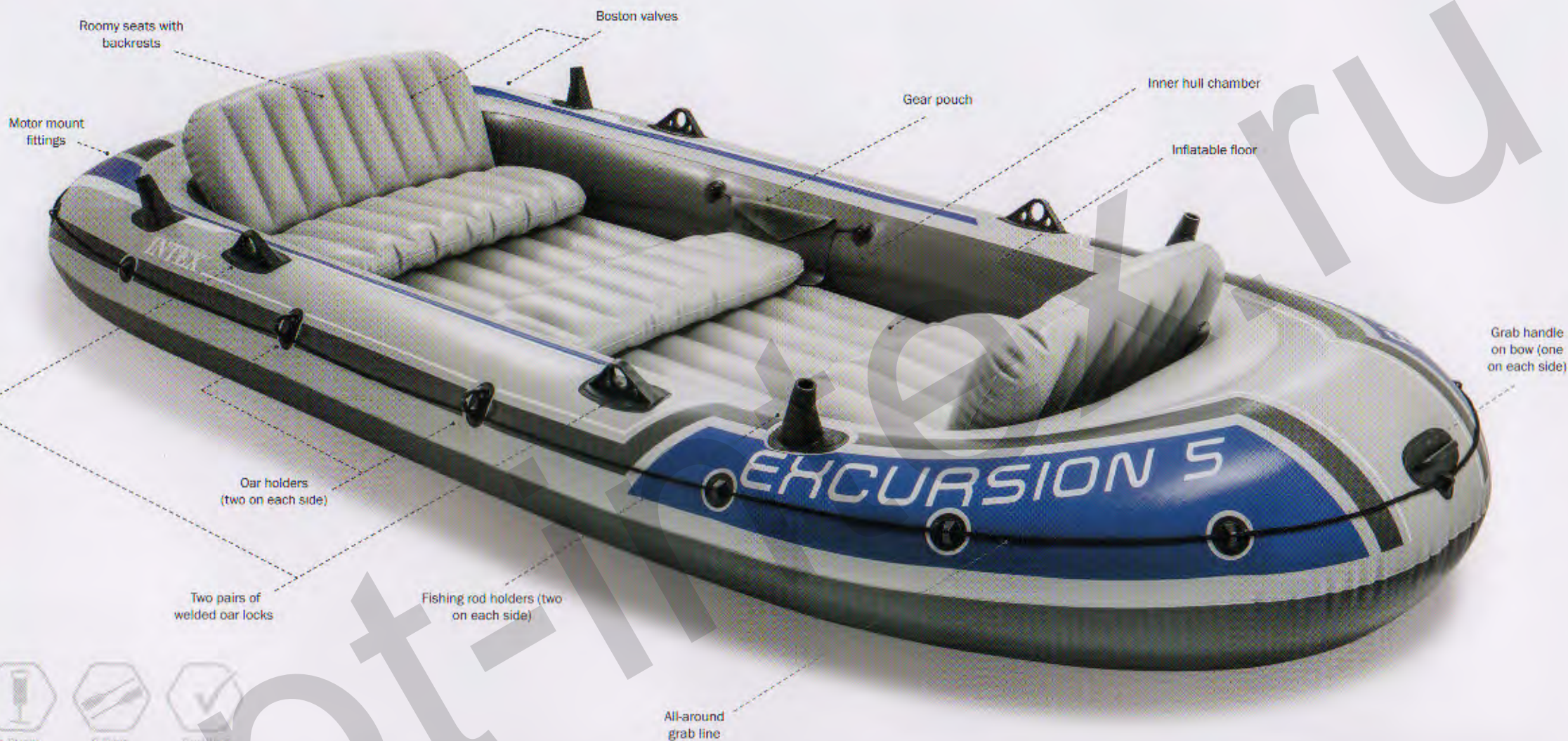

EXCURSION™



Item #	Model	Case Pack	Case Weight lb (kg)	Inflated Size in (cm)	Material ga (mm)	Persons Capacity	Capacity lb (kg)	Motor hp (kW)	Standard	Accessories
68324NP/EP	Excursion™ 4 Set	1 ea	48.6 (22.1)	10'4" x 5'5" x 1'5" (315 x 165 x 43)	30 (0.75)		1,100 (500)	1.5 (1.1)	ISO 6185-1 NMMA-ABYC	54" Aluminum Oars 68614 High-Output Pump
68325NP/EP	Excursion™ 5 Set	1 ea	57.6 (26.2)	12' x 5'6" x 1'5" (366 x 168 x 43)	30 (0.75)		1,320 (600)	1.5 (1.1)	ISO 6185-1 NMMA-ABYC	54" Aluminum Oars 68614 High-Output Pump

CHALLENGER™ K1 & K2

Item #	Model	Case Pack	Case Weight lb (kg)	Inflated Size in (cm)	Material ga (mm)	Persons Capacity	Capacity lb (kg)	Standard	Accessories
68305NP/EP	Challenger™ K1	2 ea	56.9 (25.9)	9' x 2'6" x 1'1" (274 x 76 x 33)	30 (0.75)		220 (100)	ISO 6185-1 / NMMA-ABYC	86" Aluminum Oars 68614 High-Output Pump
68306NP/EP	Challenger™ K2	1 ea	39.6 (18.0)	11'6" x 2'6" x 1'3" (351 x 76 x 38)	30 (0.75)		400 (180)	ISO 6185-1 / NMMA-ABYC	86" Aluminum Oars 68614 High-Output Pump

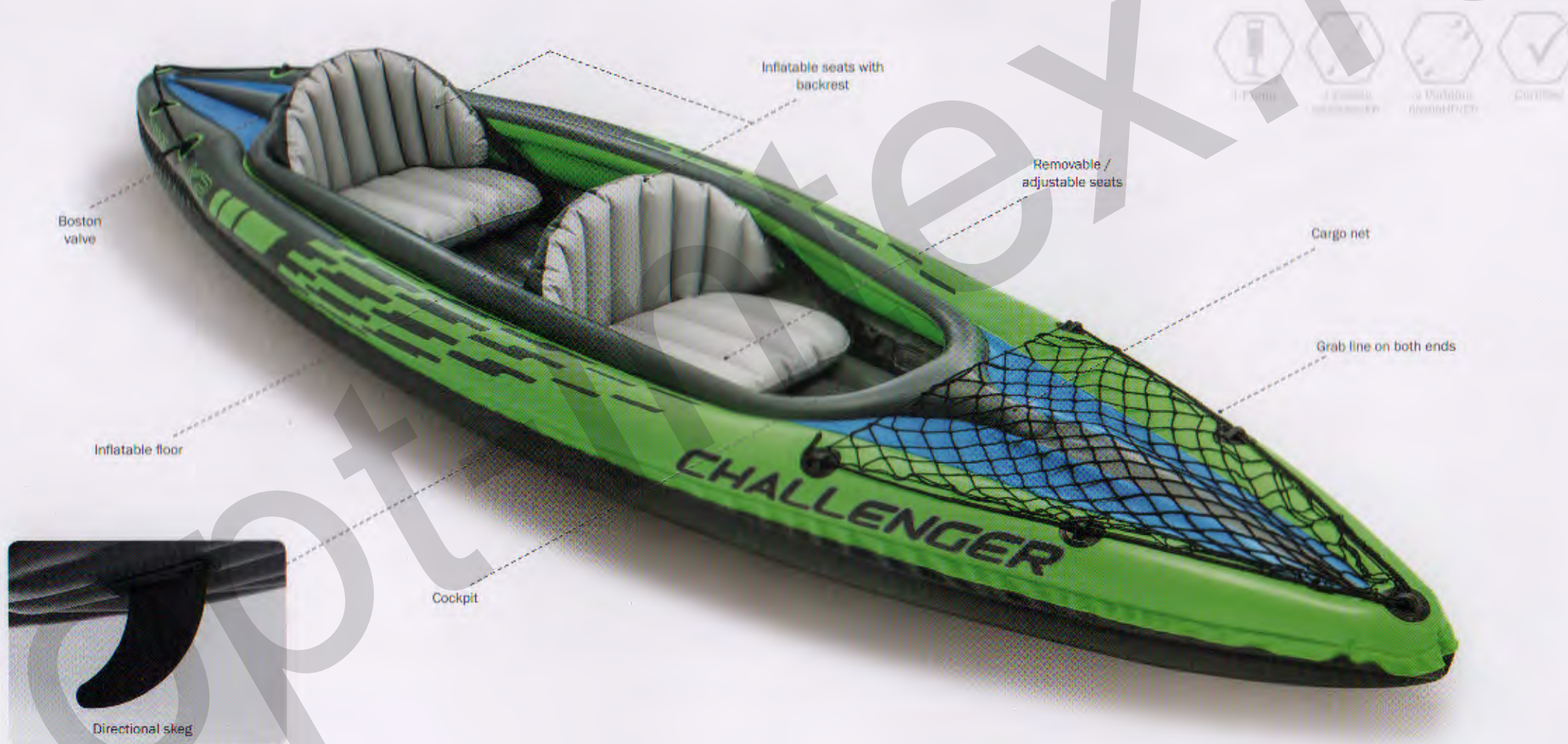



68305 Challenger™ K1 Kayak and Accessories



68306 Challenger™ K2 Kayak and Accessories



SPORT SERIES

CHALLENGER™ K1 & K2

- Sporty graphics for high visibility
- Low-profile for lakes and mild rivers
- Streamlined design for easy paddling
- Cockpit designed for comfort and space
- Rugged vinyl construction
- Grab line on both ends
- Cargo net for extra storage
- Adjustable inflatable seat with backrest
- Inflatable I-beam floor for comfort and rigidity
- Removable skeg for directional stability
- U.S. Coast Guard I.D.
- TUV approved
- Carry bag
- Repair patch
- Shelf box





EXPLORER™ K1 & K2

68307 Explorer™ K2 Kayak and Accessories

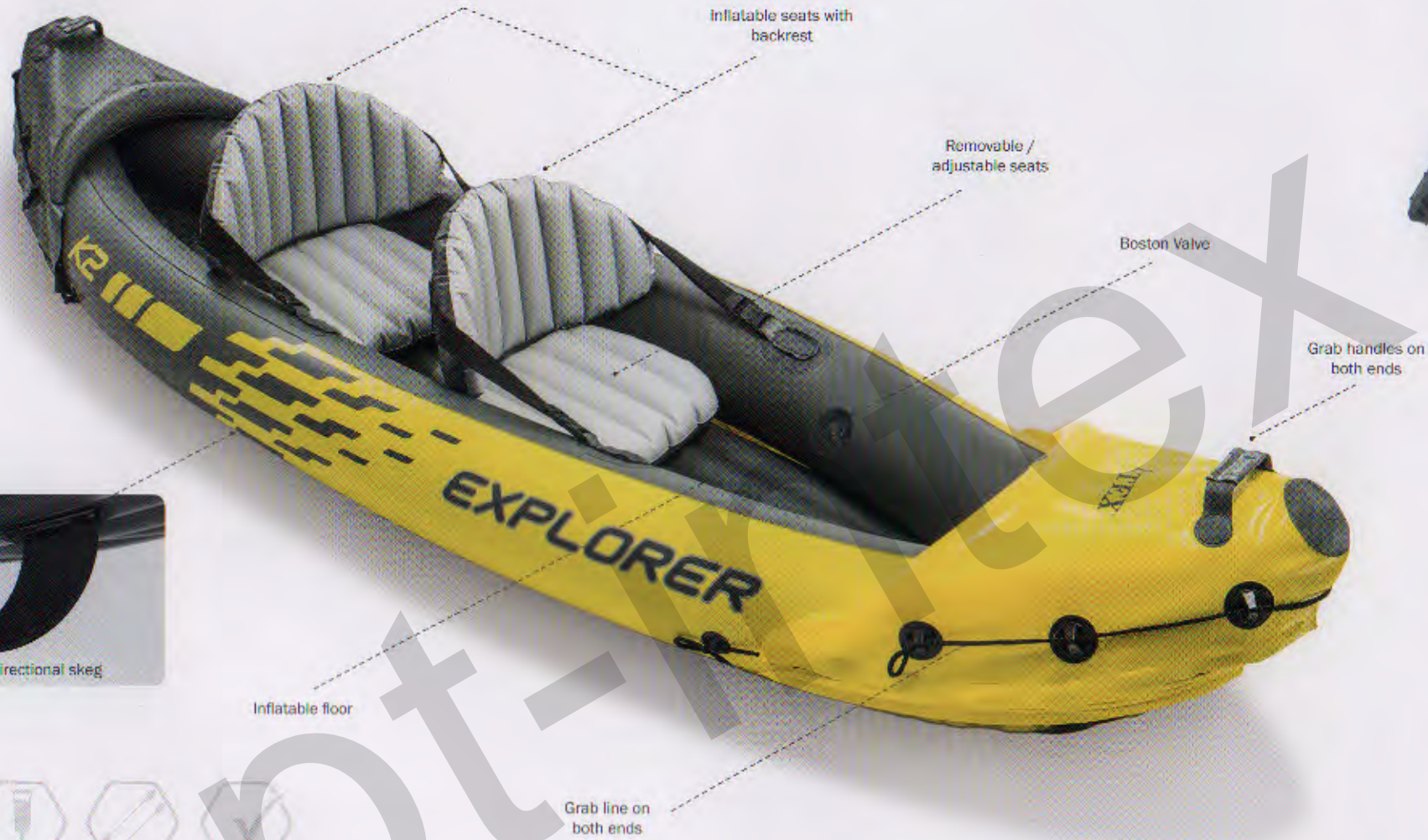

SPORT SERIES EXPLORER™ K2

- Sporty graphics for high visibility
- Low profile for lakes and mild rivers
- Streamlined design for easy paddling
- Cockpit designed for comfort and space
- Rugged vinyl construction
- Grab line on both ends
- Adjustable inflatable seats with backrest
- Inflatable I-beam floor for comfort and rigidity
- Removable skeg for directional stability
- U.S. Coast Guard I.D.
- TUV approved
- Carry bag
- Repair patch
- Shelf box



Item #	Model	Case Pack	Case Weight lb (kg)	Inflated Size in (cm)	Material ga (mm)	Persons Capacity	Capacity lb (kg)	Standard	Accessories
68307NP/EP	Explorer™ K2	1 ea	37.1 (16.9)	10'3" x 3' x 1'8" (312 x 91 x 51)	30 (0.75)		400 (180)	ISO 6185-1 NMMA-ABYC	86" Aluminum Oars 68614 High Output Pump



Pro Series



NEW

PROFESSIONAL SERIES

EXCURSION PRO

- SUPER-TOUGH™ Laminate material with Polyester core for high strength and durability, ensuring high impact and abrasion resistance, while retaining light weight and portability
- High pressure inflation provides extra rigidity and stability, with high pressure spring loaded valves for easy inflation and fast deflation
- Two specially designed removable skogs for optimal maneuverability through deep and shallow waters
- Two floor mounted footrests
- Two integrated recessed fishing rod holders
- Removable and adjustable mounting bracket for additional accessories, such as GPS systems, fish finders, swivel fishing rod holders, etc.
- Grab handle on both ends
- Two adjustable bucket seats
- Inflatable booster pad for elevated seating
- Storage space in bow and stern with stainless steel D-rings for tying down dry bags and gear
- U.S. Coastguard I.D.
- TUV approved
- Patents pending
- Carry bag
- Repair patch
- Shelf box



* 3-ply SUPER-TOUGH™ construction employs a high molecular PVC that is unaffected by gasoline, oil and salt water. It is highly resistant to damage from abrasion, impact and sunlight. It also permits more air pressure for rigidity.



EXCURSION PRO



Adjustable foot rests

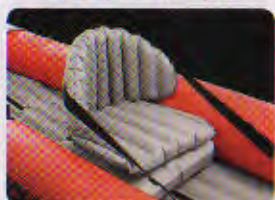

Inflatable booster pad

Inflatable seats with backrest

Fishing rod holders (one on each side)

Removable / adjustable seats

Grab handles on both ends

Grab line on both ends

Inflatable floor



Directional skog



Shallow water Directional skog



Storage Area



Mounting bracket for additional accessories



NEW Item

Item #	Model	Case Pack	Case Weight lb (kg)	Inflated Size in (cm)	Material ga (mm)	Persons Capacity	Capacity lb (kg)	Standard	Accessories
68309NP/EP	Excursion™ Pro	1 ea	47.0 (21.4)	12'7" x 3'1" x 1'6" (384 x 94 x 46)	30 (0.75)		400 (180)	ISO 6185-1 NMMA-ABYC	86" Aluminum Oars 68605 High-Output Pump



MARINER™ 3

68373 Mariner™ 3 Set and Accessories

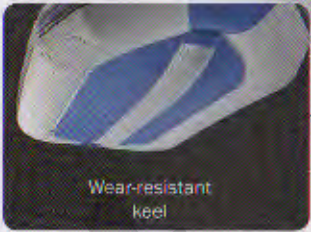
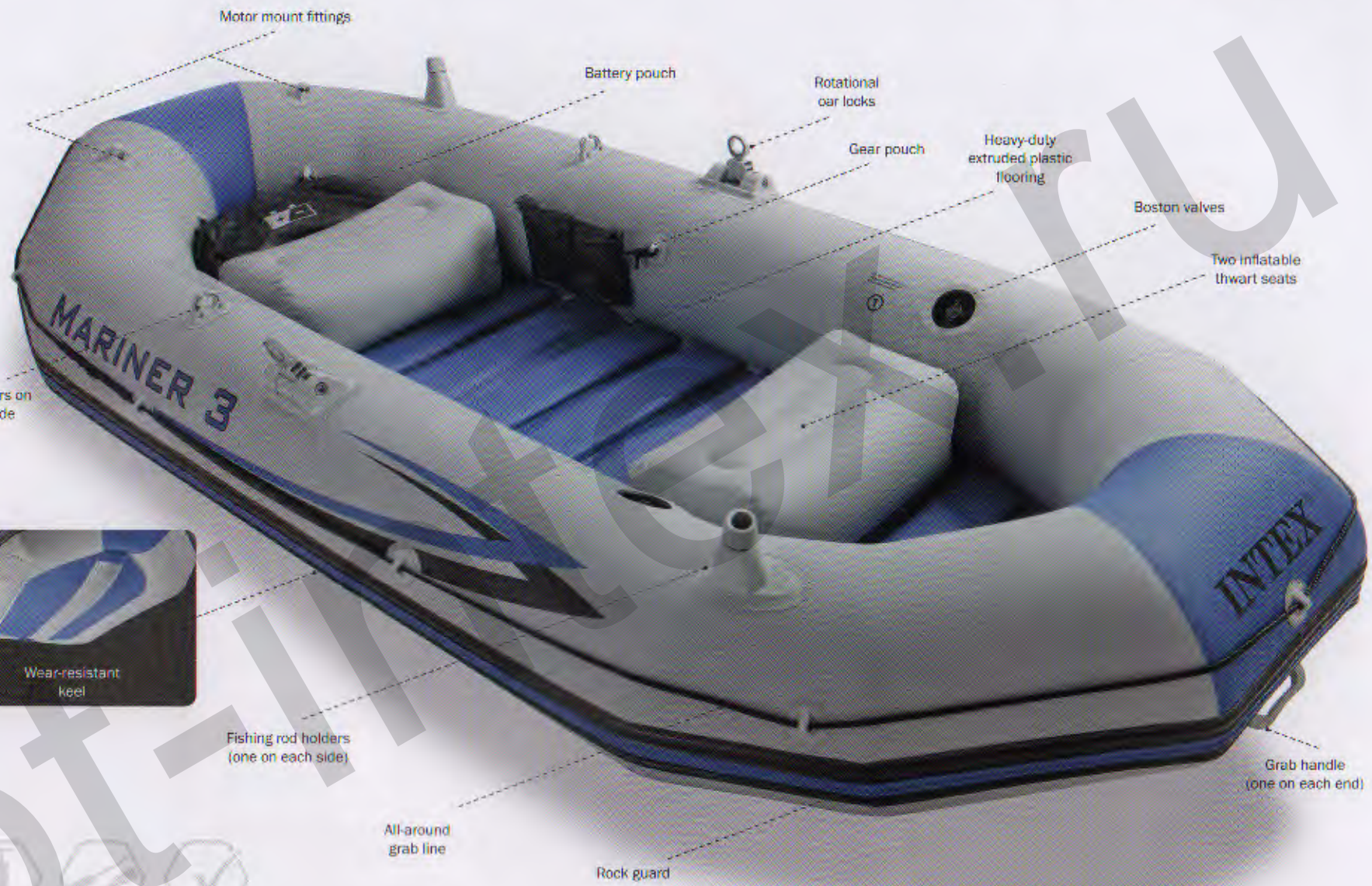

PROFESSIONAL SERIES MARINER™ 3

- Two Boston valves on main hull chamber for quick-fill, fast-deflate
- SUPER-TOUGH™ Construction* is triple strong. Made with 3 separate layers of material for extra strength and durability — two outer layers of heavy-gauge PVC laminated to an inner layer of polyester mesh for extra reinforcement
- All-around grab line and rub strake
- Heavy-duty extruded plastic flooring for comfort and rigidity
- Two fishing rod holders
- Two inflatable thwart seats
- 1 gear pouch and 1 battery pouch
- Grab handle on both ends
- Welded-on rotational oar locks
- Motor mount fittings
- Oar holders
- U.S. Coast Guard I.D.
- TUV approved
- Carry bag
- Repair patch
- Shelf box



* 3-ply SUPER-TOUGH™ Construction employs a high molecular PVC that is unaffected by gasoline, oil and salt water. It is highly resistant to damage from abrasion, impact and sunlight. It also permits more air pressure for rigidity.

Item #	Model	Case Pack	Case Weight lb (kg)	Inflated Size In (cm)	Material ga (mm)	Persons Capacity	Capacity lb (kg)	Motor hp (kW)	Standard	Accessories
68373NP/EP	Mariner™ 3 Set	1 ea	73.9 (33.6)	9'9" x 4'2" x 1'6" (297 x 127 x 46)	30 (0.75)		880 (400)	2 (1.5)	ISO 6185 1 NMMA-ABYC	54" Aluminum Oars 68605 High-Output Pump



68376 Mariner™ 4 Set
Accessories



PROFESSIONAL SERIES

MARINER™ 4

- Four Boston valves on main hull chamber for quick fill, fast deflate
- SUPER-TOUGH™ Construction* is triple strong. Made with 3 separate layers of material for extra strength and durability — two outer layers of heavy-gauge PVC laminated to an inner layer of polyester mesh for extra reinforcement
- Inflatable keel for improved control and handling
- All-around grab line and rub strake
- Heavy duty extruded plastic flooring for comfort and rigidity
- Two fishing rod holders
- Three inflatable thwart seats
- 1 gear pouch and 1 battery pouch
- Grab handle on both ends
- Welded-on rotational oar locks
- Motor mount fittings
- Oar holders
- U.S. Coast Guard I.D.
- TUV approved
- Carry bag
- Repair patch
- Shelf box

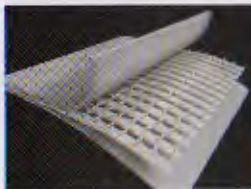

* 3 ply SUPER-TOUGH™ Construction employs a high molecular PVC that is unaffected by gasoline, oil and salt water. It is highly resistant to damage from abrasion, impact and sunlight. It also permits more pressure for rigidity.



MARINER™ 4

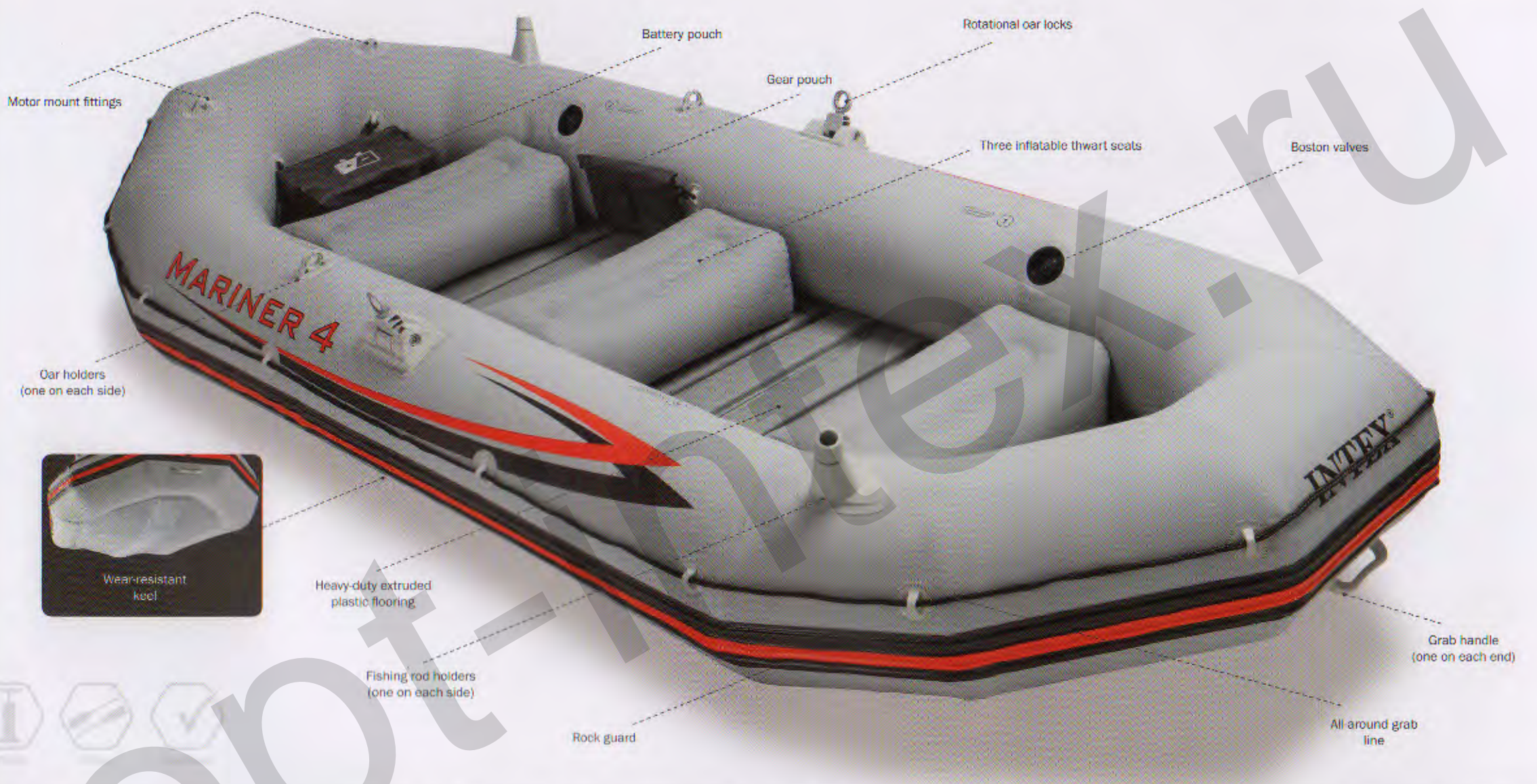

Item #	Model	Case Pack	Case Weight lb (kg)	Inflated Size in (cm)	Material ga (mm)	Persons Capacity	Capacity lb (kg)	Motor hp (kW)	Standard	Accessories
68376NP/EP	Mariner™ 4 Set	1 ea	91.5 (41.6)	10'9" x 4'9" x 1'7" (328 x 145 x 48)	30 (0.75)		1,100 (500)	3 (2.2)	ISO 6185-1 NMMA ABYC	54" Aluminum Oars 68605 High-Output Pump



In Toyz[®]



68556NP/EP
HAPPY ANIMAL CHAIR ASSORTMENT

- Approximate inflated size:
 Bear: 25½" L x 25" W x 29" H
 (65cm x 64cm x 74cm)
 Tiger: 26" L x 25" W x 26" H
 (66cm x 64cm x 66cm)
- Assorted Bear and Tiger
- 12ga (0.30mm) vinyl
- Repair patch
- Shelf box
- 77 lb (35 kg) maximum weight limit
 12 ea, asst, 26.0 lb (11.8 kg)

AGE 3-8

44672NP/EP
3-D BOP BAGS

- Assorted Wrestler and Boxer
- Durable 8ga (0.20mm) vinyl with 12ga (0.30mm) water-weighted base
- Pegable box
 24 ea, asst, 16.3 lb (7.4 kg)

Boxer: 36" x 20" (91cm x 51cm)
 Wrestler: 36" x 28½" (91cm x 72cm)

AGE 3+



44669NP/EP
3-D BOP BAGS

- Assorted Dolphin, Dinosaur and Tiger design
- Durable 8ga (0.20mm) vinyl with 12ga (0.30mm) water-weighted base
- Pegable box
 24 ea, asst, 17.1 lb (7.8 kg)

Dolphin: 38" x 24" (97cm x 61cm)
 Dinosaur: 37" x 24" (94cm x 61cm)
 Tiger: 38½" x 17½" (98cm x 44cm)

AGE 3+





49602NP/EP
SMALL FUN BALLZ™

- 100 air filled 2½" (6.5cm) diameter Fun Ballz™
- 6 assorted colors
- 6 ea, 14.0 lb (6.4 kg)

AGE 2+



49600NP/EP
FUN BALLZ™

- 100 air filled 3¼" (8cm) diameter Fun Ballz™
- 6 assorted colors
- 6 ea, 20.7 lb (9.4 kg)

AGE 2+



NEW Item

NEW

48476NP/EP
SOFT-SIDES™ MY FIRST GYM™

- Approximate inflated size: 50" x 24" (1.27m x 61cm)
- 10ga (0.25mm) vinyl
- Frosted donut design
- 3 squeakers to keep your baby entertained
- Soft inflatable bottom for extra comfort
- Repair patch
- Shelf box
- 3 ea, 15.2 lb (6.9 kg)

AGE 9-18 Months



45642NP/EP
ROYAL CASTLE PLAY TENT

- Approximate set-up size: 37½" L x 29½" W x 42" H (95cm x 75cm x 1.07m)
- Shelf box
- 6 ea, 28.2 lb (12.8 kg)

AGE 3-6





NEW

56514NP/EP

PRINCESS CARRIAGE

- Approximate set-up size:
57" L X 53" W X 41" H
(1.45m x 1.35m x 1.04m)
- Horse inflated size:
49" L x 23" W x 26" H
(1.24m x 58cm x 66cm)
- 12ga (0.30mm) vinyl
- Enchanting pearlescent pink carriage
- Comes with its own friendly horse
- Suitable for both indoors and outdoors
- Repair patch
- Shelf box
- 2 ea, 26.6 lb (12.1 kg)

AGE 3+



NEW
Item

48635NP/EP

PRINCESS PLAY HOUSE

- Approximate inflated size when closed: 49"L x 43"W x 48"H (1.24m x 1.09m x 1.22m)
- Easy to set up inflatable princess house with armchair and table. Open up the house and invite a friend for a tea party!
- 1 comfortable armchair
- 1 table
- cottage: 10ga (0.25mm); armchair & table: 12ga (0.3mm)
- Repair patch
- Shelf Box
- 2 ea, 25.7 lb (11.7 kg)

AGE 2-6



48674NP/EP

CLASSIC 3-RING BABY BALL PIT

- Approximate inflated size: 34" x 10" (86cm x 25cm)
- Comes with 50 colorful 2½" (6.5cm) Fun Balz™
- 8ga (0.20mm) rings; 7ga (0.18mm) floor
- Repair patch
- Shelf Box
3 ea, 9.3 lb (4.2 kg)

AGE 1-3



48267NP/EP
JUMP-O-LENE™

- Approximate inflated size: Base inflate to 80" (2.03m) diameter
- Blue, yellow and pink rings
- Transparent pvc material
- Overall height from floor is 27" (69cm)
- Repair patch
- Shelf box
- 120 lb (54 kg) maximum weight limit (2 children maximum)
2 ea, 39.5 lb (18.0 kg)

AGE 3-6



48250NP/EP
**JUMP-O-LENE™ BOXING
RING BOUNCER**

- Approximate inflated size:
89"L x 89"W x 43½"H
(2.26m x 2.26m x 1.10m)
- Includes 2 pairs of boxing gloves
- Inflated base ring and floor for bouncy play
- Crawl-through door
- Transparent sides let parents keep a watchful eye on children
- Repair patch
- Shelf box
- 123 lb (56 kg) maximum weight limit
(2 children maximum)
1 ea. 39.0 lb (17.7 kg)

Age 5-7



48260NP/EP
PLAYHOUSE JUMP-O-LENE™

- Approximate inflated size:
68½" L x 68½" W x 44" H
(1.74m x 1.74m x 1.12m)
- Soft inflatable floor and high walls provide a safe bouncing platform
- Reinforced net surrounding sides
- Crawl-through door
- Repair patch
- Shelf box
- 120 lb (54 kg) maximum weight limit
(2 children maximum)
2 ea, 40.7 lb (18.5 kg)

AGE 3-6



48259NP/EP
JUMP-O-LENE™ CASTLE BOUNCER

- Approximate inflated size: 69" L x 69" W x 53" H
(1.75m x 1.75m x 1.35m)
- Castle with four turrets is great for kids' imaginations and hours of playtime
- Soft inflatable floor and high walls provide a safe bouncing platform
- Repair patch
- Shelf box
- 120 lb (54 kg) maximum weight limit
(2 children maximum)
1 ea, 26.6 lb (12.1 kg)

AGE 3-6

Air Pumps



69611/E
BELLOWS FOOT PUMP

- 11" (28cm)
- TUV RL approved
- Inflates and deflates
- Accordion hose with 3 nozzles
- Shrink wrapped with litho label
- 6 ea, 8.4 lb (3.8 kg)

68610/E
GIANT BELLOWS FOOT PUMP

- 50% more air flow than #69611
- 12" (30cm)
- TUV RL approved
- Inflates and deflates
- Accordion hose with 3 nozzles
- Shelf box
- 6 ea, 13.6 lb (6.2 kg)



68612/E
DOUBLE QUICK I HAND PUMP

- 11½" (29 cm)
- TUV RL approved
- Inflates on both up and down strokes
- Accordion hose with 3 nozzles
- Shelf box
- 12 ea, 11.1 lb (5.0 kg)



68614/E
DOUBLE QUICK II HAND PUMP

- 2 times the air flow of #68612
- 14" (36cm)
- TUV RL approved
- Inflates on both up and down strokes
- Accordion hose with 3 nozzles
- Shelf box
- 4 ea, 6.1 lb (2.8 kg)



68615/E
DOUBLE QUICK III HAND PUMP

- 3½ times the air flow of #68612
- 19" (48cm)
- TUV RL approved
- Large nozzle threaded for athletic ball inflating needle (one included)
- Inflates athletic balls up to 8 psi
- Inflates and deflates
- Pumps on both up and down strokes
- Accordion hose with 4 nozzles
- Shelf box
- 3 ea, 7.8 lb (3.5 kg)



68605/E
DOUBLE QUICK III S
HAND PUMP

- 3 times the air flow of #68612
- 14½" (37cm)
- TUV RL approved
- 3 interconnecting nozzles with hose
- Inflates and deflates
- Inflates on both up and down strokes
- Shelf box
- 3 ea, 6.5 lb (3.0 kg)



69613/E
DOUBLE QUICK MINI HAND PUMP

- 11½" (29cm)
- TUV RL approved
- Inflates on fore and back strokes
- 24 ea, 7.5 lb (3.4 kg)

66633E (110-120V)
66634 (220-240V)

QUICK-FILL™ AC/DC ELECTRIC PUMP

- 3 interconnecting nozzles
- Inflates and deflates
- 12V DC & AC power adapter for easy outdoor and indoor use
- ETL approved (110-120V)
- CE approved (220-240V)
- Shelf box

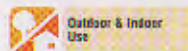

Outdoor & Indoor Use

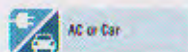

AC or Car

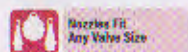

Nozzles Fit Any Valve Size

NEW item



66639E (110-120V)
66640 (220-240V)

QUICK-FILL™ AC ELECTRIC PUMP

- 3 interconnecting nozzles
- Inflates and deflates
- Thermo Protector incorporated for safety
- TUV approved (110-120V)
- GS, CE approved (220-240V)
- Shelf box

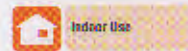

Indoor Use

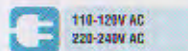

110-120V AC
220-240V AC

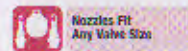

Nozzles Fit Any Valve Size

NEW item



66636/E

QUICK-FILL™ DC ELECTRIC PUMP

- 3 interconnecting nozzles
- Inflates and deflates
- Plug into 12V DC automobile cigarette lighter or 12V DC accessory outlet
- ETL approved
- GS, CE approved
- Shelf box

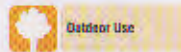

Outdoor Use



12V Car Adapter

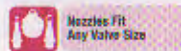

Nozzles Fit Any Valve Size

NEW item



66641E (110-120V) shown
66642 (220-240V)

QUICK-FILL™ RECHARGEABLE ELECTRIC PUMP

- 3 interconnecting nozzles
- A 12V DC power adapter for vehicle charging and a household AC power adapter for home charging
- 12V DC to inflate and deflate while recharging
- Automatic over-charge cut off for safety protection
- New shape with easy carry handle
- ETL approved (110-120V)
- CE approved (220-240V)
- Shelf box



Built-in Rechargeable Battery

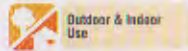

Outdoor & Indoor Use

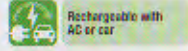

Rechargeable with AC or car

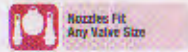

Nozzles Fit Any Valve Size

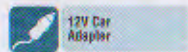

12V Car Adapter

NEW item



66643E (110-120V) shown
66644 (220-240V)

QUICK-FILL™ AC ELECTRIC PUMP

- 3 interconnecting nozzles with hose
- Inflates and deflates
- Thermo protector incorporated for safety
- New shape with easy carry handle
- TUV approved (110-120V model)
- GS, CE approved (220-240V model)
- Shelf box



NEW Item

68608E (110-120V) shown
68609 (220-240V)

QUICK-FILL™ HIGH PSI INDOOR/OUTDOOR ELECTRIC PUMP

- For both indoor and outdoor use — plugs into cigarette lighter or household electrical outlet
- 3 interconnecting nozzles
- Inflates and deflates
- 2 speed switch
- Inflates athletic balls up to 12 psi
- Detachable DC cigarette cord
- ETL approved (110-120V)
- GS, CE approved (220-240V)
- Shelf box



66638/E

QUICK-FILL™ BATTERY PUMP

- 3 interconnecting nozzles
- Battery powered for indoor & outdoor use
- Operates on 6 C-cell size batteries
- Inflates & deflates
- CE approved
- Shelf box



NEW Item

Item #	Voltage		12 DC	Rechargeable		Outdoor Use	Accordion Hose with 3 Nozzles	3 Interconnecting Nozzles	Disposable Batteries: 6 x C	Maximum Air Flow (L/min)	Case Pack	Weight lb (kg)
	110-120 AC	220-240 AC		AC	DC							
66633E	●	-	●	-	-	●	-	●	-	≥480 (17CFM)	6 ea	13.4 (6.1)
66634	-	●	●	-	-	●	-	●	-	>480 (17CFM)	6 ea	13.4 (6.1)
66636/E	-	-	●	-	-	●	-	●	-	≥650 (23CFM)	6 ea	8.5 (3.9)
66639E	●	-	-	-	-	●	-	●	-	≥650 (23CFM)	6 ea	8.8 (4.0)
66640	-	●	-	-	-	●	-	●	-	≥650 (23CFM)	6 ea	8.4 (3.8)
66641E	●	(CHARGING ONLY)	●	●	●	●	-	●	-	≥650 (23CFM)	4 ea	9.5 (4.3)
66642	-	(CHARGING ONLY)	●	●	●	●	-	●	-	≥650 (23CFM)	4 ea	10.2 (4.6)
66643E	●	-	-	-	-	-	●	●	-	≥1100 (38.9CFM)	4 ea	11.3 (5.1)
66644	-	●	-	-	-	-	●	●	-	≥1100 (38.9CFM)	4 ea	11.0 (5.0)
66638/E	-	-	-	-	-	●	-	●	●	>420 (14.8CFM)	6 ea	6.2 (2.8)
68608E	●	-	●	-	-	●	●	-	-	≥400 (14.1CFM)	4 ea	30.3 (13.8)
68609	-	●	●	-	-	●	●	-	-	≥400 (14.1CFM)	4 ea	30.3 (13.8)

Commitment to Excellence

In today's rapidly evolving and highly competitive environment, this translates into a total commitment to product quality, including conformity to all relevant safety & quality regulations and standards. Examples include:

- EN 16927, Safety and test methods for mini pools (European standard)
- EN 16582, Safety and test methods for domestic swimming pools other than mini pools (European standard)
- Regulation (EC) No.1907/2006 "Registration, Evaluation, Authorisation and Restriction of Chemicals (REACH)"
- EN 71 "Safety of toys" (European standard)
- EN 13138 "Buoyant aids for swimming instruction" (European standard)
- EN15649 "Floating leisure articles for use on and in the water" (European standard for air mats, lounges and other similar items)
- EN 60335-2-41 "Safety of household and similar electrical appliances, particular requirements for pumps" (European standard for water pumps)
- Iso 6185-1 "Inflatable boats" (International standard for Sports Boats)
- NMMA-ABYC (USA standard for hi-end sports boats)
- ASTM F963 "Standard Consumer Safety Specification for Toy Safety" (USA toy standard)
- ANSI/APSP-4 "AGP standard" (USA standard for above ground pools)
- CPSIA "Consumer Product Safety Improvement Act"

(USA regulation of consumer and children's products)

- ASTM F2666 "Small pools standard" (USA standard for pools under 36" water depth)
- UL1450 "Electric inflators" (USA standard for electric inflators)
- UL1081 "Swimming pool pumps, filters and chlorinators" (USA standard)
- UL1563 "Electric spas" (USA standard for Spa)

Intex's commitment to excellence extends to helping our environment and supporting the ecosystem. It begins with product design. Intex's filter pumps operate on much lower amps than most filter pumps in the market, reducing electricity consumption. Our saltwater systems clean pools using only natural salt, eliminating the ongoing need for environmentally unfriendly packaged chlorine.

Intex also operates one of the most comprehensive recycling programs in the industry. We are one of the earliest companies in China to successfully obtain a license to ship consumer's returns in the original package back to China to be recycled. Therefore, used materials and product returns are prevented from going to landfills and instead re-used in the manufacturing process where up to 10% of annually produced PVC is recycled.

Intex designs all of our own packaging for our products. We constantly challenge our methods of packaging to improve

efficiency and reduce waste. More compact packaging techniques save cardboard while cutting down on space utilization, saving freight and fuel consumption. As a manufacturer, Intex knows it has a responsibility to manage the amount of waste produced. As an employer of over ten thousand people, we also encourage our own employees to recycle, reduce waste, and be conscious of the environment. Starting from recycling corners for all our worldwide office facilities, our factory has worked with the local government as well as through sponsorships with key partners to strengthen our efforts to be more eco-friendly. Intex has worked to provide incentives and seminars to employees as well as setting targets to reduce energy consumption. In addition, Intex has made significant investment in technology to achieve these goals. For example we have implemented a frequency converter system which converts diesel to natural gas, installed solar water heaters and set up a recycled sewage system, and invested in equipment that reduces gas emissions.

From product design, to more efficient processes that save energy and reduce waste, to a world class recycling program, to more energy efficient offices, the people at Intex are striving to provide the best value products anywhere while constantly keeping our global ecosystem in mind.



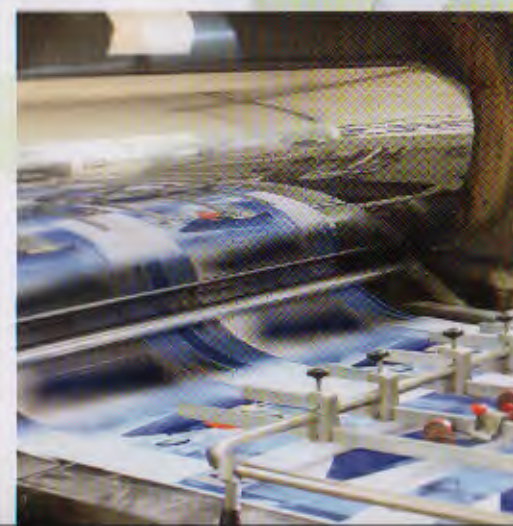

Product Locator Table

ITEM #	DESCRIPTION	PAGE	ITEM #	DESCRIPTION	PAGE	ITEM #	DESCRIPTION	PAGE	ITEM #	DESCRIPTION	PAGE
44669	3-D BOP BAG	105	55977	SPORT MASK	78	57160	PLAY CENTER	47	58355	EXPLORER™ PRO 100	87
44672	3-D BOP BAG	105	55978	SPORT MASK	78	57161	PLAY CENTER	45	58356	EXPLORER™ PRO 200	87
45642	PLAY TENT	106	55981	PRO MASK	81	57162	PLAY CENTER	46	58357	EXPLORER™ PRO SET	87
48250	JUMP-O-LENE™	110	55991	SWIM CAP	81	57173	MINI FRAME™ POOL	63	58358	EXPLORER™ PRO SET	87
48259	JUMP-O-LENE™	111	56268	45" TRUCK TUBE	23	57181	SWIM CENTER™	69	58412	POOL COVER	71
48260	JUMP-O-LENE™	111	56280	INFLATABULL™	37	57182	SWIM CENTER™	68	58426	CRYSTAL POOL	63
48267	JUMP-O-LENE™	109	56441	SUNSET POOL	62	57190	SWIM CENTER™	71	58431	SOFT SIDE POOL	63
48476	BABY GYM	106	56451	5' X 10" SNAPSET™	65	57198	SWIM CENTER™	70	58439	DOTS POOL	61
48635	PLAY HOUSE	108	56452	6' X 15" SNAPSET™	65	57403	RECTANGULAR POOL	63	58446	CRYSTAL POOL	63
48674	BALL TOYZ™	109	56475	SWIM CENTER™	70	57412	SUNSET POOL	62	58448	WATERMELON POOL	62
49600	FUN BALLZ™	106	56483	SWIM CENTER™	69	57422	SUNSET POOL	62	58449	DOTS POOL	61
49602	FUN BALLZ™	106	56490	SWIM CENTER™	71	57440	SPRAY POOL	64	58472	8' X 18" SNAPSET™	65
55503	UNDERWATER BALL	12	56493	OCEAN POOL	67	57441	SPRAY POOL	64	58477	4' X 10" SNAPSET™	65
55504	UNDERWATER STICK	12	56495	SUMMER POOL	68	57444	PLAY CENTER	50	58480	AQUA POOL	66
55507	UNDERWATER RING	12	56508	VOLLEYBALL GAME	43	57453	PLAY CENTER	51	58484	SWIM CENTER™	69
55601	PLAY GOGGLE	74	56514	PRINCESS CARRIAGE	42/107	57470	SUN SHADE POOL	67	58485	SWIM CENTER™	69
55602	PLAY GOGGLE	74	56581	BABY FLOAT	15	57471	AQUARIUM POOL	66	58504	FLOATING HOOPS	43
55603	PLAY GOGGLE	75	56584	BABY FLOAT	15	57482	OVAL POOL	66	58507	GOALS GAME	42
55609	EAR PLUGS SET	80	56585	BABY FLOAT	14	57495	SWIM CENTER™	68	58523	LIL' WHALE	41
55634	M SPORT FINS	80	56587	BABY FLOAT	9	57520	WAVE RIDER	40	58535	LIL' DOLPHIN	41
55635	L SPORT FINS	80	56588	BABY FLOAT	14	57524	LIL' SEA TURTLE	40	58546	LIL' GATOR	41
55642	SWIM GEAR SET	75	56590	BABY FLOAT	14	57525	WHITE SHARK	38	58561	WHALE	41
55647	SWIM GEAR SET	78	56643	ARM BANDS	9	57533	LOBSTER	39	58562	GIANT GATOR	41
55648	SWIM GEAR SET	78	56800	DOUBLE LOUNGE	30	57537	WATER GUN PLANE	40	58590	PUFF 'N PLAY™	13
55655	SWIM GEAR SET	75	56822	MEGA CHILL	32	57550	STINGRAY	39	58641	ARM BANDS	10
55657	SWIM GEAR SET	80	56825	RIVER RUN™ 1	33	57551	REALISTIC GATOR	38	58642	ARM BANDS	10
55658	SWIM GEAR SET	80	56841	GIANT FLOATING MAT	35	57555	SEA TURTLE	38	58652	ARM BANDS	10
55682	SPORT GOGGLE	78	56897	DOUBLE LOUNGE MAT	29	58152	SURF'S UP MAT	25	58660	SWIM VEST	9
55684	SPORT GOGGLE	78	57100	BABY POOL	56	58165	JOY RIDER	17	58671	SWIM VEST	10
55685	SPORT GOGGLE	78	57104	BABY POOL	57	58167	KICKBOARD	9	58802	KING KOOL™	28
55691	PRO GOGGLE	80	57106	BABY POOL	57	58202	48" COLOR TUBE	22	58807	TOTE 'N FLOAT™	26
55692	PRO GOGGLE	81	57107	BABY POOL	57	58221	SWIM RING	18	58821	MEGA CHILL 2	32
55915	PLAY MASK	76	57111	BABY POOL	59	58231	20" SWIM RING	9	58825	RIVER RUN™ 1	33
55916	PLAY MASK	76	57114	BABY POOL	58	58263	38" TUBE	20	58836	MESH MAT	34
55922	PLAY SNORKEL	75	57122	BABY POOL	58	58292	CANOPY ISLAND	35	58837	RIVER RUN™ 2	32
55924	PRO SNORKEL	81	57124	BABY POOL	56	58294	ISLAND WITH SLIDE	43	58849	WATER SLIDE	53
55928	SPORT SNORKEL	78	57129	PLAY CENTER	49	58329	EXPLORER™ 100	86	58854	CONNECT LOUNGE	32
55936	S SWIM FINS	76	57135	PLAY CENTER	52	58330	EXPLORER™ 200	86	58856	ROCKIN' LOUNGE	28
55937	M SWIM FINS	76	57141	BABY POOL	59	58331	EXPLORER™ 200 SET	86	58859	SIT 'N FLOAT	29
55944	SWIM GEAR SET	75	57149	PLAY CENTER	48	58332	EXPLORER™ 300	86	58868	RECLINER	34
55962	SWIM GEAR SET	81	57159	SURF 'N SLIDE	54	58354	EXPLORER™ PRO 50	87	58883	SIT 'N LOUNGE™	21

Product Locator Table

ITEM #	DESCRIPTION	PAGE	ITEM #	DESCRIPTION	PAGE
58889	PILLOW-BACK	29	66634	230V PUMP	114
58890	18-POCKET	27	66636	12V PUMP	114
58894	18-POCKET	27	66638	BATTERY PUMP	114
58924	BABY POOL	57	66639	120V PUMP	114
59020	20" BEACH BALL	16	66640	230V PUMP	114
59030	24" BEACH BALL	16	66641	120V PUMP	114
59040	20" BEACH BALL	16	66642	230V PUMP	114
59065	42" BEACH BALL	16	66643	120V PUMP	114
59220	SWIM RING	18	66644	230V PUMP	114
59230	20" SWIM RING	18	68209	48" RIVER RAT™	23
59241	24" SWIM RING	18	68305	CHALLENGER™ K1	94
59242	24" SWIM RING	19	68306	CHALLENGER™ K2	94
59251	36" TUBE	20	68307	EXPLORER™ K2	97
59252	36" TUBE	22	68309	EXCURSION™ PRO K2	99
59256	36" TUBE	21	68324	EXCURSION™ 4 SET	93
59258	30" TUBE	19	68325	EXCURSION™ 5 SET	93
59260	30" TUBE	19	68347	SEAHAWK™ 2 SET	90
59262	36" TUBE	20	68351	SEAHAWK™ 4 SET	90
59380	POOL CRUISER	17	68367	CHALLENGER™ 2 SET	89
59409	MY FIRST POOL	57	68370	CHALLENGER™ 3 SET	89
59416	CRYSTAL POOL	63	68373	MARINER™ 3 SET	101
59421	FRUITY POOL	60	68376	MARINER™ 4 SET	103
59431	FISHBOWL POOL	61	68380	SEAHAWK™ 3 SET	90
59460	FRUITY POOL SET	60	68556	CHAIR ASST.	105
59469	FISHBOWL POOL SET	61	68605	HAND PUMP	113
59570	POOL RIDER	17	68608	120V PUMP	115
59574	BABY FLOAT	14	68609	230V PUMP	115
59586	KIDDIE FLOAT	15	68610	FOOT PUMP	113
59623	FRENCH OARS	84	68612	HAND PUMP	113
59631	REPAIR PATCH	71	68614	HAND PUMP	113
59632	REPAIR KIT	71	68615	HAND PUMP	113
59640	ARM BANDS	10	68624	MOTOR MOUNT	84
59642	ARM BANDS	10	68631	BATTERY MOTOR	84
59650	ARM BANDS	10	69611	FOOT PUMP	113
59661	SWIM VEST	10	69613	HAND PUMP	113
59703	ECONOMAT	25	69627	KAYAK PADDLES	84
59717	NEON MAT	25			
59720	FASHION MAT	24			
59894	18-POCKET	28			
59895	18-POCKET	26			
66633	120V PUMP	114			

All Intex products in this catalog are manufactured from 6P Free PVC, which contains less than 0.1% (1,000ppm) of the following 6 phthalates: DEhp, DBP, BBP, DINP, DIDP and DNOP.



EU: Select arm bands, swim vests, baby floats and kickboards may include a notation suffix "EU". These products are in compliance with European EN13138-1/2/3 "Buoyant aids for swimming instructions" standard. Select tubes, air mats, lounges and islands may include a notation suffix "EU". These products are in compliance with European EN ISO 25649-1/2/3/4 "Floating leisure articles for use on and in the water" standard.

As a part of our program of product development and improvement, the detail specifications of the products shown in this catalog may be changed. For current specifications on any product, please contact your supplier of Intex products.

AGE GRADING

 Age 3-6

An icon indicates an item has an age recommendation.

PRODUCT SIZES

Except for pools, boats and In Toyz® approximate deflated dimensions are shown.

PACKAGING

Unless indicated otherwise, each product is packed in a polybag with a full-color insert.

TRADEMARKS

®™ Trademarks used in some countries of the world under license from Intex Marketing Ltd. to Intex Development Co. Ltd. and Intex Recreation Corp.



INTERNATIONAL

Intex Development Co., Ltd.
9th Floor, Everbright Centre,
108 Gloucester Road, Wanchai,
Hong Kong
Tel: (852) 2827-0000
Fax: (852) 2311-8200
E-mail: info@intexdevelopment.com
Web: www.intexdevelopment.com

EUROPE

Intex Trading B.V.
Venneveld 9,
4705 RR Roosendaal,
The Netherlands
Tel: (31) 165-593920
Fax: (31) 165-593969
E-mail: info@intexcorp.nl
Web: www.intexcorp.nl

USA

Intex Recreation Corp.
P.O. Box 1440,
Long Beach, CA 90801-1440, USA
Tel: (310) 549-5400
Fax: (310) 513-6905
Web: www.intexcorp.com

Intex Trading s.r.o.
Benešovská 23
101 00 Praha 10
Czech Republic
Tel: (420) 267 312 645
Fax: (420) 267 312 552
E-mail: info@intexcorp.cz
Web: www.intexdevelopment.com

Unitex Service (France) S.A.S.
Z.A. de Milleure Bois du Ban - N°4
71480 LE MIROIR, France
Tel: (33) 385 75 64 64
Fax: (33) 385 75 64 65
E-mail: info@intexcorp.com.fr
Web: www.intex.fr

INTEX[®]

©2018 Intex Marketing Ltd. - Intex Development Co., Ltd. - Intex Recreation Corp. All rights reserved. Printed in China.
*™ Trademarks used in some countries of the world under license from Intex Marketing Ltd. to Intex Development Co., Ltd.,
G.P.O Box 28829, Hong Kong, and Intex Recreation Corp., P.O. Box 1440, Long Beach, CA 90801.

